

Changes for the Better

MITSUBISHI CNC

Instruction Manual
M800/M80/E80 Series

A grayscale image of the Earth from space, showing continents and clouds. Overlaid on the center of the Earth is the text "MITSUBISHI CNC" in a large, white, stylized font. The text is partially obscured by a semi-transparent, curved band that follows the curvature of the globe.

**MITSUBISHI
CNC**

Introduction

This manual is a guide for using the MITSUBISHI CNC M800/M80/E80 Series.

Supported models are as follows:

Supported models	Details
M800W Series	M850W, M830W
M800S Series	M850S, M830S
M80W Series	M80W
M80 Series	M80 TypeA, M80 TypeB
E80 Series	E80 TypeA, E80 TypeB

Abbreviations in this manual are as follows:

Abbreviations	Supported models
M800, M800 Series	M800W Series/M800S Series
M80, M80 Series	M80 Series/M80W Series
M800/M80, M800/M80 Series	M800W Series/M800S Series/M80W Series/M80 Series
M8, M8 Series	M800W Series/ M800S Series/M80W Series/M80 Series/E80 Series

This manual describes operations, production processes and maintenances for users who operate the MITSUBISHI CNC installed machine tool. Read this manual thoroughly before using CNC unit. Moreover study the "Precautions for Safety" on the next page before use to use the unit safely. Be sure to keep this manual always at hand.

CAUTION

- ⚠ For items described as "Restrictions" or "Usable State" in this manual, the instruction manual issued by the machine tool builder (MTB) takes precedence over this manual.
- ⚠ Items not described in this manual must be interpreted as "not possible".
- ⚠ This manual is written on the assumption that all the applicable functions are included. Some of them, however, may not be available for your NC system. Refer to the specifications issued by the machine tool builder before use.
- ⚠ Refer to the Instruction Manual issued by each MTB for details on each machine tool.
- ⚠ Some screens and functions may differ depending on the NC system (or its version), and some functions may not be possible. Please confirm the specifications before use.
- ⚠ Do not connect NC system to the Internet-connected network.
- ⚠ To maintain the safety of the NC system against unauthorized access from external devices via the network, take appropriate measures.

In this manual, the following abbreviations might be used.

L system: Lathe system

M system: Machining center system

MTB: Machine tool builder

Also refer to the manuals on "Manual List" as necessary.

Manual List

Manuals related to M800/M80/E80/C80 Series are listed as follows.

These manuals are written on the assumption that all optional functions are added to the targeted model.

Some functions or screens may not be available depending on the machine or specifications set by MTB. (Confirm the specifications before use.)

The manuals issued by MTB take precedence over these manuals.

Manual	IB No.	Purpose and Contents
M800/M80/E80 Series Instruction Manual	IB-1501274	<ul style="list-style-type: none"> ◆ Operation guide for NC ◆ Explanation for screen operation, etc.
C80 Series Instruction Manual	IB-1501453	<ul style="list-style-type: none"> ◆ Operation guide for NC ◆ Explanation for screen operation, etc.
M800/M80/E80/C80 Series Programming Manual (Lathe System) (1/2)	IB-1501275	<ul style="list-style-type: none"> ◆ G code programming for lathe system ◆ Basic functions, etc.
M800/M80/E80/C80 Series Programming Manual (Lathe System) (2/2)	IB-1501276	<ul style="list-style-type: none"> ◆ G code programming for lathe system ◆ Functions for multi-part system, high-accuracy function, etc.
M800/M80/E80/C80 Series Programming Manual (Machining Center System) (1/2)	IB-1501277	<ul style="list-style-type: none"> ◆ G code programming for machining center system ◆ Basic functions, etc.
M800/M80/E80/C80 Series Programming Manual (Machining Center System) (2/2)	IB-1501278	<ul style="list-style-type: none"> ◆ G code programming for machining center system ◆ Functions for multi-part system, high-accuracy function, etc.
M800/M80/E80 Series Alarm/Parameter Manual	IB-1501279	<ul style="list-style-type: none"> ◆ Alarms ◆ Parameters
C80 Series Alarm/Parameter Manual	IB-1501560	<ul style="list-style-type: none"> ◆ Alarms ◆ Parameters

Manuals for MTBs (NC)

Manual	IB No.	Purpose and Contents
M800/M80/E80/C80 Series Specifications Manual (Function)	IB-1501505	<ul style="list-style-type: none"> ♦ Model selection ♦ Outline of various functions
M800/M80/E80/C80 Series Specifications Manual (Hardware)	IB-1501506	<ul style="list-style-type: none"> ♦ Model selection ♦ Specifications of hardware unit
M800W/M80W Series Connection and Setup Manual	IB-1501268	<ul style="list-style-type: none"> ♦ Detailed specifications of hardware unit ♦ Installation, connection, wiring, setup (startup/adjustment)
M800S/M80/E80 Series Connection and Setup Manual	IB-1501269	<ul style="list-style-type: none"> ♦ Detailed specifications of hardware unit ♦ Installation, connection, wiring, setup (startup/adjustment)
C80 Series Connection and Setup Manual	IB-1501452	<ul style="list-style-type: none"> ♦ Detailed specifications of hardware unit ♦ Installation, connection, wiring, setup (startup/adjustment)
M800/M80/E80 Series PLC Development Manual	IB-1501270	<ul style="list-style-type: none"> ♦ Electrical design ♦ I/O relation (assignment, setting, connection), field network ♦ Development environment (PLC on-board, peripheral development environment), etc.
M800/M80/E80 Series PLC Programming Manual	IB-1501271	<ul style="list-style-type: none"> ♦ Electrical design ♦ Sequence programming ♦ PLC support functions, etc.
M800/M80/E80/C80 Series PLC Interface Manual	IB-1501272	<ul style="list-style-type: none"> ♦ Electrical design ♦ Interface signals between NC and PLC
M800/M80/E80 Series Maintenance Manual	IB-1501273	<ul style="list-style-type: none"> ♦ Cleaning and replacement for each unit ♦ Other items related to maintenance
C80 Series Maintenance Manual	IB-1501454	<ul style="list-style-type: none"> ♦ Cleaning and replacement for each unit ♦ Other items related to maintenance

Manuals for MTBs (drive section)

Manual	IB No.	Contents
MDS-E/EH Series Specifications Manual	IB-1501226	<ul style="list-style-type: none"> ♦ Specifications for power supply regeneration type
MDS-E/EH Series Instruction Manual	IB-1501229	<ul style="list-style-type: none"> ♦ Instruction for power supply regeneration type
MDS-EJ/EJH Series Specifications Manual	IB-1501232	<ul style="list-style-type: none"> ♦ Specifications for regenerative resistor type
MDS-EJ/EJH Series Instruction Manual	IB-1501235	<ul style="list-style-type: none"> ♦ Instruction for regenerative resistor type
MDS-EM/EMH Series Specifications Manual	IB-1501238	<ul style="list-style-type: none"> ♦ Specifications for multi-hybrid, power supply regeneration type
MDS-EM/EMH Series Instruction Manual	IB-1501241	<ul style="list-style-type: none"> ♦ Instruction for multi-hybrid, power supply regeneration type
DATA BOOK	IB-1501252	<ul style="list-style-type: none"> ♦ Specifications of servo drive unit, spindle drive unit, motor, etc.

Manuals for MTBs (Others)

Manual	No.	Purpose and Contents
GOT2000 Series User's Manual (Hardware)	SH-081194	♦ Outline of hardware such as part names, external dimensions, installation, wiring, maintenance, etc. of GOTs
GOT2000 Series User's Manual (Utility)	SH-081195	♦ Outline of utilities such as screen display setting, operation method, etc. of GOTs
GOT2000 Series User's Manual (Monitor)	SH-081196	♦ Outline of each monitor function of GOTs
GOT2000 Series Connection Manual (Mitsubishi Electric Products)	SH-081197	♦ Outline of connection types and connection method between GOT and Mitsubishi Electric connection devices
GT Designer3 (GOT2000) Screen Design Manual	SH-081220	♦ Outline of screen design method using screen creation software GT Designer3

■ For M800/M80/E80 Series

Manual	No.	Purpose and Contents
GOT2000/GOT1000 Series CC-Link Communication Unit User's Manual	IB-0800351	♦ Explanation for handling CC-Link communication unit (for GOT2000 series/GOT1000 series)
GX Developer Version 8 Operating Manual (Startup)	SH-080372E	♦ Explanation for system configuration, installation, etc. of PLC development tool GX Developer
GX Developer Version 8 Operating Manual	SH-080373E	♦ Explanation for operations using PLC development tool GX Developer
GX Converter Version 1 Operating Manual	IB-0800004E	♦ Explanation for operations using data conversion tool GX Converter
GX Works2 Installation Instructions	BCN-P5999-0944	♦ Explanation for the operating environment and installation method of GX Works2
GX Works2 Version 1 Operating Manual (Common)	SH-080779ENG	♦ Explanation for the system configuration of GX Works2 and the functions common to Simple project and Structured project such as parameter setting, operation method for the online function
GX Works2 Version 1 Operating Manual (Simple Project)	SH-080780ENG	♦ Explanation for methods for such as creating and monitoring programs in Simple project of GX Works2
GX Works2 Version 1 Operating Manual (Simple Project, Function Block)	SH-080984ENG	♦ Explanation for methods for such as creating function blocks, pasting function blocks to sequence programs, and operating FB library in Simple project of GX Works2
GX Works2 Version 1 Operating Manual (Structured Project)	SH-080781ENG	♦ Explanation for methods for such as creating and monitoring programs in Structured project of GX Works2
GX Works3 Installation Instructions	BCN-P5999-0391	♦ Explanation for the operating environment and installation method of GX Works3
MELSEC-Q CC-Link System Master/Local Module User's Manual	SH-080394E	♦ Explanation for system configuration, installation, wiring, etc. of master/local modules for CC-Link system
GOT2000 Series Connection Manual (Non-Mitsubishi Electric Products 1)	SH-081198ENG	♦ Explanation for connection types and connection method between GOT and other company's devices
GOT2000 Series Connection Manual (Non-Mitsubishi Electric Products 2)	SH-081199ENG	
GOT2000 Series Connection Manual (Microcomputers, MODBUS/Fieldbus Products, Peripherals)	SH-081200ENG	♦ Explanation for connection types and connection method between GOT and microcomputers, MODBUS/fieldbus products, peripherals
GT SoftGOT2000 Version1 Operating Manual	SH-081201ENG	♦ Explanation for system configuration, screen configuration and operation method of monitoring software GT SoftGOT2000

■ For C80 Series

Manual	No.	Purpose and Contents
MELSEC iQ-R Module Configuration Manual	SH-081262	♦ Outline of system configuration, specifications, installation, wiring, maintenance, etc.
MELSEC iQ-R CPU Module User's Manual (Startup)	SH-081263	♦ Outline of specifications, procedures before operation, troubleshooting, etc. for CPU module
MELSEC iQ-R CPU Module User's Manual (Application)	SH-081264	♦ Outline of memory, functions, devices, parameters, etc. for CPU module
QCPU User's Manual (Hardware Design, Maintenance and Inspection)	SH-080483	♦ Outline of specifications, necessary knowledge to configure the system and maintenance-related descriptions for Q series CPU module, etc.
GX Works3 Operating Manual	SH-081215	♦ Outline of functions, programming, etc.

Reference Manual for MTBs

Manual	No.	Purpose and Contents
M800/M80 Series Smart safety observation Specification manual	BNP-C3072-022	♦ Explanation for smart safety observation function
C80 Series Smart safety observation Specification manual	BNP-C3077-022	
M800/M80 Series CC-Link (Master/Local) Specification manual	BNP-C3072-089	♦ Explanation for CC-Link
M800/M80 Series PROFIBUS-DP Specification manual	BNP-C3072-118	♦ Explanation for PROFIBUS-DP communication function
M800/M80 Series Interactive cycle insertion (Customization) Specification manual	BNP-C3072-121-0003	♦ Explanation for interactive cycle insertion
M800/M80 Series EtherNet/IP Specifications manual	BNP-C3072-263	♦ Explanation for EtherNet/IP
M800/M80 Series CC-Link IE Field (Master/local) Specifications manual	BNP-C3072-283	♦ Explanation for CC-Link IE Field
M800/M80 Series GOT Connection Specifications manual	BNP-C3072-314	♦ Explanation for GOT connection
M800/M80 Series CC-Link IE Field Basic Specifications manual	BNP-C3072-337	♦ Explanation for CC-Link IE Field Basic

Precautions for Safety

Always read the specifications issued by the MTB, this manual, related manuals and attached documents before installation, operation, programming, maintenance or inspection to ensure correct use. Understand this numerical controller, safety items and cautions before using the unit.

This manual ranks the safety precautions into "DANGER", "WARNING" and "CAUTION".

DANGER

When the user may be subject to imminent fatalities or major injuries if handling is mistaken.

WARNING

When the user may be subject to fatalities or major injuries if handling is mistaken.

CAUTION

When the user may be subject to bodily injury or when physical damage may occur if handling is mistaken.

Note that even items ranked as " CAUTION", may lead to major results depending on the situation. In any case, important information that must always be observed is described.

The following signs indicate prohibition and compulsory.



This sign indicates prohibited behavior (must not do).

For example, "Keep fire away" is indicated by .



This sign indicates a thing that is critical (must do).

For example, "it must be grounded" is indicated by .

The meaning of each pictorial sign is as follows.

 CAUTION	 CAUTION rotate object	 CAUTION HOT	 Danger Electric shock risk	 Danger explosive
 Prohibited	 Disassembly is prohibited	 KEEP FIRE AWAY	 General instruction	 Earth ground



For Safe Use

MITSUBISHI CNC is designed and manufactured solely for applications to machine tools to be used for industrial purposes. Do not use this product in any applications other than those specified above, especially those which are substantially influential on the public interest or which are expected to have significant influence on human lives or properties.

DANGER







Not applicable in this manual.

WARNING

-  If the operation start position is set from a block in the program and the program is started, the program before the set block is not executed. Please confirm that G and F modal and coordinate values are appropriate. If there are coordinate system shift commands or M, S, T and B commands before the block set as the start position, carry out the required commands using the MDI, etc. If the program is run from the set block without carrying out these operations, there is a danger of interference with the machine or of machine operation at an unexpected speed, which may result in breakage of tools or machine tool or may cause damage to the operators.
-  Under the constant surface speed control (during G96 modal), if the axis targeted for the constant surface speed control moves toward the spindle center, the spindle rotation speed will increase and may exceed the allowable speed of the workpiece or chuck, etc. In this case, the workpiece, etc. may jump out during machining, which may result in breakage of tools or machine tool or may cause damage to the operators.

CAUTION



1. Items related to product and manual

-  For items described as "Restrictions" or "Usable State" in this manual, the instruction manual issued by the machine tool builder (MTB) takes precedence over this manual.
-  Items not described in this manual must be interpreted as "not possible"
-  This manual is written on the assumption that all the applicable functions are included. Some of them, however, may not be available for your NC system. Refer to the specifications issued by the machine tool builder before use.
-  Refer to the Instruction Manual issued by each MTB for details on each machine tool.
-  Some screens and functions may differ depending on the NC system (or its version), and some functions may not be possible. Please confirm the specifications before use.
-  Do not connect NC system to the Internet-connected network.
-  To maintain the safety of the NC system against unauthorized access from external devices via the network, take appropriate measures.





2. Items related to installation and assembly

-  Ground the signal cables to ensure stable system operation. Also ground the NC unit main frame, power distribution panel and machine to one point, so they all have the same potential.





3. Items related to preparation before use

-  Always set the stored stroke limit. Failure to set this could result in collision with the machine end.
-  Always turn the power OFF before connecting/disconnecting the input/output device cable. Failure to do so could damage the input/output device and NC unit.



4. Items related to screen operation

-  Always keep the touchscreen surface clean. When it gets dirty, remove the dirt immediately. Do not perform any operation on the dirty touchscreen.
-  If the tool compensation amount or workpiece coordinate system offset amount is changed during automatic operation (including during single block stop), the changes will be valid from the command in next block or after several subsequent blocks.
-  All of the various data in the NC memory is erased when formatting. Be sure to use the transfer function to transfer all necessary data to another storage device before formatting.
-  Even if the tool compensation amount write command, parameter write command or variable data write command is executed with graphic check, the data will be actually written in, and the original data will be overwritten.
-  Pay close attention to the sequence operation when carrying out forced data setting (forced output) in the I/F diagnosis screen during machine operation.





CAUTION

-  Selected machining surface is not canceled even when NC reset is executed, the coordinate system defined along the machining target surface (feature coordinate system) remains selected.
It depends on the setting of the parameter "#1247 set19/bit2" (Inclined surface machining mode hold) to hold or cancel the selected machining surface at the emergency stop state. However, selected machining surface is not held when the power is turned OFF.
Press the menu [Surface cancel] to cancel the selected machining surface. The operating coordinate system will be back to the machine coordinate system by canceling the machining surface.
-  The program including a character of any language other than the display language is not correctly displayed. Do not edit such a program. Any part of the program other than the comment part may also be changed if edited.
-  To prevent influence from data omission and data transformation in the communication circuit, always verify the data after inputting and outputting machining programs.
-  Do not change setup parameters without prior approval from the MTB.





5. Items related to programming

-  If there is no value after the G command, the operation will be the "G00" operation when the program is run due to key chattering, etc., during editing.
-  "; ", "EOB", "%", and "EOR" are symbols used for explanation. The actual codes for ISO are "CR, LF" ("LF") and "%". "% and "EOR" are represented by "%" in ISO.
The programs created on the edit screen are stored in the NC memory in a "CR, LF" format, however, the programs created with external devices may be stored in an "LF" format.
The actual codes for EIA are "EOB (End of Block)" and "EOR (End of Record)".
-  Do not change the fixed cycle program without prior approval from the MTB.



6. Items related to operation

-  Do not enter the machine's movable range during automatic operation. During rotation, keep your hands, feet and face away from the spindle.
-  Carry out dry operation before actually machining, and confirm the machining program, tool offset and workpiece coordinate system offset.
-  If the operation start position is set from a block in the program and the program is started, the program before the set block is not executed. If there are coordinate system shift commands or M, S, T, and B commands before the block set as the starting position, carry out the required commands using the MDI, etc. There is a danger of interference with the machine if the operation is started from the set starting position block without carrying out these operations.
-  Program so the mirror image function is turned ON/OFF at the mirror image center. The mirror image center will deviate if the function is turned ON/OFF at a position other than the mirror image center.

7. Items related to faults and abnormalities

-  If the battery low warning is issued, save the machining programs, tool data and parameters in an input/output device, and then replace the battery. When the battery alarm is issued, the machining programs, tool data and parameters may be destroyed. Reload the data after replacing the battery.
-  If the battery low warning is issued in the drive unit side, immediately replace the battery. Replace the batteries while applying the drive unit's control power.
-  If the axis overruns or emits an abnormal noise, immediately press the emergency stop button and stop the axis movement.
-  Turn OFF the power immediately if any smoke, abnormal noise or odor is generated from the controller, drive unit or motor.

8. Items related to maintenance

-  Incorrect connections may damage the devices. Always connect the cables to the indicated connectors.
-  Do not apply voltages other than those indicated according to specification on the connector. Failure to observe this could cause bursting, damage, etc.
-  Do not connect or disconnect the connection cables between each unit while the power is ON.

 **CAUTION**

- ⊘ Do not connect or disconnect the PCBs while the power is ON.
- ⊘ Do not connect the cable by pulling on the cable wire.
- ⚠ Do not short circuit, charge, overheat, incinerate or disassemble the battery.
- ⚠ Dispose the spent battery according to local laws.
- ⚠ Dispose the spent cooling fan according to local laws.
- ⚠ Do not replace the control unit while the power is ON.
- ⚠ Do not replace the operation panel I/O unit while the power is ON.
- ⚠ Do not replace the control section power supply PCB while the power is ON.
- ⚠ Do not replace the expansion PCB while the power is ON.
- ⚠ Do not replace the memory cassette while the power is ON.
- ⚠ Do not replace the cooling fan while the power is ON.
- ⚠ Do not replace the battery while the power is ON.
- ⚠ Be careful that metal cutting chips, etc., do not come into contact with the connector contacts of the memory cassette.
- ⚠ Do not replace the high-speed program server unit while the power is ON.
- ⚠ Before touching the unit, always touch a metal with a ground section to discharge any static electricity in the human body etc. If static electricity is not discharged, the breakdown and the malfunction of the unit are caused.
- ⚠ When connecting to a personal computer and a unit with the RS-232C/USB interface, an electric shock or a unit failure may occur. It depends on the type of computer to be connected, or the use environment.
Operate these correctly according to the manual of a unit and a personal computer.
Observe the following cautions when a personal computer in an AC power supply is used.
 - (1) For a personal computer that uses a 3-pin power plug or power plug with a ground lead type, make sure to use a plug socket including a ground input electrode or ground the earth lead, respectively.
 - (2) For a personal computer that uses a 2-pin power plug without ground lead, make sure to connect the unit to the personal computer according to the following procedures. And, it is recommended to supply the same power supply line to a personal computer and the unit.
 - (a) Pull out the power plug of the personal computer from the AC outlet.
 - (b) Confirm that the power plug of the personal computer has been pulled out from the AC outlet, and connect RS-232/USB cables.
 - (c) Insert the power plug of the personal computer into the AC outlet.
- ⚠ Before using this product after a long period of storage, performance check must be conducted. Otherwise contact the MTB of your machine tool.

 **CAUTION**

9. Other items

 **MITSUBISHI CNC should be operated and stored under the following environment conditions. Refer to the instruction manual issued by the MTB for details of the environment conditions for the machine tool including the CNC unit.**

Unit name		Control unit		Display unit	Keyboard unit	Operation panel I/O unit
Ambient temperature	During operation	0 to 55°C (M800W/M80W Series)	0 to 58°C (M800S/M80/E80 Series)	0 to 58 °C		
	During storage	-20 to 60 °C				
Ambient Humidity	Long term	10 to 75% RH (with no dew condensation)				
	Short term (*1)	10 to 95% RH (with no dew condensation)				
Vibration resistance		4.9m/s ² [0.5G] or less				
Shock resistance		29.4m/s ² [3G] or less				
Operating atmosphere		No corrosive gases, dust or oil mist				
Altitude		Operation/Storage: 1000 meters or less above sea level, Transportation: 13000 meters or less above sea level				

(*1) "Short term" means within one month.

Note

- (1) For the whole NC system, consider the characteristics of the drive units when the altitude is more than 1000 meters above sea level.
Refer to the manual of drive unit for details.

Treatment of waste

The following two laws will apply when disposing of this product. Considerations must be made to each law. The following laws are in effect in Japan. Thus, when using this product overseas, the local laws will have a priority. If necessary, indicate or notify these laws to the final user of the product.

- (1) Requirements for "Law for Promotion of Effective Utilization of Resources"
 - (a) Recycle as much of this product as possible when finished with use.
 - (b) When recycling, often parts are sorted into steel scraps and electric parts, etc., and sold to scrap contractors. Mitsubishi recommends sorting the product and selling the members to appropriate contractors.

- (2) Requirements for "Law for Treatment of Waste and Cleaning"
 - (a) Mitsubishi recommends recycling and selling the product when no longer needed according to item (1) above. The user should make an effort to reduce waste in this manner.
 - (b) When disposing a product that cannot be resold, it shall be treated as a waste product.
 - (c) The treatment of industrial waste must be commissioned to a licensed industrial waste treatment contractor, and appropriate measures, including a manifest control, must be taken.
 - (d) Batteries correspond to "primary batteries", and must be disposed of according to local disposal laws.

Disposal



(Note) This symbol mark is for EU countries only.
This symbol mark is according to the directive 2006/66/EC Article 20 Information for end-users and Annex II.

Your MITSUBISHI ELECTRIC product is designed and manufactured with high quality materials and components which can be recycled and/or reused.

This symbol means that batteries and accumulators, at their end-of-life, should be disposed of separately from your household waste.

If a chemical symbol is printed beneath the symbol shown above, this chemical symbol means that the battery or accumulator contains a heavy metal at a certain concentration. This will be indicated as follows:

Hg: mercury (0,0005%), Cd: cadmium (0,002%), Pb: lead (0,004%)

In the European Union there are separate collection systems for used batteries and accumulators. Please, dispose of batteries and accumulators correctly at your local community waste collection/recycling centre.

Please, help us to conserve the environment we live in!

Trademarks

MELDAS, MELSEC, EZSocket, EZMotion, iQ Platform, MELSEC iQ-R, MELSOFT, GOT, CC-Link, CC-Link/LT, CC-Link IE, CC-Link IE/field, EcoMonitorLight and SLMP are either trademarks or registered trademarks of Mitsubishi Electric Corporation in Japan and/or other countries.

Ethernet is a registered trademark of Xerox Corporation in the United States and/or other countries.

Microsoft®, Windows®, SQL Server® and Access® are either trademarks or registered trademarks of Microsoft Corporation in the United States and/or other countries.

SD logo and SDHC logo are either registered trademarks or trademarks of LLC.

UNIX is a registered trademark of The Open Group in the United States and/or other countries.

Intel® and Pentium® are either trademarks or registered trademarks of Intel Corporation in the United States and/or other countries.

MODBUS® is either a trademark or a registered trademark of Schneider Electric USA, Inc. or the affiliated companies in Japan and/or other countries.

EtherNet/IP is a trademark of Open DeviceNet Vendor Association, Inc.

PROFIBUS-DP and PROFINET are either trademarks of Profibus International.

Oracle® is a registered trademark of Oracle Corporation, the subsidiaries, or the affiliated companies in the United States and /or other countries.

VNC is a registered trademark of RealVNC Ltd. in the United States and other countries.

Other company and product names that appear in this manual are trademarks or registered trademarks of the respective companies.

本製品の取扱いについて

(日本語/Japanese)

本製品は工業用(クラス A)電磁環境適合機器です。販売者あるいは使用者はこの点に注意し、住商業環境以外での使用をお願いいたします。

Handling of our product

(English)

This is a class A product. In a domestic environment this product may cause radio interference in which case the user may be required to take adequate measures.

본 제품의 취급에 대해서

(한국어/Korean)

이 기기는 업무용(A급) 전자파적합기기로서 판매자 또는 사용자는 이 점을 주의하시기 바라며 가정외의 지역에서 사용하는 것을 목적으로 합니다.

Contents

1 Outline of Menu Items	1
2 Screen Operations	11
2.1 Display Unit and Keyboard Unit.....	12
2.2 External Memory Interface.....	15
2.3 Standard Screen.....	17
2.3.1 Displayed Part System.....	20
2.3.2 NC Status.....	21
2.3.3 Operation mode/MDI status.....	22
2.3.4 Operation Status.....	22
2.3.5 Alarms/Warnings.....	23
2.3.6 Operation Messages.....	23
2.3.7 Menus.....	24
2.3.8 Changing the Screen Theme Color.....	25
2.3.9 Screen Transition Diagram.....	26
2.4 Home Screen.....	27
2.4.1 Switching between Standard Screen and Home Screen.....	27
2.4.2 Screen Configuration.....	28
2.4.3 Switching Displayed Part System from the Operation Menu.....	33
2.4.4 Operating the Application.....	33
2.4.5 Displaying the Manuals (M800W Windows-based Display Unit/M80W Windows-based Display Unit).....	35
2.5 19-type Vertical Display Unit and Home Applications.....	40
2.5.1 Home Screen (Machine Status Display).....	41
2.5.2 Keyboard Application.....	43
2.5.3 Operation Panel Application.....	44
2.5.4 Manual Application.....	45
2.5.5 Note Application.....	49
2.6 Setting Data.....	52
2.6.1 Setting Numerals and Alphabetical Characters.....	52
2.6.2 Inputting Operations.....	53
2.7 Guidance Function.....	55
2.7.1 Parameter Guidance.....	55
2.7.2 Alarm Guidance.....	57
2.7.3 G Code Guidance.....	60
2.8 Menu List.....	63
2.9 Touchscreen Functions.....	65
2.9.1 Basic Operation.....	65
2.9.2 Software Keyboard.....	67
2.9.3 Operating the Screen by Touch Gestures.....	72
2.10 Menu Customization Function.....	81
2.11 Changing the Operation Level (Protect Setting Screen).....	83
2.12 Assigning Arbitrary Character String to a User-defined Key.....	84
2.12.1 Format of Configuration File.....	85
2.12.2 Definition Types of User-defined Keys.....	86
2.12.2.1 Type 1.....	86
2.12.2.2 Type 2.....	88
2.12.3 Editing a Configuration File.....	90
2.13 Outputting the Screen Information (Screenshot Capture Function) (Only for Non-Windows-Based Display Unit).....	91
3 Inputting a Machining Program and Defining Variables	93
3.1 Inputting a Machining Program.....	94
3.2 Creating and Editing a Machining Program.....	94
3.3 Registering and Editing the MDI Program.....	105
3.4 Registering and Editing the Fixed Cycle Program.....	107
3.4.1 Fixed Cycle Operation Parameters.....	107
3.4.2 Transmitting and Erasing the Fixed Cycle Program.....	107
3.5 Erasing a File.....	108
3.6 Editing Operations.....	109
3.6.1 Changing the Display.....	109
3.6.2 Displaying an Arbitrary Line.....	112
3.6.3 Rewriting Data.....	112
3.6.4 Inserting Data (Initial Data Overwrite Mode).....	113

3.6.5	Overwriting Data (Initial Data Insertion Mode)	114
3.6.6	Deleting Data	114
3.6.7	Searching for Character Strings	116
3.6.8	Replacing Character Strings	120
3.6.9	Copying and Pasting Data	121
3.6.10	Undoing Program Changes	123
3.6.11	Searching T codes	124
3.7	Program Editing Support Function	125
3.7.1	Displaying Input Mistakes	125
3.7.2	Performing Operation Search at the Cursor Position	130
3.7.3	Adding Sequence No. (N No.) Automatically	131
3.7.4	G Code Guidance	132
3.7.5	Playback Editing	133
3.7.6	Displaying the Finished Shape	137
3.8	Editing a Multi-part System Program	138
3.8.1	Multi-part System Simultaneous Program Editing	138
3.8.2	Special Program Editing Display for Synchronization between Part Systems	146
3.9	Inserting Cycle Interactively	148
3.9.1	Types of Cycle	149
3.9.2	Name of Data	151
3.9.3	Screen Configuration	152
3.9.4	Operation Descriptions	153
3.9.5	Operation Procedure	155
3.9.6	Highlighting the Cycle Program	156
3.10	Defining Variables	157
3.10.1	Common Variables	157
3.10.2	Local Variables	163
4	Checking a Machining Program on Screen	167
4.1	Graphic Check (2D)	168
4.1.1	Checking Continuously	174
4.1.2	Checking One Block at a Time	177
4.1.3	Setting the Coordinate System to Draw	178
4.1.4	Drawing during a Program Check	181
4.1.5	Changing the Display Range	181
4.1.6	Changing the Display Mode	183
4.1.7	Changing the Display Angle	185
4.1.8	Switching the Axis Movement Direction (+, -)	186
4.1.9	Displaying the Machining Program on Checking	187
4.1.10	Switching to Full-screen Display Mode	187
4.1.11	Setting Auto Graphic	188
4.1.12	Availability of Check Mode with Other Functions	190
4.1.13	Handling of Variable Commands, Programmable Parameter Input, and Programmable Compensation Data Input	192
4.1.14	Switching the Draw Path	193
4.1.15	Drawing a Path Corresponding to the Rotary Axis (L System)	194
4.1.16	Setting the Drawing Speed of Program Check	195
4.1.17	Notes for Graphic Check (2D)	196
4.2	Graphic Check (3D) (M System)	201
4.2.1	Switching Check Method	208
4.2.2	Checking Continuously	209
4.2.3	Checking One Block at a Time	211
4.2.4	Checking Multiple Part Systems Simultaneously	212
4.2.5	Canceling the Program Check	213
4.2.6	Enlarging and Reducing the Workpiece Shape	213
4.2.7	Moving the Workpiece Shape	213
4.2.8	Rotating the Workpiece Shape	214
4.2.9	Performing an Interference Check	214
4.2.10	Setting the Workpiece Shape	215
4.2.11	Setting the Tool Shape	221
4.2.12	Setting the Drawing Speed of Program Check	221
4.2.13	Drawing Travel Command of the Rotary Axis (Check Method II)	222
4.2.14	Availability of Check Mode with Other Functions	225
4.2.15	Handling of Variable Commands, Programmable Parameter Input, and Programmable Compensation Data Input	227
4.2.16	Notes for Graphic Check (3D)	228

4.3 Graphic Check (3D) (L System).....	235
4.3.1 Switching Check Method.....	242
4.3.2 Checking Continuously	243
4.3.3 Checking One Block at a Time.....	245
4.3.4 Checking Multiple Part Systems Simultaneously	246
4.3.5 Canceling the Program Check	247
4.3.6 Enlarging and Reducing the Workpiece Shape	247
4.3.7 Moving the Workpiece Shape	247
4.3.8 Rotating the Workpiece Shape	247
4.3.9 Performing an Interference Check	248
4.3.10 Setting the Workpiece Shape.....	249
4.3.11 Setting the Tool Shape.....	253
4.3.12 Checking a Machining Program between Part Systems	253
4.3.13 Setting the Drawing Speed of Program Check	254
4.3.14 Availability of Check Mode with Other Functions	255
4.3.15 Handling of Variable Commands, Programmable Parameter Input, and Programmable Compensation Data Input.....	256
4.3.16 Notes for Graphic Check (3D).....	256
4.4 Checking the Tool Command (T Code List)	262
4.4.1 Searching T List	263
5 Inputting and Outputting a Machining Program	267
5.1 Inputting and Outputting a Program.....	268
5.2 Selecting a Device, Directory and File	274
5.3 Transferring a File.....	279
5.4 Comparing Files (Compare)	282
5.5 Erasing a File.....	283
5.6 Changing a File Name (Rename)	284
5.7 Creating a Directory	285
5.8 Other Functions	286
5.8.1 Merging a File	286
5.8.2 List of File Names	287
5.8.3 Edit Lock B and C	287
5.8.4 Program Display Lock.....	288
5.8.5 Data Protection Keys	289
5.8.6 Leading Zero	290
5.9 The Batch Input/Output the Machining Program of NC Memory	292
5.10 Formatting Memory Card/DS/USB Memory	296
6 Setting a Tool and a Workpiece.....	297
6.1 Setting a Tool.....	298
6.2 Registering a Tool (Tool Registration Screen).....	298
6.2.1 Registering a Tool in the Magazine Pot	301
6.2.2 Setting the PLC Command	301
6.2.3 Setting and Erasing the Tool No. of Spindle/Standby Tools	302
6.2.4 Erasing the Tool Registration Data	302
6.3 Measuring a Tool (Tool Measurement Screen)	303
6.3.1 Tool Measurement (M System).....	303
6.3.2 Tool Measurement (L System).....	308
6.4 Setting Tool Compensation Amount (Tool Offset Screen).....	320
6.4.1 Setting the Tool Compensation Data	327
6.4.2 Switching the Input Method for the Tool Compensation Data	330
6.4.3 Erasing the Tool Compensation Data	331
6.4.4 Copying and Pasting the Tool Compensation Data	332
6.4.5 Undoing Change of Tool Compensation Data	332
6.4.6 Disabling the Setting of Tool Compensation Amount.....	333
6.4.7 Measuring Tool Compensation Amount.....	334
6.4.8 Moving to designated Compensation Number.....	343
6.5 Setting the Tool Management Data (Tool Management Screen)	344
6.5.1 List of Display Items	346
6.5.2 Data Setting Range.....	351
6.5.3 Menu Configuration	356
6.5.4 Registering New Tool Management Data	360
6.5.5 Switching the Item Type of the Tool Management Data Detailed Portion.....	360
6.5.6 Displaying Data by Designating Tool Management Data No.	361
6.5.7 Displaying Data by Designating Tool No.....	362

6.5.8	Sorting the Data by Tool No.	363
6.5.9	Deleting the Tool Management Data	364
6.5.10	Copying and Pasting the Tool Management Data	365
6.5.11	Specifying Display Format and Setting Range of Additional Information	367
6.6	Tool Life Management	368
6.6.1	Tool Life Management (M System)	369
6.6.1.1	Registering Tool Life Management Data on the Group Unit Display Screen	370
6.6.1.2	Operation Descriptions (Tool life management I/III)	376
6.6.1.3	Operation Descriptions (Tool life management II)	376
6.6.1.4	Registering the Tool Life Management Data Groups on the Group List Display Screen (Tool life management I/II)	378
6.6.2	Tool Life Management (L System)	380
6.6.2.1	Registering the Tool Life Management Data (Tool Life Management I)	381
6.6.2.2	Registering Tool Life Management Data on the Group Unit Display Screen (Tool Life Management II)	383
6.6.2.3	Operation Descriptions (Tool life management I)	387
6.6.2.4	Operation Descriptions (Tool life management II)	388
6.6.2.5	Registering the Tool Life Management Data Groups on the Group List Display Screen (Tool Life Management II)	390
6.6.3	Tool Life Management Set Allocation to Part Systems	391
6.7	Setting and Measuring a Workpiece	392
6.7.1	Workpiece Measurement (M System)	392
6.7.1.1	Carrying Out Surface Measurement	396
6.7.1.2	Carrying Out Hole Measurement	397
6.7.1.3	Carrying Out Width Measurement	399
6.7.1.4	Carrying Out Rotation Measurement	401
6.7.1.5	Performing Automatic Recontact When Contacting the Workpiece	404
6.7.2	Workpiece Measurement (L System)	405
6.8	Setting Workpiece Coordinate System Offset	411
6.8.1	Setting the Coordinate System Offset Amount	414
6.8.2	Erasing the Coordinate System Offset Amount	415
6.8.3	Setting the Workpiece Coordinate Origin	415
6.8.4	Changing the Coordinate System Display	416
6.8.5	Changing the Input Menus to Display	416
6.8.6	Compensating the Workpiece Installation Error Data	417
6.8.7	Compensating the Workpiece Position for Rotary Axis	420
6.9	Setting Workpiece Coordinate System Shift	422
6.9.1	Manually Setting the Workpiece Coordinate System Shift Value	426
6.9.2	Automatically Setting the Workpiece Coordinate System Shift Value	429
6.10	Measuring the Workpiece Installation Error Data	431
6.10.1	Screen Configuration	438
6.10.2	Setting the Measurement Condition	439
6.10.3	Performing Workpiece Installation Error Measurement	441
6.10.4	Precautions for Workpiece Installation Error Measurement	442
7	Setting Parameters	445
7.1	Setting User Parameters	446
7.1.1	Selecting the Parameter Number	449
7.1.2	Setting the Parameters	450
7.1.3	Copying and Pasting Parameters	451
7.1.4	Undoing the Parameter Change	452
7.1.5	Parameter Configuration	453
7.1.6	Echoback	453
7.1.7	Ethernet parameter	454
7.1.8	Setting VNC Server Connection Password	454
7.1.9	Precautions	454
7.2	Selecting High-accuracy Control Parameters (Machining Cond I Screen)	455
8	Setting Machine Movable Area	461
8.1	Setting the Stored Stroke Limit	462
8.1.1	Stored Stroke Limit II	463
8.2	Chuck Barrier/Tailstock Barrier (L System)	465

9 Other Setups	471
9.1 Pallet Program Registration.....	472
9.1.1 Standard Pallet Registration	473
9.1.2 Pallet List Screen	475
9.1.3 Pallet Details Screen.....	477
9.2 R-Navi.....	480
9.2.1 Selecting where to Register a Machining Surface (Machining Surface List Screen)	481
9.2.1.1 Selecting Where to Register a Machining Surface	483
9.2.1.2 Changing the Surface Name	483
9.2.1.3 Switching the Workpiece	484
9.2.1.4 Selecting the Basic Coordinate System	484
9.2.1.5 Automatically Registering Top and Side Faces as Machining Surfaces	485
9.2.1.6 Switching the Coordinate System Direction of a Workpiece Graphic.....	487
9.2.2 Registering and Setting the Workpiece (on the Work Setting Screen)	489
9.2.2.1 Registering the Workpiece	491
9.2.2.2 Changing the Workpiece Name	493
9.2.2.3 Changing the Form of the Work	493
9.2.2.4 Changing the Workpiece Size	494
9.2.3 Setting the Details of the Surface (on the Surface Detail Screen)	495
9.2.3.1 Moving the Cursor	498
9.2.3.2 Setting the Surface Coordinate Origin (Feature Coordinate Origin).....	498
9.2.3.3 Specifying the Surface Coordinate Axial Directions	499
9.2.3.4 Checking the Setting Value of Coordinate Axis.....	504
9.2.3.5 Changing the Combination of Axial Direction.....	504
9.2.3.6 Switching the Surface.....	504
9.2.3.7 Rotating the Axial Direction of Coordinate Axis.....	505
9.2.3.8 Default Settings of Designation Method and Axis Combination	506
9.2.4 Surface Selection	507
9.2.4.1 Selecting a Machining Target Surface	509
9.2.4.2 Indexing the Machining Target Surface	510
9.2.4.3 Canceling the Machining Target Surface	511
9.2.4.4 Switching the Machining Target Surface	512
9.2.4.5 Switching the Workpiece	512
9.3 Integrated Time.....	513
9.3.1 Integrated Time Display	513
9.3.2 Setting the Integrated Time.....	514
9.3.3 Setting the Time Display Selection	515
9.4 Counter Setting.....	516
9.5 Origin Set, Origin Cancel	518
9.6 Manual Numerical Value Command	521
9.7 MDI Program Editing	523
9.8 PLC Switch	525
9.8.1 Turning PLC Switches ON/OFF	526
9.9 Thread Recutting Function	527
9.9.1 Storing the Thread Groove Position.....	529
9.9.2 Switching the Stored Thread Groove ON/OFF	530
9.9.3 Erasing the Stored Thread Groove Position	530
9.10 Email Notification Function to Operator	531
9.10.1 Setting for Email Transmission Environment	532
9.10.2 Email Transmission Test.....	536
9.10.3 Description of Email Transmission Function	537
9.10.4 Inputting and Outputting Data	537
10 Machining a Workpiece	539
10.1 Operation Search.....	540
10.1.1 Executing an Operation Search	543
10.1.2 Changing Whether to Show or Hide the Comment Field	544
10.1.3 Changing the Sorting Method	545
10.2 Checking the Movement under Machining (Monitor Screen).....	546
10.2.1 Screen Layout.....	546
10.2.2 Switching the Display Format.....	567
10.2.3 Switching the Counter Types	568
10.2.4 Switching the Spindle No. to be Displayed on Counter.....	573
10.2.5 Operation of 2-part/3-part/4-part System Simultaneous Display.....	573
10.2.6 Counter All-axis Display	575
10.2.7 Modal Display.....	577

10.2.8 Program Tree Display	583
10.2.9 Integrated Time Display	585
10.2.10 Load Meter Display	585
10.2.11 Spindle, Standby Display	587
10.2.12 Tool Center Coordinate Display	589
10.2.13 All Spindles' Rotation Speed Display	591
10.3 Checking the Movement under Machining (Trace Screen)	592
10.3.1 Displaying the Trace	596
10.3.2 Displaying the Machine Position of the Tool Center Point Trace	597
10.3.3 Changing the Display Range	597
10.3.4 Changing the Display Mode	600
10.3.5 Changing the Display Angle	601
10.3.6 Displaying the Machining Program on Checking	602
10.3.7 Switching the Full-screen Display Mode	602
10.3.8 Switching the Axis Movement Direction (+, -)	602
10.3.9 Drawing a Path Corresponding to the Rotary Axis	602
10.3.10 Precautions for Tracing	602
10.4 Restart Search	603
10.4.1 Main Screen	607
10.4.2 Top Search Screen	609
10.4.3 File Setting Screen	610
10.4.4 MSTB History Screen	611
10.4.5 Operation Sequence for Program Restart	612
10.4.6 Executing Restart Search (Restart Type 1)	614
10.4.7 Executing Restart Search (Restart Type 2)	615
10.4.8 Returning to the Restart Position	618
10.4.9 Executing the MSTB Commands	620
10.5 Collation and Stop	621
10.6 Correcting the Machining Program	625
10.6.1 Program Editing	625
10.6.2 Buffer Correction	631
11 Troubleshooting	635
11.1 Confirming the NC Message (Alarm Screen)	636
11.1.1 Alarm History	638
11.2 Checking Machine Status	640
11.2.1 System Configuration Screen	640
11.2.2 Option Display Screen	643
11.2.3 Drive Monitor Screen (Servo Unit)	644
11.2.4 Drive Monitor Screen (Spindle Unit)	649
11.2.5 Drive Monitor Screen (Power Supply Unit)	654
11.2.6 Drive Monitor Screen (Synchronous Error)	656
11.2.7 Clearing the Alarm History on Drive Monitor Screen	657
11.3 Diagnosis Screens	658
11.3.1 Self Diagnosis Screen	658
11.3.2 Servo Diagnosis Screen	663
11.3.3 Collecting the Data on the Diagnosis Data Collection Setting Screen	666
11.4 Advanced Diagnosis	669
11.4.1 Displaying and Setting the PLC Device Data (I/F Diagnosis Screen)	669
11.4.1.1 Displaying the PLC Device Data	671
11.4.1.2 Carrying Out Modal Output	672
11.4.1.3 Carrying Out One-shot Output	673
11.4.2 Writing and Reading the Data Using the NC Data Designation (NC Memory Diagnosis Screen)	674
11.4.3 Collecting the NC Data (Data Sampling Screen)	676
11.5 Safety Observation	677
11.5.1 Safety Observation Screen (Configuration Diagnosis)	677
11.5.2 Safety Observation Screen (Signal Monitor)	679
11.5.3 Safety Observation Screen (Drive Monitor)	681
11.5.4 Safety Observation Screen (Version Display)	684
12 Performing a Backup Operation	685
12.1 Selecting a Device, Directory and File	690
12.2 Transferring a File	699
12.3 Comparing Files (Compare)	703
12.4 Erasing a File	704
12.5 Changing a File Name (Rename)	705











12.6 Creating a Directory	706
12.7 Restrictions	707
12.7.1 Device Definition	707
12.7.2 List Display	707
12.7.3 Program Name	707
12.7.4 ALL.PRM Input	708
12.8 Other Functions	709
12.8.1 Merging a File	709
12.8.2 List of File Names	710
12.8.3 Edit Lock B and C	711
12.8.4 Data Protection Keys	712
12.8.5 The Batch Input/Output the Machining Program of NC Memory	712
12.8.6 Format Memory Card/DS/USB Memory	715
12.9 Performing Batch Backups of NC Memory Data	716
12.9.1 All Backup	719
12.9.2 All Restoration	721
13 Daily Maintenance	723
14 Appendix 1: VNC Server Function	727
14.1 Environment Establishment (Preparation)	728
14.2 Displaying the NC Screen with VNC Client	729
14.2.1 Connecting VNC Client	729
14.2.2 Operating the NC Using the Keyboard	731
14.2.3 Imposing Restrictions to VNC Client Operations	731
14.3 Troubleshooting	732
15 Appendix 2: IP Filter Setting Function	735
15.1 Setting the IP Address Filter	736
15.2 Examples for Using IP Address Filter	737
16 Appendix 3: List of Function Codes	739
17 Appendix 4: RS-232C I/O Device Parameter Setting Examples	741
18 Appendix 5: Other Functions for Reference	743
18.1 F1-digit Feed	744



















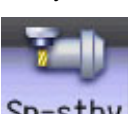

Outline of Menu Items

This chapter explains the outline of the menus for each screen.
Refer to the corresponding section for detailed operation.









Monitor screen (Monitr)



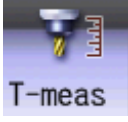





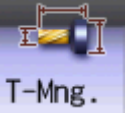

Menus	Details	Reference
 Search	This executes operation search.	10.1 Operation Search
 Reserch	This executes restart search.	10.4 Restart Search
 Edit	This edits the searched machining program.	10.6 Correcting the Machining Program
M system  Trace L system  Trace	This executes graphic trace.	10.3 Checking the Movement under Machining (Trace Screen)
 Check	This checks the program.	4 Checking a Machining Program on Screen
M system  Offset L system  Offset	This displays the tool compensation amount. A value can also be set for the tool compensation amount.	6.4 Setting Tool Compensation Amount (Tool Offset Screen)
 Coord	This displays the workpiece coordinate system offset. A value can also be set for the workpiece coordinate system offset.	6.8 Setting Workpiece Coordinate System Offset
 W-shift	This displays the workpiece coordinate system shift. <Note> ♦This menu is not displayed for M system, or when the parameter "#11056 Workshift invalid" is set to "1".	6.9 Setting Workpiece Coordinate System Shift
 Dsp sw.	This displays the sub-menu to change the display type of the monitor screen.	10.2.2 Switching the Display Format





Menus	Details	Reference
 Modal	This displays the program modal.	10.2.7 Modal Display
 Tree	This displays the program tree.	10.2.8 Program Tree Display
 Time	This displays the date, time and integrated time, etc. The date, time and integrated time, etc., can also be set.	9.3 Integrated Time
 Com var	This displays the common variables. A value can also be set for the common variable.	3.10.1 Common Variables
 Loc var	This displays the local variables.	3.10.2 Local Variables
 P corr	This corrects the buffer.	10.6.2 Buffer Correction
 PLC SW	This turns the PLC switches ON or OFF.	9.8 PLC Switch
 G92 set	This sets and cancels the origin.	9.5 Origin Set, Origin Cancel
 Col stp	This executes collation and stop.	10.5 Collation and Stop
 LdMeter	This displays the spindle load, NC axis load, etc., with a bar graph. The display contents differ depending on MTB specification.	10.2.10 Load Meter Display
M system  Sp-stby L system  Sp-stby	This displays the current spindle tool number and the tool number that is standby to be used next. The display contents differ depending on MTB specification.	10.2.11 Spindle, Standby Display

Menus	Details	Reference
	Displays the tool tip coordinate, handle interruption amount (tool axis movement), and tool tip speed. <Note> ♦This menu is displayed in the following cases: - When any of the additional specifications (tool center point control, tool length compensation along the tool axis, tool handle feed & interruption, workpiece installation error compensation, inclined surface machining command, simple inclined surface machining command, and 3-dimensional tool radius compensation (tool's vertical-direction compensation), 3-dimensional manual feed, or R-Navi) is valid - When the program format switch specification is valid	10.2.12 Tool Center Coordinate Display
	This displays the command rotation speed and actual rotation speed values of all spindles.	10.2.13 All Spindles' Rotation Speed Display
	This selects a machining surface to apply side machining or inclined surface machining to. <Note> ♦This menu is not displayed when the R-Navi additional specification is disabled.	9.2.4 Surface Selection
	This switches the counter display to replace the currently displayed axis.	10.2.4 Switching the Spindle No. to be Displayed on Counter
	This enlarges the counter to display all axes.	10.2.6 Counter All-axis Display
	An arbitrary value can be set in the relative position counter.	9.4 Counter Setting
	This executes a manual numerical value command.	9.6 Manual Numerical Value Command



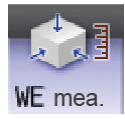

Setup screen (Setup)

Menus	Details	Reference
M system  T-ofs L system  T-ofs	This sets tool compensation amount. Depending on the setting of the parameter "#1046 cmdtyp", there are three types of tool compensation: tool compensation type I/II (M system only), and tool compensation type III. The number of tool compensation sets to be designated or displayed varies depending on the additional specifications.	6.4 Setting Tool Compensation Amount (Tool Offset Screen)
M system  T-meas L system  T-meas	This executes tool measurement. The distance from the basic point to the measurement point is measured by moving the tool to the measurement point manually, and this value can be set as the tool offset amount. <Note> ♦This menu is displayed when the parameter "#8932 Hide measure scrn" is set to "0".	6.3 Measuring a Tool (Tool Measurement Screen)
 T-reg	This registers a tool. A tool No. is assigned to each tool to make the tools installed on the machine recognizable to the NC. The tool No. is registered corresponding to the magazine pot and spindle where that tool is installed, and the standby location.	6.2 Registering a Tool (Tool Registration Screen)
M system  T-life L system  T-life	This manages the tool life data. The life management data such as the tool usage is set and displayed. There are two types of the tool life management method.	6.6 Tool Life Management
 Coord	This sets the workpiece coordinate system offset. The offset value managed by NC can be set and displayed.	6.8 Setting Workpiece Coordinate System Offset
 W-meas	This executes workpiece measurement, it also sets and measures the workpiece coordinate system shift. <Note> ♦This menu appears under any of the following conditions: - The parameter "#8932 Hide measure scrn" is set to "0". - The parameter "#11056 Workshift invalid" is set to "0" for L system.	6.9 Setting Workpiece Coordinate System Shift



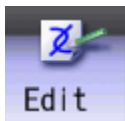



Menus	Details	Reference
M system  T-Mng. L system  T-Mng.	This sets and displays the management data for each tool. These data are relevant to which displayed on the [T-ofs] or [T-life] screen, that can be set the tool information. Thus the mutually-referenced data can be set and displayed on this screen.	6.5 Setting the Tool Management Data (Tool Management Screen)
 MDI	This edits an MDI program. The pop-up window appears to display the MDI program contents by pressing main menu [MDI].	9.7 MDI Program Editing
 Cnt set	This is to set the relative value counter. This displays the pop-up window of the relative position counter to execute the counter setting.	9.4 Counter Setting
 MST	This sets an arbitrary value for S, M, T and B. Manual numerical value command is set and executed by inputting an address key, such as S, M, T and B.	9.6 Manual Numerical Value Command
M system  T-list L system  T-list	This searches the T command in designated machining program (including the subprograms) and lists it in the order of appearance.	4.4 Checking the Tool Command (T Code List)
 APC Pallet	This registers the machining program per each pallet of the automatic pallet changer (hereinafter APC). <Note> ♦This menu is not displayed when the additional specification for pallet program registration is not added.	9.1 Pallet Program Registration
 User	This sets the user parameters. The parameter can be set and displayed by switching types.	7.1 Setting User Parameters
 Storage	This stores the thread groove position to enable re-thread machining. <Note> ♦This menu is not displayed when the additional specification for thread recutting is not added.	9.9 Thread Recutting Function
 Surf	This registers the workpiece and its target surface, on which side surface or inclined surface machining is executed. <Note> ♦This menu is not displayed for L system, or when the R-Navi additional specification is not added.	9.2 R-Navi

Menus	Details	Reference
 MacCond	This sets the high-accuracy parameter which meets the machining purpose or machining process. <Note> ♦This menu is not displayed when the additional specifications related to high-accuracy control are not added.	7.2 Selecting High-accuracy Control Parameters (Machining Cond I Screen)
 Barrier	This sets and displays the chuck barrier and tailstock barrier. <Note> ♦For M system, this menu is not displayed.	8.2 Chuck Barrier/Tailstock Barrier (L System)
 WE mea.	This measures the workpiece installation error and the measurement results are set in the workpiece coordinates system offset. <Note> ♦This menu is not displayed for L system, or when the additional specification for workpiece installation error compensation is not added.	6.10 Measuring the Workpiece Installation Error Data
 E-mail	This sets environment/conditions of email transmission and destination address. <Note> ♦This menu is not displayed when the additional specification of email notification to operator is not added.	9.10 Email Notification Function to Operator

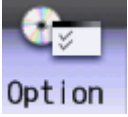

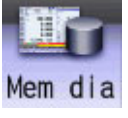
Edit screen

Menus	Details	Reference
 Edit	This edits a machining program.	3 Inputting a Machining Program and Defining Variables
 Check	This checks the program. This function allows you to check the machining program without automatic operations. It can draw machining program movement path (2D), workpiece shape in the cutting process and tool movement (3D), and displays the operation result of NC internal data.	4 Checking a Machining Program on Screen
 NAVI	This allows an operator to interactively set data to create a machining program automatically. The program can be created easily on the interactive pattern input screen. <Note> ♦This menu is not displayed when the parameter "#8996 Simple program ON" is set to "0".	
 I/O	This inputs and outputs the program between the NC internal memory and the external input/output device. <Note> ♦This menu is not displayed when the parameter "#8923 Hide Edit-IO menu" is set to "1".	5 Inputting and Outputting a Machining Program

Diagnose screen (Diagn)

Menus	Details	Reference
 Config	This displays the hardware and software (software No. and version) configurations.	11.2.1 System Configuration Screen
 Option	This displays the details of the additional specifications registered in the NC memory.	11.2.2 Option Display Screen
 I/F dia	This sets and displays input/output signals of the ladder program.	11.4.1 Displaying and Setting the PLC Device Data (I/F Diagnosis Screen)
 Drv mon	This displays drive diagnostic information (servo/spindle/power supply unit).	11.2.3 Drive Monitor Screen (Servo Unit) 11.2.4 Drive Monitor Screen (Spindle Unit) 11.2.5 Drive Monitor Screen (Power Supply Unit) 11.2.6 Drive Monitor Screen (Synchronous Error) 11.2.7 Clearing the Alarm History on Drive Monitor Screen
 Mem dia	This sets and displays NC internal data.	11.4.2 Writing and Reading the Data Using the NC Data Designation (NC Memory Diagnosis Screen)
 Alarm	This displays a list of currently occurring alarms and their messages.	11.1 Confirming the NC Message (Alarm Screen)
 Selfdia	This displays the status of the hardware and operation stop.	11.3.1 Self Diagnosis Screen
 NC Smp	This displays the hardware and operation stop state.	11.4.3 Collecting the NC Data (Data Sampling Screen)
 Safety	This executes the diagnosis related to functional safety. <Note> ♦This menu is displayed when the parameter "#1481 Enable S-safety" (Enable smart safety observation) is set to "1".	11.5 Safety Observation

Maintenance screen (Mainte)

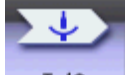
Menus	Details	Reference
 Mainte	This performs NC memory format, absolute position parameter setting and maintenance data backup.	11.3.2 Servo Diagnosis Screen 11.3.3 Collecting the Data on the Diagnosis Data Collection Setting Screen
 Param	This sets and displays user parameters and machine parameters.	7 Setting Parameters
 I/O	This inputs and outputs the various data between the NC memory and the external input/output device.	12 Performing a Backup Operation

Screen Operations

This chapter describes the common functions of the screen.

2.1 Display Unit and Keyboard Unit

Setting display unit consists of the display and keyboard unit. (Except for 19-type display unit.)

Names of parts are as follows.

For details on the 19-type vertical display unit, refer to "2.5 19-type Vertical Display Unit and Home Applications".

<Example for 10.4-type display unit and vertical keyboard>

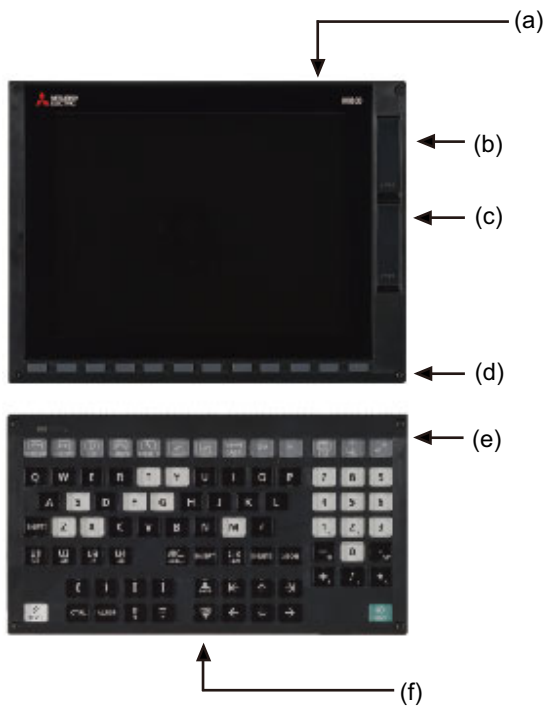



- (a) Display unit
- (b) Front-side USB memory I/F
- (c) Front-side SD card I/F
- (d) Menu keys
- (e) Keyboard unit
- (f) Operation keys

There are other types of keyboard units. Refer to the manual of your machine tool for details.













Note





























- (1) Do not hit the key repeatedly.

The following keys are provided on the menu key.

Key type	Key	Operation
Menu changeover keys	 (left side)	The displayed screen operation menu is switched to the screen selection menu of the current screen group. This is also used to cancel the menu operations of the displayed screen.
	 (right side)	When all of the menus cannot be displayed at once, this displays the menus not currently displayed. The  marks at the bottom of the screen indicate that there are menus not displayed.
Menu keys		This changes the screen and displays the data.

The following keys are provided on the keyboard.

Key type	Key	Operation
Function keys (Function selection key)	 (MONITOR)	This displays the screen related to "operations".
	 (SETUP)	This displays the screen related to "setup".
	 (EDIT)	This displays the screen related to "editing".
	 (DIAGN)	This displays the screen related to "diagnosis".
	 (MAINTE)	This displays the screen related to "maintenance".
Page changeover keys	 Previous page key	When the displayed contents cover several pages, this displays the contents of the previous page. The "▲" mark at the top of the screen indicates that there is a previous page.
	 Next page key	When the displayed contents cover several pages, this displays the contents of the next page. The "▼" mark at the top of the screen indicates that there is a next page.
Previous screen display keys (Part system changeover)	 (BACK) Previous screen display key	This redisplay the previously displayed screen.
	 (\$↔\$) (\$→\$) Part system changeover key	When using a multi-part system NC, this displays the data of the next part system. The screen does not change if it is a part system common screen or when only one part system is used.
Data setting keys	A B C D E F G H I J K L M N O P Q R S T U V W X Y Z 0 1 2 3 4 5 6 7 8 9 + - = / . ; etc.	These keys are pressed to set alphabetic characters, numerals and operation symbols, etc.
Particular keys	? Help key	This displays the operation guidance, parameter guidance and alarm guidance corresponding to the current operation.
	 / 	This varies depending on the MTB specifications.
		
	SFP	
	F0	

Key type	Key	Operation
Data correction keys	 (INSERT) Data insert key	This inputs the data insertion mode. When a data setting key is pressed, a character is inserted in front of the current cursor position. The overwrite mode is entered when the [DELETE], [C.B CAN], [INPUT], cursor or TAB, etc., keys are pressed, or when the screen is changed.
	 (DELETE) Data delete key	This deletes the character just before the cursor position in the data setting area. When editing a program, the character on which the cursor is will be deleted and data after the cursor will move to the left.
	 /   (C.B CAN) Cancel key	This cancels the setting in the data setting area.
Lower-case letter input key	 (LOWER CASE)	This changes the input between upper case and lower case alphabetic characters.
Block end key	 (EOB)	This inputs ";".
Shift key	 (SHIFT)	This validates the setting on the lower line of the data setting key.
Cursor keys	 	This moves the cursor up or down one when setting data in the screen display items.
	 	This moves the cursor one item to the left or right when selecting data in the screen display items.  at cursor left end: Moves to the right end of previous line.  at cursor right end: Moves to left end of next line.
	 	This moves the data input cursor one character to the left or right in the data setting area.
Frame keys	 	This switches the tab.
INPUT key	 (INPUT)	This fixes the data in the data setting area, and writes it to the internal data. The cursor moves to the next position.
RESET key	 (RESET)	This resets the NC.
Menu list key	 (Menu List)	This is function that displays each screen's menu configuration as a list.
Operation keys	 (ALTER)	This is alternate key (Alt key).
	 (CTRL)	This is control key.
	 (SP)	This is space key.
User-defined key	   	Arbitrary character string can be assigned to this key. Up to eight character strings can be registered. For details, refer to "2.12 Assigning Arbitrary Character String to a User-defined Key".

2.2 External Memory Interface

There is an external memory interface on right side of display unit.



Refer to the manual issued by MTB for the installation position of side memory interface unit.

Front-side SD card interface/Front-side USB memory interface

It can insert a SD card or a USB memory.

Following operations are available for the stored data in the SD card or USB memory.

- Data input/output
- Machining program (text file) editing
- Machining program operation
- External search by PLC signal

Precautions

- (1) MITSUBISHI will not provide performance guarantee and maintenance for commercially available SD card or USB memory. In case of using, careful performance check must be required.
Commercially available devices may not be compatible with MITSUBISHI units or suitable FA environment for temperature- or noise-wise.
- (2) When inserting/removing an SD card, turn the MITSUBISHI device's power OFF.
- (3) When Inserting/removing a USB memory just after the device's power is ON, be sure to have enough interval to perform that (about 10 seconds or more).
- (4) Machine vibration may cause the USB memory to fall out depending on environment. Therefore, the operation with the front-side USB memory is performed to handle on your own responsibility.
- (5) Do not pull out the card or turn OFF the power during access to the SD card. Failure to observe this could cause the memory contents to be erased.
In case of emergency, always perform backups by having your important data duplicate, etc. as MITSUBISHI will not guarantee the broken or lost data.
Refer to the manual of your SD card or USB memory for details.
- (6) Do not connect a device other than a USB memory device. (including extension cable and USB hub, etc.)
- (7) Keep the external memory interface cover closed except when in front-side USB memory mode.
- (8) Precautions for use
 - Insert the card in the correct direction.
 - Do not touch the connector area with hands or metal.
 - Do not apply excessive force to the connector area.
 - Do not subject the card to bending or strong impacts.
 - Do not open the cover or disassemble the card.
 - Do not use the card in dusty locations.
- (9) Precautions for storage
 - Do not store the card in locations having a high temperature or humidity.
 - Do not store the card in dusty locations.

2.3 Standard Screen

Note

(1) In this manual, a screen with no size indicated is intended for the 10.4-type display unit.

- 8.4-type/10.4-type

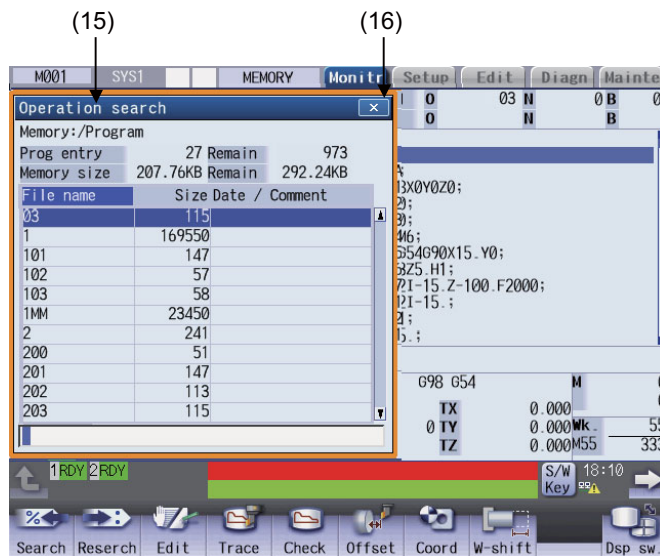
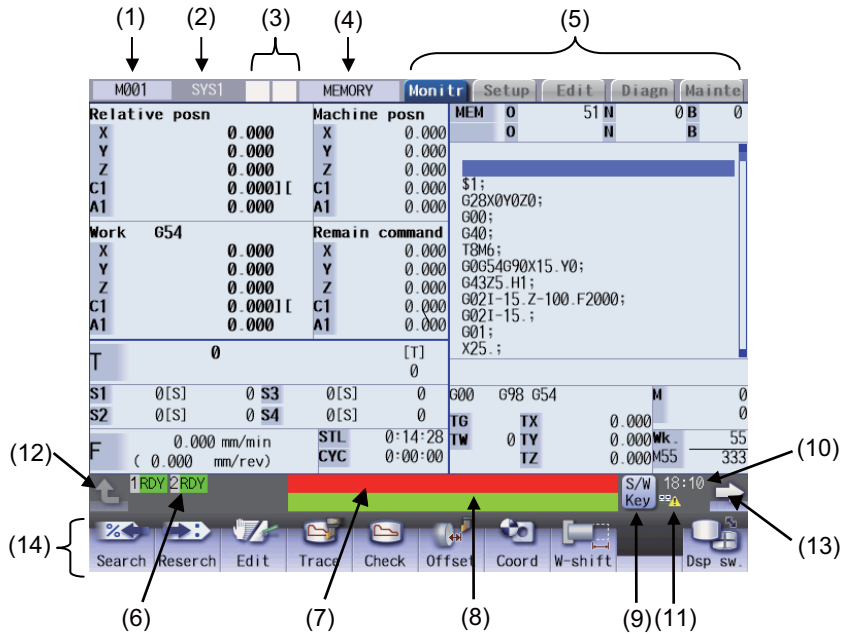

- 15-type/19-type

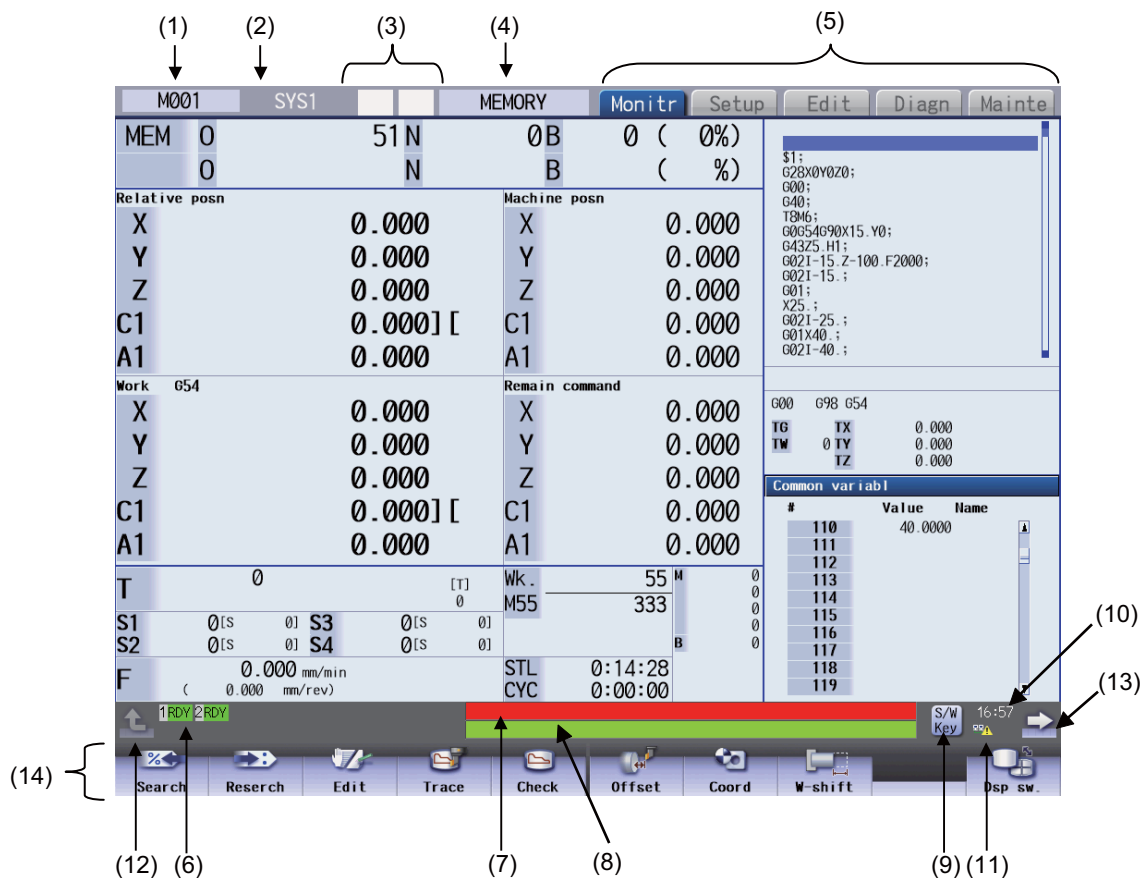

Display items

Display items	Details
(1) Unit name/icon display/ transition button to home screen	The display is changed in the following order of priority: 1. Transition button to home screen When the home screen display is valid by the parameter "#11080 HomeScreen display", the transition button to home screen is displayed. When the home screen display is invalid, either icon display or unit name is displayed. 2. Icon display When there is an icon prepared by MTB, the icon is displayed. When there is no icon prepared, the unit name is displayed. 3. Unit name The currently displayed unit name (name set in the parameter "#1135 unt_nm") is displayed. When the unit name is not set, it is not displayed.
(2) Part system name	When you use the multi-part system, the name of currently displayed part system (name set in the parameter "#1169 part system name", or name set in the parameter "#12059 SBS_name" for operating as the sub part system) is displayed. The part system name is not displayed for the 1-part system. When the values are not set in the parameter, "\$ + (part system number)" is displayed. (Example) \$2 for the 2nd part system. When the values are not set in the parameter for the name of sub part system, "SUB + (part system number)" is displayed. (Example) SUB2 for the 2nd part system.
(3) NC Status	The current NC status is displayed. When the status is multiple, the high-priority contents are displayed.
(4) Operation mode/MDI status	The displayed part system's operation status is displayed. The MDI status is also displayed when the MDI operation mode is selected.

Display items	Details
(5) Screen group	The currently selected screen group is displayed.
(6) Operation status	The NC operation status is displayed.
(7) Alarm message	The highest-priority message among the currently occurring alarms or warnings is displayed.
(8) Operation message	The operation message is displayed.
(9) S/W Key button	When the button is touched, the software keyboard is displayed. The [S/W key] button is not displayed when the parameter "#11010 Software keyboard" is set to "0". However, when the NC keyboard is not mounted, the [S/W key] button is displayed regardless of the parameter setting.
(10) Time	The current time is displayed. (hour:minute)
(11) Host connected status	The icon is displayed under the following conditions. •When the parameter "#8931 Display/Set limit" is set to "0" or "1", and the other host computer or display unit is connected. •When the parameter "#19701 Restrain VNCserver" is set to "1" or "2", and the VNC client is connected. (*1)
(12) Menu return button	The displayed screen operation menu is switched to the screen selection menu of the current screen group. This is also used to cancel the menu operations of the displayed screen.
(13) Menu change button	When all menus cannot be displayed at a time, the menus other than currently displayed menus are displayed.
(14) Menus	This is used to switch the screen, select the screen specific operation, etc.
(15) Window name	Then name of currently displayed window is displayed.
(16) Close button	When the button is touched, the window is closed.

(*1) For details on the VNC server, refer to "14 Appendix 1: VNC Server Function".

2.3.1 Displayed Part System

Changing the part system with key

Press  key to change the displayed part system.

The displayed part system No. is counted up by one each time the key is pressed. If the displayed part system No. exceeds the parameter "#11055 Disp. sysno", the displayed part system No. returns to "1".

Changing the part system with a touchscreen

Displayed part system will change when the part system name on the touchscreen is pressed. The displayed part system No. is counted up by one each time the key is pressed. If the displayed part system No. exceeds the parameter "#11055 Disp. sysno", the displayed part system No. returns to "1".

Restrictions when changing the displayed part system

The operation to change the displayed part system by the  key or touchscreen is restricted by the setting of parameter "#11035 Sys. change limit".

Setting the color of displayed part system

The color combination for the top left of the screen and the window title can be changed with the setting of parameters "#8942 \$1 color" to "#8945 \$4 color", "#8962 \$5 color" to "#8965 \$8 color". Each part system can have a unique color combination which makes easy to understand the displayed part system.

When the part system is changed, the color of the upper left of the screen changes according to the setting with each parameter. A color set with "#8942 \$1 color" will be displayed for the 1st part system.

When the color of displayed part system is changed, the display of part system name changes to the button image.

[Setting example] When "1" is set to the parameter "#8942 \$1 color", "2" is set to the parameter "#8943 \$2 color", and "1" is set to the parameter "#11060 Screen theme color".

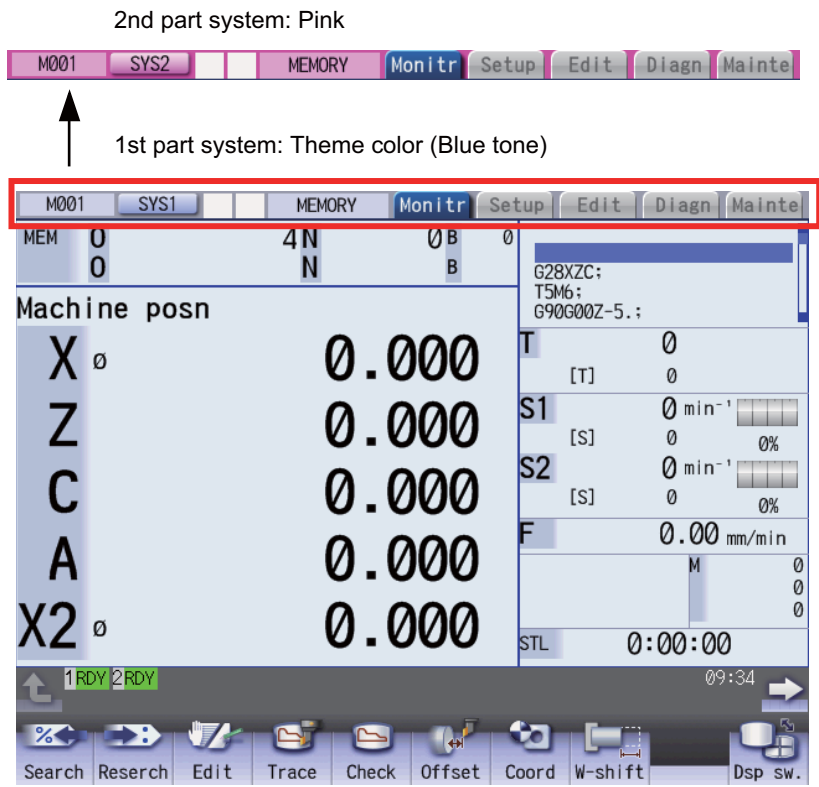

Note

(1) When "1" is set, the color is changed depending on the setting of the parameter "#11060 Screen theme color".

Displaying the sub part system name

When the part system operates, which is set to sub part system with the parameter "#12049 SBS_no", the sub part system name can be displayed as the part system name. The name can be set with parameter "#12059 SBS_name".

Display area for the part system names shown in the following figures can switch main/sub part system display according to NC operation status.

[1-part system display]

[2-part system display]

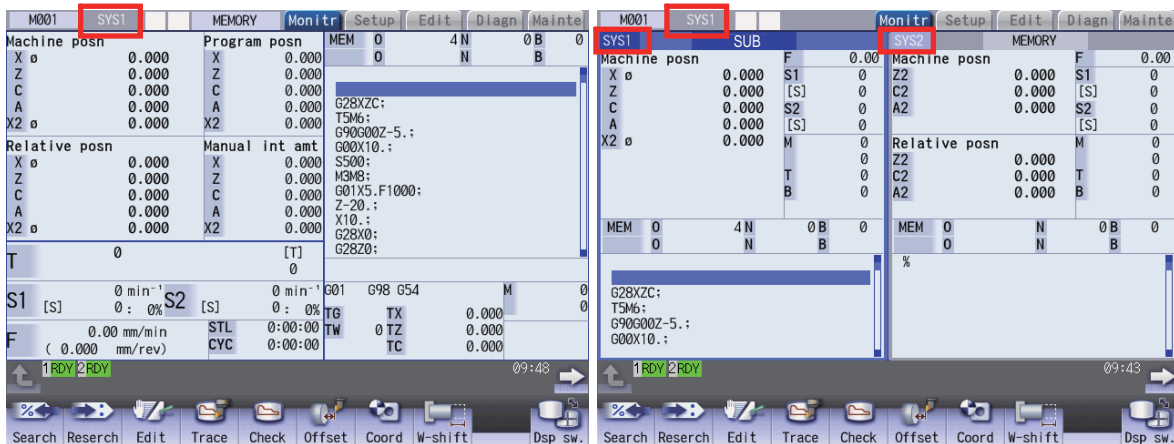

2.3.2 NC Status

The display area for NC status indicates current NC operation status. (nothing is displayed in normal condition.)

When the NC operates with three or more status, the higher-priority two status are displayed. (The items in the following table are listed in order of priority.)

While any status is being displayed, this indicator flashes at intervals of approximately 1 second.

Display position	Display items	Meaning
Left side	PR	The parameter has changed, and it requires turning the power ON again. The parameter will be validated after turning the power ON.
Right side	AT	Indicates when auto tuning is valid. In this case, the automatic start is disabled.
	HC	Indicates when the high cycle sampling is valid.
	RN	Indicates when selecting machining surface.
	BT	Indicates when backlash auto adjustment is ON.
	EM	Indicates when performing workpiece installation error measurement or rotation center error measurement.

2.3.3 Operation mode/MDI status

The displayed part system operation mode and MDI status are displayed.

When the operation mode or MDI status is changed, the display changes as follows.

Display	Details	Details
MEMORY	Memory operation	Automatic operation is based on programs stored in the memory.
TAPE	Tape operation	Automatic operation is based on tape command (RS232C input) programs stored in NC tape.
MDI NON	No MDI setting	Automatic operation is performed with the program set in the MDI screen.
MDI SET	MDI setting completed	
MDI RUN	MDI running	
JOG	Jog	The jog feed mode enables the axis to be moved by hand consecutively at the feed rate set by using the MANUAL FEED RATE switch.
HANDLE	Manual handle	The handle feed mode enables the axis to be moved by turning the manual handle. The travel distance per graduation of the handle depends on how the "HANDLE/INCREMENTAL MAGNIFICATION" switch is set.
STEP	Step	The step feed mode enables the axis to be moved by hand at feed rate when the "FEED AXIS SELECT" switch is ON. The travel distance per graduation of the handle depends on how the "HANDLE/INCREMENTAL MAGNIFICATION" switch is set.
MANUAL	Manual arbitrary feed	This mode enables to move manually with arbitrary amount or arbitrary positioning position.
ZERO-RTN	Reference position return	This mode enables a controlled axis to be returned manually to the defined position unique to the machine (reference position).
INIT-SET	Automatic dog-less reference position return	This mode enables this mode to manually push against the machine end stopper and carry out zero point return.
RAPID	Rapid traverse	The rapid traverse feed mode enables the machine to be moved consecutively at rapid traverse rate manually.
JOG+HND	Jog + Handle	This is the jog and handle synchronous feed mode.
RAP+HND	Rapid traverse + Handle	The rapid traverse and handle can be used simultaneously.
NO MODE	No operation mode	The operation mode is not selected.

2.3.4 Operation Status

The operation status displays the currently selected NC operation status for each part system. (The maximum number of the part system which can be displayed.)

The inverted number expressing the part system No. is not displayed for 1-part system.

Symbol	Details	Character color	Background color
EMG	In emergency stop	White	Red
RST	Resetting NC	White	Dark gray
BST	In block stop	White	Dark gray
HLD	Operation halted	White	Dark gray
SYN	Synchronizing	White	Dark gray
CRS	Cross conversion waiting	White	Dark gray
AUT	In automatic operation	White	Dark gray
RDY	Operation completed state	Black	Green

2.3.5 Alarms/Warnings

When an alarm or warning occurs, the alarm No. and alarm message character string are displayed.

(Example) Warning message display

SYS2 M01 No operation mode

Type	Details	Character color	Background color
NC alarm message	The operation alarm, program error, MCP alarm, servo alarm, or system alarm which is currently occurred is displayed.	White	Red
NC warning message		Black	Yellow
PLC alarm message	The message such as the machine error contents is displayed using user PLC.	White	Red
PLC operator message	The operator information message is displayed using user PLC.	Black	Yellow
NC alarm message at the background check	The message is displayed when a program error occurs during the check, or when the macro alarm message (message display by #3000 variable command) is displayed.	White	Orange

The display format of PLC alarms and operator messages can be selected by the parameter "#11021 PLC mesg disp type" (Format of PLC alarm and operator message).

0: Display up to the first 40 characters.

1: If text is longer than 40 characters, divide it into two and display separately. (Classification No. is displayed together)

2.3.6 Operation Messages

(Example)

Search completed

Type	Details	Character color	Background color
Operation messages	This displays the messages for operation.	Black	Yellowish green

The operation message can be reset by pressing any key.

2.3.7 Menu

The menu can be used to select screens and to select functions or setting items. Up to ten menus can be displayed at once.

[When using the keyboard for operations]

To select the menu, use the menu key below the menu display.

To change the menu, use the menu changeover key.



: The operation menu is canceled.

The screen selection menu for the currently displayed screen group appears.



: When there are more than 11 menus, this key displays the remaining menus.

[When using the touchscreen for operations]

To select a menu, touch the desired menu.

To change a menu, touch  (menu changeover key).



: The operation menu is canceled.

The screen selection menu for the currently displayed screen group appears.



: When there are more than 11 menus, this key displays the remaining menus.

If you flick the menu rightward (quickly run your fingertip rightward along the screen), the menu slides, and changes to the next menu.

Note

(1) The 8.4-type display unit does not support touchscreen.

2.3.8 Changing the Screen Theme Color

The theme color (display color) of the entire screen can be changed with the setting of the parameter "#11060 Screen theme color".

[Parameter "#11060 Screen theme color" is set to "0" (standard color (gray tone))]

<Example of monitor screen>

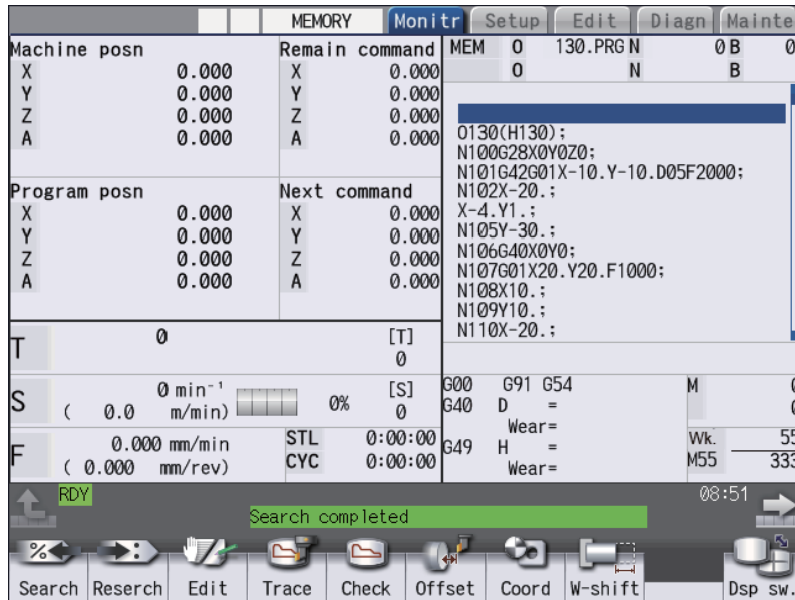

[Parameter "#11060 Screen theme color" is set to "1" (blue tone)]

<Example of monitor screen>

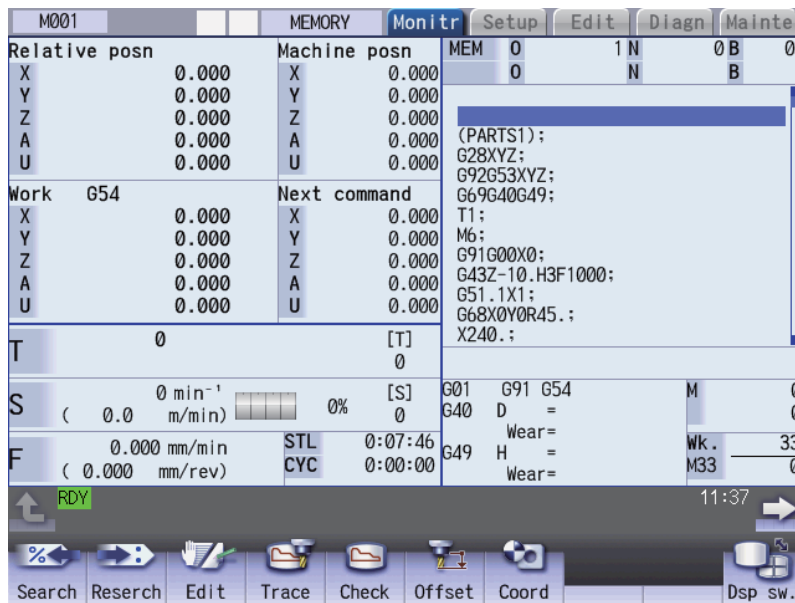

2.3.9 Screen Transition Diagram

The screen is configured of operation groups. The screen selection can be done by switching the tab on the top of the screen or pressing the function key such as [MONITOR] and [SETUP].

Note

- (1) The display contents differ depending on MTB settings.
- (2) You can freely relocate the main menus of the monitor (Monitr), setup (Setup) and edit (Edit) screens. For details, refer to "2.10 Menu Customization Function".

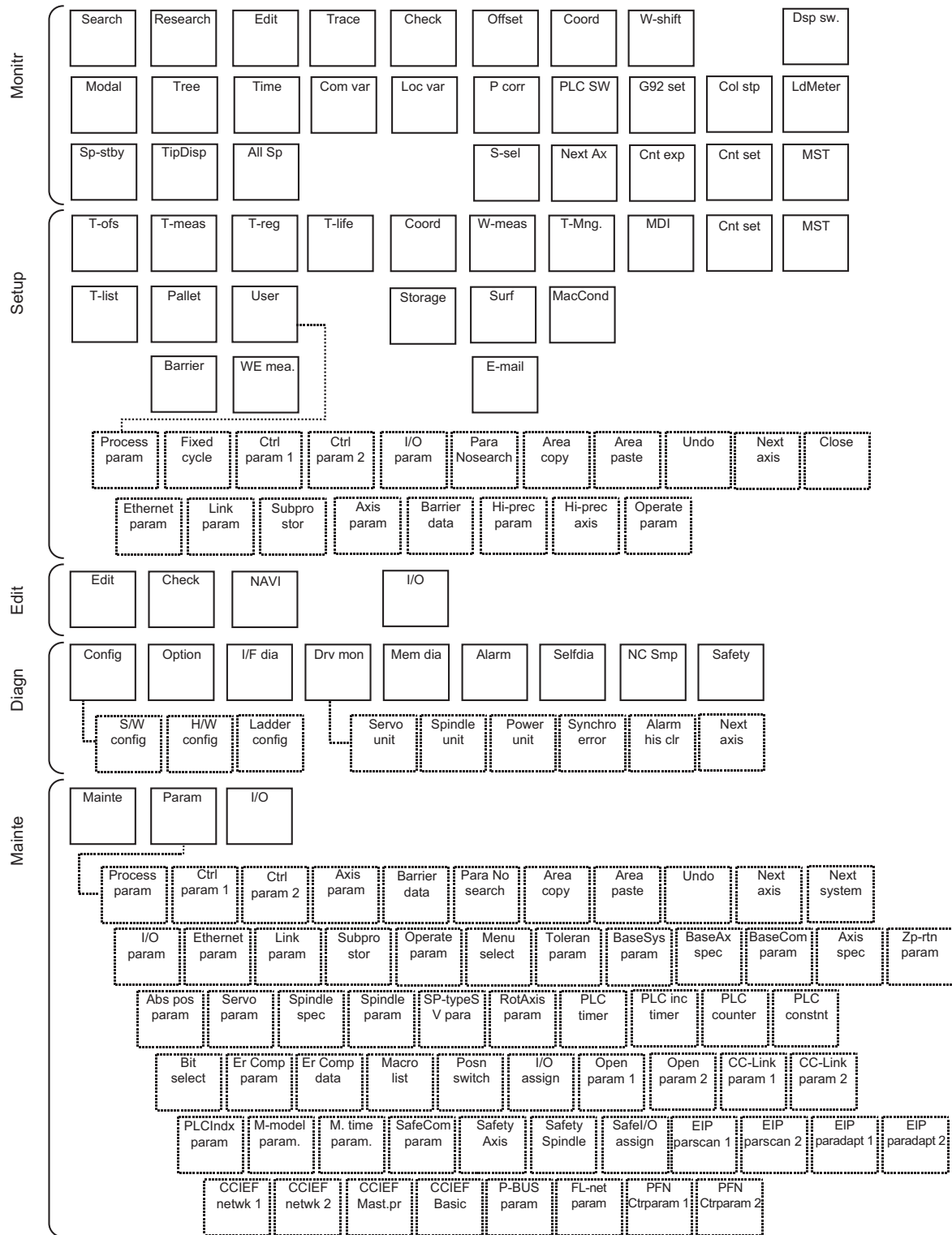

2.4 Home Screen

On the home screen, the machine state (spindle load, linear axis/rotary axis position, etc.) can be displayed and monitored. Also, each application can be called by pressing the application button on the home screen. Registered applications differ depending on MTB.

The home screen display can be selected from the three options (Not display/Display (displayed at the power ON)/Display (not displayed at the power ON)) using the parameter "#11080 HomeScreen display".

2.4.1 Switching between Standard Screen and Home Screen

You can switch between the standard screen and home screen with the switch button on the upper left of the screen.

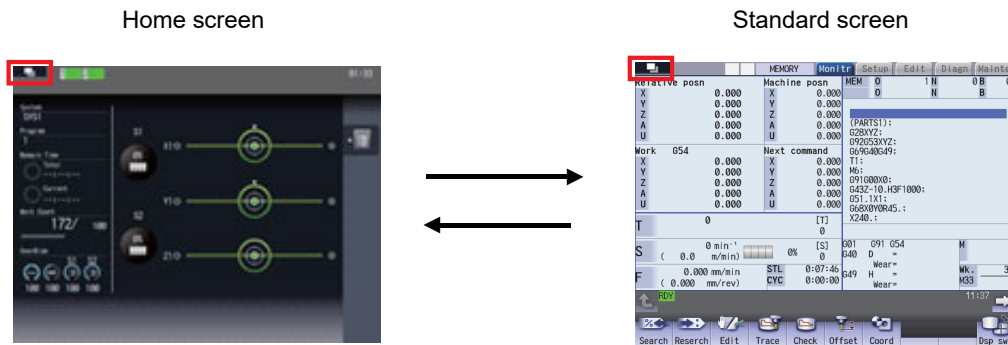

The window display key () performs the same function.

The screen can be changed to the specified screen directly by pressing the function key such as MONITOR or SETUP.

Note

- (1) When you move to the home screen with any window, including the operation search window, open, the window is closed. After you return to the standard screen, the window remains closed.
- (2) The menu list or guidance does not appear while the home screen is displayed.
- (3) When you move to the home screen with the software keyboard displayed, the keyboard is closed.

<For 19-type vertical display unit>

Home application screen is displayed on the bottom of the standard screen. For details, refer to "2.5 19-type Vertical Display Unit and Home Applications".



2.4.2 Screen Configuration

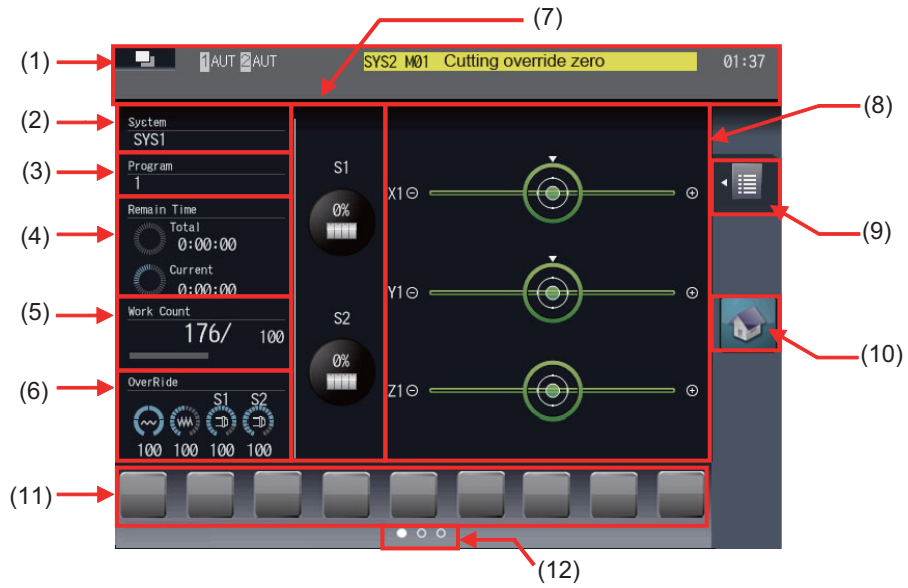

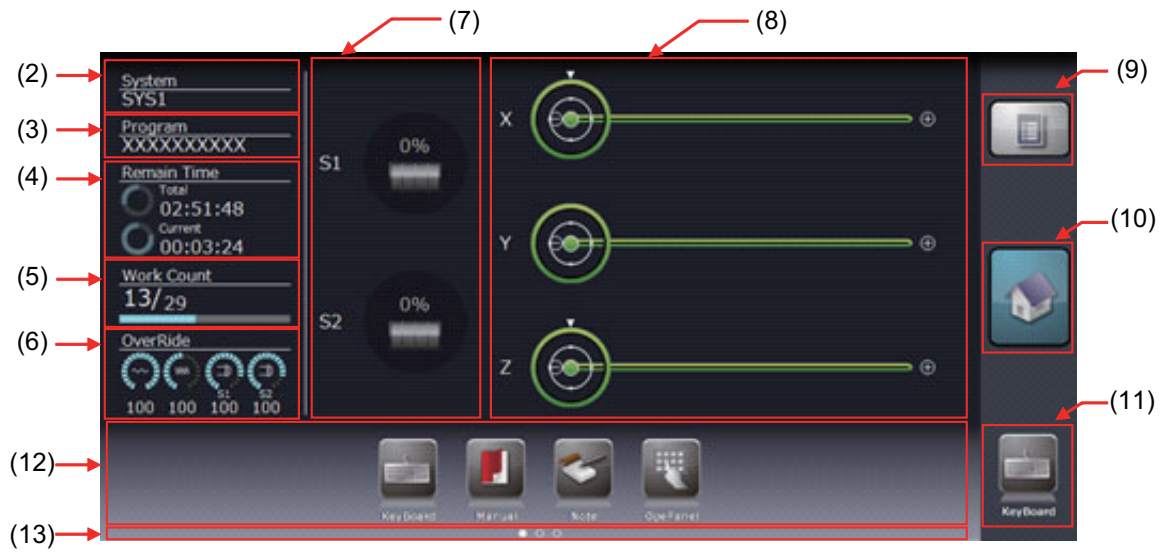

<For 19-type vertical display unit>

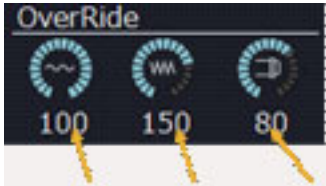

Display items

Display items	Details
(1) Fixed display part (*1)	<p>The following items are displayed.</p> <ul style="list-style-type: none"> •Standard screen switch button When you touch the button, the screen is changed to the previously displayed standard screen. The window display key () performs the same function. •Operation status The NC operation status is displayed. •Alarm messages Currently occurring alarm or warning is displayed. For details, refer to "2.3.5 Alarms/Warnings". •Operation messages •Time (h:m)
(2) Part system name	<p>When you use the multi-part system, the name of currently displayed part system (name set in the parameter "#1169 part system name", or name set in the parameter "#12059 SBS_name" for operating as the sub part system) is displayed.</p> <p>The part system name is not displayed for the 1-part system.</p> <p>When the values are not set in the parameter, "\$ + (part system number)" is displayed. (Example) \$2 for the 2nd part system</p> <p>When the values are not set in the parameter for the name of sub part system, "SUB + (part system number)" is displayed. (Example) SUB2 for the 2nd part system</p> <p><For 19-type vertical display unit></p> <p>Displays the name of part system which is selected in the home application when the name of each part system (the parameter "#1169 part system name") has been set.</p> <p>When the values are not set in the parameter, "SYS + (part system number)" is displayed. (Example) SYS2 for 2nd part system</p>
(3) Machining program	<p>Displays the name of machining program being in the operation search.</p> <p>The name of main program is displayed when the main program is being executed, and the name of sub program is displayed when the sub program is being executed.</p> <p>If the program name is 14 characters or longer, first to 13th characters are displayed.</p>

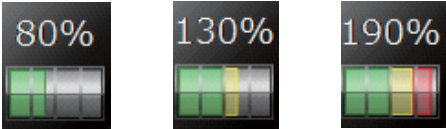
Display items	Details
<p>(4) Remaining machining time</p>	<p>Displays the remaining machining time and reference information of progress rate based on the time from the cycle start to the M command specified with the parameter "#8001 WRK COUNT M" or from the cycle start to M02/M30 command, that is memorized as the machining time per one machining.</p> <p>To display the total time, the workpiece machining count (parameters "#8001" to "#8003") must be specified.</p> <p><Note></p> <ul style="list-style-type: none"> •Time of one machining program which is most recently executed is memorized as the machining time. •If the target program has never been executed after the operation search, the remaining machining time and remaining machining rate are not displayed, but "--:--:--" is displayed. •When the operation search or restart search is executed, the remaining machining time and remaining machining rate are not displayed, but "--:--:--" is displayed. •When the restart search or sequence No. search is executed, the time from the search point is memorized as the machining time. •When reset is performed during the machining, the display returns to the previous state before the machining. When re-machining is performed after the reset, the time from the beginning of re-machining is memorized as the machining time. •When the integrated time is set with variables during the machining, the memorized machining time may not be displayed properly.
	<p>Total</p> <p>Displays the remaining time and progress rate of the machining for all workpieces.</p> <p><Display example></p> <p>Progress rate of the machining = 25% and the remaining machining time = 12 hours 34 minutes 56 seconds</p>  <p>Progress rate of machining Remaining machining time</p>
	<p>Current</p> <p>Displays the remaining time and progress rate of the machining of a workpiece.</p>
<p>(5) Work count</p>	<p>Displays the number of machining times at present (number of machined workpieces/total number of workpieces to be machined) and the proportion.</p> <p>The display depends on the number of workpiece machining that has been set with the parameters "#8001 to #8003".</p> <p>However, when the parameter "#8001 WRK COUNT M" is set to "0", M command is not counted and the work count is not displayed.</p>
<p>(6) Override</p>	<p>Displays the rapid traverse override (%), cutting feed override (%) and spindle override (%).</p> <p>The rapid traverse override is displayed in the range of 0 to 100%, the spindle override is displayed in the range of 0 to 120%, and the cutting feed override is displayed in the range of 0 to 200%.</p> <p><Display example></p> <p>Rapid traverse override 100%, cutting feed override 150%, and spindle override 80%</p>  <p>Rapid traverse Cutting feed Spindle</p>

Display items	Details
(7) Spindle	<p>Displays the spindle load rate (%) with the graph and numeric. Up to two spindles can be displayed per part system. The displayed color of graph varies depending on the spindle load condition. The thresholds of the displayed color (caution/warning) are made in accordance with the parameters (#3192 to #3194). <Display example></p> <p>(Normal: Green) (Caution: Yellow) (Warning: Red)</p> 
(8) Machining axis	<p>Displays the position and load condition (load) of linear axes and the position of rotary axes by animation. Up to three linear or rotary axes can be displayed per part system. Refer to the explanation in next section for details.</p>
(9) Operation menu button	<p>Displays the operation menu for each screen. Home screen: Operation menu to switch the displayed part system Each application: Operation menu for each application (Refer to the specifications issued by MTB for details.)</p> <p>Touch the operation menu button to display/perform the menu. The same operation can be performed with the following keys:</p> <p>Show/hide the operation menu: menu list key () Select/move the menu: cursor keys Determine the menu: [INPUT] key</p>
(10) Home button	Returns to the home screen.
(11) Shortcut button (*2)	<p>This is the application button to switch to the application set by MTB and always displayed on any screen. Two applications can be registered on the shortcut button, and first registered application is usually displayed on the shortcut button. The second registered application is displayed on the shortcut button during the activation of the first registered application.</p>
(12) Application button	<p>Switches to each registered application. Application buttons can be deleted.</p>
(13) Page position	Displays the page position of application buttons.

(*1) This is not displayed on the 19-type vertical display unit.

(*2) This is displayed only on the 19-type vertical display unit.

Machining axes display

The position and load condition of linear axes and the position of rotary axes are displayed by animation.

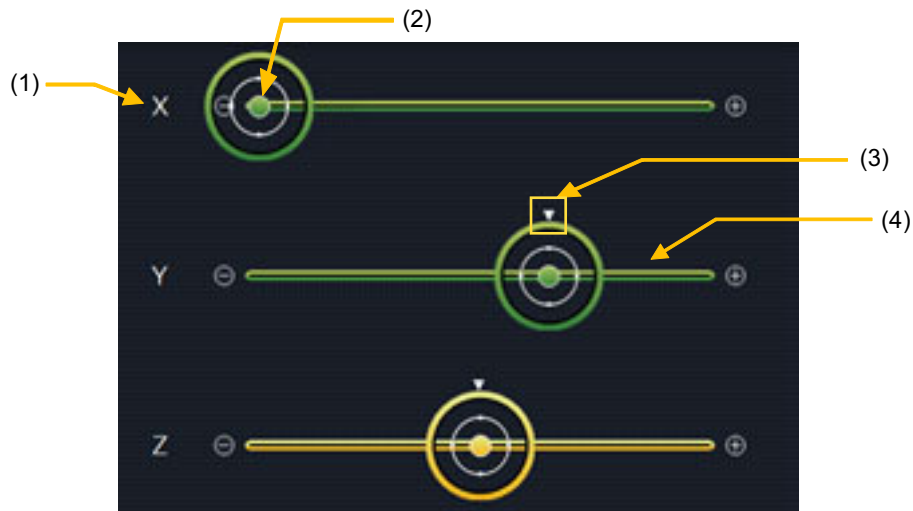

Display items	Details
(1) Name of linear axis	Displays the specified linear axis name which has been set with "#1022 axname2". Only linear axis name is displayed, but the rotary axis name is not displayed.
(2) Linear axis position display	<p>Indicates the linear axis position (disk-shaped figure) by animation. When the axis moves, the disk-shaped figure shifts right and left in accordance with the machine position.</p> <p>The range of coordinate position is determined by the parameters "#2013 OT-" and "#2014 OT+".</p> <p>If the parameters are not set, the operation is performed in the range of -1000.000 to 1000.000.</p> <p><Display example> OT- = -40.000, OT+ = 300.000, and Machine position = 130.000</p>
(3) Rotary axis position display	<p>Indicates the rotary axis position (triangle mark on the disk-shaped figure) by animation.</p> <p>The triangle mark moves to upper side of the disk-shaped figure for 0 degree and moves to lower side of the disk-shaped figure for 180 degree.</p>
(4) Linear axis load condition display	<p>The displayed color of the bar changes depending on the linear axis load condition (load value).</p> <p>The bar is colored with green for normal state, yellow for caution and red for warning.</p> <p>The thresholds of the displayed color (caution/warning) are made in accordance with the parameters "#2643 LdMeter thresholdY" and "#2644 LdMeter thresholdR".</p>

2.4.3 Switching Displayed Part System from the Operation Menu

When you touch the operation menu [System change] and select the part system (SYS1, etc.) that appears at the touch, the display switches to the selected part system.

(Example: Switch to 2nd part system)

(1) Touch the operation menu button.



The operation menu is displayed.

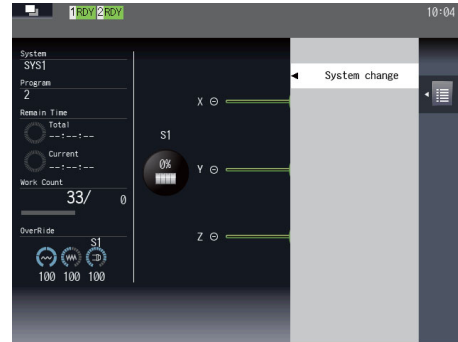

(2) Touch the menu [System change].



Names of selectable part systems are displayed. Currently selected part system is highlighted.

(3) Touch [SYS2].



The operation menu is closed, and the displayed part system is changed to the 2nd part system.

2.4.4 Operating the Application

To move to the application screen, touch the application button on the bottom of the screen. The same operation can be performed by touching the 1st to the 9th menu keys from the left.

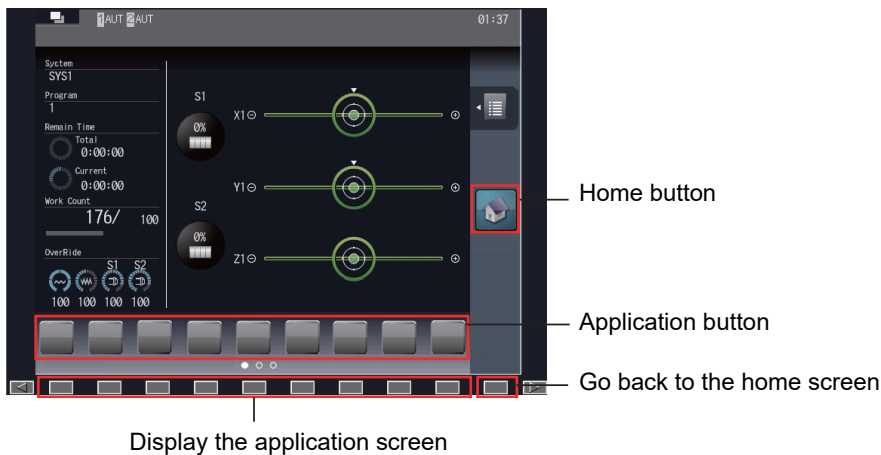



Touch the home button to go back to the home screen.

The same operation can be performed by touching the 10th menu key from the left.





For a full-screen application, however, follow the operation specifications of each application.

Operating the application menus





The operation for each application can be selected by touching the operation menu button () or pressing the menu list key () .

However, as some applications are displayed in full-screen mode, the operation menu button may not be displayed.

■ Operating with the operation menu button

- (1) Touch the  button.  The main menu is displayed.
- (2) Select the main menu.  The sub-menu is displayed on the left of the main menu.
- (3) Touch the sub-menu to be executed.  The menu disappears and the display goes back to the application screen. On the application screen, the selected sub-menu is executed.

■ Operating with the menu list keys

- (1) Press the  key.  The main menu is displayed.
- (2) Use the cursor key [↑] or [↓] to select the main menu.
- (3) Press the cursor key [←].  The sub-menu is displayed on the left of the main menu.
- (4) Use the cursor key [↑] or [↓] to select the sub-menu to be executed.
- (5) Press the [INPUT] key.  The menu disappears and the display goes back to the application screen. On the application screen, the selected sub-menu is executed.

■ Note

- (1) If you touch any other part than the operation menus while they are being displayed, the menus are closed.

2.4.5 Displaying the Manuals (M800W Windows-based Display Unit/M80W Windows-based Display Unit)

To display each manual on the screen, press the manual button assigned to an application button. Application buttons are assigned to 1st to 9th menu keys from the left. The same operation can be performed by pressing the menu key which the manual button is assigned to. The displayed manuals differ depending on MTB.

Displaying the selected manual

- (1) Touch the manual button.

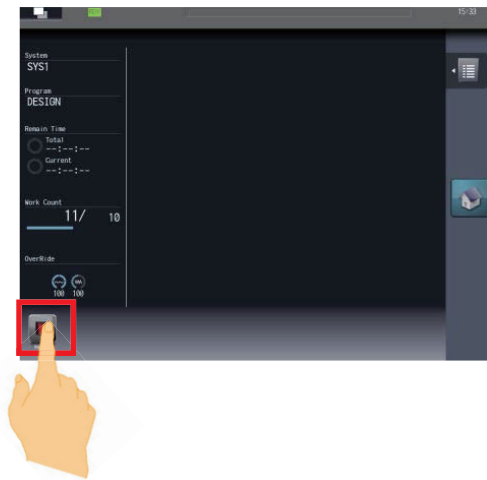

➔ The manual selection screen is displayed. Manuals which can be displayed are shown in the list. The cursor is displayed at the manual button on the top left.

- (2) Touch the manual to be displayed.

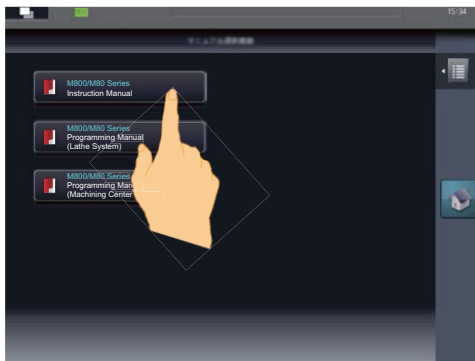

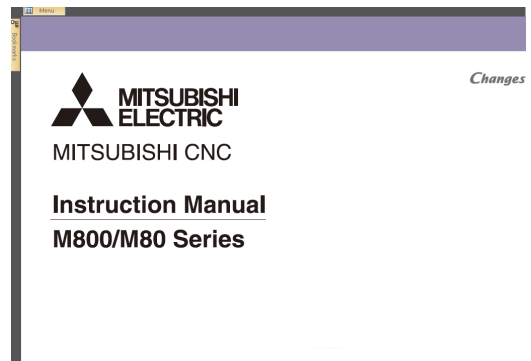

➔ The selected manual is displayed.



When you operate with keys, move the cursor with [↑], [↓], [←] or [→] key and determine with the [INPUT] key to display the selected manual.

Note

- (1) When you move to another screen by the function keys, window display key () or direct screen selection while the manual is displayed, the designated screen is displayed after the displayed manual is closed.
- (2) When you press the window display key () after the display is moved from the manual selection screen or manual display screen to the standard screen, the home screen is displayed.

Operation button on the manual screen

■ Normal display



Touch the [Menu] tab to switch to the ribbon display. The ribbon displays the operation buttons such as page switching, enlarging/reducing, rotation and search.

Touch the [Bookmark] tab to display the contents of the manual.

■ Ribbon display (View tab)

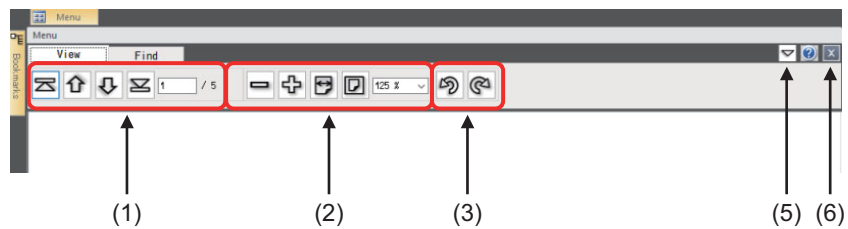















■ Ribbon display (Find tab)





■ Bookmark display



Display items	Details
(1) Page jump group	<p>This displays the operation buttons related to the displayed page or page jump.</p> <p> : This displays the first page.</p> <p> : This displays the previous page.</p> <p> : This displays the next page.</p> <p> : This displays the last page.</p> <p><input type="text" value="1"/> / 5 : Page number input area</p> <p>This displays "the current page number/the total number of pages" of the manual.</p>
(2) Display magnification group	<p>This displays the operation buttons related to the display magnification.</p> <p> : This reduces the display.</p> <p> : This enlarges the display.</p> <p> : This displays the manual based on the page width.</p> <p> : This displays the whole page of the manual.</p> <p><input type="text" value="125 %"/> : This displays the magnification. You can select the display magnification from the drop-down list.</p>
(3) Rotation group	<p>This displays the operation buttons related to the rotation.</p> <p> : This rotates the page 90 degrees to the left.</p> <p> : This rotates the page 90 degrees to the right.</p>
(4) Search group	<p>This displays the operation buttons related to the search group.</p> <p> <input type="text"/> : Search character(s) input area</p> <p> : This searches for the previous item.</p> <p> : This searches for the next item.</p> <p>Search option</p> <p>You can search with the following conditions by checking the box:</p> <p>Whole Words Only: This searches for an exact-match of the given string.</p> <p>Case Sensitive: This searches for the given string distinguishing upper- and lower-case letters.</p>
(5) Ribbon minimize/expand button	<p>This minimizes the ribbon display to return to the normal display.</p>
(6) Close button	<p>This closes the manual display screen to return to the manual selection screen.</p> <p>You can also close the manual by pressing the menu changeover key ().</p>
(7) Bookmark	<p>This displays the bookmarks of the manual being displayed.</p> <p>Select an item from the contents to move to the corresponding page.</p>

Enlarging/reducing the display

To enlarge/reduce the display, use the following methods:

- Pinch in to reduce and pinch out to enlarge on the manual. (*1)
- Touch the [Menu] tab to operate the buttons of the magnification display group in the ribbon display.
 - Touch  /  button.
 - Select the magnification from the drop-down list of the magnification display.
- Press the [+]/[-] key.

(*1) Pinch in: A gesture to pinch a target between the thumb and index finger on the screen

Pinch out: A gesture to spread the thumb and index finger on the screen

Displaying the whole page

When you touch the [Menu] tab and then  in the ribbon display, the height of a single page of the manual is displayed with the size which fits the window.

Touch  to undo.

Moving between pages

To move between pages, use the following methods:

■ Moving to the next page

- Drag or flick upwards on the manual. (*1)
- Drag the vertical scroll bar on the right of the screen downwards.
- Press the cursor key [↓] or the next page key ().

■ Moving to the previous page

- Drag or flick downwards on the manual. (*1)
- Drag the vertical scroll bar on the right of the screen upwards.
- Press the cursor key [↑] or the previous page key ().



■ Moving to the designated page

Touch the [Menu] tab, input the intended page number in the page number input area in the ribbon display and then press the [INPUT] key.



(*1) Drag: A gesture to touch the surface and move your finger up and down without losing contact

Flick: A gesture to quickly run your fingertip across the screen

Rotating the display

Touch the [Menu] tab to rotate the page using  /  in the ribbon display.

Searching for a word

- (1) Touch the [Menu] tab and then [Find] in the ribbon display.
- (2) Input a word to be searched for in the search character(s) input area and press the [INPUT] key.  The page containing the search word appears. The corresponding area is highlighted.
- (3) Touch the  button.  The cursor moves to the next corresponding area. If there is no corresponding area afterwards, search completion message appears.

Note

- (1) If you touch any area other than the search character(s) input area, you cannot input character(s). To input the search character(s) again, touch the search character(s) input area.
- (2) Only alphanumeric characters and symbols can be input for the search character(s).
- (3) When the search reaches the end of the manual, the search is performed returning to the top of the manual. When the search reaches the search start point, search completion message appears.

2.5 19-type Vertical Display Unit and Home Applications

19-type vertical display unit has the expansion applications that display the machine status, software keyboard, etc. in the lower half of the screen in no linkage with the upper half.

The following expansion applications are provided as standard MITSUBISHI specifications:

- ◆Home screen (machine state display)
- ◆Software keyboard
- ◆Software operation panel
- ◆Manuals
- ◆Notepad

MTB unique applications can also be added.

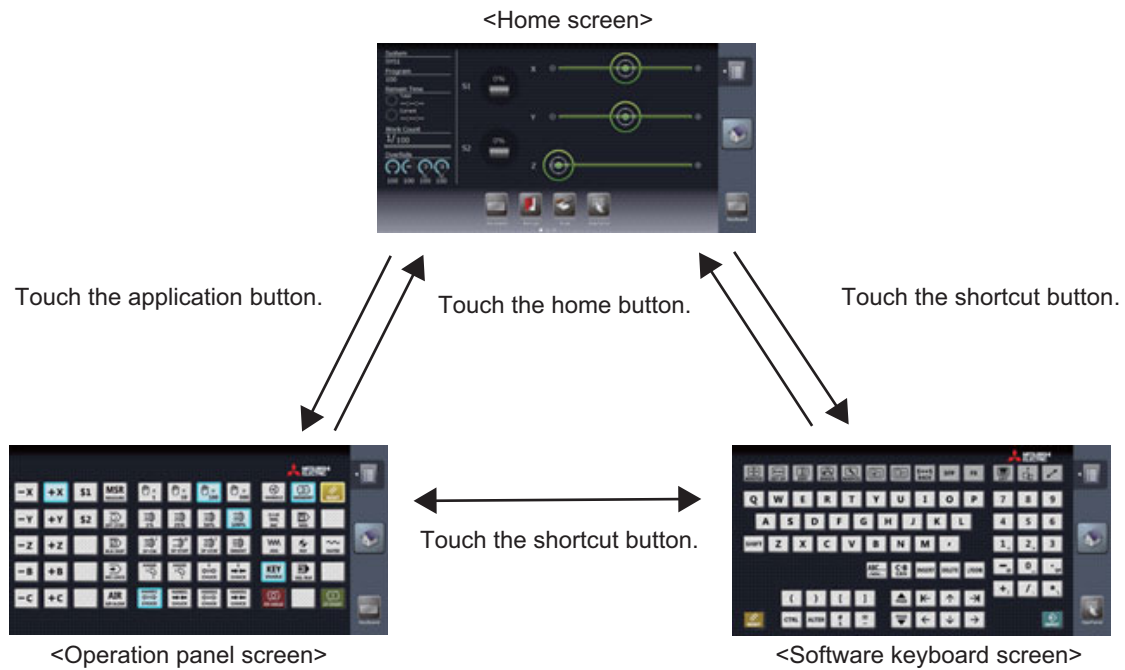

2.5.1 Home Screen (Machine Status Display)

Refer to "2.4.2 Screen Configuration" for details of the display items on the home screen.

Switching to a registered application

The screen can be switched to the registered application by touching the shortcut button or one of application buttons.

Note

(1) The expansion application registered to the shortcut button differs depending on MTB specifications.

Switching to the home screen

Each application screen can be switched to the home screen (machine state display) by touching the home button.

Switching the pages of application buttons

The pages can be switched by flicking the application button area.

Deleting an application button

Each application button can be deleted by touching the delete menu.

- (1) Touch and hold an application button to be deleted for seconds.
- (2) Release your finger when the application button icon becomes the movable state.
- (3) The delete menu appears. Touch the delete menu.
- (4) Touch the [OK] button in the pop-up window to delete the application button.

Rearrange the application buttons

Application buttons can be rearranged by drag-and-drop operation.

Note

(1) When the application buttons on the page you moved are maximum numbers (7 pcs), the latest registered icon goes to next page.

Changing the displayed part system for the home screen

A displayed part system can be switched by selecting the name of part system to be displayed (SYS1, etc.) on the menu [System Switching] of the operation button.

- (1) Touch the operation menu button.
- (2) Touch [System Switching] on the main menu. Selectable part system names are displayed on the sub menu. Select a part system name to be displayed, and the display changes.

Registering an application button

Application buttons can be registered from the application list displayed on the menu [Add Application] of the operation menu button.

- (1) Touch the operation menu button.
- (2) Touch [Add Application] on the main menu.
- (3) The list of applications which can be registered to application button is displayed on the sub menu.
- (4) Touch the application to be registered.
- (5) Touch the [OK] button in the pop-up window to add the application button.

Note

- (1) When the displayed page contains the maximum number of application buttons (seven buttons), the button will be added to the end of next or succeeding page which contains the application buttons less than seven. The page of which the application button is added is displayed.
- (2) If all pages contain the maximum number of application buttons (seven buttons), the error message appears.

Displaying the application version

The version of application for 19-type vertical display is displayed by [Version] of the operation button.

2.5.2 Keyboard Application

The keyboard application enables the key input by touching buttons.

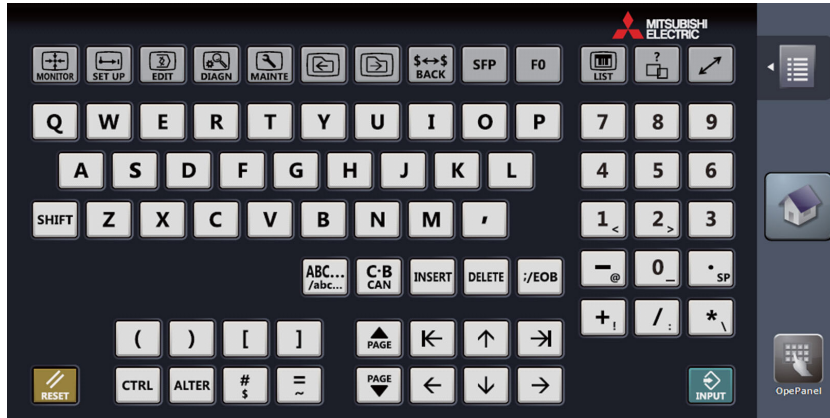

Display items

For details on the keys, refer to "2.1 Display Unit and Keyboard Unit".

This section explains only keys which have different meanings with the keyboard application.

Key type	Key	Operation
Window operation key		Displays the menu list window.
		Displays the parameter/operation guidance window.
	SHIFT +	Switches the prototype screen and mass production screen.
	SHIFT +	This varies depending on the MTB specifications.
		Switches the active window.
Shift key	SHIFT	Enables the lower column of each key. Once the [SHIFT] key is selected, the [SHIFT] key remains in effect until any other keys are touched or the home screen is restored. The menu is highlighted while the [SHIFT] key is enabled.
F0 key	F0	Displays the on-board screen or MTB created screen. <Note> ♦ This action differs depending on MTB specifications
Modifier key	CTRL ALTER	Once the [CTRL] (or [ALTER]) key is selected, the key remains in effect until any other keys are touched. When the home screen is restored, the [CTRL] (or [ALTER]) key is also canceled.

Note

- (1) For eight types of keys; , , , , , , , and the key is continuously input (key repeat state) during being touched.
- (2) The key is interlocked with the CapsLock key of Windows. By pressing the key, the input characters on the operation panel are also changed uppercase and lowercase.
- (3) The key is input when it is touched. Even when sliding a finger and releasing another key, only first key is input.

2.5.3 Operation Panel Application

The operation panel application enables the same operation as the switches and buttons of the actual machine operation panel, such as operation mode selection, automatic operation start and override setting.

Refer to the instruction manual issued by the MTB for meanings and layout of buttons.

Screen image example



Display items

Display items	Details
Machine operation button	Turns ON the PLC input signal which has been assigned to the button when it is touched. When the PLC output signal which has been assigned to the button becomes ON state, the button turns color that indicates ON state (blue, for example).

Operating the machine on operation panel

- (1) When the machine operation button is touched, the button is changed to the pressed state color, and the X device signal which has been assigned to the button is turned ON. The device signal input is performed the moment the button is touched.
- (2) The button returns to the normal color when the operation panel button is released.

Note

- (1) When the PLC output signal turns ON, the button turns the ON state color (blue in the example above).

2.5.4 Manual Application

The manual application enables to refer to each manual. Text search, page jump with touch operation, zooming in/out display, etc., are available.

There are two display methods for the manual application. This section explains the operation using the display method 1 of the manual application. For the operation using the display method 2, refer to "2.4.5 Displaying the Manuals (M800W Windows-based Display Unit/M80W Windows-based Display Unit)".

Note

(1) The displayed manuals and methods differ depending on the MTB.

Screen image example (file selection screen/manual display screen)

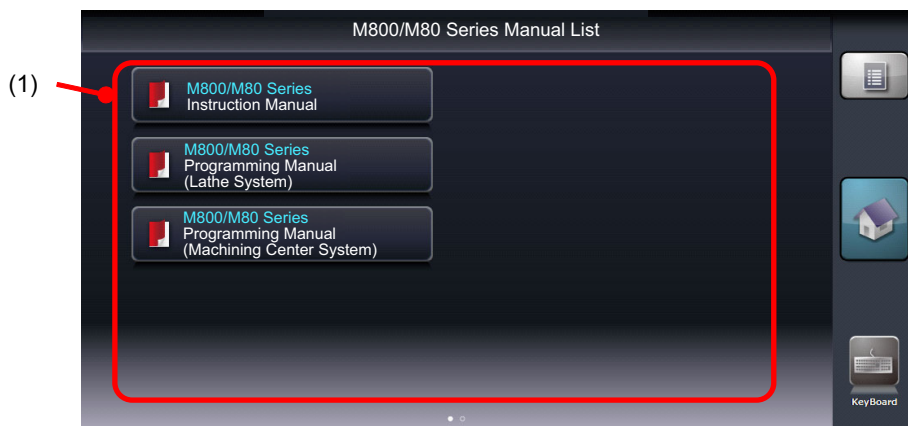

■ Display method 1

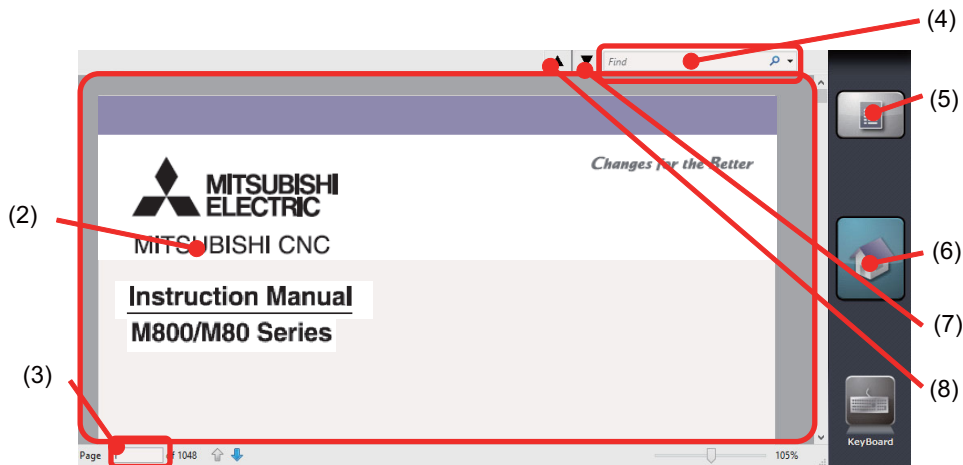

■Display method 2

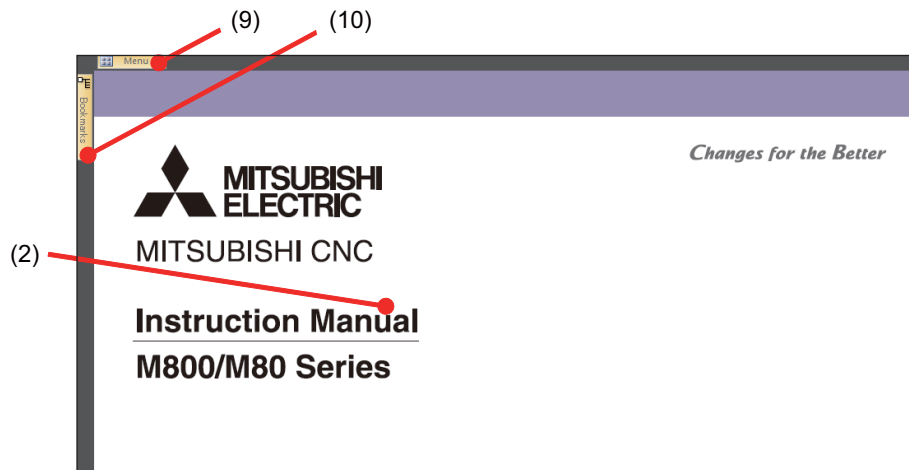

Display items

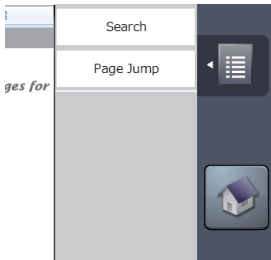
Display items	Details
(1) Manual button	Opens the manual when it is touched.
(2) Main window	Displays the contents of the manual.
(3) Page No. input area	Input a page number for page designation.
(4) Retrieval input area	Input a search string for retrieval.
(5) Operation button	<p>The following menus are displayed by pressing this button.</p> <p>Search: This performs the search.</p> <p>Page jump: This moves to the designated page.</p> 
(6) Home button	Returns to the home screen.
(7) Find next	Displays the next retrieval point.
(8) Find previous	Displays the previous retrieval point.
(9) [Menu] tab	This displays the operation buttons such as page switching, enlarging/reducing, rotation and search.
(10) [Bookmark] tab	This displays the bookmarks of the manual.



Selecting a manual

- (1) Activate the manual application, and the file selection screen appears.
- (2) Flick on the file selection screen to change the page.
- (3) Select (touch) a manual to be referred, and the selected manual is displayed.

Scrolling the manual

Flick the main window. When sliding your finger to up, the page moves to up and next page is displayed.

Searching the characters in the manual

- (1) Touch the operation button on the right of screen.
- (2) The sub menu appears. Touch [Search].
- (3) The cursor appears in the retrieval input area and the screen key board starts.
- (4) Input a search string with the screen keyboard and press the Enter () key. The point at which the search string is found will be displayed.
Press the Enter key again, and next point will be searched.
Touch the close button () in the top right to close the screen keyboard when the screen keyboard becomes unnecessary.

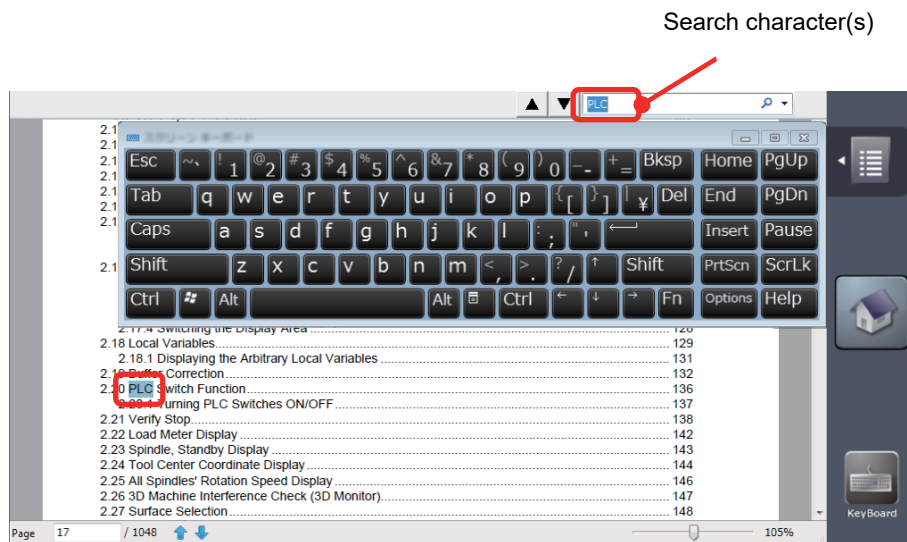

- (5) To continue the retrieval, press the [▼] button to find the next point and press the [▲] button to find the previous point.

Note

- (1) The Caps key of the screen keyboard also switches the upper case/lower case input on the standard screen.
- (2) When the area other than the retrieval input area is touched, the search string cannot be input. To input the search string again, touch the retrieval input area.
- (3) Only alphanumeric characters and symbols can be input.

Displaying the manual by page designation

- (1) Touch the operation button on the right of screen.
- (2) The sub menu appears. Touch [Page Jump].
- (3) The cursor appears in the page number input area and the screen key board starts.

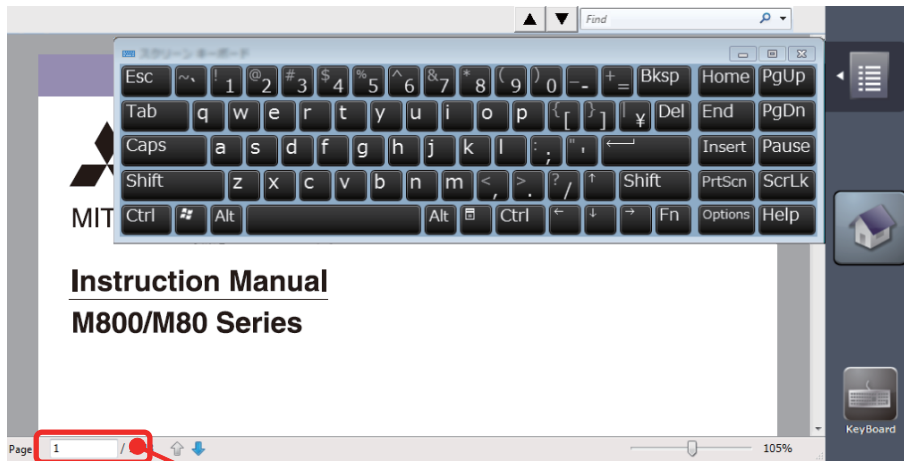

Page No. input area

- (4) Input a page number to be referred and press the Enter key. The designated page is displayed.
Touch the close button in the top right to close the screen keyboard when the screen keyboard becomes unnecessary.

Note

- (1) The front page of the manual file is the first page for the page number designation.

2.5.5 Note Application

The note application enables the hand writing with the touch operation. This can be used as a memo.

The written contents are saved automatically when the home screen is restored, and the contents will be displayed next time the note application is started.

Screen image (when the operation button is pressed)

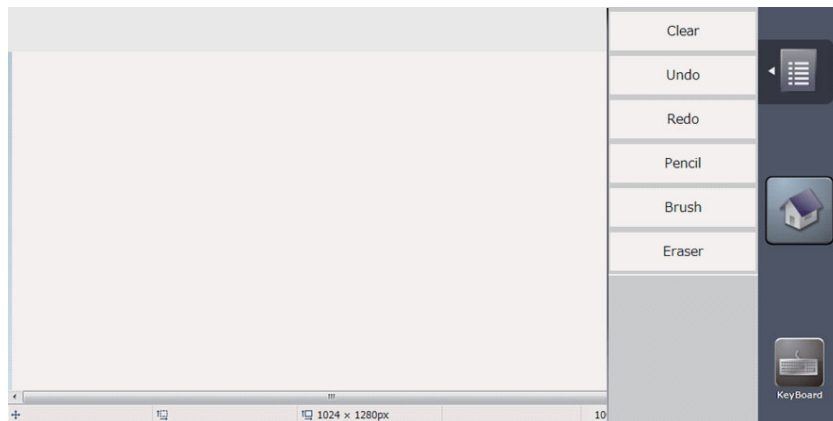

Display items

Display items	Details
Memo area	Characters, etc., can be written by tracing a finger.
Operation button	Performs the all erasure of memo area, undo, and various tools selection.
Clear	Erases all contents in the memo area.
Undo	Cancels a last action.
Redo	Redoes a canceled action.
Pencil	To select the pencil tool for thin lines.
Brush	To select the brush tool for thick lines. This tool is selected when the application is started.
Eraser	To select the eraser tool to erase a part of memo.

Writing a memo

Lines can be drawn with the selected tool by tracing your finger in the memo area.

When the note application is started, the brush tool which is used for drawing thick lines is selected.

Delete all contents of memo

- (1) Touch the operation button on the right of screen.
- (2) Touch [Clear] on the sub menu.
- (3) The memo area is all deleted and the sub menu is closed.

Undo a last action

Touch [Undo] on the sub menu to cancel a last action.

- (1) Touch the operation button on the right of screen.
- (2) The sub menu appears. Select [Undo] on the sub menu.
- (3) One action will be undone.

Note

- (1) When no action is performed after the application is started from the home screen, the [Undo] action cannot be performed because there is no action can be canceled.
- (2) Once the home screen is restored, the previous action cannot be canceled.
Available undo actions are as follows.
 - Action between drawing a line and releasing a finger
 - Action between erasing a line and releasing a finger
 - [Clear] action
 - [Redo] action
- (3) Use [Redo] to cancel the [Undo] action.
- (4) Up to 50 actions can be undone.

Redo a canceled action

Touch [Redo] on the sub menu, and the canceled action can be redone.

- (1) Touch the operation button on the right of screen.
- (2) The sub menu appears. Select [Redo] on the sub menu.
- (3) One action taken back by the [Undo] action will be redone.

Note

- (1) When no action is performed after the application is started from the home screen, the [Redo] action cannot be performed because there is no undo action performed.
- (2) The [Undo] action can be redone by touching [Redo], however, once the home screen is restored, the [Undo] action cannot be redone.

Selecting the line width

- (1) Touch the operation button on the right of screen.
- (2) The sub menu appears. Touch [Pencil] or [Brush] on the sub menu.
- (3) Touch [Pencil] to select the pencil tool to draw the thin lines, or touch [Brush] to select the brush tool to draw the thick lines.

Note

- (1) The tool selection is not held after the home screen is restored. The brush tool is selected with the note application start-up.

Erasing a part of memo

- (1) Touch the operation button on the right of screen.
- (2) The sub menu appears. Touch [Eraser] on the sub menu.
- (3) The eraser tool is selected. Only the part traced with finger can be erased.
- (4) Select the pencil tool or brush tool to draw the lines again.

Note

- (1) The tool selection is not held after the home screen is restored. The brush tool is selected with the note application start-up.

2.6 Setting Data

2.6.1 Setting Numerals and Alphabetical Characters

Operation method

The data is basically set with the following methods:

- (1) Menu selection
- (2) No. selection
- (3) Cursor movement
- (4) Data key input
- (5) [INPUT] key input

Note

- (1) The contents in the data setting area are only displayed until the [INPUT] key is pressed. These contents are invalidated if the screen is changed. The data is written into the memory when the [INPUT] key is pressed.
- (2) Special settings may be required depending on the data type. Refer to each item.
- (3) The cursor may move to the right of the display item depending on the data type.
- (4) If an illegal key is set, an error occurs when [INPUT] is pressed. Reset the correct data.

Operations in the data setting area

The key is input at the position where the cursor is displayed. If a cursor is not displayed, the key input is invalid. When a key is input, the data appears at the cursor position, and the cursor moves one character space to the right.

[→]/[←] keys: Moves the cursor one character to the left or right.

[INSERT] key: Enters the insert mode.

The mode returns to the overwrite mode when the [DELETE], [C.B CAN] keys are pressed, or when the screen is changed.

[DELETE] key: Deletes the character in front of the cursor.

[C.B] key: Deletes all characters in the data setting area.

Cursor operations on the screen

If a cursor is displayed on the screen, data is set in the data setting area and the [INPUT] key is pressed, the data appears at the cursor position on the screen. The cursor moves to the next position.

The following keys can be used to move the cursor with the cursor keys.

: Moves the cursor to the previous line.

: Moves the cursor to the next line.

: Moves the cursor one item to the left.

: Moves the cursor one item to the right.

2.6.2 Inputting Operations

In addition to the method of directly inputting numeric data for specific data settings, a method to input the operation results using four rules operators and function symbols can be used.

Input method



Numeric values, function symbols, operators and parentheses () are combined and set in the data setting area.

The operation results appear when the [INPUT] key is pressed. Data for the currently selected setting item will be set when [INPUT] key is pressed again. The contents in the data setting area are erased.

Examples of operator settings, and results		
Operation	Setting example	Operation results
Addition	=100+50	150
Subtraction	=100-50	50
Multiplication	=12.3*4	49.2
Division	=100/3	33.3333333
Function	=1.2 * (2.5 + SQRT(4))	5.4

Function symbols, setting examples and results			
Function	Function symbol	Setting example	Operation results
Absolute value	ABS	=ABS(50 - 60)	10
Square root	SQRT	=SQRT(3)	1.7320508
Sine	SIN	=SIN(30)	0.5
Cosine	COS	=COS(15)	0.9659258
Tangent	TAN	=TAN(45)	1
Arc tangent	ATAN	=ATAN(1.3)	52.431408

Operation examples

- (1) Set as shown below, and press the [INPUT] key.  The operation results appear in the data setting area.
=12*20 [INPUT] 240
- (2) Press the [INPUT] key again.  Data for the selected setting item is set.
The result is displayed on the screen.
The cursor moves to the next position.

Notes for using operators and functions

Division: Zero division causes an error.

Square root: If the value in the parentheses is negative, an error occurs.

Trigonometric function: The unit of angle θ is degree ($^{\circ}$).

Arc tangent: $-90 < \text{operation results} < 90$.

Restrictions

- (1) Always use "=" for the first character.
- (2) Do not use the following characters as the second character or last character.
Invalid as second character: * , /,)
Invalid as last character: * , /, (, +, -
- (3) Make sure that the left parentheses and right parentheses are balanced.
- (4) The 360° limit does not apply on the angle. SIN (500) is interpreted as SIN (140).
- (5) While the monitor screen or the setup screen displaying, if the axis name address, M, S, T, 2nd miscellaneous function code (B, etc.) is pressed when "=" is set in data setting area as the first character, the operation input is given to priority. So, the window does not open, and the cursor does not move.
- (6) The exponential setting, like "1.23E-4", cannot be used. The operation result is not displayed with exponential.
- (7) It is not possible to set characters exceeding the number of characters which can be input to the data setting area.
- (8) It is not possible to omit "0" before the decimal point, like ".5", when operation inputting. An error will occur.
- (9) The accuracy is guaranteed for the calculation with 15 digits or less. The calculation with over 15 digits does not guarantee its accuracy.
- (10) The operator or the function which does not exist in the above-mentioned, such as "ASIN", cannot be used. The operation message "Setting error" appears, and the display of the data setting area does not change.
- (11) Regardless of the input setting unit and metric system/inch system, the digit numbers below the decimal point of the operation result is seven digits or less.

2.7 Guidance Function

2.7.1 Parameter Guidance

The parameter guidance function displays the details of the parameters according to the state of the screen currently being displayed.

Screen Configuration

The parameter/alarm guidance window is displayed with the following type of configuration.

- 8.4-type/10.4-type

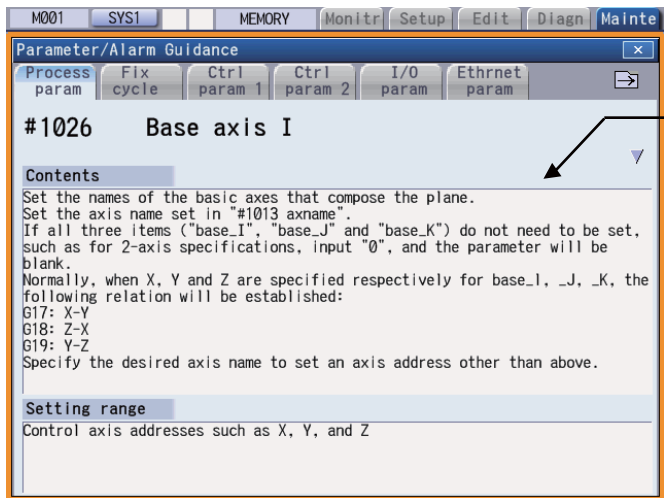

The parameter No., name, details and setting range are displayed.

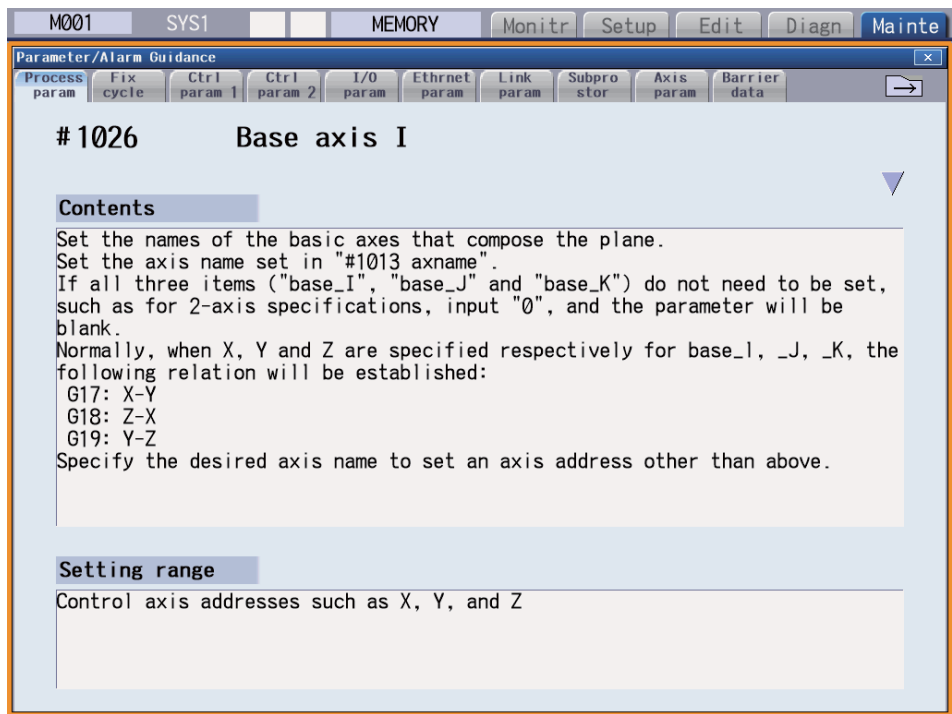

- 15-type/19-type









Operation method

If the [?] key is pressed on any screen, the guidance window will open. If a pop-up window other than the guidance window is open, the guidance window will open over the currently opened pop-up window. In this case, the menu state does not change. If [?] key or [CANCEL] key is pressed again when the guidance window is open, the guidance window will close and the screen will return to the previous state in which the [?] key was pressed.

Displaying the parameter guidance (Example: "#8005 ZONE r")

- (1) Press the menu [Param] on maintenance screen.  The parameter screen is displayed.
- (2) Press the [↓] key, and move the cursor to "#8005 ZONE r" parameter.
- (3) Press the [?] key.  The guidance window is opened, and the detail of "#8005 ZONE r" parameter is displayed.

Note

- (1) The contents of the parameter "#8004 SPEED" (the previous parameter on the parameter screen) are displayed by pressing the  key. However, when the  key is pressed on the first parameter of each parameter type, the displayed contents do not change. The contents of the parameter "#8006 ZONE d" (next parameter on the parameter screen) are displayed by pressing the  key. However, when the  key is pressed on the last parameter of each parameter type, the displayed contents do not change.
Pressing the [↑] or [↓] key scrolls the explanation contents of the parameter guidance in a page unit. When the [↓] key is pressed while the last line is displayed, next guidance appears. When the [↑] key is pressed while the top line is displayed, the previous guidance appears.
However, when the [↑] key is pressed while the first parameter guidance is displayed, or when the [↓] key is pressed while the last parameter guidance is displayed, the display does not change.
- (2) The contents of the first parameter for the fixed cycle parameter are displayed by pressing the  key. While the parameter guidance window is displayed, the displayed parameter contents are recorded for each parameter type. When the parameter type is changed with  /  key, the contents of the previously displayed parameter are displayed.
- (3) When the parameter No. could not be acquired (when the cursor was non-display or was on a blank or comment line), the top of parameter guidance for each parameter appears.
- (4) The parameters whose contents/setting range are similar or same are collectively displayed.
(Example: PLC integrated timer)
- (5) For machining condition parameters on the machining condition setting screen, the cursor position does not move after opening and closing the parameter guidance.

Precautions

- (1) If the [?] key is pressed when alarm occurs, the alarm guidance window will open.
- (2) Once the guidance data is read, the guidance can be displayed even when the memory card is removed.
- (3) Press the [?] key on a screen other than [Mainte] - [Param] and [Setup] - [User] when an alarm is not being occurred, and the head parameter guidance of parameters is displayed.

2.7.2 Alarm Guidance

The alarm guidance is the function that displays message, details and remedy for the currently occurring alarms and the alarms being displayed on the alarm history screen.

Screen Configuration

The alarm guidance is displayed in "alarm" tab on "parameter/alarm guidance window".

The "alarm" tab is on the rightmost end of the guidance window.

A scroll bar appears when details and remedy, etc. do not fit in one page.

- 8.4-type/10.4-type

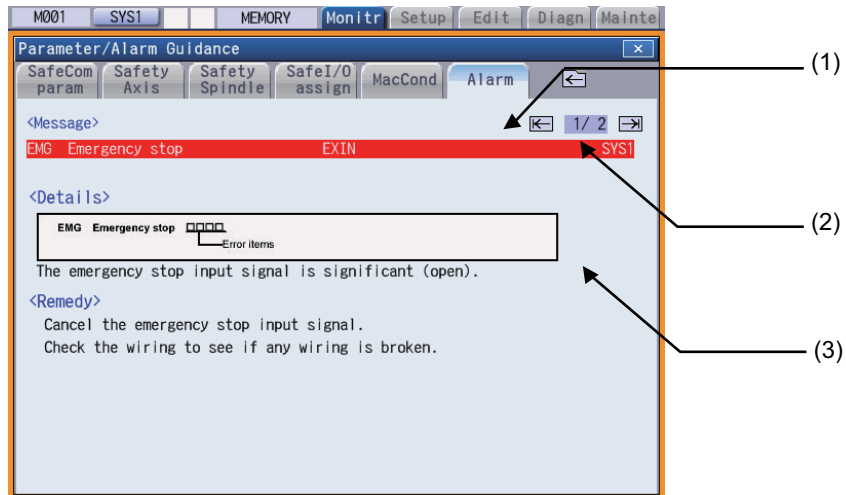

- 15-type/19-type

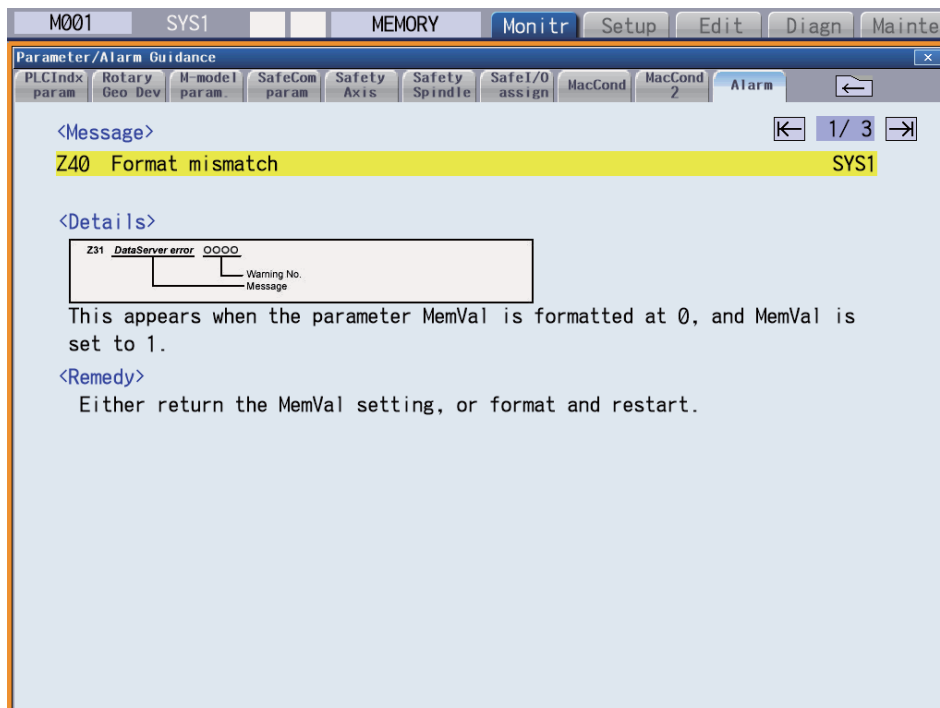

Display items

Display items	Details
(1) Messages	This displays "NC alarm" and "PLC alarm message" for the currently occurring alarm and the alarm being displayed on the alarm history screen. The displayed content is same as the content displayed in the alarm message of the diagnosis screen.
(2) Number of page	<ul style="list-style-type: none"> ◆When the guidance of currently occurring alarm is being displayed This displays "order of priority / total number of occurring alarms". ◆When the guidance of the alarm history is being displayed "Alarm number counted from the top/maximum number of the alarms which can be displayed" is displayed.
(3) Details/Remedy, etc.	This displays detail and remedy, etc. for alarm message.

Operation method



All alarms are displayed for alarm guidance regardless of part system.

If the [?] key or the  key is pressed on any screen when an alarm occurs or when the alarm history screen is displayed, alarm guidance window will open.





If a pop-up window other than the guidance window is open, the guidance window will open over the currently opened pop-up window. In this case, the menu state does not change. If [?] key or [CANCEL] key is pressed again when the guidance window is open, the guidance window will close and the screen will return to the previous state in which the [?] key was pressed.

While the alarm history screen is being displayed, the guidance for the alarm displayed on the screen is displayed even if any other alarm occurs.

Displaying the alarm guidance

- (1) Press the [?] key or the  key during occurring alarm on monitor screen.  The guidance window is opened while "alarm" tab is valid. The alarm details and remedy are displayed for "H/W stroke end axis exists".
(Example) When "H/W stroke end axis exists" and another alarm occur.

Note

- (1) Pressing the  or  key scrolls the explanation contents by page.
- (2) Pressing the [↑] or [↓] key scrolls the explanation contents in a line unit.
- (3) When each parameter tab, such as the parameter, fixed cycle parameter, etc., is opened with the  key, the contents of first parameter in each parameter tab is displayed.
- (4) The alarm guidance is executed for the alarm that occurs when the [?] key or the  key has been pressed. Therefore, the guidance is not displayed for the alarm that has been handled or has occurred while the alarm guidance is displayed.
- (5) If the [?] key is pressed when an alarm is not occurring, the parameter guidance appears. In this state, if the "alarm" tab is selected with the  key, nothing is displayed in the alarm guidance panel. (These columns are blank.)
- (6) All the explanations of the alarm having the same error class and No. are displayed in the details column.
- (7) When no alarm or only one alarm occurs, the arrow next to the page number is not displayed.

Changing the alarm guidance

- (1) Press the [→] key or [→] key when the alarm guidance is displayed. →

The alarm guidance with one priority lower than the current alarm guidance is displayed.

If the [→] key or [→] key is pressed when the lowest priority alarm is displayed, the alarm with the highest priority is displayed.

(Example) When 3 alarms occur.

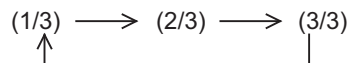

- (2) Press the [←] key or [←] key when the alarm guidance is displayed. →

The alarm guidance with one priority higher than the current alarm guidance is displayed.

If the [←] key or [←] key is pressed when the highest priority alarm is displayed, the alarm with the lowest priority is displayed.

(Example) When 3 alarms occur.

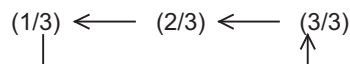
**Note**

- (1) Up to 18 alarm or warning messages can be displayed for alarm guidance from highest priority.
(The messages are displayed in order of NC alarm or warning message (10 messages maximum) -> PLC alarm message (four messages maximum) -> NC alarm message for background check (four messages maximum).)
- (2) Even if the [→], [←], [←] or [→] key is pressed when only one alarm occurs, the screen display is not switched.

Precautions

- (1) The alarm guidance of stop code and operator message is not displayed.
- (2) The PLC device information, which is displayed for the PLC alarm message guidance, displays the PLC device status when the alarm guidance is displayed. Accordingly, even if the device value changes when the alarm guidance is being displayed, the displayed PLC device information is not updated automatically. To update the information, close the alarm guidance once and display it again by pressing the [?] key again. However, when the PLC device information is redisplayed with [→], [←], [←] or [→] key at occurrence of multiple alarms, the PLC device information is updated.
- (3) Once the guidance data is read, the guidance can be displayed even when the memory card is removed.

2.7.3 G Code Guidance

G code guidance is a function that shows the command format details or the outline of its operation for the G code being edited while creating or editing the machining program. With this function, the G code format can be confirmed immediately. G code guidance is also displayed in the same manner even when MDI program is displayed.

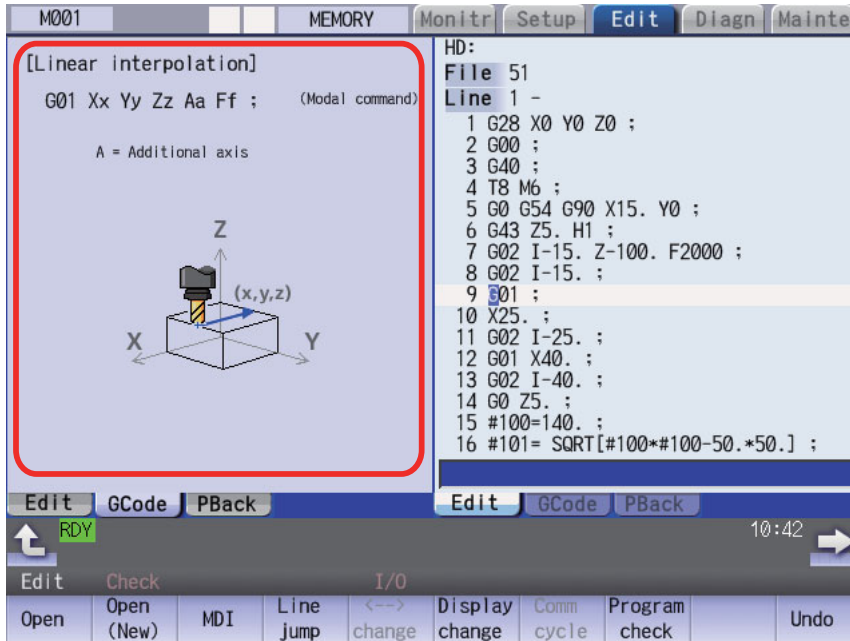

G code displayed in the G code guidance area is refreshed as the cursor moves across the program edit screen. When you change the available edit area during simultaneous program edit (3 programs), G code guidance is also refreshed.

The G code that meets following conditions are displayed in this area.

- G code that exists between the head of block and cursor position including the cursor position.
- G code that exists immediately before the cursor if multiple G codes meet the above condition.

Specific example

- | | | |
|-------------------------|---|--|
| G91 G17 ; █ | ➔ | The guidance is not refreshed because the cursor is out of the block. |
| G91 G17 █ █ | ➔ | The guidance for G17 is displayed. |
| G91 █ G17 ; | ➔ | The guidance for G91 is displayed. |
| G91 G00 X100. █ Y100. ; | ➔ | The guidance for G00 is displayed because G00 is the nearest G code to the cursor. |

G codes displayed in the G code guidance area

With G code guidance function, the commands having "G" followed by 1 or more numbers are regarded as the G code. Thus, when "G" that is located immediately before the cursor is within the comment, the guidance will not be refreshed. In the same manner, when a G code is commanded using variables such as "G#100" or "G#500", etc. but numbers, the guidance will not be refreshed.

The G code that can be displayed in the guidance area is as follows.

Gnnnnnnn.m L ll ("n", "m", and "l" are arbitrary number.)

Commanded value	Number of valid digits	Remarks
n (integer)	1 to 8 digit	When including "0" before integer command value, unnecessary "0" is ignored.
m (decimal places)	0 to 1 digit	-
l (value commanded using "L")	0 to 2 digit	This is valid when "L" exists immediately after the integer command value or decimal command value and is followed by a command value. If the command with "L" address precedes G code, the "L" command will not be described in the guidance.

Note

(1) As for the G codes not included in the specifications, the guidance is not displayed even if the above condition is met.

- G00 X100. (GCODE) ; ➔ "G" included in the comment "GCODE" is ignored, thus, G code guidance is not refreshed.
- N11 GOTO1 ; ➔ "G" included in the command "GOTO" is ignored, thus, G code guidance is not refreshed.
- G91 G120 X100 Y100. ; ➔ G code "G120" is not included in the specifications, thus, G code guidance is not refreshed.
- G00000031.1 ; ➔ The guidance for G31.1 is displayed.
- G00000031.10 ; ➔ Commanded value exceeds the number of valid digits, thus, G code guidance is not refreshed.
- L50 G10 ; ➔ The guidance not for "G10 L50" but "G10" is displayed.

2.8 Menu List

The menu list is a function that displays each screen's menu configuration as a list. The Menu list window opens when the



key is pressed on each screen.

If a pop-up window other than the menu list is displayed, the Menu list window appears above the displayed pop-up window. The menu does not change in this case.





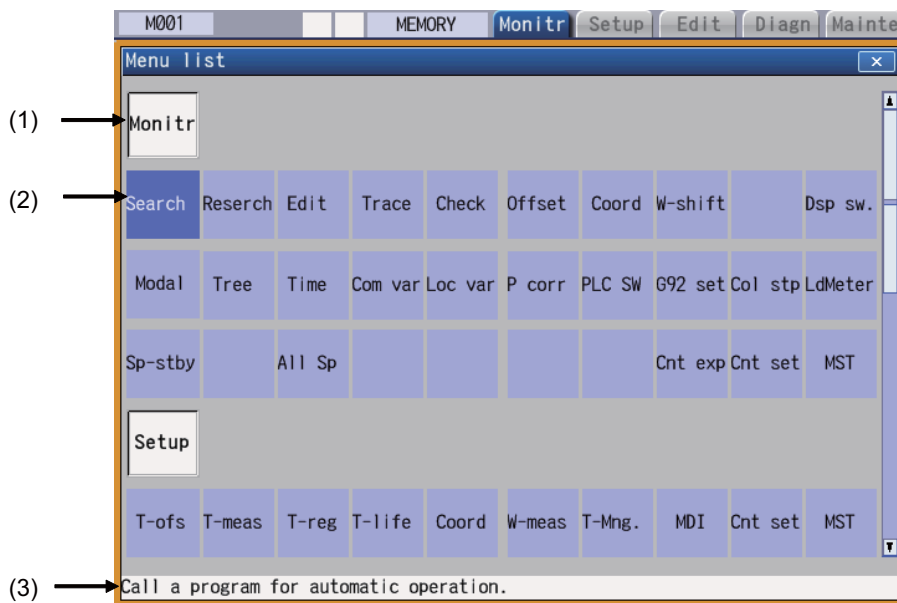



If the key is pressed again while the Menu list window is open, the Menu list window closes, and the state before the key was pressed is recovered.



Display items

Display items	Details
(1) Screen name	The screen name is displayed. (Example) Monitr/Setup
(2) Menu name	A list of the menu names (functions) included on each screen is displayed. (Example) Search/Reserch
(3) Function outline display area	An outline of the currently selected menu name (function) is displayed.

Operation method

- (1) Press the  key.  The Menu list window appears showing the selected screen's menu list at the top.
- If you press the  key while editing the file on the edit screen, a prompt to confirm whether to save the program appears before Menu list window opens.
- (2) Using the [↑], [↓], [→], [←], and page keys, move the cursor to the menu for which the function outline is to be displayed.  The function outline for the selected menu appears. The function outline does not appear if a menu with no name is selected.
- The cursor does not move to the group name.
- Each cursor key moves as follows.
- [↑] key: The cursor moves up.
- [↓] key: The cursor moves down.
- [→] key: The cursor moves to the right.
- [←] key: The cursor moves to the left.
-  key: The screen scrolls down.
-  key: The screen scrolls up.
- <Note>
- Pressing the [←] key also moves the cursor in the same way as the [←] key.
 - Pressing the [→] key also moves the cursor in the same way as the [→] key.
- (3) Press the [INPUT] key.  The selected menu function can be moved to directly. The menu is not moved to if a menu with no name is selected. The Menu list window closes after moving.

When using the touchscreen display, touching it once activates the menu where you touched. And then touch the menu again or press the [INPUT] key to display the menu screen.

2.9 Touchscreen Functions

Touchscreen operation is available with a touchscreen display.

2.9.1 Basic Operation

- 10.4-type

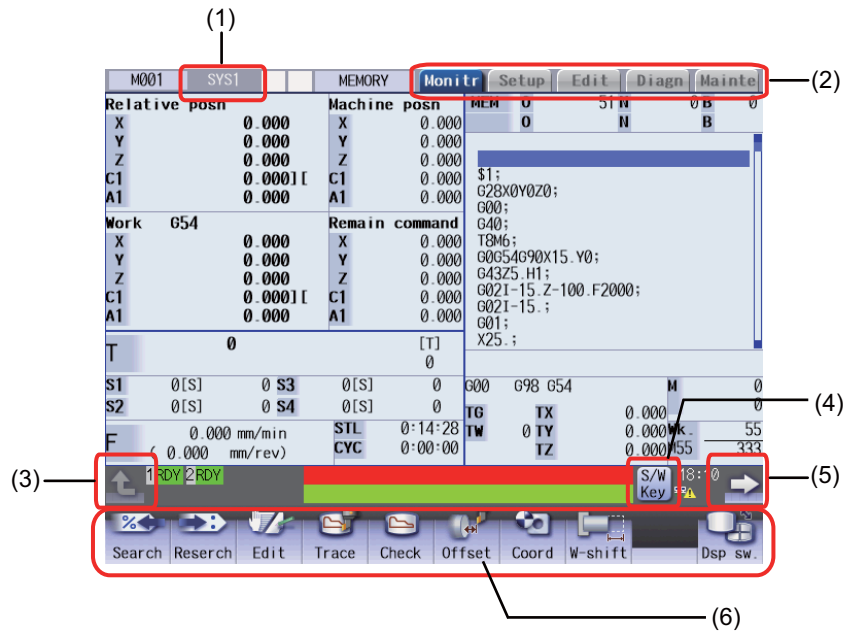

- 15-type/19-type

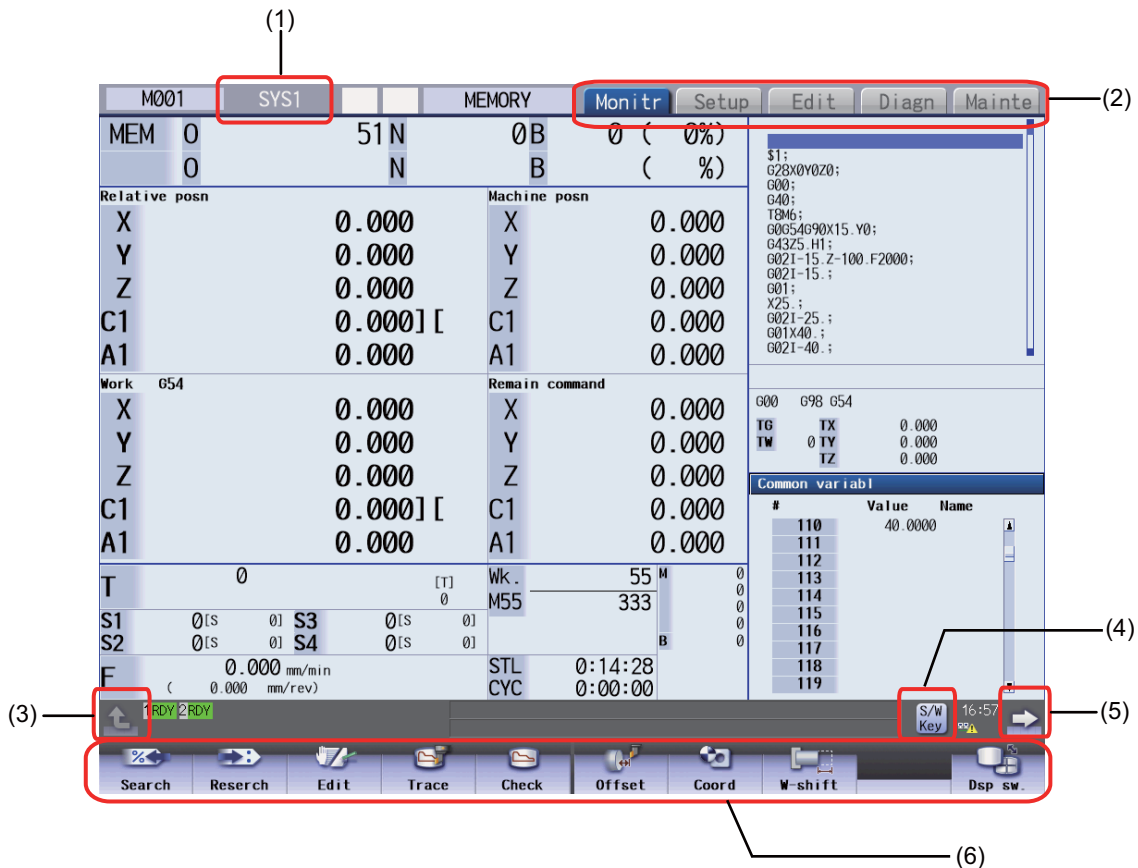

Display items

Display items	Details
(1) System change	This switches from the current part system to the next part system.
(2) Function change	A selected screen will open. As in the case with a screen change by key inputting, if a pop-up window is displayed, close it before changing screens. If there is a file under editing, confirm if the file is saved before changing screens.
(3) Menu operation cancel	The displayed screen operation menu is switched to the screen selection menu of the current screen group. This is also used to cancel the menu operations of the displayed screen.
(4) Software keyboard display	This displays the software keyboard on the screen.
(5) Menu change to the next	This switches to the next menu if available.
(6) Menu selection	When a menu is selected by touching, the menu's process is executed.

Page changing area by scroll bar

If you touch [▲] or [▼] of the scroll bar, the screen is scrolled up or down by one line. Also, if you touch the empty portion of the scroll bar, the page is switched to the next page or previous page.

Pages cannot be changed by dragging the slider.

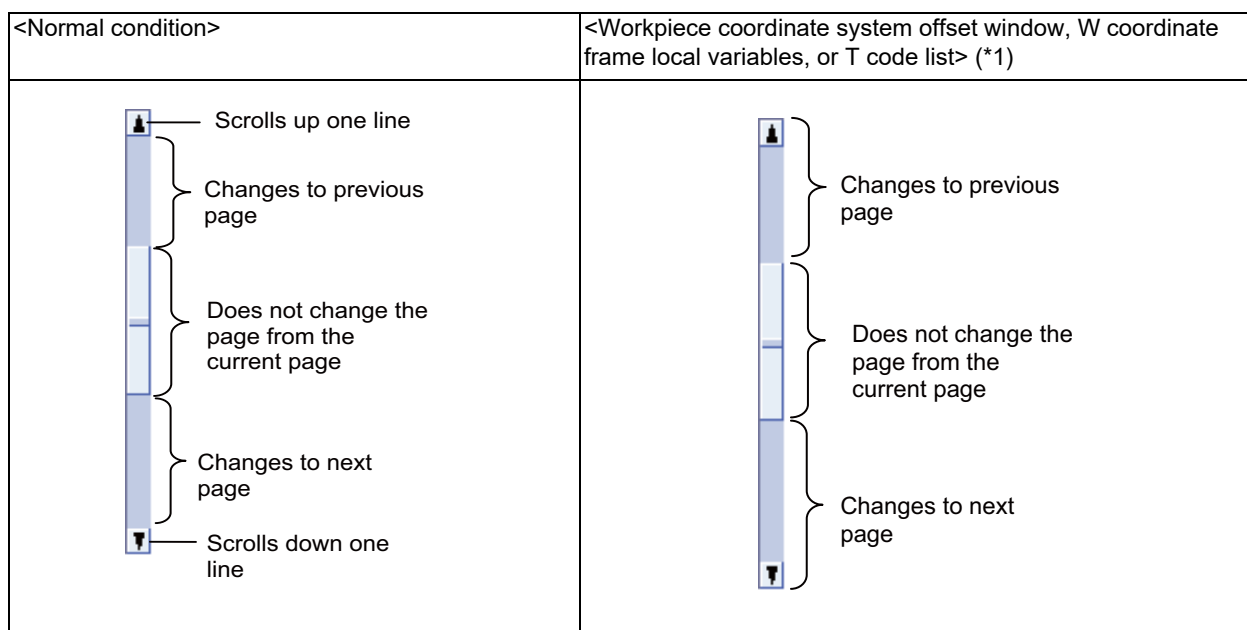

(*1) For the workpiece coordinate system offset window and local variable window on the monitor screen as well as coordinate system offset frame and T code list window on the setup screen, the page changes to the previous page when [▲] of scroll bar is touched, and the page changes to the next page when [▼] of scroll bar is touched. (It is not possible to scroll in a line unit.)

Disable touchscreen operation

When the touchscreen needs to be disabled, set the parameter "#1480 tp_invalid" (Disable touch panel operation) to "1", or turn the touchscreen operation invalidation signal ON. Refer to the instruction manual issued by the MTB for details.

2.9.2 Software Keyboard

With the software keyboard, a key input is possible by a key menu on the software keyboard which is displayed on the screen. Software keyboard is displayed if [S/W Key] button is touched in each screen. In this case, screen or menu status will not change. Software keyboard is always displayed on the front screen. When the [CLOSE] key on the software keyboard is touched, the software keyboard will be closed.

Software keyboard is enabled when the parameter "#11010 Software keyboard" is set to "1", "2" or "3". Even if the parameter is "0", software keyboard can be used when the keyboard has not been connected. When software keyboard is disabled, [S/W Key] button is not displayed.

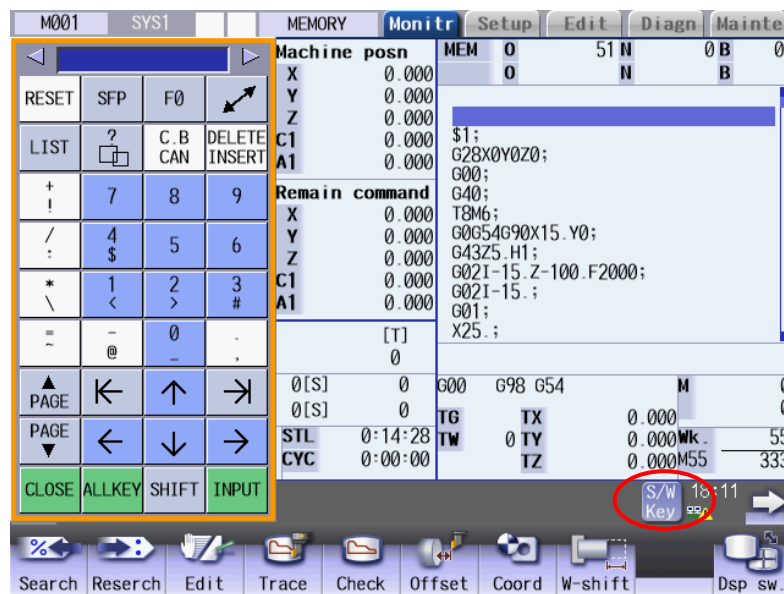
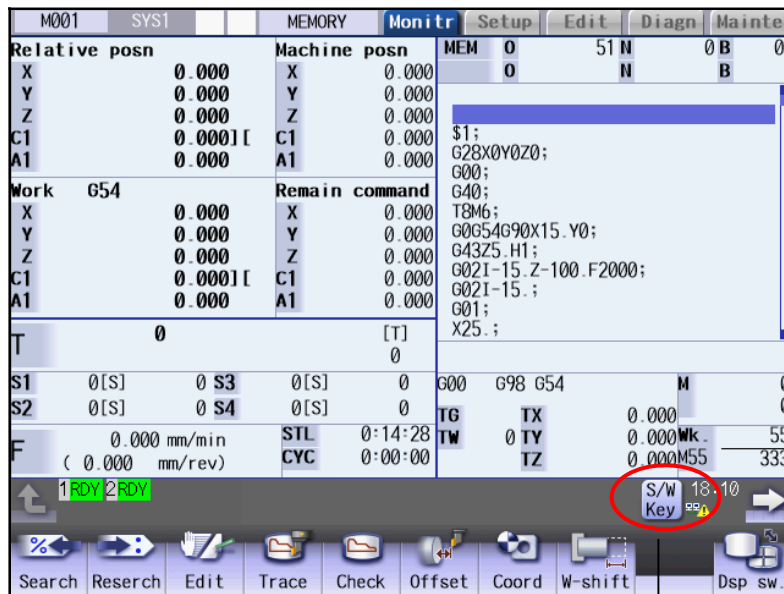

During the software keyboard is displayed, the [S/W Key] button is inverted.

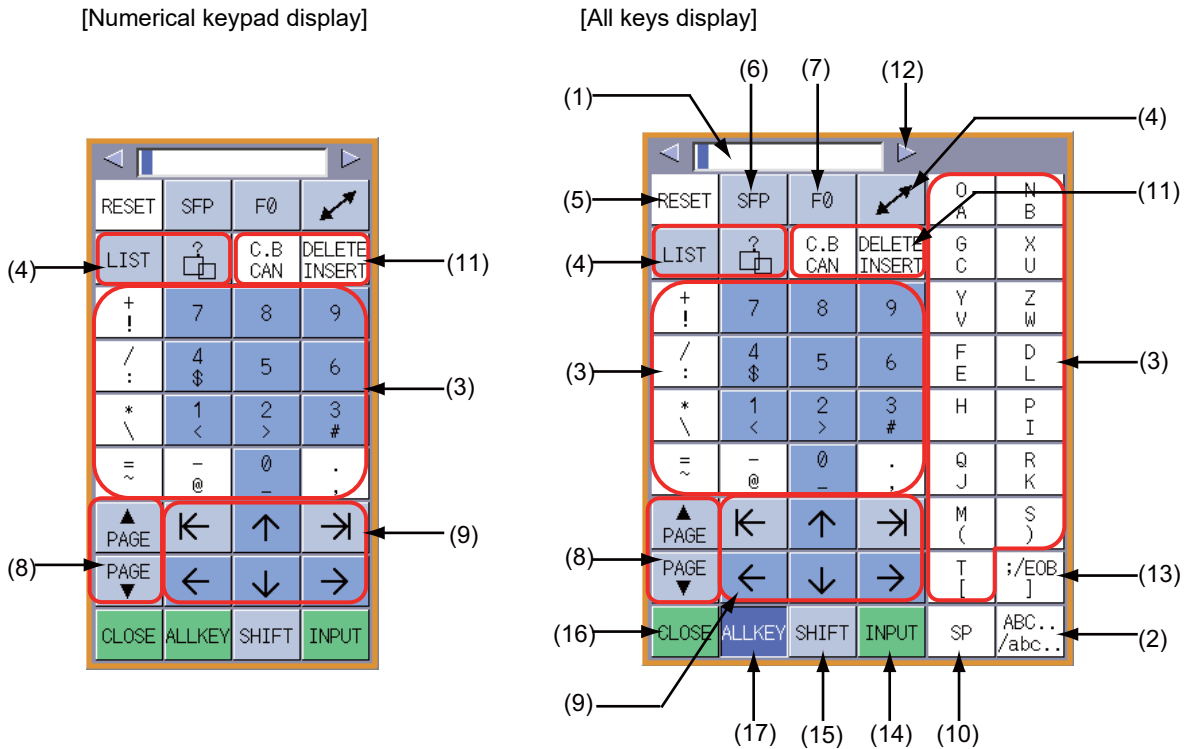

Display items

Display items	Details
(1) Input section	This displays a character string according to the keys touched by the operator.
(2) Lower-case letter input key	This changes upper/lower-case of alphabet. The [ABC../abc..] key is highlighted when the lower-case-letter-setting is valid.
(3) Data setting keys	This enters characters in the input area or screen.
(4) Window operation keys	[LIST]: This displays the menu list window. [?]: This displays the parameter/guidance window. [SHIFT] key + [LIST]: Switches the prototype screen and mass production screen. [SHIFT] key + [?]: Displays the custom screen (*1). ↔ : This changes active windows.
(5) RESET key	This resets the NC.
(6) SFP key	This displays the custom screen (*1).
(7) F0 key	This displays the onboard screen or custom screen (*1).
(8) Page up/down keys	This displays the contents in the previous/next page. When the numerical keypad display keyboard is displayed automatically at the time of Yes/No confirmation, [Y]/[N] keys are displayed instead of page up/down keys.
(9) Cursor keys	If data is set in the display items on the screen, the cursor is moved to vertically/horizontally.
(10) Blank key	This enters a blank.
(11) Data correction keys	[INSERT]: The mode changes to data insertion mode, and characters are input at the current cursor position when data setting key is pressed. When [DELETE], [C.B CAN], [INPUT], cursor key, or tab key, etc. is pressed, or when the screen is changed to another, the mode returns to overwriting mode. [DELETE]: This deletes a letter before the cursor position. [C.B]: This cancels the settings in the input area. [CAN]: This cancels.
(12) Display position switch	This switches the display position of the software keyboard.
(13) Block end key	This enters ";".
(14) INPUT key	This confirms the data entered in the input area or screen.

Display items	Details
(15) SHIFT key	This validates the setting on the lower line of the data setting key. Once [SHIFT] key is selected, it will be valid until another key is pressed or the software keyboard is closed. Menus are displayed in highlight while [SHIFT] key is valid.
(16) CLOSE key	This closes the software keyboard.
(17) Key display switch key	This switches numerical keypad display/all keys display.

(*1) Operations vary depending on the MTB specifications.

Input area of software keyboard



If the software keyboard is displayed while the input area exists on the screen, the input area of the software keyboard is displayed in the enable state. When the data setting key or data correction key is selected while the input area is enabled, enter a key in the input area of the software keyboard, and use the [INPUT] key to enter data in the screen.

Furthermore, if the software keyboard is displayed to edit a program file when the input area does not exist on the screen or while the editing window or MDI editing window is being displayed, the input area of the software keyboard is displayed into the disable state. In this case, directly enter a key in the screen.

When you enter a key to type the password, an asterisk "*" appears in the input area of the software keyboard.



Displaying/closing the software keyboard

Touching the [S/W Key] button on the lower left of the screen allows you to display the software keyboard on the screen.

- (1) Touch the [S/W Key] button.  The software keyboard is displayed on the front screen. The [S/W Key] button is highlighted.
- (2) Touch the [CLOSE] key.
Or, touch the [S/W Key] button again.  The software keyboard will close.



Switching the view mode (all keys display/numerical keypad display)



Touching the [ALLKEY] key on the software keyboard allows you to switch the software keyboard view mode between "numeric keypad view" and "all key view". "Numeric keypad view" is specified by default.





- (1) Touch the [S/W Key] button.  The software keyboard is displayed on the left side of the screen.
The software keyboard is displayed as a numerical keypad.
- (2) Touch the [ALLKEY] key at the bottom of the software keyboard.  All keys, including alphabet character keys, are displayed.
The [ALLKEY] key is highlighted.
- (3) Touch the [ALLKEY] key at the bottom of the software keyboard.  The display is switched to the numerical keypad only.
The [ALLKEY] key is unhighlighted.

Changing the display position

The software keyboard can be relocated using one of the following methods:

- Touch the  or  key at the top of the software keyboard.
The software keyboard moves to the three fixed positions: left, middle or right.
- Drag or flick on the software keyboard
Drag the screen (touch the surface and move your finger vertically/horizontally without losing contact) or flick the screen (quickly run your fingertip vertically/horizontally across the screen) to move the keyboard to any desired position.





■ Touch the  or  key at the top of the software keyboard.

- (1) Touch the [S/W Key] button.  The software keyboard is displayed on the left side of the screen.
The [S/W Key] button is highlighted.
- (2) Touch the  key located at the upper right corner of the software keyboard.  The software keyboard moves to the right, and it appears on the center of the screen.
- (3) Touch the  key located at the upper right corner of the software keyboard.  The software keyboard moves to the right, and appears on the right side of the screen.

Note

- (1) When the  key is pressed, the software keyboard moves to the left.

■ Drag or flick on the software keyboard

- (1) Touch the [S/W Key] button.  The software keyboard is displayed on the left side of the screen.
The [S/W Key] button is highlighted.
- (2) Drag or flick in the lower right direction on the software keyboard.  The software keyboard moves in the lower right direction.
- (3) Touch the  key located at the upper right corner of the software keyboard.  The software keyboard moves to the right, and appears on the right side of the screen.

Entering data when the input area is enabled

If displaying the software keyboard while input area is being displayed on a screen, such as in the case where the operation search window or setup screen is being displayed, the software keyboard input area will be valid. At this time, the key selected on the software keyboard is temporarily displayed in the software keyboard input area, and then is input and set in the screen by selecting the [INPUT] key.

(Example) Set the value in T tool compensation amount

- | | | |
|--|---|---|
| (1) Display T compensation tab on the setup screen and touch the [S/W Key] button. | ➔ | The software keyboard is displayed on the left side of the screen.
Software keyboard input area will be invalid. |
| (2) Touch the [↑], [↓], [←], [→] keys to move the cursor to an arbitrary position. | ➔ | The cursor for tool compensation amount is moved. |
| (3) Touch the data setting key and enter the value.
Example: 15 | ➔ | "15" is displayed in the software keyboard input area. |
| (4) Touch the [INPUT] key. | ➔ | "15" is input at the tool compensation amount cursor position. |

Note

- (1) It is possible to make an operation input in the entry field of the software keyboard. For details on settings and operations, refer to "2.6.2 Inputting Operations".
- (2) If 20 or more characters are entered in the entry field of the software keyboard, character strings displayed in the input area are scrolled in sequence.
- (3) If you touch the [←] or [→] key while the input area of the software keyboard is enabled, the cursor will move in the relevant direction in the entry field.

Entering data when the input area is disabled

If software keyboard is displayed while edit window is displayed for program editing or input area is not displayed on a screen, or when the monitor screen main menu is displayed, software keyboard input area will be invalid. At this time, the key selected on the software keyboard is directly input to the screen.

- | | | |
|--|---|--|
| (1) Display the edit window on the monitor screen and touch the [S/W Key] button. | ➔ | Software keyboard is displayed.
Software keyboard input area will be invalid. |
| (2) Touch the [↑], [↓], [←], [→] keys to move the cursor to an arbitrary position. | ➔ | The cursor for the edit window is moved. |
| (3) Touch the data setting key and enter the value.
Example: G28 | ➔ | "G28" is displayed in the edit window. |
| (4) Touch the [INPUT] key. | ➔ | "G28" which has been input in the edit window is confirmed. |

2.9.3 Operating the Screen by Touch Gestures

The screen can also be operated by touch gestures.

(1) Changing the menu display (Right-/left-flick)

If you flick the menu horizontally (quickly run your fingertip horizontally along the screen), the menu changes to the previous or next menu.

(2) Scrolling the displayed data (Up/down flick, drag)

If you flick the screen vertically (quickly run your fingertip across the screen) to edit a program or process various table data items such as the compensation amount and common variable, or you drag the screen (touch the surface and move your finger without up and down losing contact), the displayed data is scrolled.

(3) Enlarging or reducing, moving, and rotating a 3D check shape (Pinch-in, pinch-out, drag)

If you pinch in (a gesture to pinch a target between the thumb and index finger on the screen) a machining shape for 3D check, it is reduced. If you pinch out (a gesture to spread the thumb and index finger on the screen) a machining shape, it is enlarged. Also, if you drag the screen, you can move or rotate a machining shape.

(4) Changing a page (Right- or left-flick)

If you flick a page horizontally (quickly run your fingertip horizontally along the screen) to display the workpiece coordinate system offset or guidances such as the alarm and parameter guidances, the page changes to the right or left page.

(5) Displaying the next axis/next part system with right- or left-flick

If you flick (quickly run your fingertip horizontally along the screen) horizontally on the parameter screen, etc., the axis or part system to be displayed can be switched.

(6) Selecting or determining a file (Double-tap)

If you double-tap a target file on the file list screen, operations such as "Search execution", "Open file", and "Erase file" can be performed in the same way as when the [INPUT] key is pressed. However, the value of the input section is ignored.

(7) Moving the window (Flick/Drag)

If you flick (quickly run your fingertip horizontally and vertically along the screen) or drag the title bar on the window display screen such as search screen, the window can be moved to the arbitrary position.

(8) Displaying the guidance by holding down (Long press)

If you hold down the parameter data area (tap the target and keep your finger touched for a while), the guidance of that parameter is displayed.

(9) Displaying edit/selective display window (Double-tap)

If you double-tap the buffer display area on the operation screen, the program being searched is displayed on the edit window. Also, if you double-tap the selective display area, the window which you can operate the menu assigning to the selective display.

[Gesture operation enabled judgment]

When you move your fingertip from the gesture-enabled range to the outside while keeping your finger touching the screen, the gesture operation is enabled until you take your finger off the screen. If you first touch the outside of the gesture-enabled range, the gesture operation is disabled until you take your finger off the screen, even when you move your fingertip in the gesture-enabled area.

Changing the menu display

If you flick the menu horizontally (quickly run your fingertip horizontally along the screen), the menu slides, and changes to the previous or next menu.

(Example)

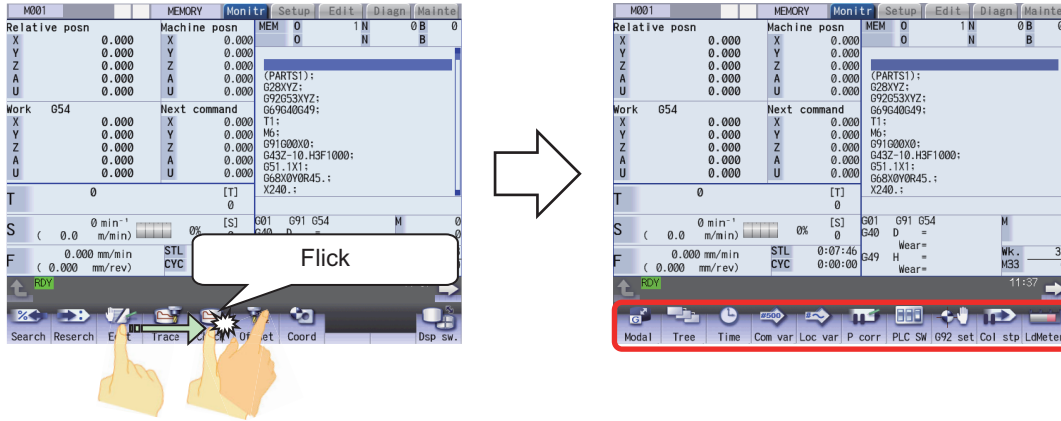

Scrolling the displayed data

If you flick the screen vertically (quickly run your fingertip across the screen) to edit the operation, setup, or editing program or process various table data items such as the compensation amount and common variable, or you drag the screen vertically (touch the surface and move your finger vertically without losing contact), the displayed data is scrolled.

(Example) Scroll by vertical flick

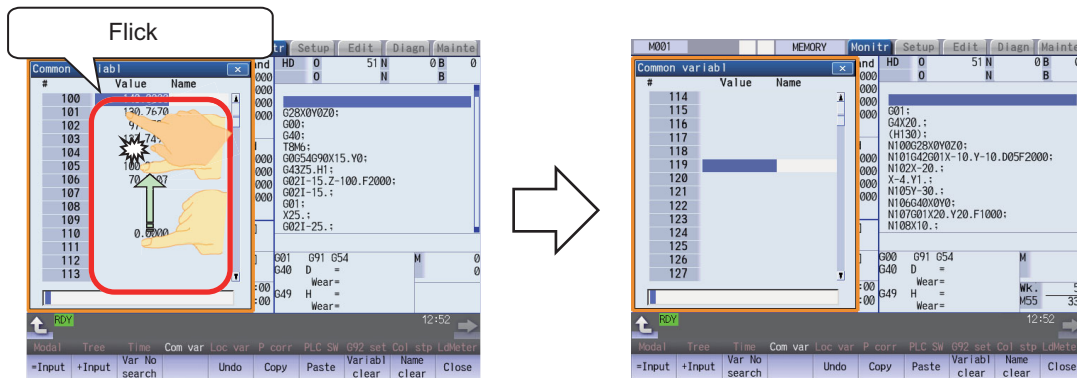

(Example) Scroll by vertical drag

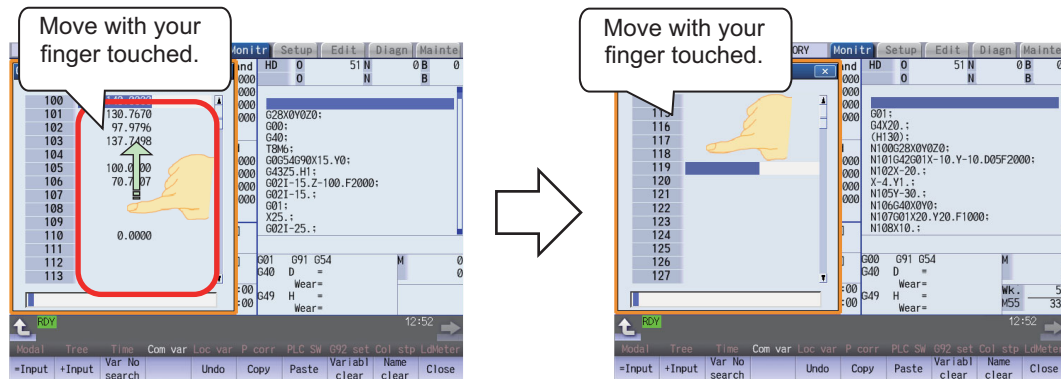

Enlarging or reducing, moving, and rotating a 3D check shape

If you pinch in (a gesture to pinch a target between the thumb and index finger on the screen) a machining shape for 3D check, it is reduced. If you pinch out (a gesture to spread the thumb and index finger on the screen) a machining shape, it is enlarged. Also, you can move or rotate a machining shape by drag operation (touch the surface and move your finger vertically/horizontally without losing contact). However, 3D check gesture operations are disabled during check searching or while the tool setting screen or "Work set" screen is being displayed. 3D check gesture operations are enabled while the [S/W Key] is being displayed.

(Example) Zoom-out

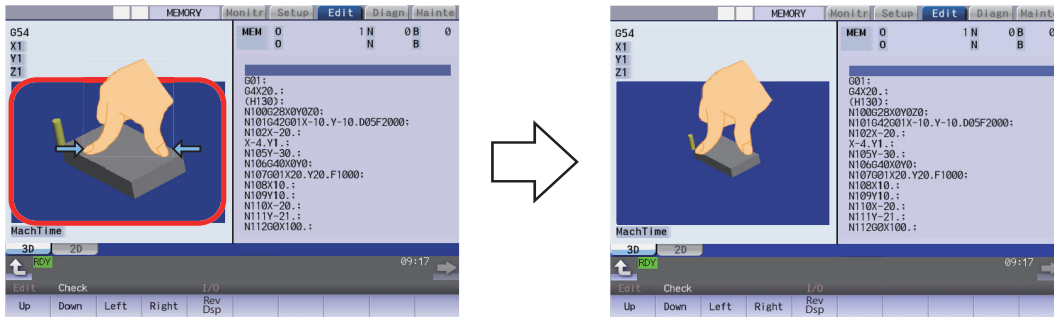

(Example) Zoom-in

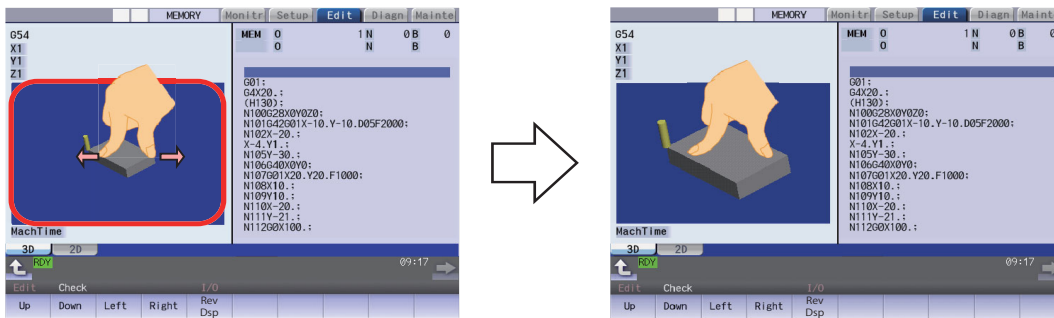

(Example) Move

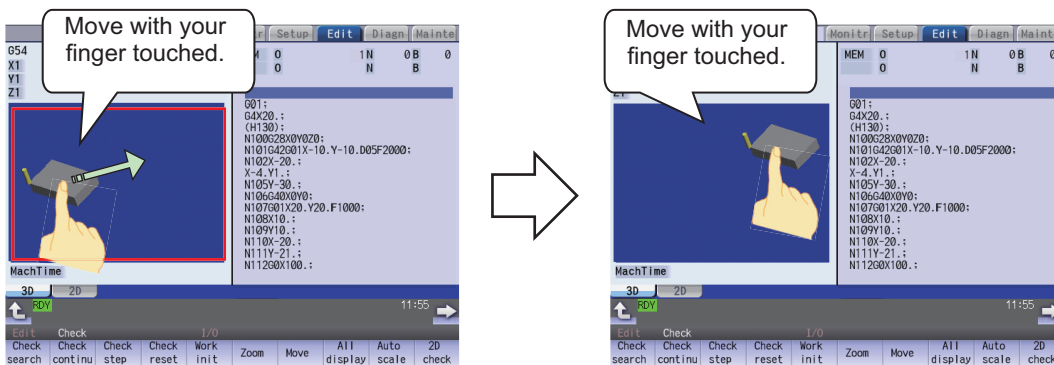

You can rotate a machining shape using a two-finger drag operation (put two of your finger tips on the screen and move them vertically/horizontally without losing contact).

(Example) Rotate about the horizontal axis

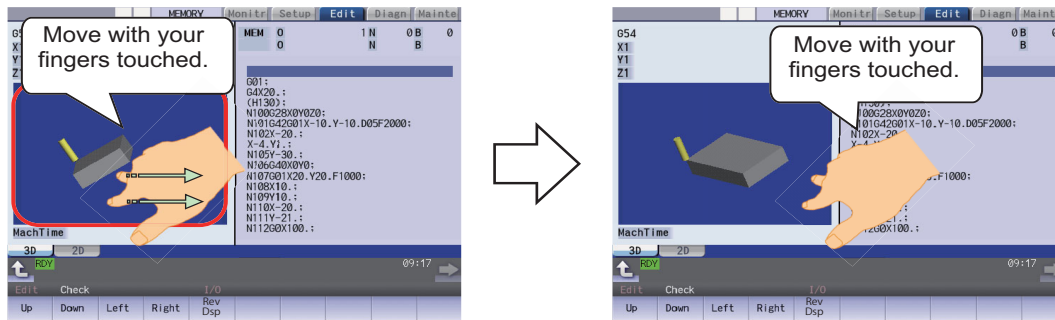

(Example) Rotate about the vertical axis

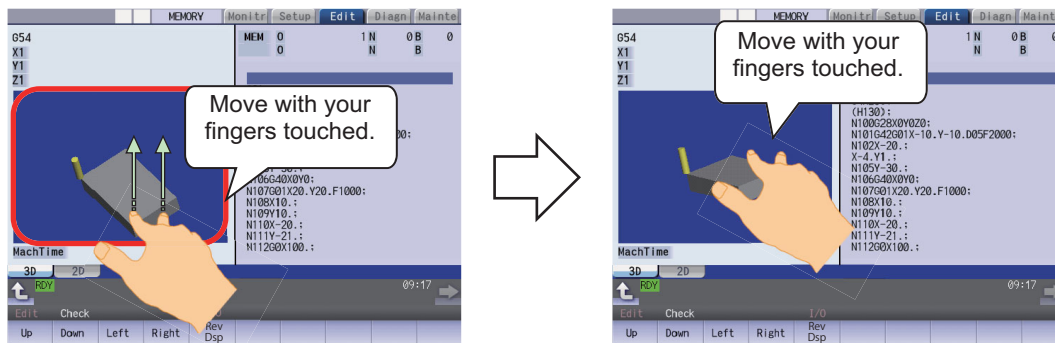

(Example) Rotate about the center coordinate of the material

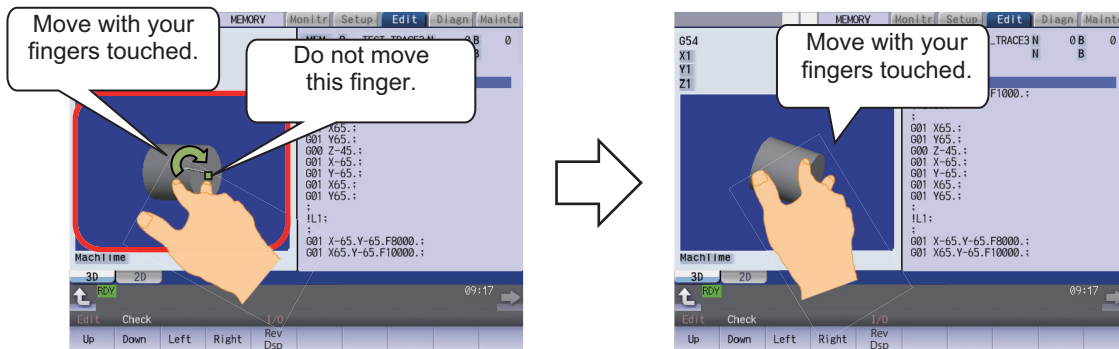

Changing a page

If you flick a page horizontally (quickly run your fingertip along the screen) to display the workpiece coordinate system offset or guidance such as the alarm and parameter guidance, the page changes to the right or left page.

(Example) Page changing for workpiece coordinate system offset

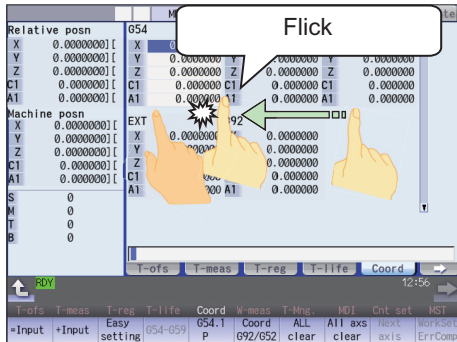

A workpiece coordinate system offset (G54-G56) is being displayed.

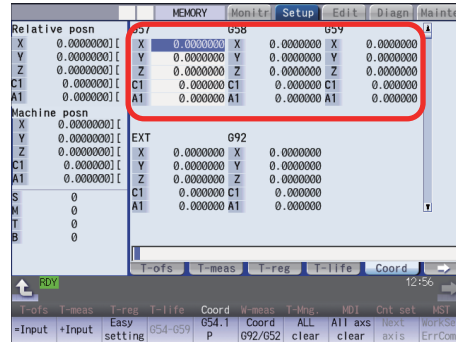

Changed to the next workpiece coordinate system offset (G57-G59) page.

(Example) Page changing for parameter guidance

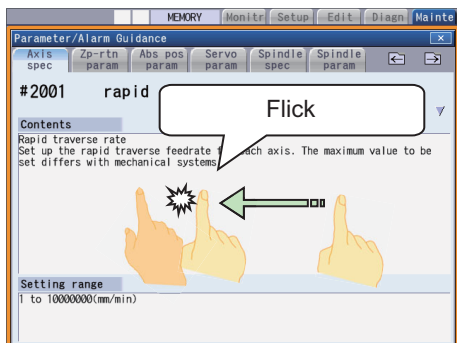

A parameter guidance (#2001) is being displayed.

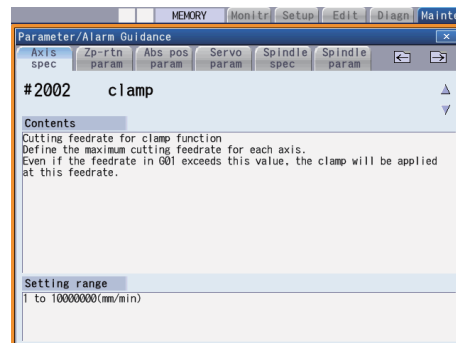

Changed to the next guidance (#2002) page.

Switching axis or part system

On the screen where you can switch the axes being displayed with the menu [Next axis] such as the axis parameter screen, flick (quickly run your fingertip across the screen) horizontally to switch an axis or a part system to be displayed.

(Example) Displaying the next axis of the axes' parameters.

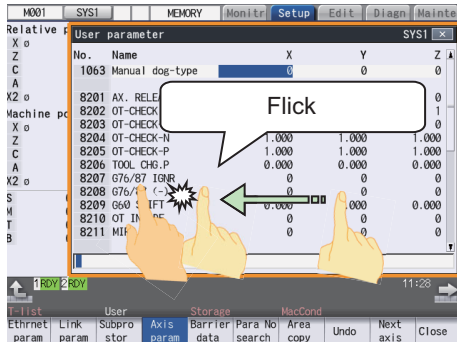

The axis parameters (X, Y and Z axes) are displayed.

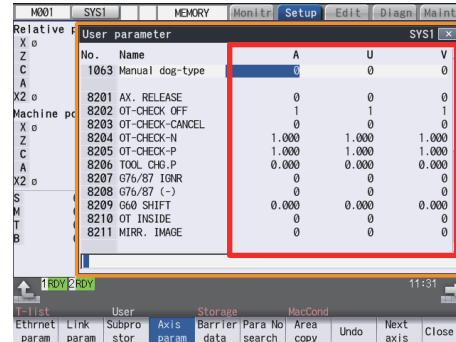

The next axes (A, U and V axes) are displayed.

Selecting or determining a file

If you double-tap a target file on a screen that displays a file list, for example, on the Operate search screen, operation is performed in the same way as when the [INPUT] key is pressed.

(Example) Double-tap on [Monitr] - [Search]

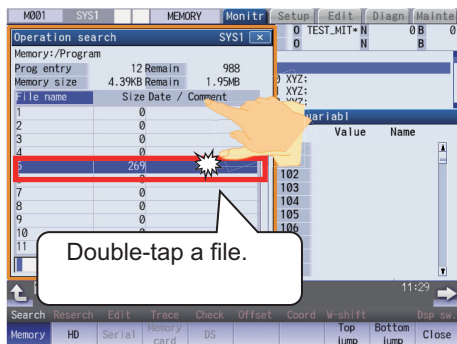

The Search screen is being displayed.

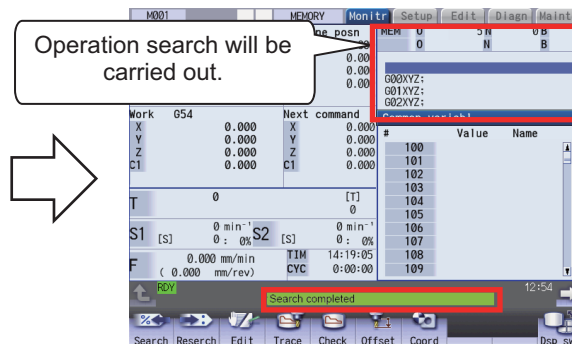

Search is executed.

Note

- (1) The subsequent operation varies depending on the target you double-tapped.
 - When the target is a file: The selected file name is specified.
 - When the target is a folder: The list of files in the selected folder is displayed.

Moving the window by flick/drag

If you flick or drag the title bar on the window display screen such as search screen, the window can be moved to the arbitrary position. The window is not moved during file searching, etc.

The window display position after move is maintained until the power is turned ON again.

(Example) Window movement on [Monitr] - [Search] screen (Drag)

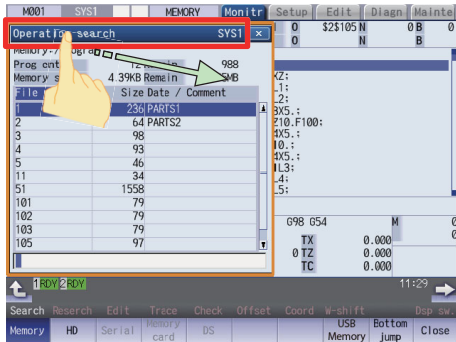

Before window move

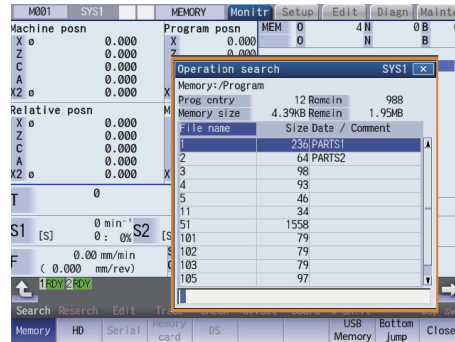

After window move

(Example) Window movement on [Monitr] - [Offset] screen (Flick)

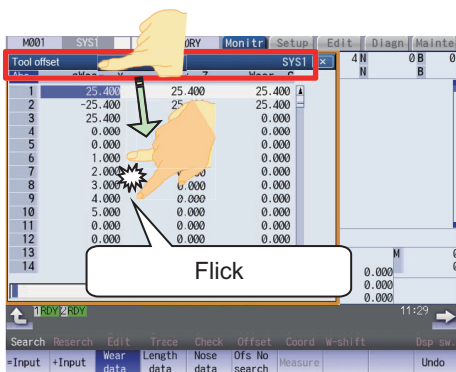

Before window move

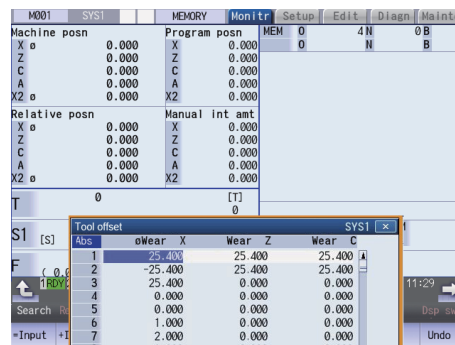

After window move

Displaying the parameter guidance

If you hold down the parameter data area on the parameter screen of the [Setup] or [Mainte] (Maintenance) screen, the guidance of the parameter is displayed.

The length of time which is recognized as a long press can be set with the parameter "#8995 Touchop longtaptim".

(Example) Displaying #8005 guidance

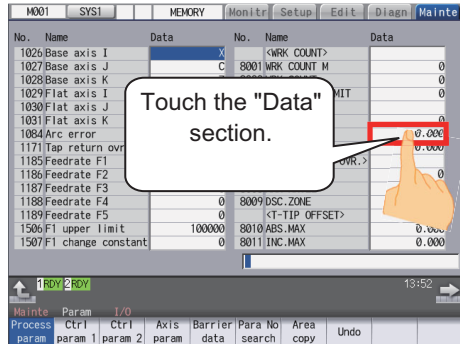

The parameter screen is being displayed (the cursor position is at #1026).

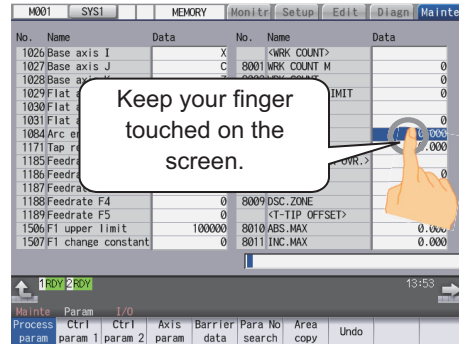

The cursor position moves to #8005.

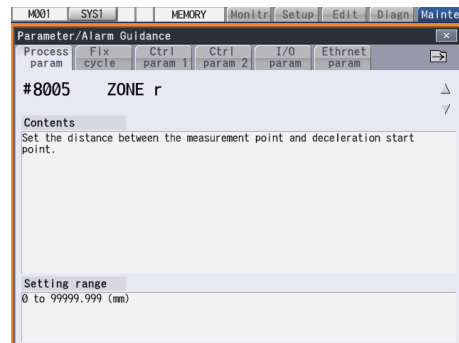

#8005 guidance is displayed.

Note

- (1) Do not remove your finger until the guidance is displayed.

Displaying the alarm guidance

If you hold down the alarm data area on the alarm history screen of the [Diagn] (Diagnosis) screen, the guidance of the alarm is displayed.

The length of time which is recognized as a long press can be set with the parameter "#8995 Touchop longtaptim".

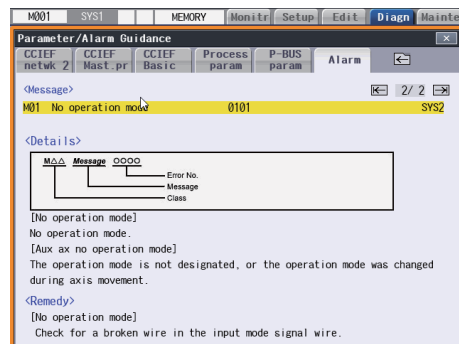
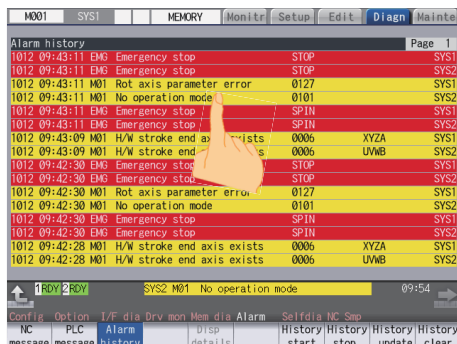

Displaying the edit/selective display window by double-tapping

If you double-tap the buffer display area on the operation screen, the program being searched is displayed on the edit window. You can double-tap the buffer display area for each part system during 2-part system/3-part system simultaneous display.

Also, if you double-tap the selective display area, the window which you can operate the menu assigning to the selective display, in the same manner when you press [INPUT] key.

(Example) Displaying the edit window by double-tapping the buffer display area

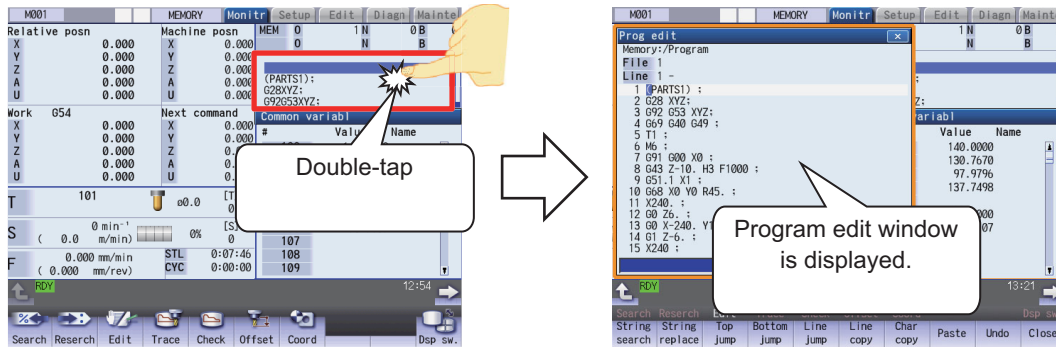

(Example) Displaying the window by double-tapping the selective display area

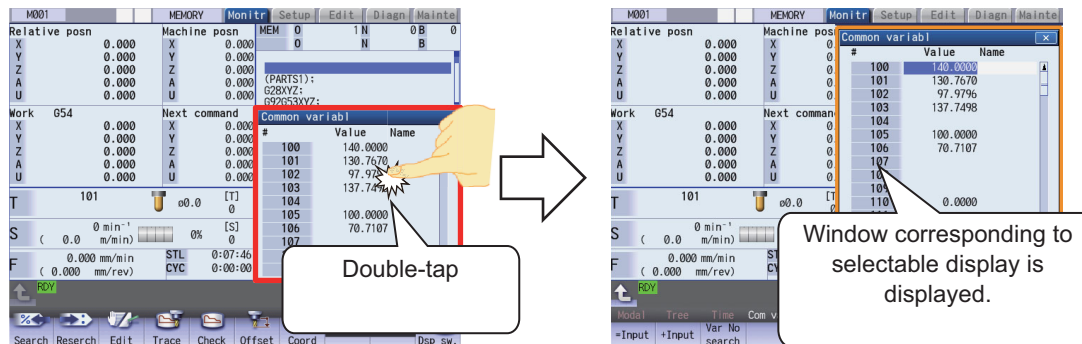

2.10 Menu Customization Function

You can freely relocate the main menus of the monitor (Monitr), setup (Setup) and edit (Edit) screens. This function enables to place the often-used keys in the first page. It can be used when a parameter "#11032 Menu sel para lkof" (Validate menu selection parameter setting) is set to "2". MTB password is required when it is set to "1". The main menu of monitor screen, setup screen and edit screen correspond to the following parameters:

<Menu selection parameter>

Main menu for monitor screen: "#10501 Monitr main menu 1" to "#10530 Monitr main menu 30"

Main menu for setup screen: "#10551 Setup main menu 1" to "#10580 Setup main menu 30"

Main menu for edit screen: "#10601 Edit main menu 1" to "#10630 Edit main menu 30"

Refer to "Alarm/Parameter Manual" for details.

Setting example

Main menu for monitor screen is changed as follows.

The figure below is the default layout.

<Default layout>

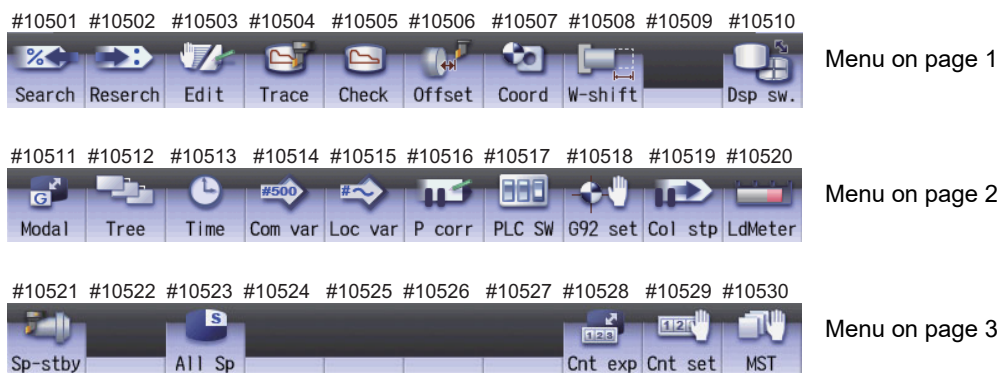

(1) Set the parameters "#10501 Monitr main menu 1" to "#10530 Monitr main menu 30" as shown in the right.

<Parameter>	<After>
#10501	3 (Edit)
#10503	1 (Search)
#10506	11 (Modal)
#10510	1 (Not display)
#10513	7 (Coord)
#10519	-1 (Not display)
#10525	3 (Edit)
#10527	16 (P corr)

Set "0" to the parameters other than the listed above.

(2) Turn the power ON again

The new layout of the monitor screen's main menu is displayed.

<After parameter change>

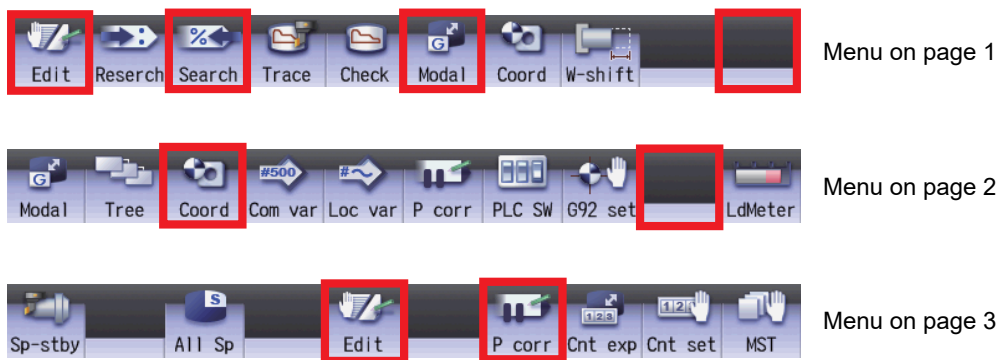

Precautions

- (1) When you set the number which the main menu is not allocated with the menu selection parameter, the menu is not displayed. Menu which is set with other menu non-display parameter ("#8923 Hide Edit-IO menu", "#8932 Hide measure scrn") is also not displayed even if it is set with the menu selection parameter.
- (2) A menu selection parameter setting will be reflected to the menu list.
- (3) Menus which are allocated to the short cut key (it is enabled after the axis address is input), such as [Counter Set] and [MST], become valid by pressing a short-cut key even if they are set as "Not display".
- (4) When the parameter "#11032 Menu sel para lkof" (Menu select param setting enabled) is set to "0", the menu [Menu select] is not displayed.
- (5) When the parameter "#11032 Menu sel para lkof (Menu select param setting enabled)" is set to "1" and the MTB password is not entered, the menu [Menu select] appears, but the menu select param setting screen does not appear even if you press the menu.

2.11 Changing the Operation Level (Protect Setting Screen)



Operating the maintenance screen reduces a phenomenon in which defective workpieces run out due to an operation mistake, by implementing a restriction with seven operation levels. The operation level varies depending on the MTB specifications. Refer to the instruction manual issued by the MTB for details.

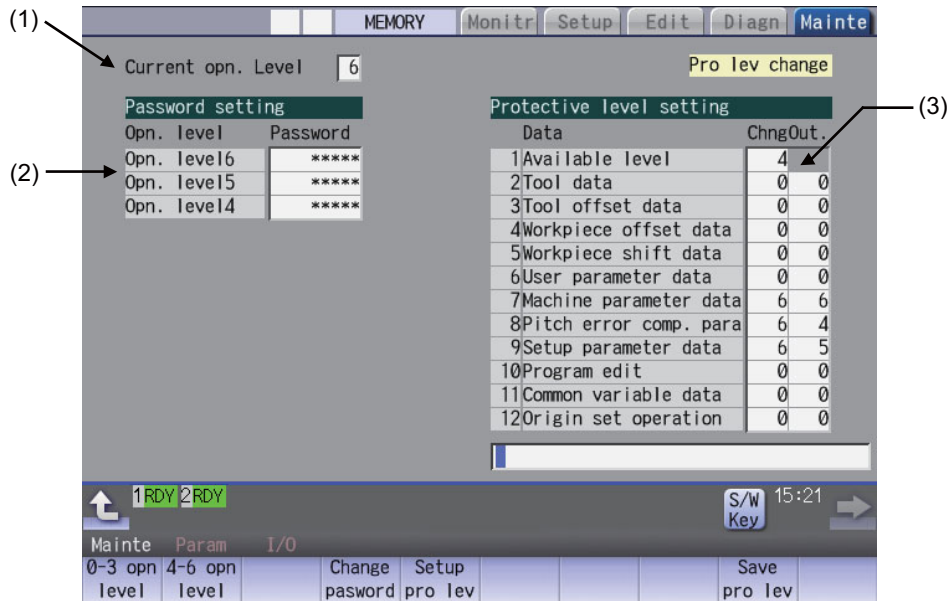

Display items

Display items	Details
(1) Current operation level	Displays the current operation level.
(2) Passwords at operation levels 4 to 6	Displays the passwords of operation levels 4 to 6 with "*****".
(3) Protection level of each data item	Displays the protection level of each data item. The data set below the current operation level can be changed as needed. Changing the protection level displays the message "Pro lev change" at the upper right. Change: Specify the protection level to change data (including a case to input a file). Output: Specify the protection level to output a file.

2.12 Assigning Arbitrary Character String to a User-defined Key

To use this function, define the registration number of the user-defined key and any character string, which is input when the user-defined key is pressed, in the configuration file (KEYDEF.TXT), then place the configuration file in the "M01:\MSYS\CUSTOM" folder.

There are two definition types of user-defined keys: type 1 and type 2. Specify the desired type with the parameter "#8956 User key type".

For information on the correspondence between the assignable user-defined keys and registration numbers, refer to "Key correspondence table" shown below.

[Definition format]

n[character string] (n: Indicates a registration number between "0" and "7".

Key correspondence table

n	Key input
0	U1
1	U2
2	U3
3	U4
4	U5(SHIFT + U1)
5	U6(SHIFT + U2)
6	U7(SHIFT + U3)
7	U8(SHIFT + U4)

[Position of user-defined keys]

FCU8-KB047

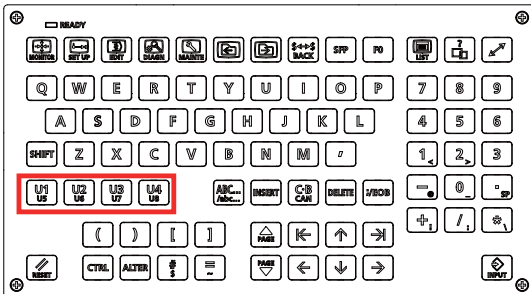

FCU8-KB083

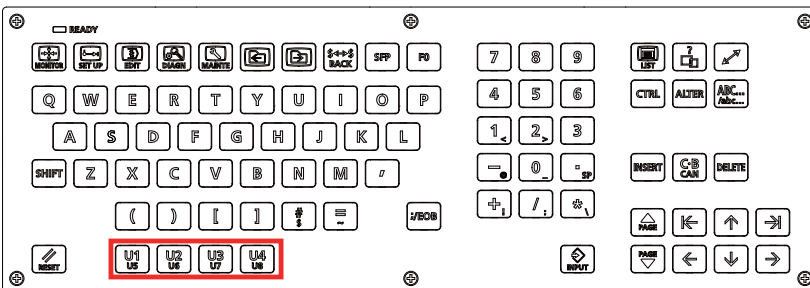

Precautions

- (1) Always input registration number "n" at the head of a row.
- (2) Only the character string enclosed in brackets [] is to be defined.
- (3) If no configuration file is defined, no registration number is assigned to a user-defined key, or if a description is illegal, the default operation is performed as shown in the correspondence table above.

2.12.1 Format of Configuration File

This section describes the format of the configuration file (KEYDEF.TXT) using a type 1 description example.

(Configuration file description example)

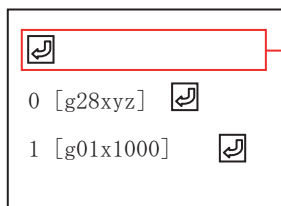

Leaves a 1-row space.

(Supplement)



indicates a linefeed, and LF or CR LF is assumed to be a linefeed.

- (1) Insert a row of only a linefeed at the top of KEYDEF.TXT.
- (2) Describe a definition of each key in the second row and after. In this case,
 - ♦"0" means that character string "g28xyz" is defined as the operation of the "U1" key.
As the actual operation, pressing the "U1" key inputs character string "G28 XYZ".
 - ♦"1" means that character string "g01x1000" is defined as the operation of the "U2" key.
As the actual operation, pressing the "U2" key inputs character string "G01X1000".

Precautions

- (1) When a row is prefixed by a number other than "0" or "7", it is assumed to be a comment line.
- (2) The keys to be defined in the configuration file can be described in no particular order. If necessary, No. 7 can be first described.
- (3) The range enclosed in brackets [] is assumed to be a definition. Characters following the right bracket "]" are assumed to be a comment.
- (4) Only ASCII characters are available, excluding two-byte characters or Chinese characters.
- (5) To describe a definition in the configuration file, be sure to leave a one-row space at the top. This is because the first row is not displayed by a parameter setting when the configuration file is opened on the edit screen.
- (6) Describe only the keys to be defined.
- (7) If you press another key while the defined characters are being output, it causes the defined-key output to be ended.
- (8) When different defined-character strings are assigned to the same key in the file, the last assigned character string is input.
- (9) When a key combined with the "ALTER" key is input (e.g. "ALTER + SHIFT + U1"), it functions as the user-defined key "SHIFT + U1", and the "ALTER" key is ignored.
- (10) When a key with both the "CTRL" and "SHIFT" keys combined is specified (e.g. "CTRL + SHIFT + U1"), it functions as the user-defined key "SHIFT + U1", and the "CTRL" key is ignored.
- (11) A character "A" to "B" at the head of a row can be defined in either uppercase or lowercase characters.

2.12.2 Definition Types of User-defined Keys

The user-defined keys are classified into two definition types: type 1 and type 2, which provide different operations as shown below.

	Type 1	Type 2
Linefeed in brackets []	Not handled as a semicolon ";".	Handled as a semicolon ";".
Dependence of the Caps Lock key	The defined characters are converted to uppercase or lowercase characters depending on the status of the Caps Lock key before they are input.	Characters are input as defined regardless of the status of the Caps Lock key.
Conversion of symbol characters	Symbol characters are converted to specific ones.	No symbol characters are converted.

2.12.2.1 Type 1

Linefeed in brackets []

In the configuration file, a character string to be defined is described in the range enclosed in brackets []. However, if a linefeed is included within the brackets, it causes a format error that assumes that no definition is described for that key.

(Example) Contents of KEYDEF.TXT

```

[ ]
0[1 [ ]
2] [ ]
1[7¥ [ ]
8] [ ]
    
```

(Supplement)

- [] indicates a linefeed, and LF or CR LF is assumed to be a linefeed.

With the configuration file above registered, the following characters are input when the "U1" and "U2" keys are pressed.

Key input	Characters to be input	Supplement
U1	None	No characters are input because the format of the configuration file is invalid.
U2	78	If a linefeed is inserted in a row that includes symbol "\" at the end, it is assumed that the row is continued to the next file.

Handling the Caps Lock key

Characters are input in accordance with the status of the Caps Lock key.

Status of the Caps Lock key	Definition in uppercase characters	Definition in lowercase characters
ON	Lowercase characters are input.	Uppercase characters are input.
OFF	Uppercase characters are input.	Lowercase characters are input.

Note

(1) In NC, the Caps Lock key is set ON when the power is turned on.

(Example) Contents of KEYDEF.TXT

```

[ ]
0[ABCdef] [ ]
1[123xYz] [ ]
    
```

(Supplement)

- [] indicates a linefeed, and LF or CR LF is assumed to be a linefeed.

Input characters with the "U1" and "U2" keys input

Key input	At Caps Lock ON	At Caps Lock OFF
U1	abcDEF	ABCdef
U2	123xYz	123xYz

Conversion of defined characters

There is a case in which the defined-characters described in the range enclosed in brackets [] are converted and input. When symbol "\" is described, the input characters (behavior) vary depending on the succeeding characters. The following shows the correspondence between the defined characters and input characters (behavior).

Defined character		Input character (behavior)	
(Alphabetical characters)		(The defined characters are input in uppercase or lowercase characters depending on the status of the Caps Lock key.)	
(Digits)		(Digits are input as defined.)	
\]]	Right bracket
		(If a linefeed is inserted in a row that includes symbol "\" at the end, it is assumed that the row is continued to the next file.)	
\t		The [→] key (tab key) is input.)	
\n		(The [INPUT] key is input.)	
\@		@	At mark
\[[Left bracket
\	Back slash	(No data is input. Symbol "\" other than the above is ignored.)	
!	Exclamation	!	Exclamation
"	Double quotation	*	Asterisk
#	Sharp	#	Sharp
\$	Dollar	\$	Dollar
%	Percent	%	Percent
&	Ampersand	'	Single quotation
'	Single quotation	:	Colon
(Left parenthesis)	Right parenthesis
)	Right parenthesis	(No data is input.)	
=	Equal	^	Hat
~	Tilde	(No data is input.)	
	Pipeline	}	Right brace
`	Backquote	(No data is input.)	
{	Left brace	`	Backquote
}	Right brace	{	Left brace
+	Plus	~	Tilde
*	Asterisk	(Left parenthesis
<	Left angle bracket	<	Left angle bracket
>	Right angle bracket	>	Right angle bracket
?	Question mark	?	Question mark
_	Underscore	=	Equal
-	Hyphen	-	Hyphen
^	Hat	&	Ampersand
@	At mark	"	Double quotation
[Left bracket	(Not available)	
]	Right bracket	(Specified at the end of a definition.)	
;	Semicolon	;	Semicolon
:	Colon	+	Plus
,	Comma	,	Comma
.	Period	.	Period
/	Slash	/	Slash

2.12.2.2 Type 2

Linefeed in brackets []

In the configuration file, a character string to be defined is described in the range enclosed in brackets []. However, if a linefeed is included in this range, it is handled as a semicolon ";". This is assumed that a semicolon ";" is defined as one character for linefeed.

(Example) Contents of KEYDEF.TXT

```

0[1
2]
1[7¥
8]
    
```

(Supplement)

-  indicates a linefeed, and LF or CR LF is assumed to be a linefeed.

Input characters with the "U1" and "U2" keys input

Key input	Input characters	Supplement
U1	1;2	A linefeed is handled as a semicolon ";".
U2	7;8	A linefeed is handled as a semicolon ";". This is handled as an independent symbol "\", and ignored.

Handling the Caps Lock key

Characters are input as defined regardless of the status of the Caps Lock key.

```

0[ABCdef]
1[123xYz]
    
```

(Supplement)

-  indicates a linefeed, and LF or CR LF is assumed to be a linefeed.

Input characters with the "U1" and "U2" keys input

Key input	Input characters
U1	ABCdef
U2	123xYz

Conversion of defined characters

The defined-characters described in the range enclosed in brackets [] are input as defined. However, when symbol "\" is described, the input characters (behavior) vary depending on the succeeding characters.

The following shows the correspondence between the defined characters and input characters (behavior).

Defined character		Input character (behavior)	
(Alphabetical characters)		(Characters are input as defined regardless of the status of the Caps Lock key.)	
(Digits)		(Digits are input as defined.)	
\\		\	Back slash
lt		The [→] key (tab key) is input.)	
ln		(The [INPUT] key is input.)	
\[[Left bracket
\]]	Right bracket
\	Back slash	(No data is input. Symbol "\" other than the above is ignored.)	
!	Exclamation	!	Exclamation
"	Double quotation	"	Double quotation
#	Sharp	#	Sharp
\$	Dollar	\$	Dollar
%	Percent	%	Percent
&	Ampersand	&	Ampersand
'	Single quotation	'	Single quotation
(Left parenthesis	(Left parenthesis
)	Right parenthesis)	Right parenthesis
=	Equal	=	Equal
~	Tilde	~	Tilde
	Pipeline		Pipeline
`	Backquote	`	Backquote
{	Left brace	{	Left brace
}	Right brace	}	Right brace
+	Plus	+	Plus
*	Asterisk	*	Asterisk
<	Left angle bracket	<	Left angle bracket
>	Right angle bracket	>	Right angle bracket
?	Question mark	?	Question mark
_	Underscore	_	Underscore
-	Hyphen	-	Hyphen
^	Hat	^	Hat
@	At mark	@	At mark
[Left bracket	(Not available)	
]	Right bracket	(Specified at the end of a definition.)	
;	Semicolon	;	Semicolon
:	Colon	:	Colon
,	Comma	,	Comma
.	Period	.	Period
/	Slash	/	Slash

2.12.3 Editing a Configuration File

On the edit screen, you can edit the configuration file (KEYDEF.TXT) in "M01:\MSYS\CUSTOM". The edited data is enabled when the power is turned on again.



(1) Press the menu [Open].



The list appears as a pop-up window.

(2) Input "KEYDEF.TXT".



"KEYDEF.TXT" is displayed in the input field of the list.

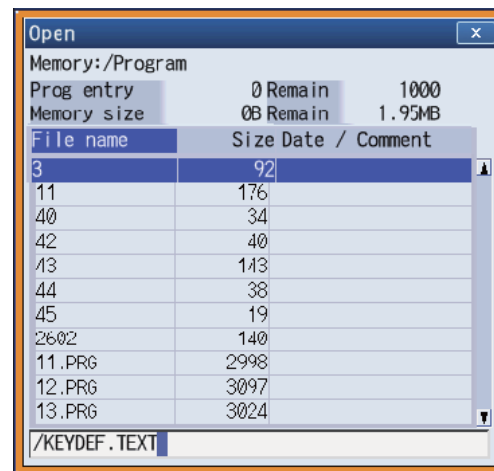

(3) Press the [INPUT] key.



The configuration file (KEYDEF.TXT) is displayed. Edit the file.

Note

(1) To input or output the configuration file, enter "/MSYS/CUSTOM" in the directory on [Mainte] - [I/O] screen.

Restrictions

- (1) Up to eight key types can be registered.
- (2) Up to 256 characters can be described in each definition. If this maximum number is exceeded, the definition is ignored.
- (3) Only the keys on the operation board are available as the types of characters to be registered.
- (4) When the edit screen is in the playback edit mode, the operation message "Can't execute playback edit" is displayed if an attempt is made to perform playback editing.
- (5) When the configuration file (KEYDEF.TXT) is edited on the edit screen, ;(EOB) cannot be replaced.
- (6) When the configuration file (KEYDEF.TXT) is edited on the edit screen, the first row is not read if the parameter "#19006 EOR disable" is set to "0". Therefore, if any characters are defined on the first row, their definition is deleted by an editing operation.
- (7) The configuration file (KEYDEF.TXT) cannot be erased on the edit screen.
- (8) Any user-defined keys are not displayed on the soft keyboard.
- (9) Always open the configuration file (KEYDEF.TXT) in regular editing mode regardless of the setting of the parameter "#8921 Mass Edit select". No editing can be carried out in mass-editing mode.
- (10) On the edit screen, a block is split-displayed in words; however, spaces are not saved even if specified.
- (11) On the edit screen, up to 255 characters can be input to one block, and the 256th character and after are cut to be displayed. If data is saved in this status, the 256th character and after will be cut.
- (12) If the configuration file is not created, or if no defined character string is assigned to a key, no operation is performed when the "U1" to "U8" keys are pressed.

2.13 Outputting the Screen Information (Screenshot Capture Function) (Only for Non-Windows-Based Display Unit)

When the parameter "#8121 Screen Capture" is set to "1" and then [SHIFT] key is kept pressing, the screen information displayed can be output to a USB memory or an SD card as a bitmap format file.

Operation method

- (1) Set the parameter "#8121 Screen Capture" to "1".
- (2) Display the screen to capture.
- (3) Keep pressing the [SHIFT] key on the keyboard for about 3 seconds.  Machine beeps when the [SHIFT] key is pressed. Output of the bitmap file is completed when the machine beeps again after about 3 seconds.
- (4) Reset the parameter "#8121 Screen Capture" to "0".

Bitmap file format

The bitmap file format output by the screenshot capture function is as follows.

Number of colors	Color (256 colors)
Size	308,278 bytes (640 × 480)
File name	A day of the week_Month_Day_Hour_Minute_Second_Year.bmp (Example) When the file is output on "Wednesday, Jan. 23, 2019 at 12:18:38" WED_JAN_23_12_18_38_2019.bmp

Precautions

- (1) Still images can be output with this function.
- (2) The bitmap file cannot be output during cycle start.
- (3) Do not output the bitmap file while any axis is moving by the manual operation mode etc.
- (4) The screen operation cannot be performed while the bitmap file is being output to a USB memory or an SD card. Do not turn the power OFF while a file is being output. The USB memory or SD card may be damaged.
- (5) The bitmap file cannot be output when the memory card is not inserted.
- (6) When there is no empty capacity in the memory card, the bitmap file can be created, however; it is not correctly displayed.

Inputting a Machining Program and Defining Variables

This chapter explains creating and editing the machining program. Generally, operations are performed on the edit (Edit) screen.

Refer to "Programming Manual" for details on G code programming.

3.1 Inputting a Machining Program

When using the program created by external device, input it to NC by using program input/output function. For information on the data input/output function, refer to "5.1 Inputting and Outputting a Program".

3.2 Creating and Editing a Machining Program



Program editing (add, erase, change) can be performed in the NC memory, HD, memory card (front-side SD card), DS (SD card inside the control unit) or USB memory.

This function is used for machining program, MDI program and fixed cycle program.

On the edit screen, editing (add, erase, change or interactive cycle insertion) a machining program and cursor position search can be performed.

There are 4 types of display as shown below:

Multi-program display type	Enables you to edit two programs using each editing area.
G-code guidance display type	Enables you to edit a program referring to the G code guidance.
Playback display type	Enables you to edit a program trying sample machining.
Finish shape display type	Enables you to edit a program confirming the finished shape.

Selected display type is retained after screen transition.

The tab under the editing area is switched depending on the selected display type.

Some tabs may not be displayed depending on the specifications.



For details on switching the display type, refer to "3.6.1 Changing the Display".

You can edit the program on the monitor screen as well. For details, refer to "10.6 Correcting the Machining Program".

Note

- (1) For 3-program/4-program simultaneous editing display on 15-type/19-type display unit, tabs are not displayed. For details on switching the screens, refer to "3.6.1 Changing the Display".
- (2) To display 4-program simultaneous editing display on M800S/M80 Series, the following hardware is required.
 M800S: FCU8-MU542/MA542
 M80: FCU8-MU511/512

For details on how to check your hardware, refer to "11.2.1 System Configuration Screen".

3 Inputting a Machining Program and Defining Variables

There are two types of editing available: regular editing and mass-editing. The specification and the limitation are different between regular editing and mass-editing.

The conditions and the maximum edit size of mass-editing are as follows:

Model	Conditions of mass-editing	Maximum edit size
M800 Series	<ul style="list-style-type: none"> Storage location of the opened machining program is either HD, memory card, USB memory or DS. The size of the file is 1.0MB or more. (Except when the parameter "#8910 Edit undo" is "0", which needs 2.0MB or more.) 	M800S: 20MB M800W (Windows-based display unit): 1GB M800W (non-Windows-based display unit): 20MB
M80W Series	<ul style="list-style-type: none"> Storage location of the opened machining program is either HD, memory card, USB memory or DS. The size of the file is 1.0MB or more. (Except when the parameter "#8910 Edit undo" is "0", which needs 2.0MB or more.) 	Windows-based display unit: 1GB Non-Windows-based display unit: 20MB
M80 Series and E80 Series	<ul style="list-style-type: none"> Storage location of the opened machining program is memory card, USB memory or DS. The size of the file is 0.5MB or more. 	10MB

CAUTION
 The program including a character of any language other than the display language is not correctly displayed. Do not edit such a program. Any part of the program other than the comment part may also be changed if edited.

Multi-program display type

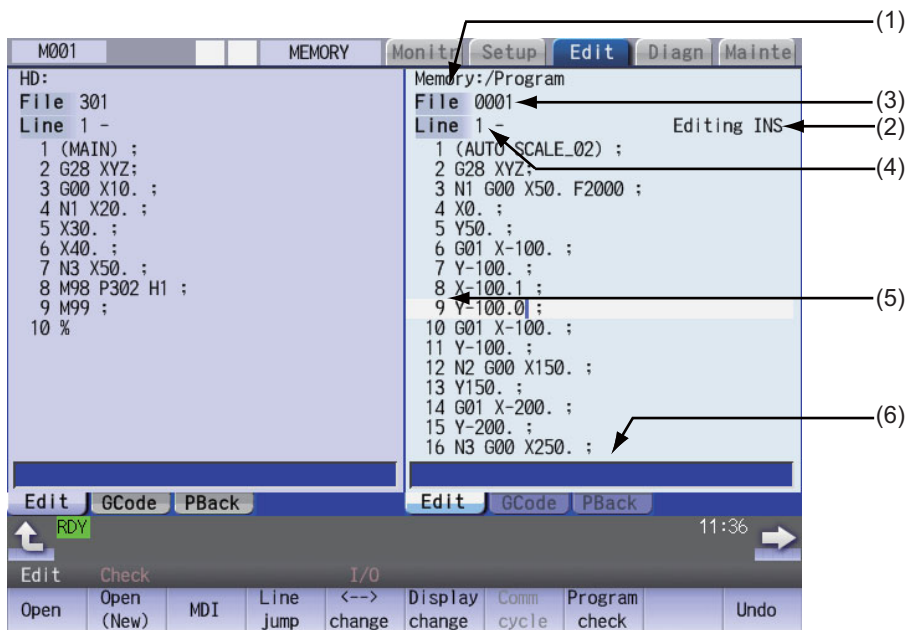

■G-code guidance display type

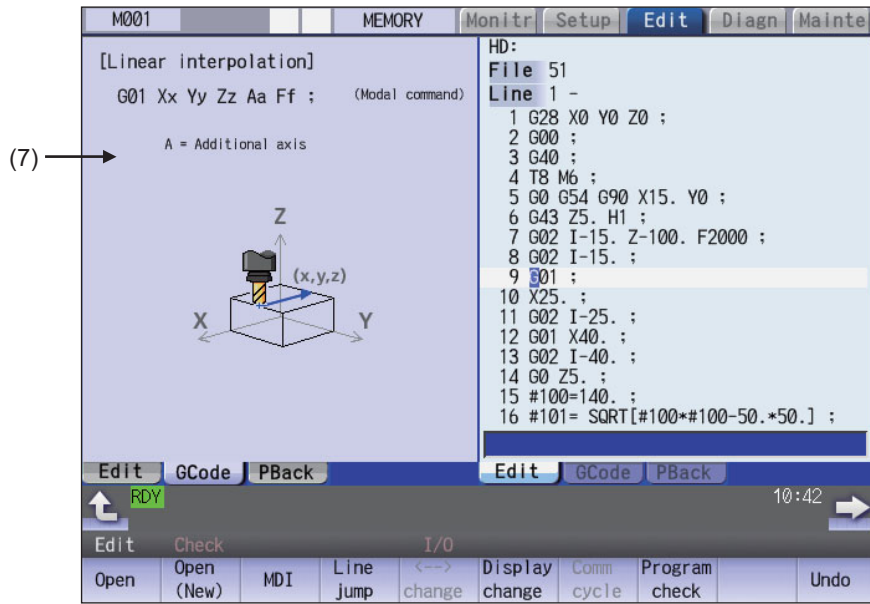

■Playback display type

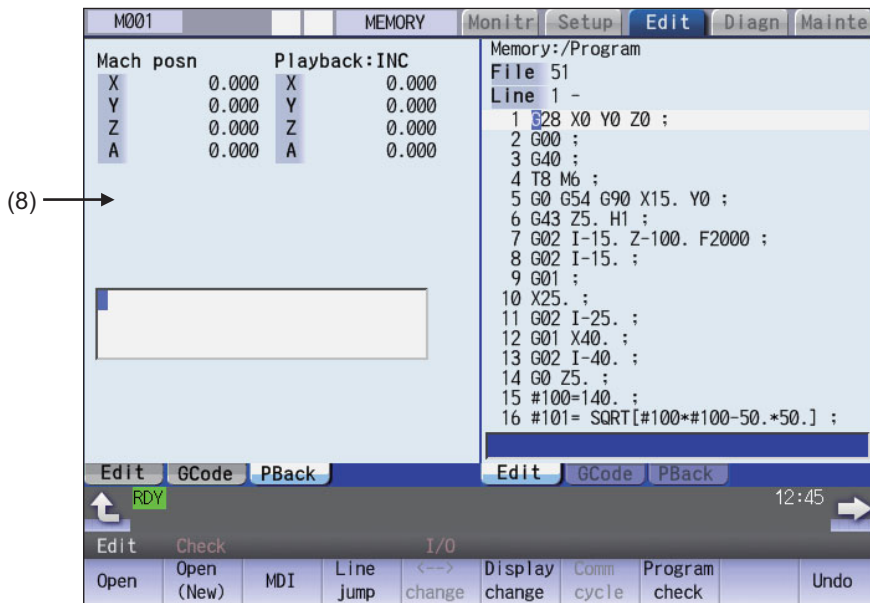

■Finish shape display type

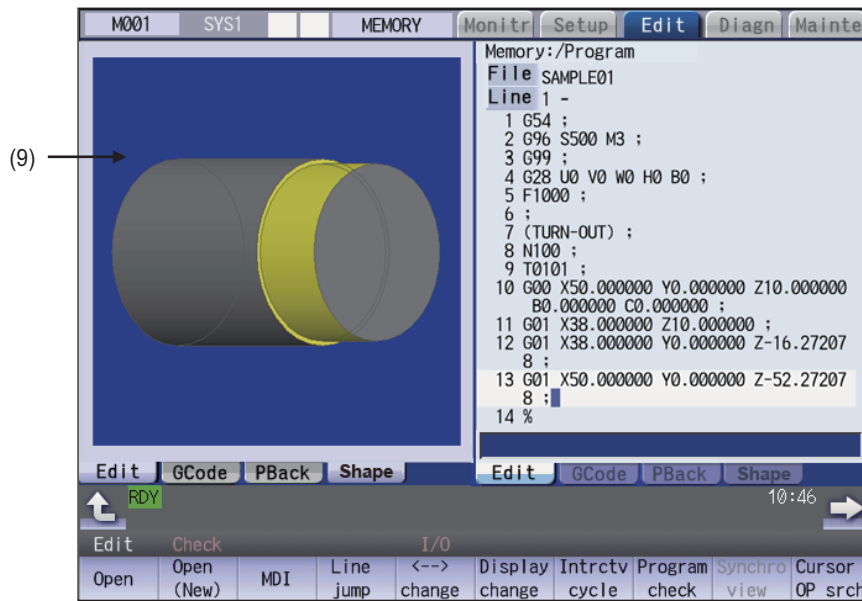

Display items

Display items	Details
(1) Path display	The path of the currently opened program file is displayed. (Example) Memory:/program When the path is too long, the portion exceeding the display area is not displayed.
(2) N No. incremental value display Edit type display Current edit display "Editing" Insert mode display "INS"	<N No. incremental value display> This displays an automatic additional value of sequence No. <Edit type display> This displays "EX" in mass-editing. <Current edit display "Editing"> This displays when performing edit operations after displaying the program. <Insert mode display "INS"> The overwrite mode and insert mode are switched by pressing the [INSERT] key. This is displayed when the insert mode is selected.
(3) Program name display	This displays the file name of the program currently being edited. If the file name exceeds the display area, the last character is ""*". This displays "MDI" when the MDI program name is being edited.
(4) Regular editing: top line of the displayed program Mass-editing: display position	This displays the top line of the displayed program. During mass-editing, the position of the currently displayed page is displayed in percentage (rate) when the entire size of the program is assumed to be 100%.
(5) Line number Program display	<Line number> This displays the last 3 digits of the program line number. When over two or more lines are displayed on the screen because one line is long, the line No. does not attach to the beginning of the next line. The line No. does not attach during mass-editing. <Program display> This displays the contents of the program (machining program, MDI program) currently being edited. The line that the cursor is on is highlighted. The line is not emphasized during mass-editing.
(6) Input section	This inputs the program line number and search character string.
(7) G code guidance display	This displays G code guidance. For details, refer to "2.7.3 G Code Guidance".
(8) Playback display	This displays playback status. For details, refer to "3.7.5 Playback Editing".

Display items	Details
(9) Finished shape display	This displays finished shape status of a machining program. For details, refer to "3.7.6 Displaying the Finished Shape".

Menus

Menus	Details
Open	This edits and references the existing programs. When the program number is designated and the [INPUT] key is pressed, the program contents appear and can be edited.
Open (New)	This creates a new program. When the program number is set and the [INPUT] key is pressed, new comment or program contents can be created.
MDI	This edits the MDI program. When this menu key is pressed, the MDI program appears and can be edited.
Line jump	When the line number is set and the [INPUT] key is pressed, the program data for the set number and later is displayed on the screen. The cursor moves to the set line number.
% jump	With mass-editing, proving an entire program is regarded as 100%, designate the position of the page to be displayed in percentage and press the [INPUT] key. The program data of the designated display position is displayed on the screen. The cursor jumps to the top line of the displayed program.
<--> change	The area that can be edited is switched between the left and right areas. This menu is available for multi-program display type or the multi-part system simultaneous program editing (3 programs).
Display change	The display type (multi-program display, G code guidance display, and playback display) is switched.
Intrctv cycle	This edits the cycle interactively. <Note> <ul style="list-style-type: none"> ♦If the parameter "#8991 Interactive cycle" is "0", this menu is grayed out and non-selectable. ♦If there is no specification of the interactive cycle insertion, this menu is not displayed.
Program check	Program check is carried out for the program displayed in the area that can be edited.
Synchro view	A blank line is inserted so that the timing synchronization symbols (the timing synchronization operations of the machining program) are aligned horizontally. <Note> <ul style="list-style-type: none"> ♦This menu is grayed out and non-selectable in the following cases. <ul style="list-style-type: none"> - When the parameter "#1285 ext21/bit0" (Multi-part system program management) is set to "0" (invalid). - When two or more edit areas do not display the same name programs of different part systems that are stored on NC memory. - When the program numbers displayed in the left and right editing areas are different.
Cursor OP srch	An operation search is carried out for the currently opened program with the block located by the cursor at the top. When the operation search is completed, the display switches to the monitor screen. <Note> <ul style="list-style-type: none"> ♦If the parameter "#1285 ext21/bit0" (Multi-part system program management) is set to "1" (valid), or the program is being edited, this menu is grayed out and non-selectable. ♦If the displayed part system is a sub-part system which does not accept the operation search, this menu is grayed out and non-selectable.
String search	When the character string is designated and the [INPUT] key is pressed, that character string is searched for.
String replace	If the character string to be searched for and the character string to be replaced are separated with a "/" and designated, when the [INPUT] key is pressed, the character string is replaced. This menu cannot be selected during mass-editing.

Menus	Details
Line copy	This copies the designated line (multiple lines can be copied.) This menu cannot be selected during mass-editing.
Char copy	This copies the character string designated by the cursor (multiple lines can be copied.)
Paste	This inserts the most recently copied contents to the line before the cursor or the position before the cursor.
Line clear	This erases the designated line (multiple lines can be erased). This menu cannot be selected during mass-editing.
Miss warning	This enables the input mistake check for the program being edited. This menu cannot be selected during mass-editing.
Next miss	This moves the cursor to the next input mistake warning location. This menu cannot be selected during mass-editing.
Undo	This returns the contents of the program to that prior to saving and display. This menu cannot be selected when parameter "#8910 Edit undo" is set to "0". This menu cannot be selected during mass-editing. <Note> <ul style="list-style-type: none"> When the parameter "#8939 Undo confirm msg" is set to "1", the menu is highlighted while the operation message is displayed.
N auto add	The sequence No. can be added automatically by pressing the [INPUT] key after designating an additional value. This menu cannot be selected during mass-editing.
Display change	This switches the display type.
MDI regist	This registers the MDI program in the memory. This can be performed only when the MDI program is displayed. This menu cannot be selected during mass-editing.
Erase file	This deletes the programs. When the name of the program to be erased is designated, the designated file is deleted.
Display setting	This menu switches the display format of multi-part system simultaneous program editing (2-program/3-program or 2-program/4-program editing). <Note> <ul style="list-style-type: none"> This menu is available for 15-type or 19-type.
PSHAPE	This menu switches to the display of machining shape appropriate to the command which is displayed at the time of machining program input. <Note> <ul style="list-style-type: none"> This menu is displayed only when the additional specification of finish shape view programming is enabled. If the "Shape" tab is not displayed, this menu is grayed out and non-selectable.
Guide M/L	This menu switches G code guidance display (M/L system). The switchable G code system follows the parameter "#11082 Lsys_change_Gtype". <Note> <ul style="list-style-type: none"> This is displayed only when the program format switch specification is valid and the parameter "#1254 set26/bit1" is set to "1". When the G code guidance is not displayed, this menu is grayed out and non-selectable.
Pback next ax	The axis to be displayed in the playback editing is switched from the first to fifth axes and among the sixth and further axes. <Note> <ul style="list-style-type: none"> This menu is enabled if the playback editing (L system) is enabled and the number of axes is 6 or more.
File close	This closes the pop-up window and quits this function.

Menus	Details
Upward Tsearch	These menus search for T code upward or downward.
Down Tsearch	

Sub-menus of [Open]/[Open (New)]/[Erase file] menus

Menus	Details
Memory	This selects NC memory.
HD	This selects the hard disk. This is not displayed on M800S Series, M80 Series, E80 Series, and non-Windows-based display unit of M800W/M80W Series.
Memory card	This selects the front-side SD card.
DS	This selects the built-in SD card.
USB Memory	This selects USB memory.
Top jump	This moves the cursor to the top line.
Bottom jump	This moves the cursor to the last line.
Close	This closes the pop-up window and return to the edit screen.
Comment nondisp	This changes whether to show or hide the comment field. When the comment is hid, the menu is highlighted.
List update	This updates the list contents. (The latest contents of the currently selected device and directory are listed.)
Sort change	This changes the method that the list is sorted.

Sub-menus of [Displaysetting] (For 15-type/19-type)







Menus	Details
2 edit	This switches the display mode to the program simultaneous program edit (2 programs).
3 edit	This switches the display mode to the program simultaneous program edit (3 programs or 4 programs). <Note> ♦You can select either 3 programs or 4 programs with the parameter "#8999 Simul edit - View".
4 edit	

Sub menus of [String search]

When the parameter "#19710 Edit-Upward search" is set to "1", the sub menus are displayed.

Menus	Details
Upward search	This switches the search direction upward.
Down search	This switches the search direction downward.
Quit search	This finishes the string search.









Operation method (Creating a new machining program)

- (1) Press the menu [Open (New)] on the edit screen.
- (2) Select the device.
(Example) Menu [Memory]  The selected device name and directory (memory: /program) appear in the device name and directory display columns.
For the devices other than NC memory, root directory is selected.
The device on the side being edited is displayed first. If a file is not opened, NC memory will be opened.
- (3) (In case of the device other than NC memory.)
Press [↑], [↓], , or  key to move the cursor to the directory with the machining program or the directory to be newly created.
If the list contents differ from the actual device or directory, press the menu [List Update].
- (4) (For the devices other than NC memory)
Press the [INPUT] key.  Moves into the directory.
- (5) Enter the program file name to be newly created.
- (6) Press the [INPUT] key.  When new creation is enabled, an EOR-only program is created.
The list display is closed.
- (7) Edit the machining program.  Refer to "3.6 Editing Operations".
- (8) Press the [INPUT] key.  The edited machining program is saved to the device.

Precautions for creating a new machining program

- (1) If an existing program number is designated, it causes an error.
- (2) The part enclosed in parentheses () in the head block of the program is used as a comment.
- (3) If an existing file is set, the message "Designated file already exists" appears.
- (4) Single-byte digits, single-byte uppercase alphabet characters, and Windows-recognizable single-byte symbols are available for the file name or directory name. Therefore, a double-byte code file name such as a Japanese file name cannot be used.
 Characters which cannot be used: \ / : , * ? " < > | a to z and space
 Also, the followings cannot be treated as file names:
 - File name with extension "\$\$\$", "\$\$0", "\$\$1", "\$\$2", "\$\$3", "\$\$4", "\$\$5", "\$\$6", "\$\$7", "\$\$8", or "\$\$9"
 - "0" (File named "single-byte zero")
- (5) A program, which has a file name consisting of 33 or more characters, cannot be newly created.
- (6) If the parameter "#8936 Delete leading 0" is set to "1" and the file name is designated only by digits, the existing file, edit lock B, and edit lock C are checked by deleting "0" at the head.
 For details, refer to "5.8.6 Leading Zero".

Operation method (editing machining program)

- (1) Press the menu [Open] on the edit screen.
- (2) Select the device.
 (Example) Menu [Memory]  The selected device name and directory (memory: /program) appear in the device name and directory display columns.
 For the devices other than NC memory, root directory is selected.
 The device on the side being edited is displayed first. If a file is not opened, NC memory will be opened.
- (3) (In case of the device other than NC memory.)
 Press [↑], [↓], , or  key to move the cursor to the directory with the machining program or the directory to be newly created.
 If the list contents differ from the actual device or directory, press the menu [List Update].
- (4) (For the devices other than NC memory)
 Press the [INPUT] key.  Moves into the directory.
- (5) Press [↑], [↓], , or  key to move the cursor to the machining program to be edited.
 The name of the machining program to be edited can be input in the input area.
- (6) Press the [INPUT] key.  The program appears at the top if the file can be opened.
 The cursor moves to the head character of the program.
 The mode changes to the overwrite mode.
 (When it is the initial insert mode, "INS" is displayed to the right of the file name and the mode changes to the insert mode.)
 The list display is closed.
- (7) Edit the machining program.  Refer to "3.6 Editing Operations".
- (8) Press the [INPUT] key.  The edited machining program is saved to the device.

Precautions for editing machining program

- (1) An error occurs if a nonexistent program No. is set.
- (2) If the selected program is running or program restarting, it can be displayed but not edited.
An error occurs when the data is set or the [INPUT] key is pressed.
- (3) The fixed cycle program list is displayed when the parameter "#1166 fixpro" is set to "1".
- (4) Editable size differs depending on each device. When the editable size is exceeded, the operation message "Can't edit because of size over" appears.
- (5) "Loading" is displayed in flickering until the file is opened.
- (6) Editing is not possible for a program with 33 or more file name characters.
- (7) When the program in search was edited, the program is searched again as follows depending on the last operation.
 - ♦Search -> Edit: The position in which ONB is displayed is searched again.
 - ♦Search -> Reset 1-> Edit: The program top is searched again.
 - ♦Search -> Reset 2-> Edit: The search is not executed. If a program was added or deleted, the search position may shift.
 - ♦Search -> Reset & Rewind -> Edit: The program top is searched again.
- (8) If an attempt was made to open the currently edited file on the custom screen from this screen, the operation message "Read-only as the file is being edited" may appear.
- (9) If an attempt was made to edit the currently edited file in the custom screen from this screen, the operation message "Read-only file - Can't edit" appears and may not be able to edit.
- (10) If the protection level ("Program edit" data output) designated on the protection setting screen is higher than the current operation level, the machining program cannot be opened (message "data protection" is displayed). However, if the protection level is set to a higher value on the protection setting screen while a machining program remains opened, the machining program is kept opened even after the display has returned to the edit screen. To hide the machining program after changing the protection level, press the menu [Close] to close the machining program, and change the protection level on the protection setting screen. For details, refer to "2.11 Changing the Operation Level (Protect Setting Screen)".
- (11) Display will be changed as follows depending on the value set in the user parameter "#19006 EOR Disable".
 - <When the parameter "#19006 EOR Disable" = "0">
 - ♦When a file including "%" is opened in the edit screen, characters up to "%" will be displayed. By saving the file, characters after "%" will be discarded.
 - ♦When a file not including "%" is opened, "%" will be displayed at the end of the edit screen. By saving the file, "%" will also be saved.
 - ♦When an external device file, other than NC memory, is opened, it will be displayed in the edit file with skipping the first line.
 - <When the parameter "#19006 EOR Disable" = "1">
 - ♦The contents of a file is displayed on the edit screen as it is.
 - ♦When a file whose last character is other than "%" is opened, "%" will be displayed at the end of the edit screen. "%" will be saved by saving the file. For example, if the end of the file is "%" + "CRLF", an extra "%" will be added at the end.
 - ♦When an external device file, other than NC memory, is opened, the first line will not be skipped.
 - ♦"Line copy" and "Line clear" can be made at the lines other than the last line which includes "%".

Opening a machining program by specifying a sequence No.

- (1) Press the menu [Open] on the edit screen.

- (2) Select the device.
(Example) Menu [Memory]  The selected device name and directory (memory: /program) appear in the device name and directory display columns.
The menu [Memory] is highlighted.
For the devices other than NC memory, root directory is selected.
The device on the side being edited is displayed first. If a file is not opened, NC memory will be opened.

- (3) Input "(Machining program name)/(Sequence No.)" in the input section.
(Example) When specifying sequence No. 100 of program 1
1/100

- (4) Press the [INPUT] key.  The program appears from the specified sequence No. if the file can be opened.
The cursor moves to the head character of the sequence No. and the mode changes to the overwrite mode.
(When it is the initial insert mode, "INS" is displayed to the right of the file name and the mode changes to the insert mode.)
The list display is closed.

Note

- (1) When the file does not exist, the message "Designated file does not exist" appears and the file is not opened.
- (2) When the nonexistent sequence No. or the value which cannot be treated as sequence No. is specified, the message "Nonexistent sequence #: display from top" appears and the head of the program is displayed.
Numbers 1 to 99999999 can be treated as sequence No.
- (3) "Loading" is displayed until the file is opened. The message flashes every second.

3.3 Registering and Editing the MDI Program



Operation method for editing MDI program

- | | | |
|--|---|--|
| (1) Press the menu [MDI] on the edit screen. | ➔ | <p>The menu is highlighted.
 The MDI program is displayed from the head of the editing side. The cursor moves to the head character of the program.
 The cursor moves to the head character of the program. The mode changes to the overwrite mode.
 (When it is the initial insert mode, "INS" is displayed to the right of the file name and the mode changes to the insert mode.)</p> |
| (2) Edit the MDI program. | ➔ | Refer to "3.6 Editing Operations". |

Note

- (1) Before starting MDI operation, confirm that the MDI settings are completed. If "Editing" or "MDI no setting" is displayed, the MDI operation cannot be started.
 When the [INPUT] key is pressed, the head block will be searched, and the message "MDI Set ended" will appear. The setting will then be completed.
 If the cursor is moved without editing, the block indicated by the cursor will be searched for when the [INPUT] key is pressed.
- (2) If the [INPUT] key is pressed when the number of MDI program characters including EOB (;) and EOR (%) exceeds 2000, "Memory capacity over" message will appear and the MDI program will not be searched for execution.
 Note that the contents edited after the MDI program is saved last will not be saved in the NC.
- (3) When the parameter "#1288 ext24/bit0" (MDI program clear) is set to "1", the MDI programs are cleared when MDI operation ends, the power is turned ON again, reset is input and emergency stop is canceled, and only % programs are saved.
 - ◆When the parameter "#1285 ext21/bit0" (Multi-part system program management) is set to "1" (valid), the MDI program of the part system in which MDI operation ends or the reset signal issues is cleared.
 - ◆The MDI programs before editing is cleared during the MDI program editing.
 - ◆Reset input refers to NC reset 1, NC reset 2 and reset & rewind.
 - ◆MDI program clear is performed regardless of operation mode.
 - ◆When MDI program is cleared during the character string replacement confirmation waiting or line clear confirmation waiting, the character string replacement or line clear is canceled and each menu highlight returns to normal.
 - ◆When MDI program is cleared after the range of the target block for line copy and line clear has been set, the designated machining program is de-highlighted.

Operation method for registering MDI program

- (1) Press the menu [MDI] on the edit screen.
- (2) Select the program to register, and then press the [INPUT] key.

Note

- (1) The program is registered as a general program of NC memory.
When the fixed cycle or MTB macro is selected with the parameter "#1166 fixpro" (Fixed cycle editing), the program cannot be registered. The "Save not possible" message appears.
- (2) Program cannot be registered while "Editing" is being displayed. The "Save not possible" message appears. Press the [INPUT] key to be "MDI Set ended".
- (3) When the general program remaining capacity is less than the value of MDI program to be registered, the program cannot be registered. The "Memory over" message appears.
- (4) When the number of remaining general programs is zero, the program cannot be registered. The "Program entry over" message appears.
- (5) When the [INPUT] key is pressed without entering the program name, "Setting error" occurs.
- (6) If the program name is input with only numbers when the parameter "#8936 Delete leading 0" is set to "1", the number without the leading zero is registered as the program name. However, when a number without a leading zero is outside the range 1 to 99999999, the leading zero is not deleted.
- (7) If the input program name already exists in the NC memory, the MDI program cannot be registered during the operation, program restart or program checking. The operation message "Executing automatic operation", "Program restarting" or "Program checking" appears.
If the program name is input with only numbers when the parameter "#8936 Delete leading 0" is set to "1", the program is checked with the leading zero deleted. (Example: If the MDI registration is specified as "0001" when the program "1" is in automatic operation, the "Executing automatic operation" message appears and the registration cannot be performed.)
- (8) When the input program name already exists in the NC memory and it is not being in operation, the "Overwrite this file?(Y/N)" message appears. When the [Y] or [INPUT] key is input, the program name is overwritten, and when a key other than those is pressed, the registration is canceled.
If the program name is input with only numbers when the parameter "#8936 Delete leading 0" is set to "1", the program is checked with the leading zero deleted. (Example: If the MDI registration is specified as "0002" when the program "2" already exists in the NC memory and it is not in the operation, the "Overwrite this file?(Y/N)" message appears.)
- (9) When the program name to be input is subject to edit lock (edit lock B: 8000 to 9999, edit lock C: 9000 to 9999), the message "Edit lock B" or "Edit lock C" appears, and the program name cannot be registered.
If the program name is input with only numbers when the parameter "#8936 Delete leading 0" is set to "1", the program is checked with the leading zero deleted. (Example: If the MDI registration is specified as "008000" when the edit lock B is valid, the "Edit lock B" message appears and the program cannot be registered.)
- (10) When the data protection is valid, "Data protect" is displayed and the program cannot be registered in the NC memory.

3.4 Registering and Editing the Fixed Cycle Program

The subprogram for the fixed cycle can be input, output and edited.



CAUTION



Do not change the fixed cycle program without prior approval from the MTB.

Note

- (1) Since the G.1 command is used to perform the movement of a fixed cycle program, do not edit the contents of the program being described before the G.1 command. Do not delete the contents or do not insert any other commands than the G.1 command. If you edit the program in such a manner, the fixed cycle program is not performed properly.
- (2) When a fixed cycle program is executed, the modal information of the dedicated group 01 is used. This intends that the modal of the main program, which calls the fixed cycle program, is not influenced by the fixed cycle program. Therefore, you can edit the fixed cycle program without considering the modal of the main program. In the fixed cycle program, the modal of the group 01 after the G.1 command is "G00".

Refer to "Programming Manual" for details on the fixed cycle program.

3.4.1 Fixed Cycle Operation Parameters

To input/output or edit the data of each fixed cycle subprogram, use the Data I/O and edit screens in the same way as when creating usual user-created work programs. In this case, the parameters must have been set. Set "1" in parameter "#1166 fixpro". If this parameter is valid, the IN/OUT and edit screens are usable only for operating a fixed cycle control subprogram. During this period, program file displays only fixed cycle programs. Thus, after the fixed cycle program operation, return the parameter to "0".

Note

- (1) Parameter "#1166 fixpro" will be set to "0" when the power is turned OFF.







3.4.2 Transmitting and Erasing the Fixed Cycle Program

Transmit/erase the fixed cycle program from the Data I/O screen. Check that fixed the parameter "#1166 fixpro" is valid. The operating procedure is the same as a user machining program.

3.5 Erasing a File



Operation method

- (1) Press the menu [Erase file] on the edit screen.
- (2) Select the device.
(Example) Menu [Memory]  The selected device name and directory (memory: /program) appear in the device name and directory display columns.
For the devices other than NC memory, root directory is selected.
The device on the side being edited is displayed first.
If a file is not opened, NC memory will be opened.
- (3) (In case of the device other than NC memory.)
Press the [↑], [↓], , or  key to move the cursor to the directory with the machining program or the directory to be newly created.
If the list contents differ from the actual device or directory, press the menu [List Update].
- (4) (For the devices other than NC memory)  Moves into the directory.
Press the [INPUT] key.
- (5) Press [↑], [↓], , or  key to move the cursor to the machining program to be edited.
The name of the machining program to be erased can be input in the input area.
- (6) Press the [INPUT] key.
When a name of machining program is inputted in the input area, the confirmation message appears.
- (7) Press the [Y] or [INPUT] key.
Press the [N] key to cancel.

Note

- (1) The file is not erased in the following cases.
 - The file that is to be erased is currently being used in automatic operation.
 - The file that is to be erased is subject to edit lock B or C.
 - Data protection is valid.
 - The file to be erased is in the "program restarting" state.

3.6 Editing Operations



When the program is edited, the key input data is directly written into the program display area. All data is overwritten from the cursor position. "Editing" appears on the right side of the file name display once input is started.

Press the [INPUT] key to save the program to the device and clear the "Editing" message.

The editing operations from when the file is actually opened are explained in this and the following sections. These editing operations are common for the machining program and MDI program.

Note

- (1) The initial mode (overwrite/insert) at start of editing and the [DELETE] key operation (DELETE/BackSpace) can be selected with the parameters. The operation with overwrite mode and DELETE operation is explained in this manual unless otherwise specified.



CAUTION

If there is no value after the G command, the operation will be the "G00" operation when the program is run due to key chattering, etc., during editing.

3.6.1 Changing the Display

Switching the active area

Switching the active area is possible only when the multi-program display type is selected.

Press the [←→ change] key to switch the active area between the left and right window.

Switching the display type

Press the menu [Displaychange] to switch the display type.

The same operation can be performed with the  key.

The display is switched in the order of multi-program display type -> G code guidance display type -> playback display type -> finished shape display type -> multi-program display type...

Note

- (1) Press  to switch in the inverse order.
- (2) Some tabs may not be displayed depending on the specifications. When only the edit tab is displayed, the menu [Displaychange] cannot be selected.

Changing the display using the page up/down keys ( : Previous page,  : Next page)

 key: This displays one page of preceding lines of the current top line.
 When there is less than one page of data, a page of data will be displayed including the data currently displayed.
 The cursor moves to the last line of the screen.

 key: This displays one page of following lines of the current bottom line.
 The cursor moves to the top line of the screen.

Note

(1) The cursor does not move in mass-editing.

Changing the display with the cursor key

The cursor will move up one line in the program each time the cursor key ([↑], [↓]) is pressed.
 If the [↓] key is pressed at the top line of the program display area, the program will scroll up one line. If the [↑] key is pressed at the end, the program will scroll down one line.

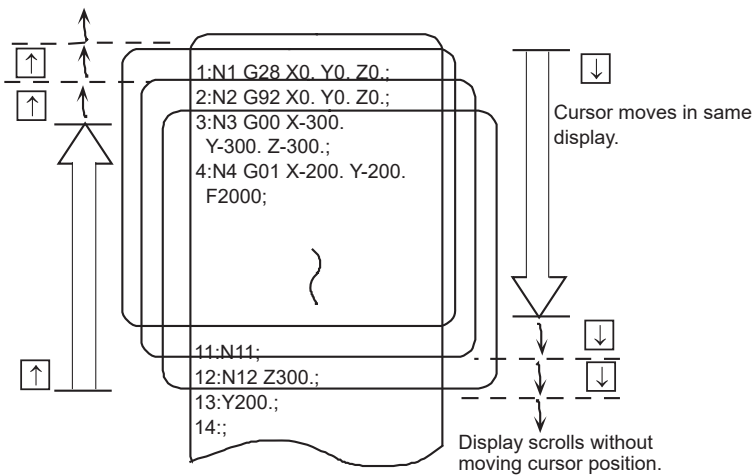

<When a program of one line number extends over multiple lines>

■ For the regular editing

When the parameter "#8990 Edit-up/down keys" is set to "0":
 Press [↑], [↓] keys to move the cursor back and forth on the line number basis.

When the parameter "#8990 Edit-up/down keys" is set to "1":
 Press [↑], [↓] keys to move the cursor to the previous or next line.

■ For mass-editing

Press [↑], [↓] keys to move the cursor to the previous or next line.

Move the cursor using the tab keys ([←]: back tab/ [→]: tab)

[←] key : Moves to the start of the word where the cursor is currently positioned.

If the cursor is at the start of a word, it moves to the start of the previous word.

[→] key : Moves to the word after the word where the cursor is currently positioned.

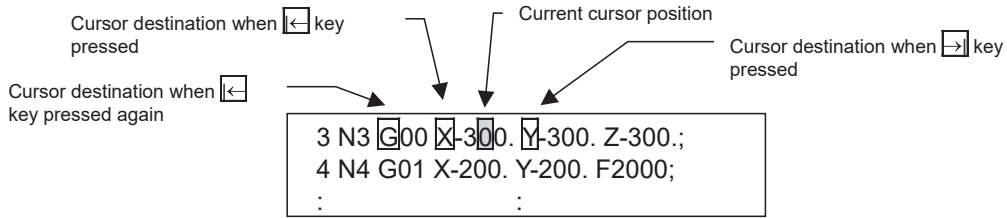

Note

(1) Pressing [←] [→] keys or [←] [→] keys does not make any difference in mass-editing.

Split display by word unit

The program is split by word unit and displayed.

In mass-editing, program is not split by word unit and displayed as text data.

Switching the page by the scroll bar (Mass-editing)

For mass-editing, if you touch the scroll bar, the page is switched or the screen is scrolled by one line.

If you touch [▲] or [▼] of the scroll bar, the screen is scrolled up or down by one line. Also, if you touch the empty portion of the scroll bar, the page is switched to the next page or previous page.

Pages cannot be changed by dragging the slider.

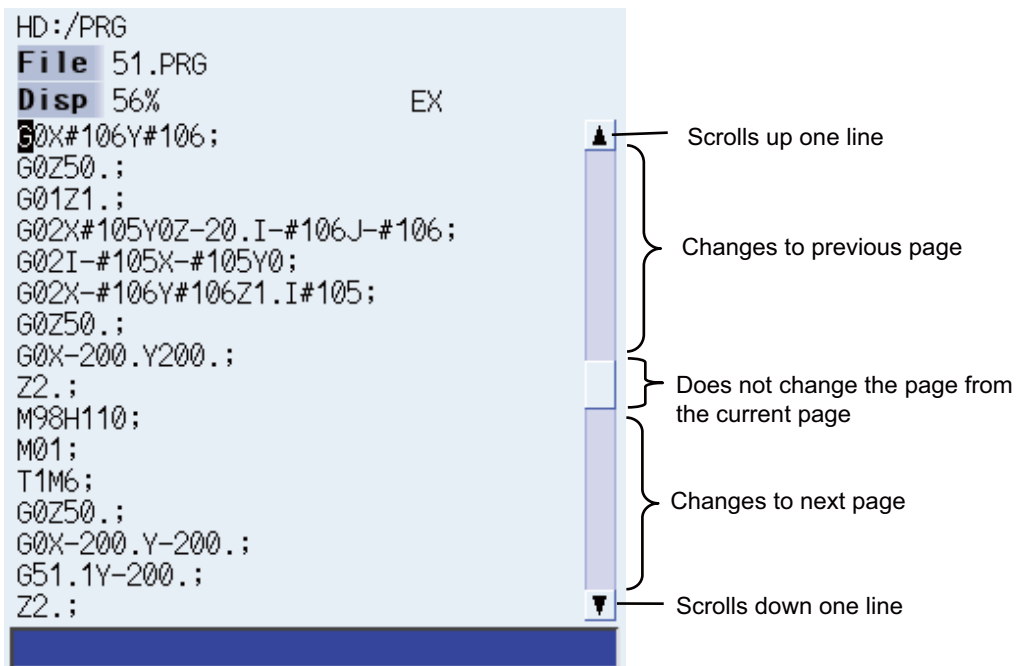

3.6.2 Displaying an Arbitrary Line

Operation method



- (1) Press the menu [Line jump].
- (2) Input the line No.
(Example) 6 [INPUT]  The program appears with the designated line No. at the head.

Note

- (1) When "0" is input, the cursor moves to the first line.
- (2) When "E" is input, the cursor moves to the end.

3.6.3 Rewriting Data



Operation method (Initial data overwrite mode)

- (1) Move the cursor to the position where data is to be inserted.
The cursor can be moved to one place to the right of EOB (;).
- (2) Set the data.  The message "Editing" appears when setting is started. The data is set from the position of the cursor. Data at the area is overwritten. The cursor moves one space (character) at a time to the right as the data is set.
- (3) When the setting is completed, press the [INPUT] key.  EOB (;) is added to the set data and the data is fixed. When newly creating data, the cursor moves to the head of the next line. When changing existing data, the cursor does not move.

Note

- (1) When the cursor is on or one place to the right of EOB (;), input data is inserted even if not in input mode (refer to "3.6.5 Overwriting Data (Initial Data Insertion Mode)".)

Operation method (Initial data insertion mode)



- (1) Move the cursor to the position where data is to be inserted.
The cursor can be moved to one place to the right of EOB (;).
- (2) Set the data.  The message "Editing" appears when setting is started. The data is set from the position of the cursor. The data from the cursor position moves to the right. The cursor moves one space (character) at a time to the right as the data is set.
- (3) When the setting is completed, press the [INPUT] key.  The set data is fixed. The cursor does not move, but if there is no EOB (;) at the end of the line, it will be added. Then, the cursor moves to the next line. The message "Editing" disappears.

Precautions



- (1) When changing to another function such as the program check, or to another screen such as the monitor screen when "Editing" displays, the operation message "Save current file?(Y/N)" displays. If [N] key is pressed changing to the other screen once, and the edit screen is selected again, the program before editing operation will be displayed. (Edited contents will be invalid.)
- (2) When changing to another function such as the program check, or to another screen such as the monitor screen when "Editing" displays, the operation message "Save current file?(Y/N)" displays. If the file could not be saved due to "Memory over", etc., even the [Y] key is pressed, the error message displays and the screen is not changed. The screen display varies depending on the succeeding operation (a) or (b) as follows.
When the file could not be saved and the error message displays due to "Memory over", etc., even the [INPUT] key is pressed before the screen change operation, the screen display also varies depending on the succeeding operation (a) or (b) as follows.
 - (a) When changing to another function such as the program check, or to another screen such as the monitor screen without editing, the screen transition is performed without displaying the operation message. If the display returns to the program edit screen again, the previously saved contents are displayed.
 - (b) When changing to another function such as the program check, or to another screen such as the monitor screen after editing (data setting key operation, data correction key operation, or the menu [Paste], [Line clear] or [String replace] operation), the operation message "Save current file?(Y/N)" is displayed.
- (3) When editing a program that is being checked, the "Checking other programs. Reset?(Y/N)" message is displayed. Press the [Y] or [INPUT] key to reset the check, and the edit operation can be continued. When pressing any other key, "Program checking" displays and the program cannot be edited.
- (4) Up to 255 characters can be input in one block in regular editing and 127 characters in mass-editing.
- (5) "Saving" is displayed in flickering during saving.

3.6.4 Inserting Data (Initial Data Overwrite Mode)

Operation method



- (1) Move the cursor to the position where data is to be inserted.
- (2) Press the [INSERT] key.  The mode changes to the insertion mode. "INS" appears to the right of the file name. The cursor changes to '|'.
- (3) Set the data.
- (4) When the setting is completed, press the [INPUT] key.  The set data is fixed. The cursor does not move, but if there is no EOB (;) at the end of the line, it will be added. Then, the cursor moves to the next line. The mode returns to the overwrite mode, and the message "Editing" disappears.

Note



- (1) Up to 256 characters can be set in one line.
- (2) The insertion mode will be finished if a key such as [DELETE], [C.B], [CAN], [INPUT], [↑], [↓], [←], [→], [|←], [→|],  or  pressed.
- (3) For normal editing, EOB(;) is added to a row without EOB(;), and the cursor moves to the next line. A row with EOB(;) is skipped, and the cursor moves to the next line. (No cursor movement.)
- (4) During mass-editing, linefeed is inserted every time EOB (;) is input. (Cursor moves to the head of the next line.)

3.6.5 Overwriting Data (Initial Data Insertion Mode)

Operation method



- | | | | |
|-----|---|---|--|
| (1) | Move the cursor to the position where data is to be inserted. | | |
| (2) | Press the [INSERT] key. |  | The mode changes to the overwrite mode. "INS" appears to the right of the file name. The cursor changes to '■'. |
| (3) | Set the data. |  | The data is set from the position of the cursor. Data at the area is overwritten. The cursor moves one space (character) at a time to the right as the data is set. |
| (4) | When the setting is completed, press the [INPUT] key. |  | The set data is fixed. The mode returns to the insertion mode, "INS" is displayed in the right side of the file name, and the message "Editing" disappears. The cursor returns to ' '. |

Note



- (1) The insertion mode will be finished if a key such as [DELETE], [C.B], [CAN], [INPUT], [↑], [↓], [←], [→], [|←], [|→], , or  pressed.
- (2) For normal editing, EOB(;) is added to a row without EOB(;), and the cursor moves to the next line. A row with EOB(;) is skipped, and the cursor moves to the next line. (No cursor movement.)
- (3) During mass-editing, linefeed is inserted every time EOB (;) is input. (Cursor moves to the head of the next line.)

3.6.6 Deleting Data



Operation method (Deleting one character) (Deleting by DELETE key action ("#8967 DELETE key action" is set to "0"))

- | | | | |
|-----|---|---|---|
| (1) | Move the cursor to the character to be deleted. | | |
| (2) | Press the [DELETE] key. |  | 1 character is deleted at the cursor position, and "Editing" appears. The data from the cursor position moves to the left. When this key is held down, the characters can be deleted one at a time. |
| (3) | Press the [INPUT] key. |  | The edited machining program is saved to the device and "Editing" disappears. |

Operation method (Deleting one character) (Deleting by BackSpace key action ("#8967 DELETE key action" is set to "1"))

- | | | | |
|-----|---|---|--|
| (1) | Move the cursor to the right side of the character to be deleted. | | |
| (2) | Press the [DELETE] key. |  | 1 character at the left side of the cursor position is deleted, and "Editing" appears. The data from the cursor position moves to the left. When this key is held down, the characters can be deleted one at a time. |
| (3) | Press the [INPUT] key. |  | The edited machining program is saved to the device and "Editing" disappears. |

Operation method (Deleting one line)

- (1) Move the cursor to the line to be erased.
- (2) Press the [C.B] key.  1 line is deleted at the cursor position, and "Editing" appears. The lines following the cursor position are shifted upward. The cursor position does not change. When this key is held down, the line can be deleted one at a time.
- (3) Press the [INPUT] key.  The edited machining program is saved to the device and "Editing" disappears.

Note

- (1) In the case where the block for the deleted line covers multiple lines, these lines are also deleted.
- (2) Last line only with "%" cannot be deleted.
- (3) "Executing" is displayed during line clear. The message flashes every second.

Operation method (Deleting designated lines)

- (1) Press the menu [Line clear].
- (2) Designate the deletion range.  The background color for the range to be deleted turns light blue.



(Example) From line 8 to line 10
8/10 [INPUT]

When deleting 1 line, it is also possible to make a selection using the [↑], [↓] keys and designate by pressing the [INPUT] key.
- (3) Press the [Y] or [INPUT] key.
Press the [N] key not to delete.

Note

- (1) If the [INPUT] key is pressed without setting a line No., the line where the cursor is will be deleted.
- (2) If the last line of the file is the range to be deleted, the last line can be designated as "E".
(Example) From 8th line to last line: 8/E
From 1st line to last line: /E
- (3) "Executing" is displayed in flickering during line clear.
- (4) During mass-editing, a line to be deleted cannot be designated.

Operation method (Deleting several lines (one screen of data) displayed on a screen)



- (1) Press the [CAN] key.  The editing data (machining program) for one screen is deleted and "Editing" appears.
- (2) Press the [INPUT] key.  The edited machining program is saved to the device and "Editing" disappears.

3.6.7 Searching for Character Strings

The specified character string is searched downward from the character after the cursor position.

When the parameter "#19710 Edit-Upward search" is set to "1", the search can be performed upward.





Operation method (when the parameter "#19710" = "0")

- (1) Press the menu [String search].
- (2) Set the character string to be searched for, and press the [INPUT] key.  The character string is searched downward from the character after the current cursor position. If the character string is discovered, the cursor moves to the start of that character string. A message appears if there is no character string applicable to the program. Marking can be performed by adding an option to the character string being searched for. (Example) G20/MR :G20 are marked in red. (Refer to "Marking function" described later for further details.)
(Example) G20 [INPUT]
- (3) To continue searching, press the [INPUT] key again.  The next corresponding character string is searched for. The search finishes when the end of the program is reached.
<Note>
 - It is not possible to return to the head of the program and resume the search. To search from the head of the program, move the cursor to the top line and carry out the search operation again.
- (4) To end the search, press the menu key.  The menu highlight returns to normal, and the character string in the input area disappears. The search mode is held until the menu key is pressed. (The character string remains in the input area.)

Note

- (1) "Executing" is displayed in flickering during string search.
- (2) During mass-editing, the marking cannot be made.

Operation method (when the parameter "#19170" = "1")
■ For downward search

- (1) Press the menu [String search].
- The sub menus of string search are displayed and [Down search] menu is highlighted.
The cursor is displayed in the input area below.
- (2) Set the character string to be searched for, and press the [INPUT] key. 
(Example) G20 [INPUT]
- The character string is searched downward from the character after the current cursor position.
If the character string is found, the cursor moves to the start of that character string.
A message appears if there is no character string applicable to the program.
Marking can be performed by adding an option to the character string being searched for.
(Example) G20/MR :G20 are marked in red.
(Refer to "Marking function" described later for further details.)
- (3) To continue searching, press the [INPUT] key again. 
- The next corresponding character string is searched for.
When the end of the program is reached, the message "OK to search from the top?(Y/N)" appears.
When the search is performed from the start again, press the [Y] or [INPUT] key.
To end the search, press the [N] key. The string search is finished automatically and the screen returns to the main menu. The character string in the input area is deleted.
- (4) To change the search direction, press the menu [Upward search]. 
- The search direction is changed upward.
- (5) To end the search, press the menu [Quit search] or  key. 
- The string search is finished and the screen returns to the main menu. The character string in the input area is deleted.

■ For upward search



- | | |
|---|--|
| (1) Press the menu [String search]. | The sub menus of string search are displayed and [Down search] menu is highlighted.
The cursor is displayed in the input area below. |
| (2) Press the menu [Upward search]. | The [Upward search] menu is highlighted. |
| (3) Set the character string to be searched for, and press the [INPUT] key.
(Example) G20 [INPUT] | <p>→ The character string is searched upward from the character before the current cursor position.
If the target character string is found, the cursor moves to the start of that character string.
A message appears if there is no character string applicable to the program.
Marking can be performed by adding an option to the character string being searched for.
(Example) G20/MR :G20 are marked in red.
(Refer to "Marking function" described later for further details.)</p> |
| (4) To continue searching, press the [INPUT] key again. | <p>→ The next corresponding character string is searched for.
When the start of the program is reached, the message "OK to search from the bottom?(Y/N)" appears.
When the search is performed from the end again, press the [Y] or [INPUT] key.
To end the search, press the [N] key. The string search is finished automatically and the screen returns to the main menu. The character string in the input area is deleted.</p> |
| (5) To change the search direction, press the menu [Downward search]. | The search direction is changed downward. |
| (6) To end the search, press the menu [Quit search] or  key. | <p>→ The string search is finished and the screen returns to the main menu. The character string in the input area is deleted.</p> |

Note

- (1) "Executing" is displayed in flickering during string search.
- (2) The setting of search direction is held until the power is turned OFF. The setting after the power is turned ON again is [Downward search].
- (3) During mass-editing, the marking cannot be made.

Marking function

Character strings to be searched for can be marked in colors.

Argument character string format	Details	Marking color
Search character string	The cursor moves to the character string searched for.	None
Search character string/MR	The cursor moves to the character string searched for. All displayed searched character strings are marked in red.	Red 
Search character string/MB	The cursor moves to the character string searched for. All displayed searched character strings are marked in blue.	Blue 
Search character string/MG	The cursor moves to the character string searched for. All displayed searched character strings are marked in green.	Green 
/MC	The marking for all marked character strings is cleared.	-
/MCR	The marking for character strings marked in red is cleared.	-
/MCB	The marking for character strings marked in blue is cleared.	-
/MCG	The marking for character strings marked in green is cleared.	-

Note

- (1) The marking status is maintained when another program is opened while character strings are still marked.
- (2) If the input mistake check warning function is enabled while character strings are still marked, the marking is given priority in the case where the input mistake location and the marked display overlap.
- (3) In the case where the search marking and input mistake check warning function are displayed simultaneously, the marking is cleared and the input mistake warning display remains.
- (4) With the multi-program display type, the search and marking is valid only in the area where the search and marking is carried out.
- (5) With the multi-program display type, the character string and color to be marked are not synchronized in the each editing area.
- (6) The marked status is maintained until the NC power is turned OFF.
- (7) Marking function is invalid in mass-editing.

Important points when performing search

- (1) If the designated character string cannot be found, the operation message "Designated character string not found" appears.
- (2) A search is performed for a character string containing the designated character string, irrespective of the characters before and after. As a result, if "G2" is designated, G20 - G29 and G200 etc. will also be the subject of a search.
Character string data setting example

Designated character string	Search character string example
N10	Character strings that include "N10" such as "N10" and "N100".
N10 X100.	Character string "N10 X100."
X-012.34	Character string "X-012.34" (A search is not performed for "X-12.34".)





3.6.8 Replacing Character Strings

A character string in a program can be searched for and replaced.

The following three methods can be used.

- The applicable character string is searched for and replaced one by one. (To search for the next character string, press the [INPUT] key.)
- All applicable character strings in the program are replaced in a batch. (Designate "/G" when setting.)
- The program character strings from the current cursor position to the last line are to be replaced in a batch. (Designate "/"E" when setting.)

Operation method

- | | |
|--|---|
| (1) Press the menu [String replace]. | |
| (2) Designate the character string to be searched and replaced.
(Example) Searching for "G02" to replace with "G03"
G02/G03 [INPUT] (*1) |  The character string is searched downward from the next character where the cursor is currently located. When the character string is found, the cursor moves to the first character of that string, and the operation message "Replace?(Y/N)" appears. If any character string is not found in the program, the cursor does not move. |
| (3) Press the [Y] or [INPUT] key.
Press the [N] key not to replace. |  The character string is replaced, and a search is performed for the next applicable character string. (If a batch replacement is performed, a search is not made as the replace operation has been completed.) The operation message "Designated character string not found" appears when the end of the program is reached. "Editing" appears if replace is performed. |
| (4) Press the [Y] or [INPUT] key again if continuing the search/replace. |  The same operation as above is performed. |
| (5) To end search/replace, press the [String replace]. |  The menu highlight returns to normal, and the character string in the input area disappears. The replacement mode is held until the menu key is pressed. (The character string remains in the setting area.) |

(*1) When batch replacing for all the character strings in the program, add "/G" to the above setting.

Character string to be searched/character string to be replaced/G

(Example) G02/G03/G

During batch replacement, after replacing all character strings to the end of the program, the process ends while showing the last character string replaced. Note that the replacement mode is held, and the character string remains in the input area.

Note

- (1) If the program character strings from the current cursor position to the last line are to be replaced in a batch, add "/"E" to the above setting.
Character string to be searched/character string to be replaced/E
(Example) G02/G03/E
- (2) With the multi-program display type, the replacement on the side which is not being edited is not performed.
- (3) "Executing" is displayed in flickering during the replacement.
- (4) During mass-editing, the character string cannot be replaced.

3.6.9 Copying and Pasting Data

Operation method (Copying a line)

- (1) Press the menu [Line copy].
- (2) Designate the copy range.
(Example) From line 8 to line 10
8/10 [INPUT]

➔

 The background color for the range to be copied turns light blue.
 When copying 1 line, it is also possible to make a selection using the [↑] or [↓] key and designate by pressing the [INPUT] key.

Note

- (1) If [INPUT] key is input without setting a line No., the line where the cursor is at is copied.
- (2) The highlight of the copy target lines disappears when editing operations are resumed.
- (3) If the file is edited, or turned back to the previous saved status by pressing the menu [Undo] after the Line copy menu is pressed, the data copied in the line is canceled.
- (4) During mass-editing, the string copy cannot be performed.
- (5) If the last line of the file is the range to be copied, the last line can be designated as "E".
(Example) From 8th line to last line: 8/E
- (6) The copied data is maintained while the copy source file is opened even if the display type or editing area is switched to another one. The data will be discarded after screen transition.

Operation method (Copying character)

- (1) Move the cursor to the head character to be copied.
- (2) Press the menu [Char copy].
- (3) Move the cursor to the end character to be copied, and press the [INPUT] key.

➔

 The background color for the range to be copied turns light blue. The range is fixed by pressing the [INPUT] key.

Note

- (1) Characters of up to 500 bytes can be copied at a time. When the size of the selected characters exceeds 500 bytes, the message "Can not copy more" appears and the cursor does not move.
- (2) The Copying will be canceled, if the [↑], [↓], [←], [→], [|←] or [|→] key is pressed before pressing the [INPUT] key.
- (3) Light blue background for copy range will disappear when editing operation is resumed.
- (4) As long as the original file is opened, the copied content will be saved even if you change the display type or shift the display left and right side. The data will be discarded after screen transition.

Operation method (Pasting the copied data)

- (1) Move the cursor to the line where the data is to be pasted.
- (2) Press the menu [Paste].
 - ➔ <When copying a line data>
The copied data is inserted upward on the line where the cursor is positioned.
 - <When copying characters>
The copied data is inserted in front of the cursor position.
 - <Note>
 - ◆In the overwrite mode, the data is inserted in front of the cursor position as well.
- (3) Press the [INPUT] key.

Note

- (1) With multi-program display type, data can be copied and pasted between the each editing areas by pressing the [←→ change] key.
- (2) "Executing" is displayed in flickering during pasting.
- (3) During mass-editing, copied data in the regular editing mode cannot be pasted.
- (4) EOB is not converted to line feed code only when the character including EOB is copied with the program opened in mass-editing and pasted to the program in mass-editing. EOB is pasted converted to line feed code even if EOB has a comment in the following cases.
 - ◆When copied from the mass-editing screen and the pasted to regular editing screen
 - ◆When copied from the regular editing screen and pasted to the regular editing screen
 - ◆When copied from the regular editing screen and pasted to the mass-editing screen

3.6.10 Undoing Program Changes

This is used to return the program to the form when [INPUT] was last pressed to save. This operation is valid for the operation of "Rewriting program", "Insert", "Delete", "Line Paste", "Line Clear", "Character String Replace" and "Undo" functions.

Operation method

- | | |
|---|---|
| (1) Change the operation to memory mode, and then press the main menu [Edit]. | |
| (2) Move the cursor to the position to be corrected, and input a character.
(Example) 135
If [Undo] is pressed during "Editing", the system will be returned to the state saved last. | |
| (3) Press the [INPUT] key. | ➔ The edited machining program is saved to the device.
The message "Editing" disappears. |
| (4) Press the menu [Undo]. | ➔ The contents of the file return to the same condition as when the editing was started.
These contents of the file are saved to the device. |
| (5) Press the menu [Undo] again. | ➔ The contents of the file return to the same condition as when the file was saved in the procedure (3).
These contents of the file are saved to the device. |

Note

- (1) This function is only valid when parameter "#8910 Edit undo" is set to "1".
- (2) When returned to the previous status, the cursor will move to the head line.
- (3) With the multi-program display type, returning to the previous contents is valid only in the active area.
- (4) Undoing is not possible in mass-editing mode.
- (5) When undoing is performed, the copied data will be canceled.
- (6) "Executing" is displayed in flickering during undoing.
- (7) When the parameter "#8939 Undo confirm msg" is set to "1", if [Undo] is pressed, the menu is highlighted and the operation message "OK?(Y/N)" appears. The program returns to the previous status by pressing [Y] or [INPUT] key. If other key is pressed, the operation is canceled. When the operation is canceled, the menu highlight returns to normal and the message is deleted.
- (8) When the program does not return to the previous status by pressing [Undo], [Undo] is not highlighted and the operation message "Data protect" or "Executing automatic operation" appears.

3.6.11 Searching T codes

T codes (e.g T03, T0101) in a machining program can be searched.
You can search T codes both upward and downward.

(1) Press the menu [Down Tsearch].



The T code is searched downward from the next character where the cursor is currently located. When the T code is found, the cursor moves to the position of the T code.
The message "Designated T code not found" appears if there is no designated T code in the program.

(2) <To search downward consecutively>
Press the menu [Down Tsearch].



The next T code is searched.
When the search is reached the end of the program, the message "OK to search from the top?(Y/N)" appears.
When the search is performed from the start again, press the [Y] or [INPUT] key.
To end the search, press the [N] key.

<To search upward>

Press the menu [Upward Tsearch].



The character string is searched upward from the next character where the cursor is currently located. When the T code is found, the cursor moves to the position of the T code.
When there is no designated T code on the upper area where the cursor is currently located, the message "OK to search from the bottom?(Y/N)" appears.
When the search is performed from the bottom again, press the [Y] or [INPUT] key.
To end the search, press the [N] key.

Note

(1) The T code included in the comment is not searched.

The description which meets the following conditions is regarded as a T code and is to be searched.

- ♦The description before "T" must not be an alphabetical character.
- ♦The description which follows "T" must be any of "#", "[", "+", or "-".

(2) If the searching takes time, "Executing" is displayed in flicking every one second.

3.7 Program Editing Support Function



3.7.1 Displaying Input Mistakes

The input mistake check warning function regards the following cases as input mistakes and displays a warning.

Check item	Warning display range	Details
No decimal point input	Applicable address and data	The decimal point was omitted from the data. (Example) N01 G0 X100 Y50.; "X100" displayed as warning

The addresses to check no decimal point input are shown below.

(○:Check performed, -: No check performed)

Address- es	Decimal point command	Application	M/L	Decimal point check
A	Enabled	Coordinate position data		○ Only for axis name
	Disabled	Miscellaneous function code		
	Enabled	Geometric linear angle data		
	Disabled	Rotation table	M	
	Disabled	MRC program number	L	
	Disabled	Data settings, axis number	L	
	Enabled	Deep hole drilling cycle (2) Safety distance	L	
B	Enabled	Coordinate position data		○ Only for axis name
	Disabled	Miscellaneous function code		
	Disabled	Rotation table	M	
C	Enabled	Coordinate position data		○ Only for axis name
	Disabled	Miscellaneous function code		
	Enabled	Corner chamfering amount (.C)		
	Disabled	Rotation table	M	
	Enabled	Program tool compensation input	L	
	Enabled	Nose R compensation amount (Incremental)	L	
D	Disabled	Compensation number (tool position, tool radius compensation)	M	-
	Enabled	Auto tool length measurement, deceleration ranged	L	
	Enabled	Data settings	L	
	Disabled	Sub-program storage device number (.D)	M	
E	Enabled	N number of threads per inch, precision thread lead		-
F	Enabled	Feedrate		-
	Enabled	Thread lead		
G	Enabled	Preparation function code		-
H	Disabled	Sequence number in sub-program		-
	Disabled	Compensation number (tool position, tool length compensation)	M	
I	Enabled	Circular center coordinates		○
	Enabled	Vector component for tool radius compensation/nose R compensation		
	Enabled	Custom fixed cycle hole pitch	M	
	Enabled	1st cut amount for deep hole drilling cycle (2)	L	



3 Inputting a Machining Program and Defining Variables

Address- es	Decimal point command	Application	M/L	Decimal point check
J	Enabled	Circular center coordinates		○
	Enabled	Vector component for tool radius compensation/nose R compensa- tion		
	Enabled	Custom fixed cycle hole pitch, angle	M	
	Disabled	Dwell at deep hole drilling cycle (2) return point	L	
K	Enabled	Circular center coordinates		○
	Enabled	Vector component for tool radius compensation/nose R compensa- tion		
	Disabled	Custom fixed cycle hole count	M	
	Disabled	Hole drilling cycle repeat count	L	
	Enabled	2nd cut amount for deep hole drilling cycle (2)	L	
	Disabled	Fixed cycle repeat count	M	
L	Disabled	Sub-program repeat count		-
	Disabled	Fixed cycle repeat count	M	
	Disabled	Program tool compensation input type selection (L2, L10, L11)	L	
	Disabled	Data setting selection (L70)	L	
M	Disabled	Miscellaneous function code		-
N	Disabled	Sequence No.		-
	Disabled	Data setting, data number	L	
O	Disabled	Program No.		-
P	Enabled/ Disabled	Dwell time (parameter)		-
	Disabled	Sub-program call program number		
	Disabled	Program tool compensation input compensation number		
	Disabled	Custom fixed cycle hole count	M	
	Disabled	Helical pitch count	M	
	Disabled	Surface speed radius	M	
	Enabled	Scaling factor	M	
	Disabled	High-speed mode type	M	
	Disabled	2nd reference position number	L	
	Disabled	Constant surface speed control axis number	L	
	Disabled	MRC finished shape start sequence number	L	
	Enabled	Cut-off cycle, shift amount/cut amount	L	
	Disabled	Compound thread cutting cycle cut count, chamfering, nose angle	L	
	Enabled	Compound thread cutting cycle thread height	L	
	Disabled	Data settings large division number	L	
	Disabled	Restore sequence number fro sub-program	L	
	Enabled	Coordinate position data	L	
Q	Enabled	Deep hole drilling cycle cut amount	M	-
	Enabled	Back boring shift amount	M	
	Enabled	Fine boring shift amount	M	
	Disabled	Spindle minimum clamp rotation speed	L	
	Disabled	MRC finished shape end sequence number	L	
	Enabled	Cut-off cycle cut amount/shift amount	L	
	Enabled	Compound thread cutting cycle minimum cut amount	L	
	Enabled	Compound thread cutting cycle 1st cut amount	L	
	Enabled	Cut amount each time for deep drilling cycle 1	L	
	Disabled	Program tool compensation input hypothetical nose point number	L	
	Disabled	Dwell at cut point for deep drilling cycle 2	L	

3 Inputting a Machining Program and Defining Variables

Address- es	Decimal point command	Application	M/L	Decimal point check
R	Enabled	R-designated circular radius		○
	Enabled	Corner rounding circular radius (.R)		
	Enabled	Program tool compensation input compensation amount		
	Enabled	Fixed cycle R point	M	
	Enabled	Synchronous tap/asynchronous tap change	M	
	Enabled	Auto tool length measurement deceleration area r	L	
	Enabled	MRC longitudinal, edge, and escape amount	L	
	Disabled	MRC molding division amount	L	
	Enabled	Cut-off cycle return amount	L	
	Enabled	Cut-off cycle escape amount	L	
	Enabled	Compound thread cutting cycle finishing allowance	L	
	Enabled	Compound thread cutting cycle, cutting cycle taper difference	L	
	Enabled	Distance to R point for hole drilling cycle, deep hole drilling cycle 2	L	
	Enabled	Coordinate position data	L	
S	Disabled	Spindle function code		-
	Disabled	Spindle maximum clamp rotation speed	L	
	Disabled	Constant surface speed control surface speed	L	
T	Disabled	Tool function code		-
U	Enabled	Coordinate position data		○ Only for axis name
	Disabled	2nd miscellaneous function code	L	
	Enabled	Program tool compensation input	L	
V	Enabled	Coordinate position data		○ Only for axis name
	Disabled	2nd miscellaneous function code	L	
	Enabled	Program tool compensation input	L	
W	Enabled	Coordinate position data		○ Only for axis name
	Disabled	2nd miscellaneous function code	L	
	Enabled	Program tool compensation input	L	
X	Enabled	Coordinate position data		○ Only for axis name
	Enabled	Dwell time		
	Disabled	2nd miscellaneous function code	L	
	Enabled	Program tool compensation input	L	
Y	Enabled	Coordinate position data		○ Only for axis name
	Disabled	2nd miscellaneous function code	L	
	Enabled	Program tool compensation input	L	
Z	Enabled	Coordinate position data		○ Only for axis name
	Disabled	2nd miscellaneous function code	L	
	Enabled	Program tool compensation input	L	

Performing a consecutive input mistake check when creating a program

- (1) Press the menu [Open (New)], input a new file name, and press the [INPUT] key.  Only an EOR program is created.
- (2) Press the menu [Miss warning].
- (3) Edit the program.  A warning is displayed at the moment the [INPUT] key is pressed.

```
Memory:/Program
File 100
Line 1 - 3
 1 G28 XYZ;
 2 G00 X1 ;
 3
```

- (4) Correct the input mistake and continue with program creation.

Performing a batch input mistake check for an existing program

- (1) Change the operation to memory mode or MDI mode and perform a machining program operation search.
- (2) Press the menu [Edit].
- (3) Press the menu [Miss warning].  A warning displays the position where an input mistake occurred.
The cursor moves from its current position to the first input mistake that was found.

```
Memory:/Program
File 348 Editing
Line 11 - 26
11 F1000 S3000 ;
12 M3 ;
13 N20 ;
14 G41 D3 ;
15 G3 Z-20. I20. P3. ;
16 G1 X90. Y100. F1000 ;
17 G91 X100. ;
18 Y100 ;
19 X-100 ;
20 Y-110 ;
21 N30 ;
22 G90 G0 Z5. ;
23 G40 ;
24 G91 G28 Z0 ;
25 M2 ;
```

- (4) Press the menu. [Next miss]



The cursor moves to the next input mistake position.

```
Memory:/Program
File 348 Editing
Line 11 - 26
11 F1000 S3000 ;
12 M3 ;
13 N20 ;
14 G41 D3 ;
15 G3 Z-20. I20. P3. ;
16 G1 X90. Y100. F1000 ;
17 G91 X100. ;
18 Y100 ;
19 X-100 ;
20 Y-110 ;
21 N30 ;
22 G90 G0 Z5. ;
23 G40 ;
24 G91 G28 Z0 ;
25 M2 ;
```

- (5) Correct the input mistake and continue with program creation.

Precautions

- (1) The input mistake check timing is outlined in the following table.



Timing	Check range	Check item	Example
When an edit key (alpha-bet, numbers, symbols, [Delete] etc.) is pressed (Does not include the cursor key and [Page Up/Down] keys.	1 block where the cursor is located	Decimal point	A warning is displayed upon pressing [INPUT] when "X10;" is input.
			A warning is displayed upon pressing [INPUT] when the "X10.Y" "." is inserted in the case where "X10Y" is input.

If the menu [Miss warning] is pressed again when the input mistake check warning function is enabled, this function is then disabled. The character color of the location of an input mistake then returns to normal.

- (2) The menu [Next miss] is grayed out and cannot be selected when the menu [Miss warning] is not highlighted.
- (3) An input mistake check warning function can be performed even when editing a MDI program.
- (4) An input mistake check warning function can also be performed for a comment block.
- (5) If the data in an address that is subject to a decimal point input mistake is "0", no warning is issued regardless of the presence of a decimal point.
(Example: No warning is issued for "X0")
If the data in an address that is subject to a decimal point input mistake has been omitted, no warning is issued.
(Example: No warning is issued for "G28XYZ")
- (6) Blocks with "[", "]" are not subject to an input mistake check warning function.
- (7) The input mistake status is held in the operation screen edit window, setup screen MDI edit window, and edit screen edit area.
- (8) If an input mistake is found after the current cursor position, the operation message "Input miss was detected" appears. If no input mistake is found, the operation message "Input miss was not detected" appears.
- (9) With the multi-program display type, the input mistake check of the non-active area is not performed. When the editable side is switched with the menu [←→ change] during the input mistake check warning function ON, the cursor moves to next input mistake position. The messages "Input miss was detected" and "Input miss was not detected" are judged referring to the cursor position on the side being edited.
- (10) Input mistake check warning function is disabled in mass-editing.
- (11) "Executing" is displayed in flickering during checking input mistakes.
- (12) Decimal point command is enabled or disabled for each address depending on the G code type, but the input mistake check is independent of the G code type. Thus the mistake check is carried out while the state of whether the decimal point command is enabled or disabled is kept the same for each address. Refer to the table in the previous section for whether the decimal point command is enabled or disabled for each address.

3.7.2 Performing Operation Search at the Cursor Position

By pressing the menu [Cursor OP srch] when the device is in the normal status (not being in status such as editing or character searching, etc.), operation search of the selected part system is carried out starting.

- (1) Select the part system that the cursor operation search is performed.
- (2) Open the program on the edit screen.  The program edit window appears.
- (3) Move the cursor to the block to be carried out the cursor operation search.
- (4) Press the menu [Cursor OP srch].  Operation search is carried out starting from the block that the cursor is positioned. During the search "Searing" will display blinking. After search is completed, the display returns to the monitor screen.

Note

- (1) When the parameter "#1285 ext21/bit0" (Multi-part system program management) is set to "1" (valid), the menu [Cursor OP srch] is disabled and the cursor operation search cannot be performed.
- (2) During program editing, the menu [Cursor OP srch] is disabled and the cursor operation search cannot be performed.
- (3) During the MDI program is displayed, the menu [Cursor OP srch] is disabled and the cursor operation search cannot be performed.
- (4) During automatic operation, checking or restart search by selected part system, the cursor operation search cannot be performed displaying the messages "Executing automatic operation", "Program checking" and "Program restarting" for each status.
In such cases, the display does not transit to the monitor screen. However, it is enabled when the parameter "#11039 Cusr pos srch typ" is set to "1" even if the operation is under single block stop. For details, refer to "Search during single block stop" in "10.6.1 Program Editing".
- (5) During automatic operation, checking or restart search by other than the selected part system, the cursor operation search can be performed, and the messages "Executing automatic operation", "Program checking" and "Program restarting" will not appear. In this case, the display transits to the monitor screen.
- (6) The cursor position search is not available for the sub part system I or II in M80/M80W Series, or the sub part system II in M800 Series. This menu is non-selectable when the search cannot be operated.

3.7.3 Adding Sequence No. (N No.) Automatically

When the sequence No. (N No.) is input once, the sequence No. to which a constant value is added can be automatically added to each block of the machining program.

The added sequence No. data is to N2 to N99999999.

This function is disabled during mass-editing.

Operation method

(1) Press the menu [N auto add].

(2) Input the incremental value.
(Example) 10 [INPUT]

<When creating a new program>

(3) Press the menu [Open (New)], then press the menu [Memory].

(4) Input a file name not used, then press the [INPUT] key.
(Example) 101

(5) Input a program with N No.
(Example) N100G28XYZ

<When editing an existing program>

(3) Press the menu [Open], then press the menu [Memory].

(4) Select a file, then press the [INPUT] key.

(5) Move the cursor to the position where data is to be inserted. Press the [INSERT] key.

(6) Input " ; " (EOB).

(7) Input the second block data and " ; " (EOB).
(Example) G92X0.Y0.Z0.;

(8) Press the [INPUT] key.

Note

- (1) When the menu [N auto add] is pressed again while the menu is highlighting, N No. additional value display column is cleared, and N No. automatic addition is canceled.
- (2) The setting range is 1 to 1000. When "01" is input, "1" is set. When "0" is input, this function is canceled. When an illegal value or 9 characters or more is input, an error will occur.
- (3) When "0" is input, this function is canceled.
- (4) When an illegal value or 9 characters or more is input and [INPUT] is pressed, the "Setting error" appears.
- (5) The incremental value can be set even when the machining program has been not opened. Even if the machining program is opened again, the incremental value is not invalid.
- (6) The incremental value is not cleared with the screen transition.
- (7) This function is enabled only during regular editing of edit screen.
- (8) This function is disabled during mass-editing. However, the set N No. additional value in regular editing is not cleared, and the additional value is valid during regular editing again.
- (9) Even if the same N No. exists by automatic addition, an error will not occur.
- (10) The system separately has N No. in a right area and left area of the edit screen.
- (11) When the previous block is leading zero like "N010", N No. automatic addition can be executed. However, "0" is not added, and "N10" is displayed.

Example when N No. is added

(1) When the previous block has N No. (When the cursor is located at the last character in the overwrite mode.)

```
N100 G28 X0 Y0 Z0 ; -> Input ";" -> N100 G28 X0 Y0 Z0;N110;
N100 G28 X0 Y0 Z0 ; -> Input ";" -> N100 G28 X0 Y0 Z0 ;N110;
N100 G28 X0 Y0 Z0 ; -> Input ";" -> N100 G28 X0 Y0 Z0 ;N110;
```

(2) When the previous block has N No. (When the insertion mode)

```
N100 G28 X0 Y0 Z0 ; -> Input ";" -> N100 G;N11028 X0 Y0 Z0 ;
N100 G28 X0 Y0 Z0 ;N200G90X20.Y20.Z20.; -> Input ";" -> N100 G28 X0 Y0 Z0 ;N110N200G90X20.Y20.Z20.;
```

Example when N No. is not added

(1) When the previous block has no N No.

```
G00X10.%; -> Input ";" -> G00X10.;%
```

(2) When the head of previous block has no N No.

•Usually

```
G00N100X10.%; -> Input ";" -> G00N100X10.;%
```

•When comment

```
(N100)G00N100X10.%; -> Input ";" -> (N100)G00N100X10.;%
```

•When the previous block has a space

```
N100G00N100X10.%; -> Input ";" -> N100G00N100X10.;%
```

(3) When the N No. of previous block is over 9 characters.

```
N000001000%; -> Input ";" -> N000001000%;%
```

(4) When limits of total characters display per block is exceeded.

(5) When the N No. is over 100000000.

(6) When the N No. automatic additional value is not set.

(7) When the display character string in overwrite mode is interrupted.

```
N100 G28 X0 Y0 Z0 ; -> Input ";" -> N100 G28 X0;Y0 Z0 ;
```

3.7.4 G Code Guidance

For details, refer to "2.7.3 G Code Guidance".

3.7.5 Playback Editing



The playback function enables creation of a program while trying sample machining by manual (handle or jog) feed or mechanical handle feed. A machining program can be created with movement distance data obtained by manual operation used as programmed command values.

The playback counter and valid address key (X, Y, U, V, etc.) are different depending on the parameter "#1076 AbsInc" (ABS/INC address) setting. A parameter "#1076 AbsInc" can be set individually for each part system.

	#1076 AbsInc (For L system only)	#1126 PB_G90	Reference
M system	(This setting is meaningless.)	0 (Incremental position)	Absolute command/incremental command depending on G command
		1 (Absolute position)	
L system	0 (Absolute command/incremental command with G command)	(This setting is meaningless.)	Absolute command/incremental command depending on address code
	1 (Absolute command/incremental command with address code)		

<Absolute command/incremental command with G command (M/L System)>

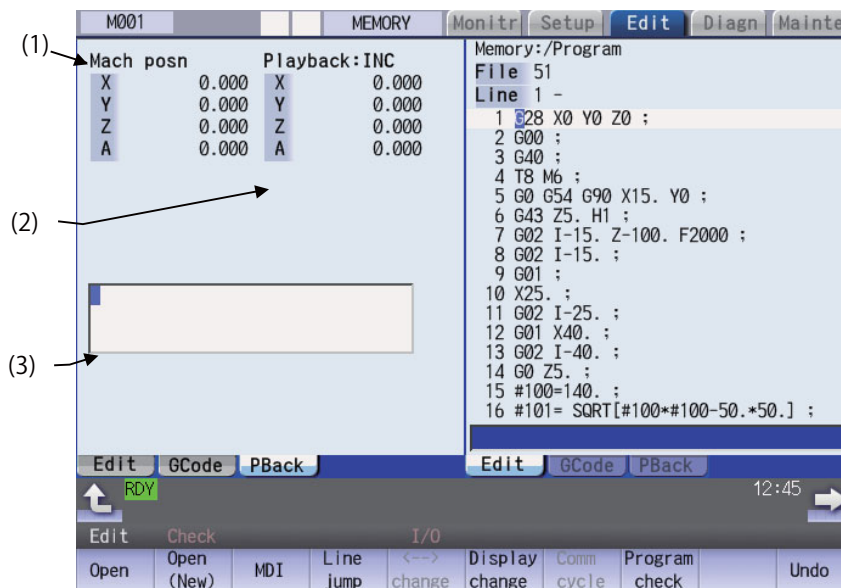

Display items

Display items	Details
(1) Machine position counter	This displays the machine position counter. Up to max. number of axes in a part system can be displayed. M system: Max. eight axes L system: Max. five axes, the sixth axis or later is switched by the menu [Next axis]. When the rotary axis (except for all coordinate linear type), the display range is 0.000° to 359.999°.
(2) Playback counter	This displays the playback movement amount (axis movement value). When the absolute command or incremental command depends on G command, the title and playback movement amount differs according to the parameter "#1126 PB_G90". (*1) When the absolute command or incremental command depends on address code, both titles are displayed. Up to max. number of axes in a part system can be displayed. M system: Max. eight axes L system: Max. five axes, the sixth axis or later is switched by the menu [Pback next ax]. When the rotary axis (except for all coordinate linear type), the display range is as below: For INC (Rotary type short-cut disabled, workpiece coordinate linear type): -359.999° to 359.999° For INC (Rotary type short-cut enabled): -180.000° to 179.999° For ABS: 0.000° to 359.999°
(3) Playback editing input area	The contents of playback editing is input. When the axis address keys such as X and Y are input, the playback counter value currently displayed is input after the axis address.

(*1) The displayed title and playback movement amount are as follows.

#1126 PB_G90	Title	Playback movement amount
0 (Incremental position)	Playback: INC	Playback movement amount before axis moves + axis movement amount
1 (Absolute position)	Playback: ABS	The program position + manual interrupt amount

Axis name displayed on the playback counter:

#1266 ext02/bit0 Axis name extension valid	#1601 axnameEx Axis name extension letter	Axis name to be displayed
0 (Invalid)	-	This displays the axis name set by the parameter "#1013 axname".
1 (Valid)	Already set (Name extension axis)	This displays the combination of the axis name set by the parameter "#1013 axname" and the axis name extension character set in "#1601 axnameEx".
	Not set (Non-name extension axis)	This displays the axis name set by the parameter "#1013 axname".

Operation method (Absolute command/incremental command with G command)

- (1) Set "#1126 PB_G90" to "0" on the parameter screen. ➡ Incremental value mode is set.
- (2) Press the main menu [Edit] on the edit screen, and press [Displaychange] or  key several times. ➡ The "playback display type" is displayed. The menu [←→ change] cannot be used. When the incremental value is set, the initial value is "0".
- (3) Open the program pressing [Edit] and [Open] on the edit screen. ➡ The selected program is displayed in right area.
- <Note>
- When the program is displayed on the right side, the playback edit is displayed on the right side.
 - When the incremental value is set, playback movement amount will be cleared to "0" for all axes.
- (4) Move the axis during manual mode. ➡ The axis movement amount is displayed in playback movement amount. When the absolute position is set, "the program position + manual interrupt amount" is displayed as the playback movement amount. In the incremental value mode, the axis movement amount by manual mode is added to currently playback movement amount.
- (5) Input the data such as the G codes in the area for playback editing. ➡ The alphanumeric characters, [←], [→] and [DELETE] keys can be input in the area for playback editing.
- <Note>
- If the [C.B] key is pressed, all the data in the playback editing area is deleted.
 - When the [↑] or [↓] key is pressed, the program cursor in the program editing area will move.
 - When the page up key or page down key is pressed, the program in the program editing area will scroll.
 - When the menu key is pressed, the process corresponding to the program editing area will run. When the cursor appears on input area of the program editing area by pressing [Line jump], [Line copy], [Line clear], [String search], [String replace], [MDI registration] or [N auto add], the key input is made to the input area of the program editing area. When window is displayed by pressing [Open], [Open(New)] or [Erase file], the key input is made to the currently displayed window.
 - The program cursor in the program editing area cannot move left and right, but can move only up and down.
- (6) Press the axis address key such as [X] or [Y]. ➡ The playback movement amount is input after the axis address in the playback editing area. If the axis address key is pressed while the playback movement amount is being changed, the playback movement amount at the time the key was pressed will be input.
- <Note>
- When inputting a comment, etc., the characters that are the same as the axis address will all be handled as the axis address.

(7) Press the [INPUT] key.



The program in the playback editing area will be inserted at the block before the cursor position in the right area, is saved.

When there is no "EOB" (;) at the end of the character string, it is added automatically.

The cursor moves to the line head being cleared the content of the playback edit.

For an absolute position, the playback movement amount will not change.

For an incremental value, the difference of the axis command value for the axis used in step (6) and the playback movement amount will remain as the playback movement amount.

The program in the program editing area is saved.

Operation method (Absolute command/incremental command with address code)

(1) Confirm that the parameter "#1076 AbsInc" is "1".

(2) Edit a program the same as the procedure (2) to (7) of "Absolute command/incremental command with G command".

Notes for playback editing

(1) Playback editing of a program in automatic operation or program restart is not possible.

(2) Up to 95 characters can be edited in the playback editing area.

(3) If the program created by playback editing is not suffixed by "EOB(;)", it is automatically added by [INPUT].

(4) If the screen/part system is changed or the program file is opened when the input program is in the playback edit area, the program being edited will be aborted. The playback absolute counter has the G92 coordinate system preset released, and returns to "program position + manual interrupt amount". The playback increase counter is cleared to "0".

(5) Other files can be opened during playback editing. Playback editing can be continued even when other file is opened. However, if an incremental value is designated, the playback movement amount will be cleared to "0" for all axes. A new file can be created and edited, and MDI editing carried out in the same manner.

(6) If the program being playback edited automatically starts, playback editing cannot be continued.

(7) The playback movement amount after playback editing will differ according to the parameter "#1126 PB_G90" state and the commanded G code. The playback movement amount after [INPUT] is pressed is calculated for each block that has been playback edited.

X axis playback movement amount before editing	Details to be playback edited	X axis playback movement amount after [INPUT]	
		For an absolute position	For an incremental position
X 100.000	G01 X10.;	X 100.000 The program position + manual interrupt amount is inserted as the playback movement amount.	X 90.000 The difference of the axis command value (X10.) and playback movement amount before [INPUT] (X100.) is inserted as the playback movement amount.
	G92 X10.;	X 10.000 The command value (X10.) following G92 is inserted as the playback movement amount.	X 0.000 Regardless of the command value following G92, "0" is inserted as the playback movement amount.

(8) The playback editing is disabled during mass-editing.

(9) Do not set the same address to the parameter "#1013 axname" and "#1014 incax". If the same address is set, the absolute counter has priority. (However, the same address as the address used in other part system can be specified.)

(10) The playback editing cannot be enabled for an axis of auxiliary axis state. When an axis address of auxiliary axis state is input, a setting error will occur.

3.7.6 Displaying the Finished Shape

The finish shape view function displays the shape appropriate to the command at the time of machining program input, and this function is intended to eliminate programming errors. You can easily confirm the machining shape without automatic operation or graphic check.

This function is an additional specification. To use this function, the setting by the MTB is required.

Press the menu [Displaychage] on the edit screen to switch to the "Shape" display type.

Confirming the machining shape when programming

- (1) Press the menu [Open (New)] , input a new file name, and press the [INPUT] key.
- (2) When you enter program blocks, they are reflected in the machining shape.

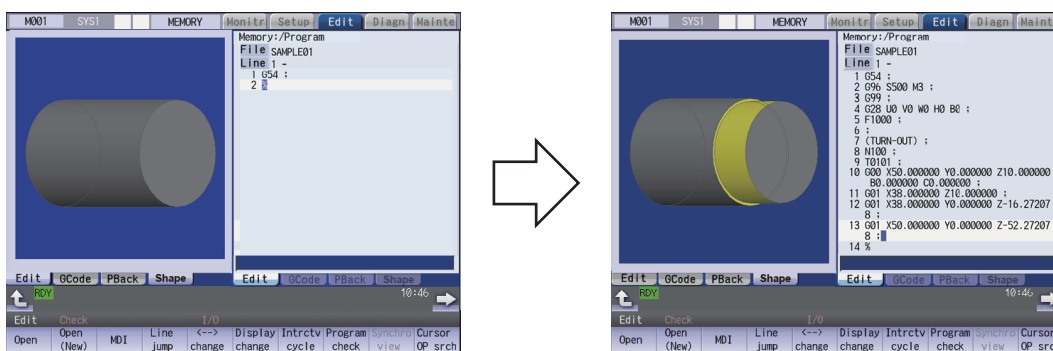

Confirming the machining shape with the existing program

- (1) Press the menu [Open], select the machining program and then press [INPUT] key.
- (2) When you press the menu [View Update], the input machining program is reflected in the machining shape.
- (3) When you add a program block, it is reflected in the machining shape.

Note

- (1) The finish shape view function cannot draw a serial or MDI program.
- (2) Even when enlarging/reducing, moving, rotating, cross-section surface or automatic scale is operated while the workpiece is being displayed, the workpiece shape is not initialized.
- (3) For the models other than M800W Series, if you open the finish shape view, switch it to 3D program check, and then return to the finish shape view, the workpiece shape is initialized.
- (4) When you select [Displaysetting] - [3 edit] or [4 edit] on 15-type or 19-type display, the machining program of the selected editing area is reflected to the finish shape.

3.8 Editing a Multi-part System Program

The parameter "#1285 ext21/bit0" (Multi-part system program management) sets this function valid or invalid.

This function can be used when [Memory] is selected as a device.

3.8.1 Multi-part System Simultaneous Program Editing

When the parameter "#8977 Multi-\$ simul edit" is set to "1" (valid), if you perform the operation (*1) to open a machining program in NC memory on the edit screen, the specified machining program of the displayed part system in the currently selected editing area and the machining program (*2) of the same name in another part system in the deselected editing area are opened simultaneously in the right and left panes.

(*1) To open a machining program, follow the steps shown below. The details on each operation are described in the table later.

- Select menu [Edit] - [Open] to open an existing machining program.
- Select menu [Edit] - [Open(New)] to create and open a new machining program.
- The parameter "#8938 Edit-Not show Prg" is set to "0" and the display changes to the edit screen after operation search or check search has been carried out. Then, the searched machining program is opened automatically.

(*2) The machining program that satisfies the following conditions is opened in the deselected editing area.

- Machining program in another part system of the same name as for the machining program that is to be opened in the currently selected editing area
- If any machining program that satisfies machining program conditions is not registered in the smallest part system other than the currently selected part system, no machining program is opened in the deselected editing area. Then, the machining program opened in the deselected editing area is closed.

Note

- (1) If a machining program in NC memory is opened while the parameter "#8977 Multi-\$ simul edit" is set to "1" (valid), the machining program opened in the deselected editing area is closed.
- (2) The multi-part system simultaneous program editing is also available for MTB macro program and MDI.
- (3) When the machining program for multi-part system simultaneous program editing is opened while the display type is not set to the multi-program display type, if the display type is changed to the multi-program display type, the machining program that is in another part system, of the same name as for the machining program opened in the currently selected editing area is displayed in the deselected editing area.

Operation to select the menu [Edit] - [Open] and open an existing machining program (Case in which the 1st part system is set as the displayed part system)

<For 2-program simultaneous editing>

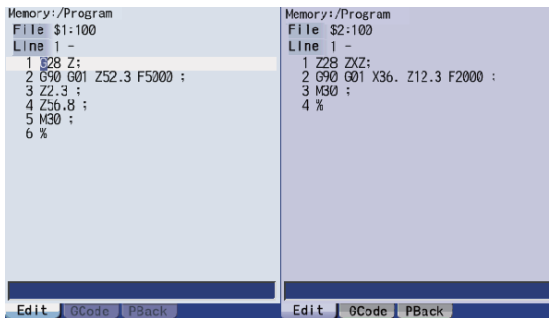

○: Machining program registered ×: No machining program registered

\$1	\$2 (*1)	Operation
○	○	A programs in the 1st part system is displayed in the currently selected editing area, and that in the 2nd part system is simultaneously displayed in the deselected editing area.
○	×	This displays a machining program in the 1st part system in the currently selected editing area. Then, if the machining program is opened in the deselected editing area, it is closed.
×	○	A confirmation message (*2) is then displayed. Selecting "Y" creates and displays a new empty file in the 1st part system in the currently selected editing area. Machining programs in the 2nd part system are displayed in the deselected editing area.
×	×	If the designated machining program does not exist in all part systems, the message "Designated file does not exist" appears, that machining program is not displayed.

<For 3-program simultaneous editing> (15-type/19-type)

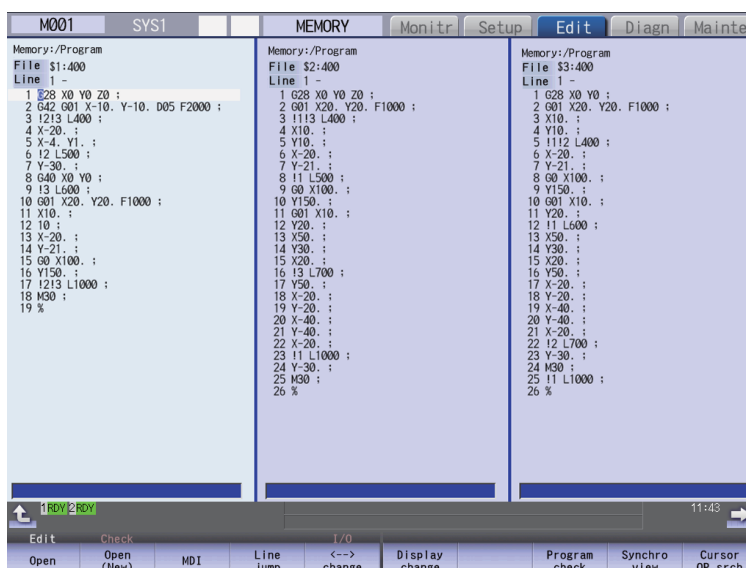

○: Machining program registered ×: No machining program registered

\$1	\$2 (*1)	\$3 (*1)	Operation
○	○	○	A machining program in the 1st part system is displayed in the currently selected editing area, and those in the 2nd and 3rd part systems are simultaneously displayed in the deselected editing areas. The position to open the machining program in the 2nd and 3rd part system will be decided depending on the position of the currently selected editing area; on the left, in the middle or on the right. (The machining program will be opened in empty area from the left in ascending order of the part systems. Even though the G code guidance is displayed, the machining program will be opened behind the G code guidance.)
○	×	×	This displays a machining program in the 1st part system in the currently selected editing area. Then, if the machining program is opened in the deselected editing area, it is closed.
○	○	×	This displays a machining program in the 1st part system in the currently selected editing area. This displays a machining program in the 2nd or the 3rd part system in deselected editing area. Then, if the machining program is opened in another deselected editing area, it is closed.
○	×	○	
×	○	×	A confirmation message (*2) is then displayed. Selecting "Y" creates and displays a new empty file in the 1st part system on the currently selected editing area.
×	×	○	A machining program in the 2nd or the 3rd part system is displayed in the deselected editing area. Then, if the machining program is opened in another deselected editing area, it is closed.
×	○	○	A confirmation message (*2) is then displayed. Selecting "Y" creates and displays a new empty file in the 1st part system on the currently selected editing area. Machining programs in the 2nd and the 3rd part systems are displayed in the deselected editing areas. Then, if the machining program is opened in another deselected editing area, it is closed.
×	×	×	If the designated machining program does not exist in all part systems, the message "Designated file does not exist" appears and that machining program is not displayed.

(*1) For part systems other than the 1st part system, the 2nd or the 3rd part system is described as a typical one.

(*2) The operation message "Create new file?(Y/N)" appears. If "N" is selected, the message "A file does not exist" appears, and the target file is not opened. If "Y" is selected while the remaining number of registered machining programs is "0", the message "Program entry over" appears, and no machining program is displayed. When the parameter "#1285 ext21/bit2" (Multi-part system program generation and operation) is ON, "Create new file?(Y/N)" does not appear and the file will not be opened.

Operation to select the menu [Edit] - [Open (New)] and open an existing machining program (Case in which the 1st part system is set as the displayed part system)

Multi-part system program generation and operation (#1285 ext21 bit2)	Operation
ON (Newly creates only a machining program in the displayed part system.)	This displays machining programs in the 1st part system in the currently selected editing area. When machining programs exist in the 2nd part system, they are simultaneously displayed in the deselected editing area. (*1) For 3-program simultaneous editing, machining programs in the 2nd and the 3rd part systems are simultaneously displayed in the deselected editing areas. (*1) When no machining programs exist in the 2nd part system, the machining programs opened in the deselected editing area are closed. (*1)
OFF (Collectively creates new machining programs in all the part systems.)	When no machining programs exist in all the part systems, a machining program in the 1st part system is displayed in the currently selected editing area and a machining program in the 2nd part system is displayed in the deselected editing area simultaneously. (*1) For 3-program simultaneous editing, machining programs in the 2nd and the 3rd part systems are simultaneously displayed in the deselected editing areas. (*1) When the machining programs in the 2nd part system exist, the message "Designated file already exists" appears and the file cannot be opened. (*1)

(*1) For part systems other than the 1st part system, the 2nd or the 3rd part system is described as a typical one.

Operation to automatically open the searched machining program (When the 1st part system is set as the displayed part system)

<For 2-program simultaneous editing>

Currently selected editing area	Deselected editing area	Operation
A machining program is not opened.	A machining program is not opened.	A machining programs in the 1st part system is displayed in the currently selected editing area, and that in the 2nd part system is simultaneously displayed in the deselected editing area. (*1)

For the conditions other than the above, no operation is performed.

<For 3-program simultaneous editing> (15-type/19-type)

Currently selected editing area	Deselected editing area 1	Deselected editing area 2	Operation
A machining program is not opened.	A machining program is not opened.	A machining program is not opened.	The currently selected editing area shows a machining program of the 1st part system. The deselected editing areas show machining programs in ascending order of the part systems from the left.

For the conditions other than the above, no operation is performed.

(*1) For part systems other than the 1st part system, the 2nd or the 3rd part system is described as a typical one.

Note

- (1) If the searched machining program is not registered in the displayed part system, it is not opened. When the searched machining program is registered only in the displayed part system, no file is opened in the deselected editing area.

Operation method (Opening the existing machining programs of the same name in all part systems (When the 1st part system is set as the displayed part system))

Perform the following procedure to open the machining program, "100", under the following conditions.

- The parameter "#8977 Multi-\$ simul edit" is set to "1" (valid).
- The machining program, "100", is registered in all part systems of NC memory.

(1) Press the menu [Open].  The list appears as a pop-up window.

(2) Use the [↑], [↓], [←], and [→] keys to align the cursor with the target machining program (100), and press the [INPUT] key.  The machining program "100" in the 1st part system is displayed in the currently selected editing area, and the machining program "100" in the 2nd part system is displayed in the deselected editing area.

The same operation can also be performed by inputting the machining program name (100) to be edited in the input section and pressing the [INPUT] key.

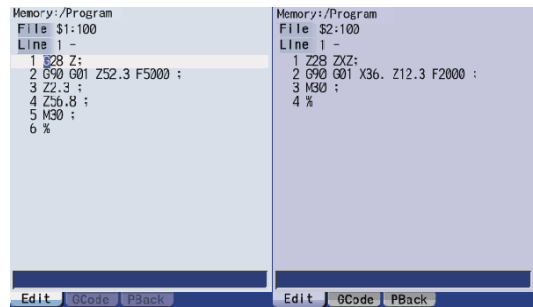

Operation method (Opening the existing machining programs of the same name in the 1st and 4th part systems (When the 1st part system is set as the displayed part system))

Perform the following procedure to open the machining program, "200", under the following conditions.

- The parameter "#8977 Multi-\$ simul edit" is set to "1" (valid).
- The machining program, "200", is registered in the 1st and 4th part systems of NC memory.

(1) Press the menu [Open].  The list appears as a pop-up window.

(2) Use the [↑], [↓], [←], and [→] keys to align the cursor with the target machining program (200), and press the [INPUT] key.  The machining program "200" in the 1st part system is displayed in the currently selected editing area, and the machining program "200" in the 4th part system is displayed in the deselected editing area.

The same operation can also be performed by inputting the machining program name (200) to be edited in the input section and pressing the [INPUT] key.

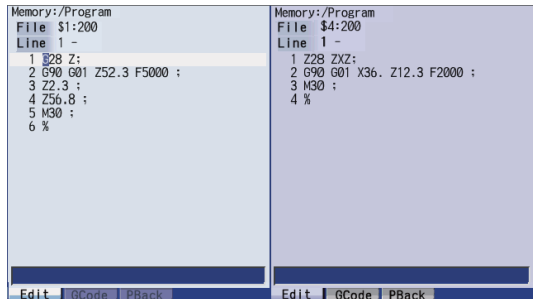

Operation method (Opening the existing machining programs only in the 1st part system (When the 1st part system is set as the displayed part system))

Perform the following procedure to open the machining program, "300", under the following conditions.

- The parameter "#8977 Multi-\$ simul edit" is set to "1" (valid).
- The machining program, "300", is registered in the 1st part system of NC memory.

(1) Press the menu [Open].



The list appears as a pop-up window.

(2) Use the [↑], [↓], [←], and [→] keys to align the cursor with the target machining program (300), and press the [INPUT] key.



The machining program "300" in the 1st part system is displayed in the currently selected editing area, and the machining program opened in the deselected editing area is closed.

The same operation can also be performed by inputting the machining program name (300) to be edited in the input section and pressing the [INPUT] key.

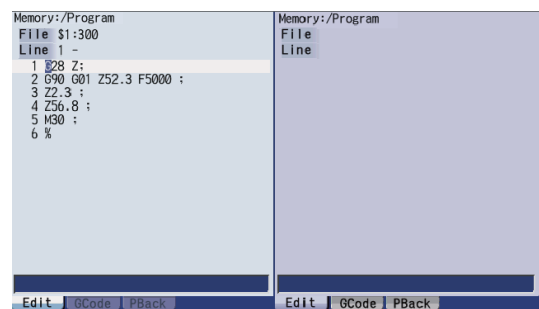
**Operation method (Opening the existing machining programs only in the 3rd part system (When the parameter "#1285 ext21/bit2" is set OFF and the 1st part system is set as the displayed part system))**

Perform the following procedure to open the machining program, "400", under the following conditions.

- The parameter "#8977 Multi-\$ simul edit" is set to "1" (valid).
- The machining program, "400", is registered in the 3rd part system of NC memory.

(1) Press the menu [Open].



The list appears as a pop-up window.

(2) Use the [↑], [↓], [←], and [→] keys to align the cursor with the target machining program (400), and press the [INPUT] key.



The operation message "Create new file?(Y/N)" appears.

The same operation can also be performed by inputting the machining program name (400) to be edited in the input section and pressing the [INPUT] key.

(3) Press the [Y] key.



The machining program, "400", is newly created in the 1st part system.

The machining program "400" in the 1st part system is displayed in the currently selected editing area, and the machining program "400" in the 3rd part system is displayed in the deselected editing area.

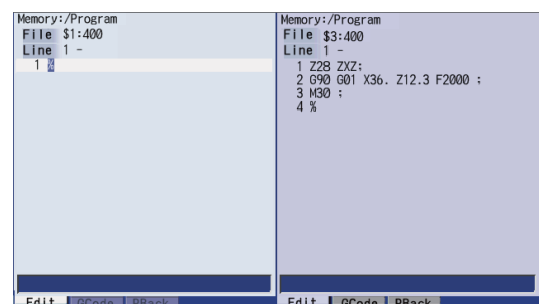

Operation method (Creating a new machining program (When the parameter "#1285 ext21/bit2" is set ON and the 1st part system is set as the displayed part system))

Perform the following procedure to create a new machining program, "500", under the following conditions.

- The parameter "#8977 Multi-\$ simul edit" is set to "1" (valid).
- The parameter "#1285 ext21/bit2" is set to "1" (to newly create only machining programs in the displayed part system).

- (1) Press the menu [Open(New)]. ➔ The list appears as a pop-up window.
- (2) Input the machining program name (500) to be newly created in the input section, then press the [INPUT] key. ➔ The machining program "500" in the 1st part system is displayed in the currently selected editing area, and the machining program opened in the deselected editing area is closed.

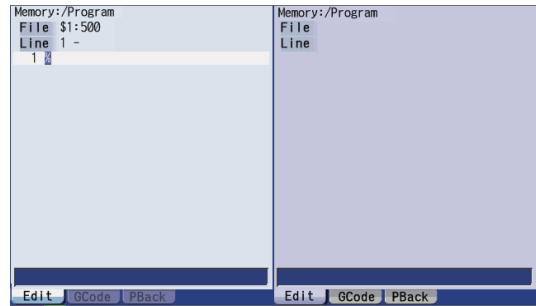

Operation method (Creating a new machining program (When the parameter "#1285 ext21/bit2" is set OFF and the 1st part system is set as the displayed part system))

Perform the following procedure to create a new machining program, "600", under the following conditions.

- The parameter "#8977 Multi-\$ simul edit" is set to "1" (valid).
- The parameter "#1285 ext21/bit2" is set to "0" (to collectively create new machining programs in all part systems).

- (1) Press the menu [Open(New)]. ➔ The list appears as a pop-up window.
- (2) Input the machining program name (600) to be newly created in the input section, then press the [INPUT] key. ➔ The machining program "600" in the 1st part system is displayed in the currently selected editing area, and the machining program "600" in the 2nd part system is displayed in the deselected editing area.

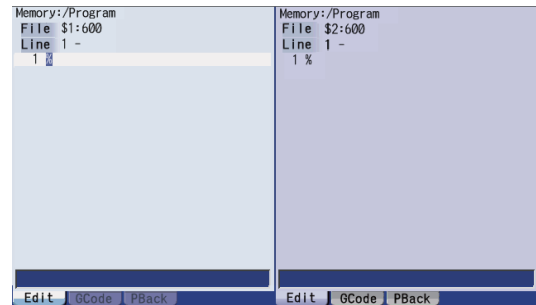

Operation to be performed when the menu [Open], [Open(New)], or [MDI] is pressed while editing a machining program

If the menu [Open], [Open(New)], or [MDI] is pressed during editing of a machining program while the parameter "#8977 Multi-\$ simul edit" is set to "1" (valid), whether to save both the contents of the currently selected editing area and those of the deselected editing area is confirmed regardless of whether the machining program to be opened actually is targeted for multi-part system simultaneous program editing.

Currently selected editing area	Deselected editing area	Operation
Not editing	Not editing	The operation of the pressed menu is performed.
Editing	Not editing	(1) The operation message "Save current file?(Y/N)" is displayed. (2) After any key has been pressed, the operation of the pressed menu is performed.
Not editing	Editing	(1) The message "Save right side file?(Y/N)" ("Save left side file?(Y/N)", "Save center file?(Y/N)") is displayed. (2) After any key has been pressed, the operation of the pressed menu is performed.
Editing	Editing	(1) The operation message "Save current file?(Y/N)" is displayed. (2) After any key has been pressed, the operation message "Save right side file?(Y/N)" ("Save left side file?(Y/N)", "Save center file?(Y/N)") is displayed. (3) After any key has been pressed, the operation of the pressed menu is performed.

3.8.2 Special Program Editing Display for Synchronization between Part Systems



Pressing the menu [Synchro view] enables synchronized display of the left- and right-side programs aligned when the following conditions are satisfied:

- The parameter "#1285 ext21/bit0" (Multi-part system program management) is set to "1" (valid).
- Multi-program display type is selected.
- The left and right edit areas are displaying the same named programs of different part systems stored on the NC memory.

Timing synchronization symbol includes "!", the synchronization M codes specified by the parameters (#1310 and #1311) and the MSTG codes specified by the definition files (created by the MTB), which can be used simultaneously.

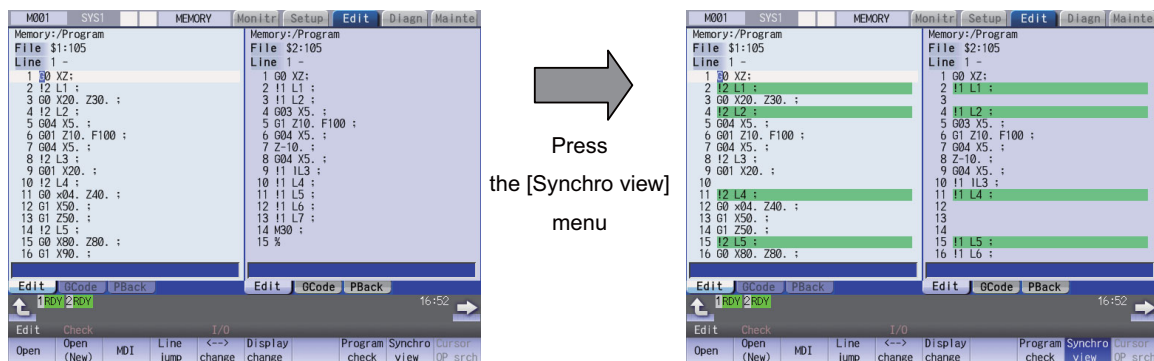
**Note**

- (1) The synchronous display is also available for MTB macro program and MDI.
- (2) Editing can be performed in the selected editing area, and the synchronous display is disabled when "Editing" is being displayed. The synchronous display becomes enabled again when the edited contents are determined.
- (3) Blank lines, which are inserted automatically to align the left- and right-side programs for the synchronization position, cannot be pasted with the menu [Paste] operation when the blank lines are specified as the copying range with the menu [Copy] operation.
- (4) The editable machining program size is up to 240 KB per part system.
 - When the menu [Synchro view] is pressed in the state where a machining program exceeding 240 KB is opened, the "Can't edit because of size over" message is displayed and the synchronous display cannot be performed.
 - When a file exceeding 240 KB is opened with [Synchro view] highlighted, the "Can't edit because of size over" operation message is displayed and the machining program cannot be opened.
- (5) The state where the [Synchro view] is highlight is held until the power is turned OFF and ON, a machining program for which the synchronous display is not available is opened, or the display type is changed to other than "Multi-program display type".
- (6) When the G code guidance, etc. is opened in the 3-program/4-program simultaneous display, the other two program edit areas show timing synchronization of the part systems.
- (7) If a timing synchronization symbol has no counterpart, the message "Can't display synchronous program" appears and the subsequent synchronous display is not performed.
- (8) Even when M code macro or M command synchronous tapping is overlapped with M codes specified by the parameters (#1310 and #1311) or definition files, the synchronous display is available.
- (9) If the synchronization M code specified by the parameter is not described in a single block, it is not treated as timing synchronization symbol.
- (10) Even when the parameters (#19419, #1310 or #1311) are changed while the menu [Synchro view] is highlighted, re-synchronization is not performed. To reflect the change of the parameters, the menu [Synchro view] needs to be highlighted again.
- (11) On the synchronous display with the menu [Synchro view], "L" (synchronization No.) which follows the synchronization symbol "!" cannot be displayed. Thus, the different "L" (synchronization No.) may be displayed synchronously on the 4-program simultaneous display screen.

3 Inputting a Machining Program and Defining Variables

[Display during synchronous view]

Memory:/Program
File \$1:106
Line 1 -
1 G0 XZ ;
2 I2 L1 ;
3 G0 X20. Z30. ;
4 I2 L2 ;
5 G04 X5. ;
6 G01 Z10. F100 ;
7 G04 X5. ;
8
9
10
11 I2 L3 ;
12 G01 X20. ;
13 I2 L4 ;
14 G0 X04. Z40. ;
15 G1 X50. ;
16 G1 Z50. ;
Edit | GCode | PBack

Memory:/Program
File \$2:106
Line 1 -
1 G0 XZ ;
2 I1 L1 ;
3
4 I1 L2 ;
5 G03 X5. ;
6 G1 Z10. F100 ;
7 I1 ;
8 G04 X5. ;
9 Z-10. ;
10 G04 X5. ;
11 I1 L3 ;
12
13 I1 L4 ;
14
15
16
Edit | GCode | PBack

Blank lines are inserted to align the left- and right-side synchronization position.

Cursor line is not highlighted.

The line is displayed with the line No. includes blank lines.

The line with the timing synchronization symbols is highlighted (with green color).

The line with the timing synchronization symbol which does not have the synchronizing target is not highlighted.

Memory:/Program
File \$1:1000
Line 1 -
1 G0 XZ ;
2 I2 L1 ;
3 G0 X20. Z30. ;
4 I2 L2 ;
5 G04 X5. ;
6 I2 L3 ;
7 G01 X20. ;
8 I2 L4 ;
9 G0 X04. Z40. ;
10 G1 X50. ;
11 G1 Z50. ;
12 I2 L5 ;
13 ;
14 %
Edit | GCode | PBack

Memory:/Program
File \$2:1000
Line 1 -
1 G0 XZ ;
2 I1 L1 ;
3
4 I1 L2 ;
5 G03 X5. ;
6 G01 Z10. F100 ;
7 I1 ;
8 G04 X5. ;
9 I1 L3 ;
10 G01 X20. ;
11 I1 L4 ;
12 G0 X04. Z40. ;
13 G1 X50. ;
14 G1 Z50. ;
15 I1 L5 ;
16 ;
17 %
Edit | GCode | PBack

Lines after the one where the error is displayed, do not show the synchronous display.

The line with the timing synchronization symbols is highlighted (with green color).

Since the line does not have the synchronizing target, the message "Can't display synchronous program." is displayed.

3.9 Inserting Cycle Interactively



This function enables you to interactively insert a cycle that assists machining and setup for the program opening on the edit screen.

The programming time can be reduced by using this function.

The cycle can be easily inserted by editing the data on the interactive window.

[Operation image of cycle insertion]

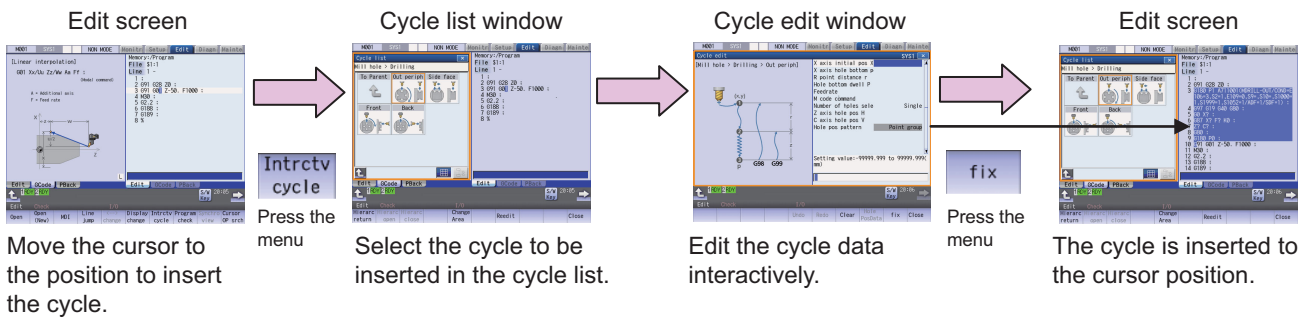

Once you insert a cycle block, you can edit it directly on the program edit screen, or re-edit it in the cycle edit window if the cycle format is not changed.

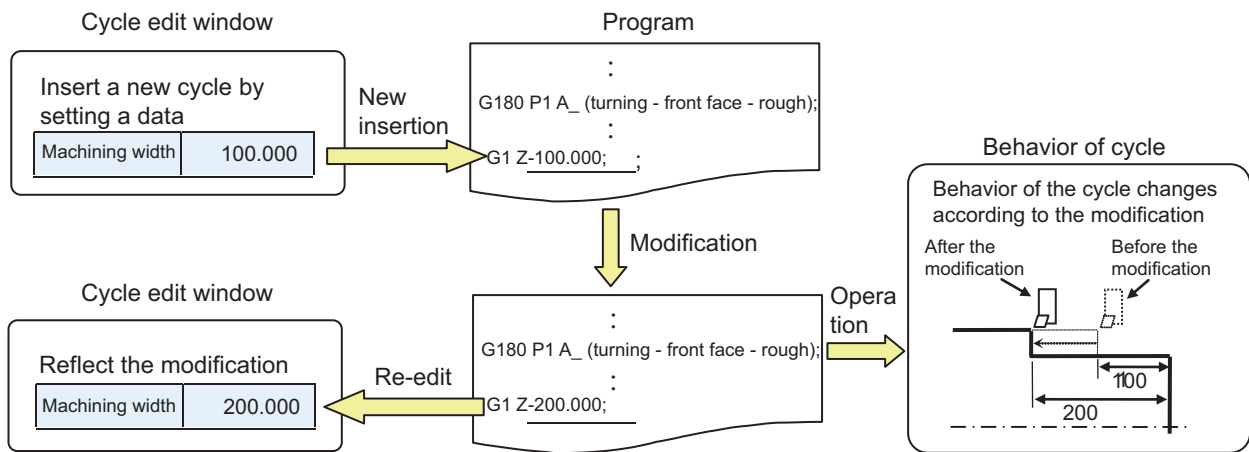

3.9.1 Types of Cycle

Machining cycle can be inserted.

Cycle for lathe system or cycle for machining center system can be selected according to the NC system set with the parameter "#1007 System type select".

For cycle types, there are "Normal type" and "Extend type" of MITSUBISHI cycle and arbitrary cycle "Custom type" prepared by MTB.

Select the menu [Normal], [Extend] or [Custom] on the interactive cycle insertion screen. Select a cycle type you want to change and switch the cycle on the displayed cycle list window.

■Cycles for lathe system

○: Cycle insertion available

-: No specification

Hierarchy 1	Hierarchy 2	Hierarchy 3	Standard type	Expansion type
Cycle type	Machining cycle	Machining portion		
Turning hole	Drill	Front	○	○
	Deep-hole drilling	Back	○	○
	Tapping		○	○
	Deep-hole tapping		○	○
	Reaming		-	○
	Boring		○	○
Turning	Turning	Outer diameter	○	○
	Turning (compound)	Inner diameter	○	○
	Copying	Front	○	○
	Grooving	Back	○	○
	Cutting-off		○	○
	Thread cutting	Outer diameter	○	○
	Thread cutting (compound)	Inner diameter	○	○
	Thread recutting		○	○
	Thread recutting (compound)		○	○
Milling hole	Drill	Periphery	○	○
	Deep-hole drilling	Side	○	○
	Step drilling	Front	○	○
	Tapping	Back	○	○
	Deep-hole tapping		○	○
	Reaming		-	○
	Boring		○	○
Milling	Pocketing	Side	-	○
		Front		
	Grooving	Back	-	○

Note

- (1) For the standard type, there are two types of formats, normal format and MITSUBISHI CNC special format. It depends on the setting of the parameter "#1265 ext01" bit0 to bit2 which format is to be selected.
- (2) The fixed cycle is used for "Tapping" and "Deep-hole tapping" for the expansion type. Same as the standard type, it depends on the setting of the parameter "#1265 ext01/bit2" which format is to be selected.

■Cycles for machining center system

○: Cycle insertion available -: No specification

Hierarchy 1 Cycle type	Hierarchy 2 Machining cycle	Standard type	Expansion type
Hole	Drill	○	○
	Deep-hole drilling	○	○
	Step drilling	○	○
	Tapping	○	○
	Deep-hole tapping	○	○
	Reaming	-	○
	Boring	○	○
Milling	Plane	-	○
	Pocketing	-	○
	Grooving	-	○
	Contour	-	○

Note

(1) The fixed cycle is used for "Tapping" and "Deep-hole tapping" for the expansion type.

■Display of cycle list window

The cycle list window is displayed in the area opposite to editing area. For the cycle list window, there are "Image display type" and "Tree display type", which can be switched with change list button.

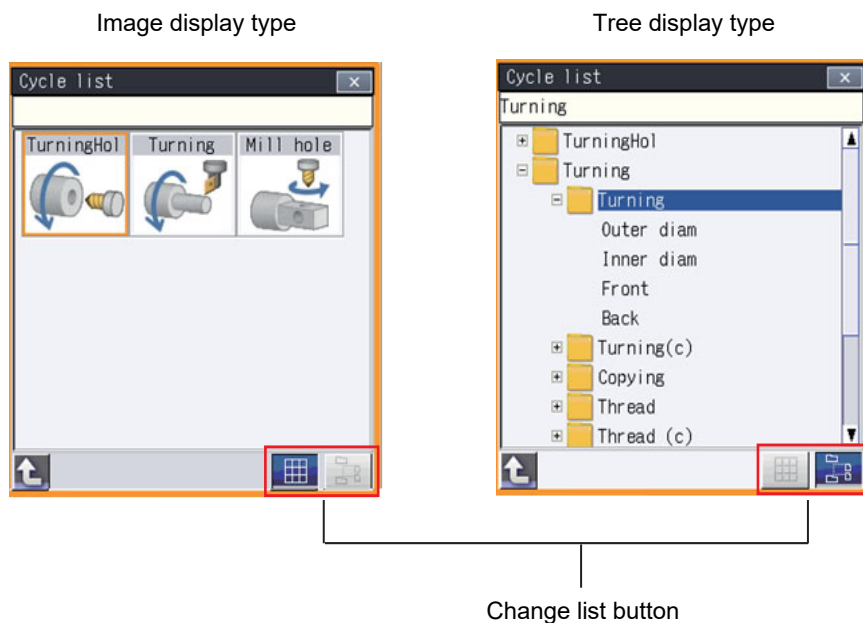

3.9.2 Name of Data

Names and meanings of data related to cycle are indicated as follows:

- Arbitrary shape data: Data to set the arbitrary shape

<Example of turning - outer diameter>

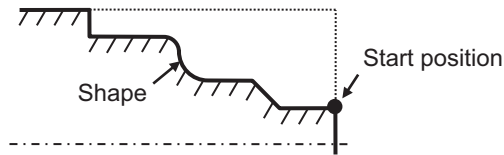

- Machining data: Data to specify the machining method as cutting depth and finishing allowance

<Example of turning cycle>

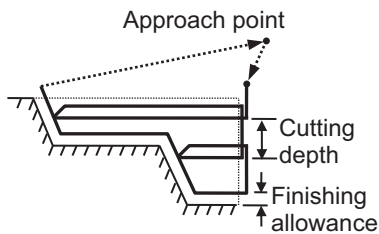

<Example of drilling cycle>

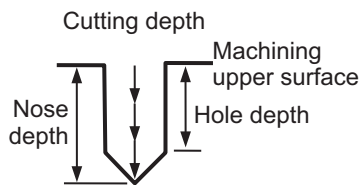

<Example of milling cycle>

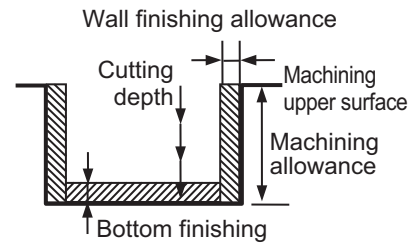

- Hole position data: When multi-drilling is performed, this is the data to specify the hole position.

<Example of straight line hole position>

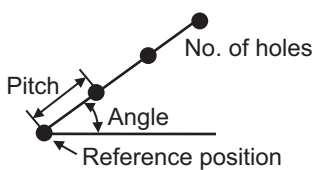

<Example of rectangle hole position>

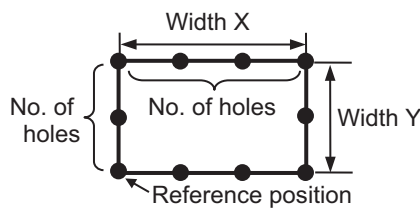

<Example of circle hole position>

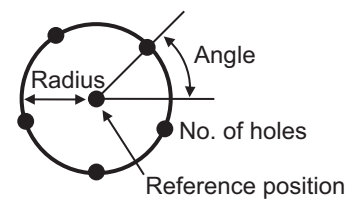

There are the following combinations for the data to set depending on the cycle types.

- Machining data only
- Machining data + Arbitrary shape data
- Machining data + Hole position data

Refer to the section "3.9.3 Screen Configuration" for the data edit window.

3.9.3 Screen Configuration

Screen configuration of this function is as follows:

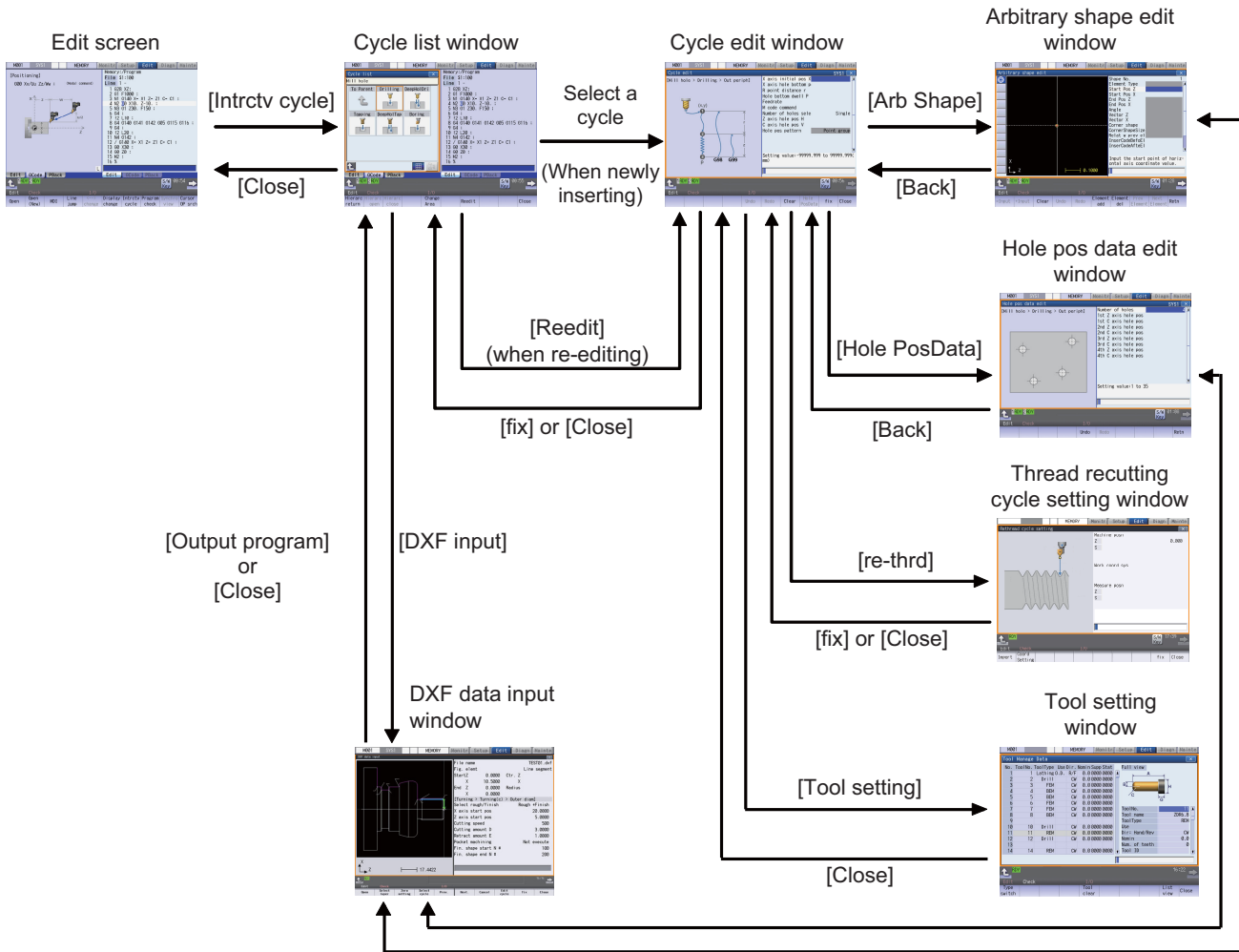

Screen/window	Details
Edit screen	This is a screen to edit the program. To insert or re-edit the cycle, press the menu [Intrctv cycle] on this screen.
Cycle list window	This is a window to select the cycle to be inserted.
Cycle edit window	This is a window to edit machining data of the cycle.
Arbitrary shape edit window	This is a window to edit arbitrary shape data of the cycle.
Hole pos data edit window	This is a window to edit hole position data of the cycle.
Thread recutting cycle setting window	When you are going to perform thread recutting for a machining completed workpiece, this is the window to read the measured thread groove position.
DXF data input window (*1)	This is a window to edit arbitrary shape data/hole position data of the cycle using DXF drawing file.
Tool management window	This is a window to set and display the tool information to be used for machining.

(*1) DXF data input function is a support for the interactive cycle insertion.

The function allows you to import a DXF drawing file from an external I/O device through DXF data input window and extract the figure element data from the drawing. And add them as arbitrary shape data or as hole position data to the cycle being edited using the interactive cycle insertion function.

3.9.4 Operation Descriptions

Inserting a new cycle program

In the program being opened on the edit screen, move the cursor to the position where you want to insert new cycle. Press the menu [Intrctv cycle] to select the cycle, and edit and insert it. The cycle is inserted before the block where the cursor is located in the program being opened on the edit screen.

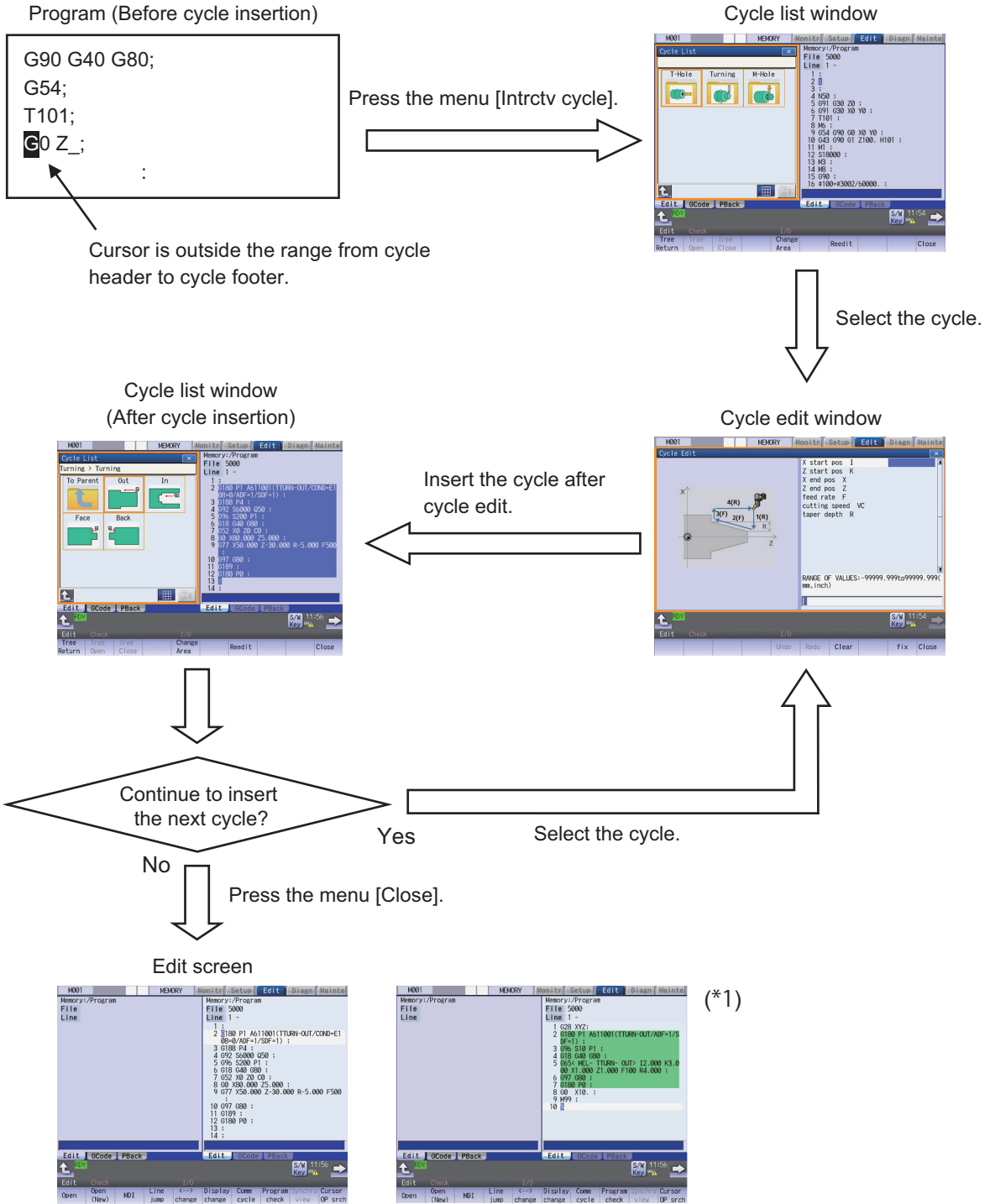

After the cycle insertion, the screen returns to the cycle list window in the cycle inserted state. The inserted cycle is highlighted in the editing area of the program, and the cursor moves to the head of the next line of the cycle. Then, the program is saved.

(*1) The block from cycle header to cycle footer can be highlighted with the parameter setting. For details, refer to "3.9.6 Highlighting the Cycle Program".

Reediting the cycle program

In the program being opened on the edit screen, move the cursor within the range from cycle header (G180P1 block) to cycle footer (G180P0 block) of the cycle that you want to reedit. Press the menu [Intrctv cycle] and then [reedit] in this condition, existing cycle can be reedited.

Program (Before cycle reedit)

```
G90 G40 G80;
G54;
T101;
G180 P1 A10101 (THREAD-OUT);
G97 S500 M3;
M8;
G65 P<THREAD> A30. B10. ...;
M9;
M5;
G180 P0;
G0 Z-10.;
:
```

Press the menu [Intrctv cycle].

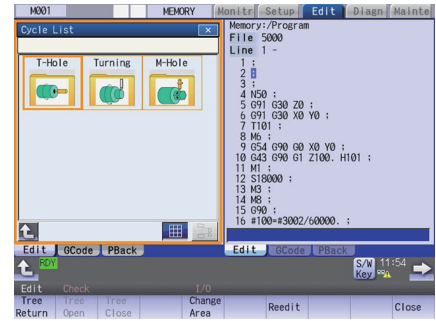
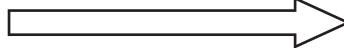

Press the menu [Reedit].

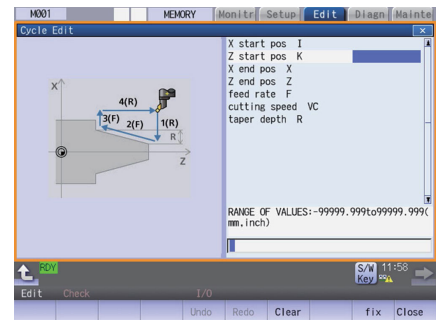

Program (after cycle reedit)

```
G90 G40 G80;
G54;
T101;
G180 P1 A10101 (THREAD-OUT);
G97 S800 M3;
M8;
G65 P<THREAD> A50. B10. ...;
M9;
M5;
G180 P0;
G0 Z-10.;
:
```

Insert the cycle after reedit the cycle.

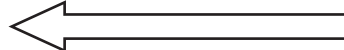

Details of the cycle are changed.

After reediting the cycle, the screen returns to the cycle list window in the state that the reedit results were reflected to the cycle. The inserted cycle is highlighted in the editing area of the program, and the cursor moves to the head of the next line of the cycle. Then, the program is saved.

3.9.5 Operation Procedure

The chart below indicates the operation procedure of cycle insertion and reediting.

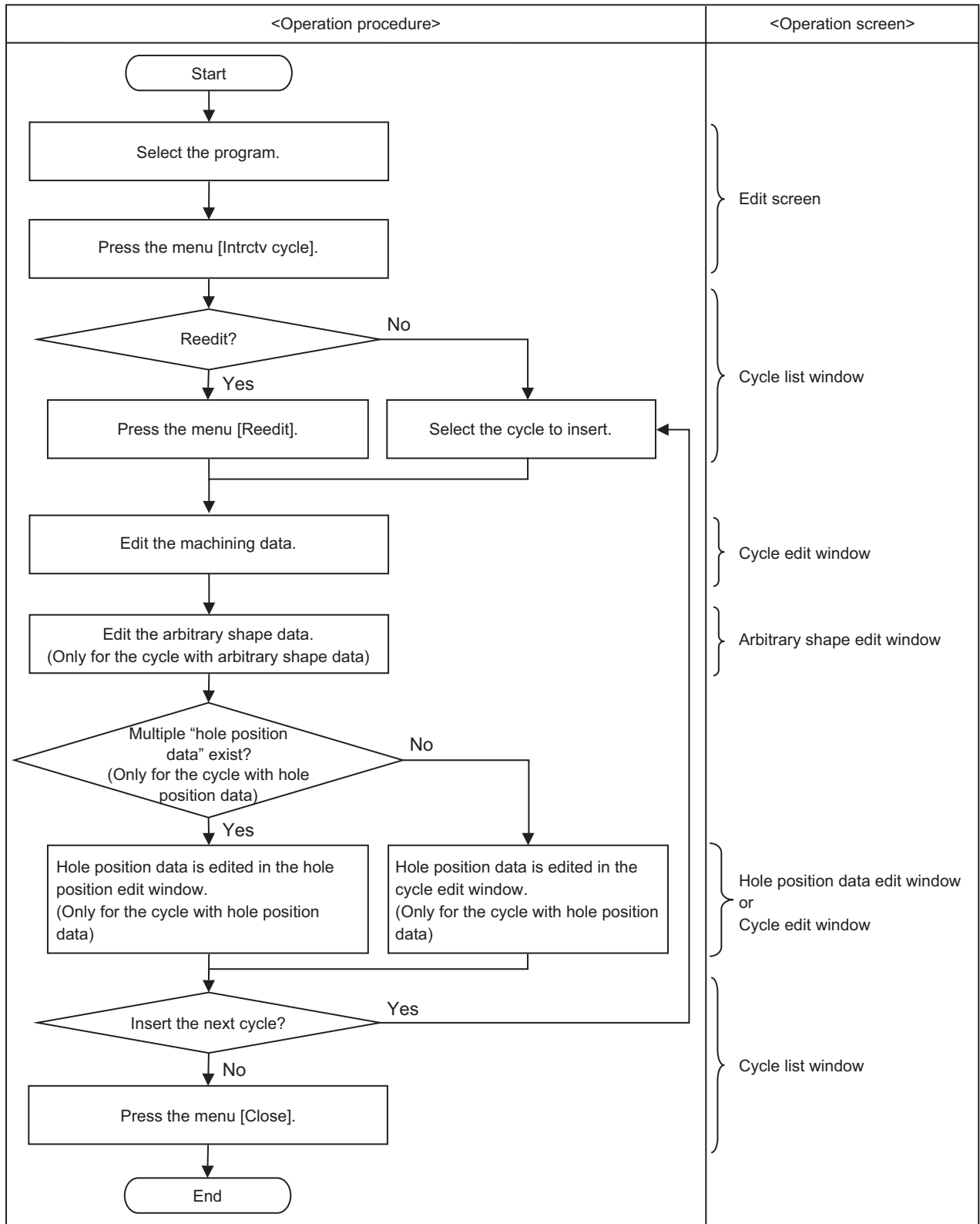

3.9.6 Highlighting the Cycle Program

When the parameter "#8993 Cycle highlight" is set to "1", the blocks from cycle header (G180P1) to cycle footer (G180P0) are highlighted. The block where the cycle is inserted can be distinguished easily by using this function.

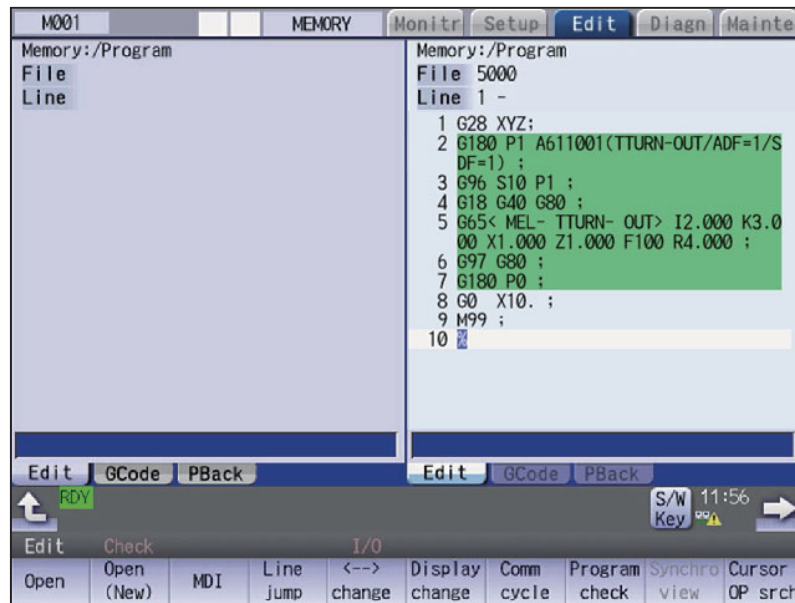

Note

- (1) When the set of cycle header and cycle footer does not exist within 200 blocks above and below from the first line of the display area, the block is not highlighted.
- (2) The highlighted display is not updated while the program is being edited.
- (3) The highlighting function does not perform the format check of the cycle. Therefore, even in the highlighted block, it may not be possible to re-edit the cycle.

3.10 Defining Variables

Refer to "Programming Manual" for more details on variables.

3.10.1 Common Variables



Select [Com var] on the monitor (Monitr) screen to set or display the details of the common variables.

If there is a common variable command (*1) in the machining program, the variable value (variable name) set when the block is executed is displayed.

The number of common variable sets differs according to the specifications.

(*1) The variable names can be set for common variables #500 to #599.

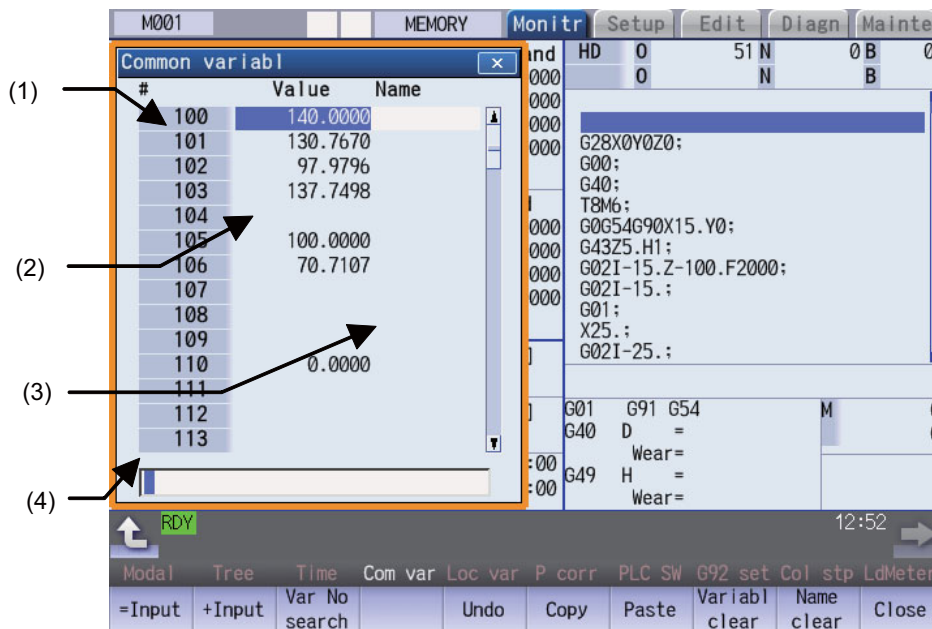

Display items

Display items	Details																								
(1) Variable number	<p>This is the common variable No. There are common variable 1 (common to part systems) and common variable 2 (for each part system) (Refer to the table below). The #100 variables appear at the head when the power is turned ON. If "#1052 MemVal" is set to "1" (Designate No. of common variable common to part systems), "*" is attached to the variable that is common to part systems. (Note that if there is only one part system, "*" will not appear.)</p> <table border="1"> <thead> <tr> <th>Part system</th> <th>Number of sets</th> <th>Common variable 1 (common to part systems)</th> <th>Common variable 2 (for each part system)</th> </tr> </thead> <tbody> <tr> <td rowspan="4">One part system</td> <td>200 sets</td> <td>500 to 599</td> <td>100 to 199</td> </tr> <tr> <td>600 sets</td> <td>500 to 999 100100 to 800199 (*2)</td> <td>100 to 199</td> </tr> <tr> <td>700 sets</td> <td>400 to 999 (*1) 100100 to 800199 (*2)</td> <td>100 to 199</td> </tr> <tr> <td>8000 sets</td> <td>400 to 999 (*1) 100100 to 800199 (*2) 900000 to 907399 (*3)</td> <td>100 to 199</td> </tr> <tr> <td rowspan="2">Multi-part system (n = number of part systems)</td> <td>600+100×n set(s)</td> <td>400 to 999 (*1) 100100 to 800199 (*2)</td> <td>100 to 199 ×n</td> </tr> <tr> <td>7900+100×n set(s)</td> <td>400 to 999 (*1) 100100 to 800199 (*2) 900000 to 907399 (*3)</td> <td>100 to 199 ×n</td> </tr> </tbody> </table>	Part system	Number of sets	Common variable 1 (common to part systems)	Common variable 2 (for each part system)	One part system	200 sets	500 to 599	100 to 199	600 sets	500 to 999 100100 to 800199 (*2)	100 to 199	700 sets	400 to 999 (*1) 100100 to 800199 (*2)	100 to 199	8000 sets	400 to 999 (*1) 100100 to 800199 (*2) 900000 to 907399 (*3)	100 to 199	Multi-part system (n = number of part systems)	600+100×n set(s)	400 to 999 (*1) 100100 to 800199 (*2)	100 to 199 ×n	7900+100×n set(s)	400 to 999 (*1) 100100 to 800199 (*2) 900000 to 907399 (*3)	100 to 199 ×n
Part system	Number of sets	Common variable 1 (common to part systems)	Common variable 2 (for each part system)																						
One part system	200 sets	500 to 599	100 to 199																						
	600 sets	500 to 999 100100 to 800199 (*2)	100 to 199																						
	700 sets	400 to 999 (*1) 100100 to 800199 (*2)	100 to 199																						
	8000 sets	400 to 999 (*1) 100100 to 800199 (*2) 900000 to 907399 (*3)	100 to 199																						
Multi-part system (n = number of part systems)	600+100×n set(s)	400 to 999 (*1) 100100 to 800199 (*2)	100 to 199 ×n																						
	7900+100×n set(s)	400 to 999 (*1) 100100 to 800199 (*2) 900000 to 907399 (*3)	100 to 199 ×n																						
(2) Variable value	<p>The setting range is -999,999,999 to 999,999,999 or blank. An exponential is displayed when 7 digits are set in the integer section and 5 digits or more are set in the decimal section. (Example) 1234567 -> 1.2346E+006, 0.00001 -> 1.0000E-005 The minimum setting unit that can be set is 1.0000E-099 (99 digits below decimal point). <Note> •When the setting is "blank", the setting will be handled as "0" in the calculations. However, when the conditional expressions EQ or NE are used, the blank will not be handled as "0". •Common variables protected by the parameters #12111 to #12114 are unable to be set.</p>																								
(3) Variable name	<p>A variable name can be assigned for #500 to #599. Two-byte characters such as Chinese character can be displayed, however, only symbols and alphanumeric characters can be input on the screen. The maximum number of one-byte characters is 10. <Note> •Common variables protected by the parameters #12111 to #12114 are unable to be set.</p>																								
(4) Input section	This displays details of the key input.																								

(*1) Address #400s common variable can be used only when the sets of common variable is "700 sets or more" and the parameter "#1336 #400_Valtype" is "1".

3 Inputting a Machining Program and Defining Variables

(*2) When the parameter "#1316 CrossCom" is set to "1", the common variables #100100 to # 800199 can be used common to part systems. The variables shown in the table below can be used common to part systems.

Common variables 1 (When "#1316 CrossCom" = "1")	
#100100 to #100199	Equivalent to # 100 to #199 in 1st part system
#200100 to #200199	Equivalent to # 100 to #199 in 2nd part system
#300100 to #300199	Equivalent to # 100 to #199 in 3rd part system
#400100 to #400199	Equivalent to # 100 to #199 in 4th part system
#500100 to #500199	Equivalent to # 100 to #199 in 5th part system
#600100 to #600199	Equivalent to # 100 to #199 in 6th part system
#700100 to #700199	Equivalent to # 100 to #199 in 7th part system
#800100 to #800199	Equivalent to # 100 to #199 in 8th part system

(*3) When the parameter "#1052 MemVal" is set to "1", you cannot use the variables #900000 to #907399 that are available when the specification "8000 sets of variables" is enabled.



Menus

Menus	Details
=Input	This executes an absolute input. If "#8930 Disable=INPUT:var" is set to "1", this menu cannot be selected.
+Input	This executes an incremental input.
Var No search	This designates the variable No. to be displayed at the head. Common variable 1 (common to part systems) #400 to #999, common variable 1 (common to part systems) #100100 to #800199, and common variable 2 (for each part system) #100 to #199 are displayed in each area. When another area is displayed, press this menu and specify the common variable No.
Move window	This moves the display position of the common variable window.
Undo	This returns the last rewritten data to its previous value. This menu key is valid for "Data Input", "Paste" and "Undo" operations. Note that return to the original value is not possible after variable clear and comment clear operations. <Note> •When the parameter "#8939 Undo confirm msg" is set to "1", the menu is highlighted while the operation message is displayed.
Copy	This copies the variable value and variable name at the cursor position.
Paste	This pastes the copied variable value and variable name.
Variabl clear	This clears the variable value(s) at the cursor position or in the designated range. <Note> •The contents are not cleared to "0". The state with no data is entered. •Common variables protected by the parameters #12111 to #12114 are unable to be cleared.
Name clear	This clears the variable name(s) at the cursor position or in the designated range. <Note> •Common variables protected by the parameters #12111 to #12114 are unable to be cleared.
Close	This closes the pop-up window and quits this function.

Operation method (Setting "135.000" in variable No. 102)

(1) Press the menu [Var No search].

(2) Designate the variable No.
102 [INPUT]

The cursor can be moved to 102 using the [↑], [↓], , or  key.

(3) Input a numeric value.
135 [INPUT]

The value can also be designated by pressing the menu [=Input] instead of the [INPUT] key.

The value can also be input as an exponential.

(1.35E2 [INPUT] or 1.35E2 [=Input].)

Operation method (Adding "1.234" to variable No. 102)

(1) Select common variable 102 with the same procedure as steps (1) and (2) above.

(2) Input a numeric value.
1.234 [+Input]



The input value added to the original value is displayed.
(Example) If the original value is 135.000, 136.234 appears. (135.000 + 1.234 = 136.234)

Operation method (Setting "COUNTER" as the variable name for variable No. 509)

(1) Select common variable 509 with the same procedure as steps (1) and (2) above.

(2) Press the  key.

(3) Input the variable name.
COUNTER [INPUT]



Note

(1) The variable name can be set only for variable No. 100 to 199 or 500 to 599.

Operation method (Copying and pasting the common variable)

(1) Select the variable to be copied.

One of the following methods can be used to select the variable.

- Using the cursor movement key [↑], [↓], , or , move the cursor to the variable to be selected.
- Press [Var No search] and set the variable No. in the input area, and press the [INPUT] key.

(2) Press the menu [Copy].

(3) Select the variable to be pasted, and press the menu [Paste].
The copied variable is held until a variable is newly copied.

Operation method (Erasing the variable value for variable number 102 to 104)

- (1) Press the menu [Variabl clear].
- (2) Input the No. (range) of the variable to be erased.
102/104 [INPUT]
To erase only one variable, input one variable No.
(102 [INPUT])
- (3) Press the [Y] key.

Note

- (1) The variable at the cursor position will become the target of the erasing if the [INPUT] key is pressed without designating a variable No.
- (2) The variables in the range below are the erasing target when /E is designated.

Input example	Erasing range	Supplement
100/E	100 to 199 100100 to 100199 (when the displayed part system is 1)	Only common variable in the displayed part system is cleared.
400/E	400 to 999 100100 to 800199 900000 to 907399	Range to be cleared varies depending on the number of common variable sets.

- (3) If you include a variable between 100s and 500s in the range designation, the erasing is not performed. (Example) When you set "110/510", "setting error" is displayed and the variables are not erased.
- (4) When the variables protected in the parameters #12111 to #12114 are included, the erasing is performed excluding the protected variables. When the whole range designated by the variables clear is within the protected range, "setting error" is displayed.

Operation method (Erasing the variable name for variable No. 509)

- (1) Press the menu [Name clear].
- (2) Select the variable , and press the [INPUT] key.
509 [INPUT]
- (3) Press the [Y] key.



The variable name for 509 only is erased.
The variable value is not erased.

Note

- (1) The variable at the cursor position will become the target of the erasing if the [INPUT] key is pressed without designating a variable No.
- (2) The variables in the range below are the erasing target when /E is designated.

Input example	Erasing range	Supplement
100/E	100 to 199	Only variable name in the displayed part system is cleared.
500/E	500 to 599	

- (3) Variable names protected in the parameters #12111 to #12114 are not erased.

Switching the variable No.



Methods to switch the display areas are as follows.

- (1) Use the menu [Var No search].
- (2) Use the page up/down keys.
 - If you press the next page key during displaying the last page of the area, the first page of the next area will be displayed.
 - If you press the previous page key during displaying the first page of the area, the last page of the previous area will be displayed.
(Example) If you press the next page key during displaying the last page of the common variable 2 (for each part system) (#100 -), the first page of the common variable 1 (common to part systems) (#500 -) will be displayed.
- (3) Use a cursor key
 - When a cursor key is placed at the biggest variable No. in the area, the first page in the next area will be displayed by pressing [↓] or [→].
 - When a cursor key is placed at the first variable No. in the area, the biggest variable No. in the previous area will be displayed at the top by pressing [↑] or [←].
- (4) Use a scroll bar
 - The first page of the next area will be displayed by pressing ▼, while the last page of the area is displayed.
 - The biggest variable No. in the previous area is displayed at the head by pressing ▲, while the first page is displayed.

Variable numbers cannot be displayed continuously if another display area is inserted in between.

Switching the window display position

Press the menu [Move window] to change the currently displayed window position.

- | | | |
|------------------------------------|---|--|
| (1) Press the main menu [Com var]. |  | The common variable window is displayed in the pop-up window on the left of the screen. |
| (2) Press the menu [Move window]. |  | The common variable window will be move to the right.
The window position will be switched every time the [Move window] is pressed. |

3.10.2 Local Variables



Select [Loc var] on the monitor (Monitr) screen, and the details of the local variables are displayed.

Local variables 1 to 33 are prepared for each user macro subprogram call level. Up to 33 local variable data items are displayed on one level. A 5-level configuration from level 0 to level 4 is used in page order. If there is a local variable command or an argument designation called by the user macro subprogram in the block, and that block is executed first, the set variable value (variable name) will be displayed.

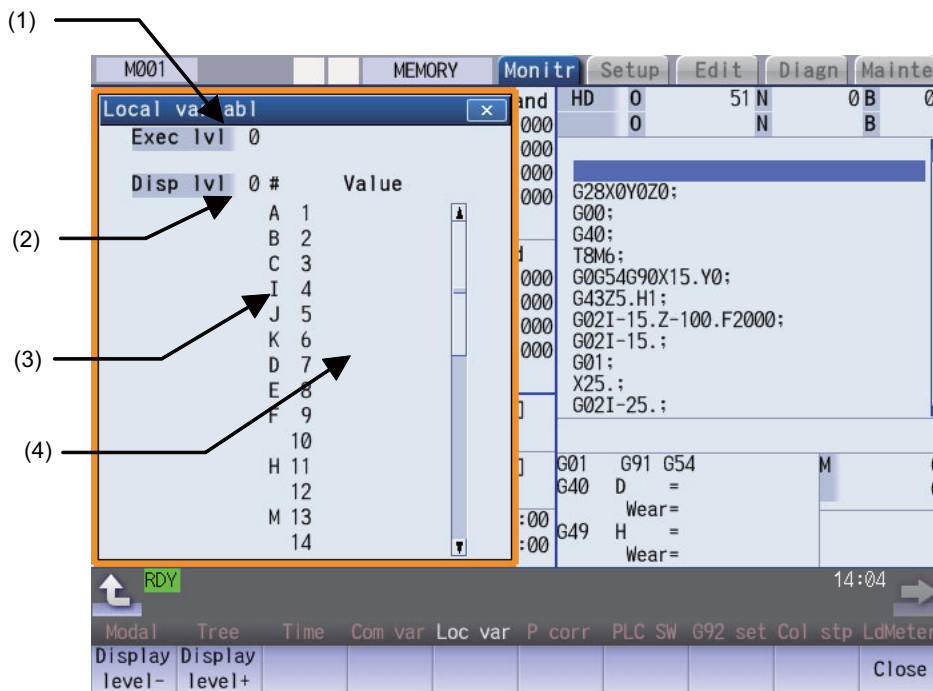

Display items

Display items	Details
(1) Execution level	This displays the nest level of the subprogram control called by the user macro. 0: Not in user macro call state 1: User macro call level 1 2: User macro call level 2 3: User macro call level 3 4: User macro call level 4
(2) Display level	This displays the nest level of the local variable displayed in the area.
(3) Variable number	This displays the local variable No. The alphabetic character before the local variable No. is the argument code. G, N, O cannot be used as arguments, and thus not displayed. There are 33 local variables (1 to 33) for each user macro subprogram call level.
(4) Variable value	This displays the local variable value. If the variable data is "blank", the display will be blank. An exponential is displayed when a 7 digits are set in the integer section and 5 digits or more as set in the decimal section. (Example)1234567 -> 1.2346E+006, 0.00001 → 1.0000E-005 <Note> ♦When the setting is "blank", the setting will be handled as "0" in the calculations. However, when the conditional expressions EQ or NE are used, the blank will not be handled as "0".

Menus	
Menus	Details
Display level-	This lowers the local variable display level one by one. If this menu is pressed when the display level is 0, the level changes to display level 4.
Display level+	This increases the local variable display level one by one. If this menu is pressed when the display level is 4, the level changes to display level 0.
Close	This closes the pop-up window and quits this function.

Relation of user macro subprogram call execution level and display level

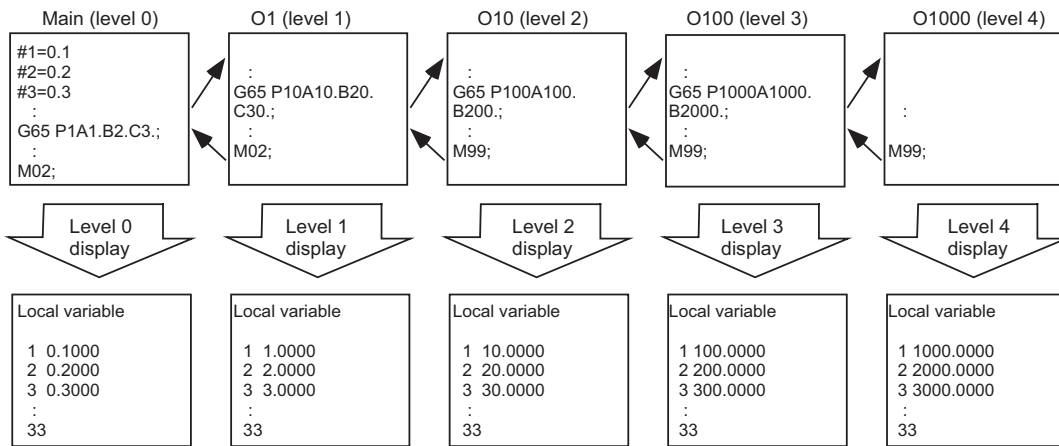

Precautions

The local variables are not erased when reset or when the power is turned OFF. They are erased at macro call.

Operation method (Displaying the next level)

When the current display level is 0

- (1) Press the menu [Display level +]. ➡ The level 1 local variables appear from the head.

When the menu [Display level +] is pressed again, the display level changes in the order of 2 -> 3 -> 4 -> 0 -> 1 -> 2 -> ... and so forth.

Operation method (Displaying the previous level)

When the current display level is 2

- (1) Press the menu [Display level -]. ➡ The level 1 local variables appear from the head.

When the menu [Display level -] is pressed again, the display level changes in the order of 0 -> 4 -> 3 -> 2 -> 1 -> 0 -> ... and so forth.

Operation method (Changing the displayed variable No.)

The displayed local variable No. changes when the page up/down keys (previous page , next page ) are pressed.

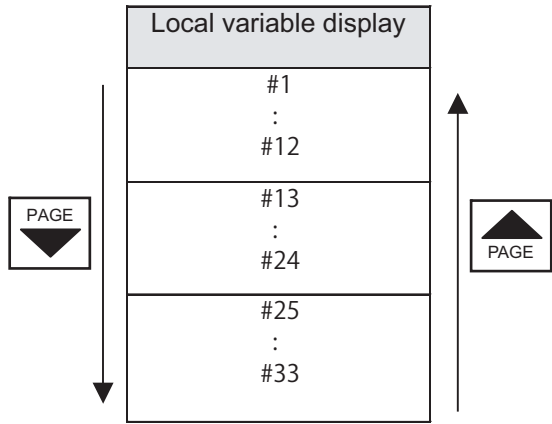

Checking a Machining Program on Screen

This chapter explains checking the machining program. Generally, operations are performed on the edit (Edit) and monitor (Monitr) screen.

4.1 Graphic Check (2D)



Graphic check (2D) is a function that allows you to check the machining program movement path only by drawing without automatic operations. Therefore, the graphics can be drawn at a high speed and high accuracy, and the machining program can be checked.

Press the menu [Check] on the monitor or edit screen to switch to the graphic check screen.

The graphic check screen allows you to check the currently displayed part system program. In the 2-part system or more, press the part system switch key  to switch the display to the target part system before starting checking.

Note that program check is carried out in the 2-part system or more regardless of the command such as the timing synchronization between a hidden part system and another part system.

Using the menu [All display], normal display and whole display modes can be switched.

Note

(1) When changing the screen to the edit screen, display depends on the previous checking type (2D/3D). If 3D graphic data appears, press the menu [2D check].

However, if the previous two-dimensional check screen is displayed during tracing, the display switches to the 2D check screen only when tracing is turned OFF after a message was displayed to check that tracing is turned OFF.

[Terms]

The following descriptions are the meanings of the terms used in this section.

Foreground: Active state operated by the user such as automatic operation on the NC

Background: Inactive state operated in the back of foreground

■ Normal display ([All display] is OFF)

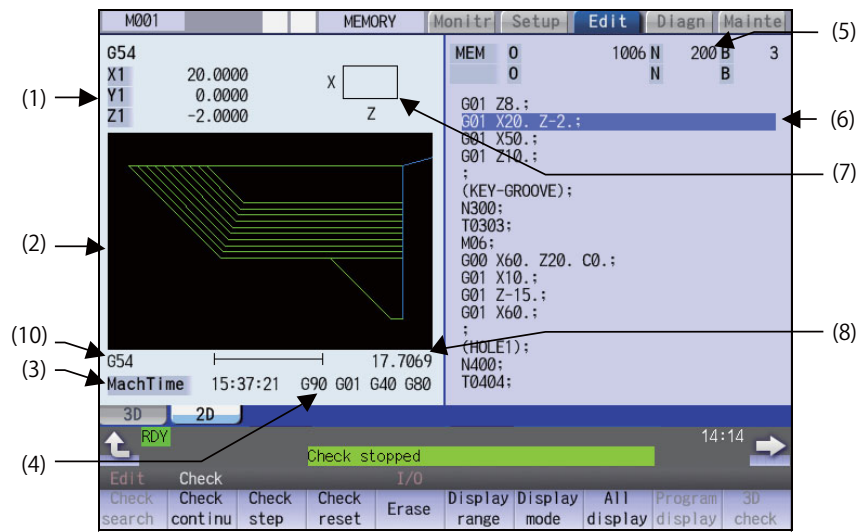

<Drawing area: 2-plane>

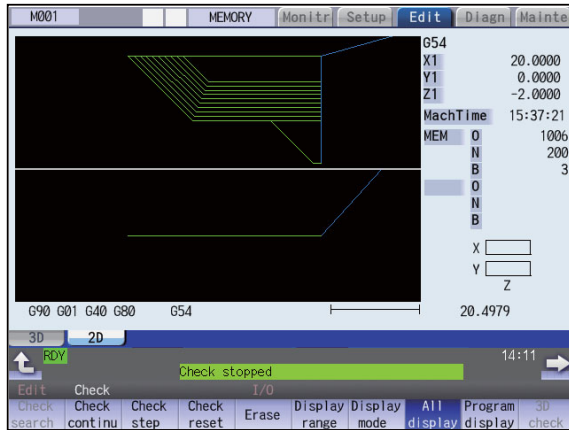

<Input area displayed>

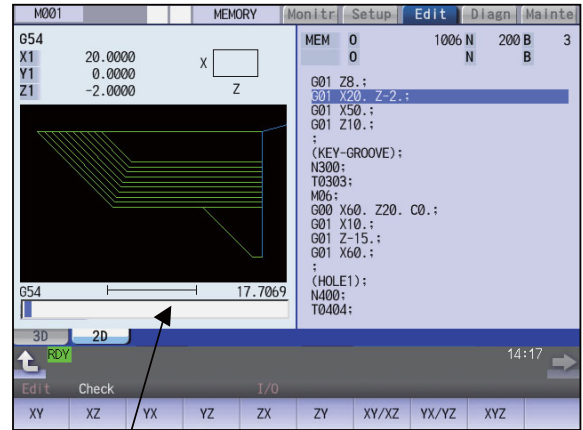

■ Full-screen display ([All display] is ON)

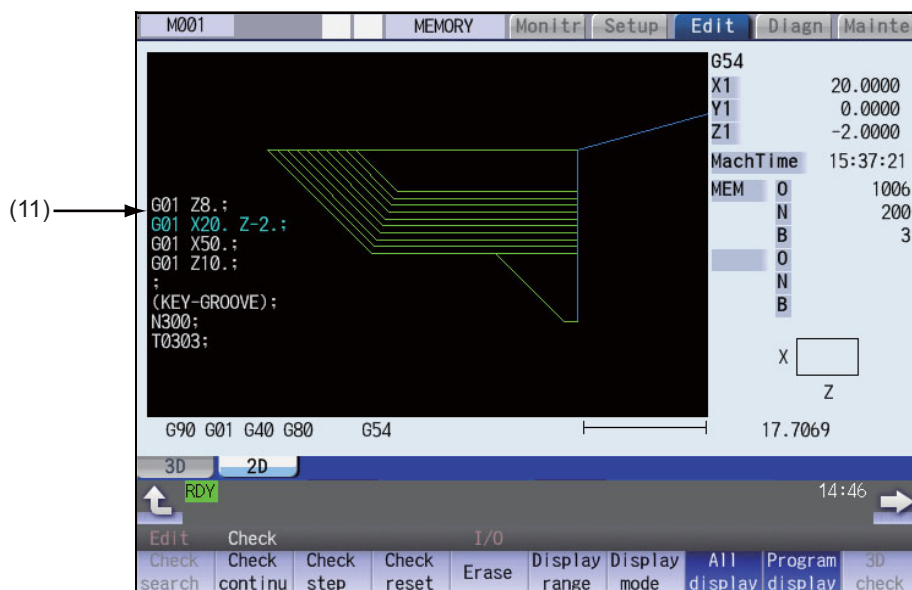

Display items

Display items	Details
(1) Check counter	<p>This displays the axis counter for the check drawing. When the drawn coordinate system is set to all workpiece coordinates with the menu [Drawing System], the counter name and value are switched according to the setting values of the parameters "#1231 set03/bit1" (Switch graphic coordinates) and "#1231 set03/bit5" (Switch graphic check counter display) as follows:</p> <p>#1231 set03/bit1=0 and #1231 set03/bit5=0: Machine position #1231 set03/bit1=0 and #1231 set03/bit5=1: Workpiece coordinate position #1231 set03/bit1=1 and #1231 set03/bit5=0: Tool position (machine coordinate system) #1231 set03/bit1=1 and #1231 set03/bit5=1: Tool position (workpiece coordinate system)</p> <p>When the selected drawn coordinate system is other than all workpiece coordinates, the displayed counter is the workpiece coordinate position or the tool position (workpiece coordinate system) regardless of the parameter "#1231 set03/bit5". The part system common axis name ("#1022 axname2") which conforms to the basic axis name set in the parameters "#1026 base_I", "#1027 base_J", and "#1028 base_K" are displayed for the three axes to display.</p> <p><Note></p> <ul style="list-style-type: none"> •The settings of the parameters "#1026 base_I", "#1027 base_J" and "#1028 base_K" cannot be changed during the execution of 2D program check. The message "Program checking" appears.
(2) 2D drawing area	<p>This is the area where the tool path is drawn. The drawing viewpoint can be moved, and the drawing size can be enlarged and reduced.</p> <p>The display for the path to be drawn will be switched among "only tool center path/only program path/both tool center path and program path" by setting parameters "#1231 set03/bit1" (Switch graphic coordinates) and "#1231 set03/bit2" (Switch graphic check trace).</p> <p>#1231 set03/bit1=0 and #1231 set03/bit2=0: Draws both paths #1231 set03/bit1=0 and #1231 set03/bit2=1: Draws only tool center path (machine position) #1231 set03/bit1=1 and #1231 set03/bit2=0: Draws both paths #1231 set03/bit1=1 and #1231 set03/bit2=1: Draws only program path (tool position)</p> <p><Note></p> <ul style="list-style-type: none"> •If the radius compensation has not been set, only tool center path (machine position) is drawn even when the both paths are set to be drawn. <p>The zero point mark display position is switched between the machine coordinate zero point and workpiece coordinate zero point by the parameter "#1231 set03/bit4" (Switch zero point mark display position).</p>
(3) Machining time display	The time required for machining is calculated and displayed.
(4) G modal display for check	<p><M system></p> <p>The following items are displayed from the left.</p> <ul style="list-style-type: none"> •Absolute/incremental (G90, G91: Group 3) •Operation mode (G00, G01, etc.: Group 1) •Tool compensation (G40, G41, G42: Group 7) •Fixed cycle (G70 etc.: Group 9) <p>The item to be displayed is changed depending on the status of group 24 command modal, when the G code dynamic switching specification for M/L system is valid.</p> <p><L system></p> <p>The following items are displayed from the left.</p> <ul style="list-style-type: none"> •Feed per minute/Feed per revolution (G98, G99: Group 5) •Operation mode (G00, G01, etc.: Group 1) •Nose R compensation (G40, G41, G42: Group 7) •Fixed cycle (G70 etc.: Group 9) <p>The items to be displayed vary depending on the status of group 24 command modal.</p>

4 Checking a Machining Program on Screen

Display items		Details
(5)	Currently executed machining program	This displays the device name, program No., sequence No., and block No. currently being executed. When they exceed the displayable number of characters (12 characters), the excess is abbreviated and displayed (*).
	Main O10...	This displays the sub-program device name, program number, sequence number, and block number for the sub-program currently being executed. When they exceed the displayable number of characters (12 characters), the excess is abbreviated and displayed (*).
(6)	Buffer display	This displays the contents of the machining program currently being executed. The block being executed is highlighted.
(7)	Display mode	This shows the plane to be displayed for the 3-dimensional display. It can be selected with the menu [Display mode].
(8)	Scale	This shows the display range scale. The unit is set to [mm/100pixel] in millimeters and [inch/100pixel] in inches. Use the menu [Zoom in] or [Zoom out] to change the scale value.
(9)	Input section	This displays details of the key input when setting the scale value and the display axis name, and when setting the extended workpiece coordinate system as the coordinate to draw. Select the menu [Display range] and [Display mode] to display the input area. With the [INPUT] key, the input area is hidden for the scale value and display axis name settings. With the menu [Drawing system], the input area is displayed in the disabled state. With the menu [Coord G54.1P], the input area is enabled and the input area is hidden using the [INPUT] key.
(10)	Coordinate system Drawing coordinate settings	This displays the currently selected drawing coordinate settings.
(11)	Program display	At the full screen display, the contents of the machining program that is in the process of drawing are displayed. The block currently being executed is displayed in blue characters.

Menus

Menus	Details
Check search	This performs a check search. Select a program to be checked from the program file list displayed in the pop-up window. For only the machining programs in NC memory, the check search is executed across all part systems in batch when the multi-part system program management is valid (#1285 ext21/bit0 =1, ext21/bit1 =1).
Check continu	This checks the program continuously.
Check step	This checks the program per block.
Check reset	This resets the program check.
Erase	This erases the graphics displayed on the screen. Each time this menu is pressed, the graphic data is erased in the order of rapid traverse and cutting feed. When the graphic is drawn after setting "#1231 set03/bit2" (Switch graphic check trace) to "1", pressing this menu again erases whichever a path of rapid traverse or cutting feed at once.
Display range	This changes the graphic drawing display range. Press this menu to display the input area for setting the scale value. When the display range is changed, the graphic data displayed on the screen is erased.
Display mode	This changes the drawing plane. Press this menu to display the input area for setting three axes of drawing targets. There are three types of graphic drawing mode: 1-plane, 2-plane, and 3-dimension. This changes the drawing plane and erases the graphic data displayed on the screen.
All display	This switches the normal display mode and the full-screen display mode.

Menus	Details
Program display	This displays the machining program being checked on the graphic drawing area. Note that this menu can be used only when the full-screen display mode is selected.
3D check	This changes the program check (3D) display. This menu cannot be selected while the check is performed or interrupted.
Opt Skip	Select whether to execute a block that has a slash "/" in the program to be checked. Selecting "ON" skips a block with a slash "/" to carry out drawing. Selecting "OFF" also draws a block with a slash "/".
Rotate	This sets the viewpoint angle for the 3-dimension display mode. When the viewpoint angle is changed, the graphic data displayed on the screen is erased. However, this menu cannot be used for other than the 3-dimension display mode.
Std range	The display range (scale and display position) is automatically set from the machine movable area. The machine movable area is set with the parameters "#2013 OT-" and "2014 OT+" (software limit). When the display range is changed, the graphic data displayed on the screen is erased.
Drawing System	This sets the name and values of the counter to display in the graphic check, and the coordinate system to be drawn.
M0/M1 neglect	Designate whether to stop program check when M0/M1 is commanded. If [M0/M1 neglect] is set to ON, program check does not stop even when M0/M1 is commanded. If [M0/M1 neglect] is set to OFF, program check stops when M0/M1 is commanded.
Auto Graphic	After the scale is automatically adjusted so that the entire machining program can be displayed in the 90% of the drawing area, the graphic is drawn on the center of the drawing area. It is automatically adjusted in the following cases for 1-plane display mode. <ul style="list-style-type: none"> ♦When the program is selected ♦When display size is switched (normal display <-> full display) ♦When the part system is changed ♦When the display range is changed When auto graphic is valid, the menu is highlighted.
Grid display	Whether to display or not the grid line in the drawing area for the 1-plane display mode can be selected. When the grid view is enabled, the scale value and scale bar size are obtained as the dimension value per grid. Enabling the grid view displays the scale extension line. Disabling the grid view erases the scale extension line. When the grid display is valid, the menu is highlighted.
Next axis	This changes the axis to be displayed on the counter. This switches between "Basic axes IJK" and "C axis". <Note> <ul style="list-style-type: none"> ♦This menu cannot be selected in the following cases: <ul style="list-style-type: none"> - When the control axis address other than C is specified in the parameter "#19405 Rotary ax drawing". - When C axis is specified in the user parameter "#1026 base_I" (Base axis I), "#1027 base_J" (Base axis J), or "#1028 base_K" (Base axis K). - When the "Graphic check/trace rotary axis drawing" specification is invalid.
Re-do scale	After the scale of auto graphic is automatically re-adjusted, the graphic is drawn on the center of the drawing area. This menu is valid when auto graphic is valid. This menu is used when the graphic cannot fit the scale of auto graphic by changing the data which affects scale such as tool compensation, workpiece coordinate system offset or sub-program.

Note

- (1) The menus [Check search], [Check continu], [Check step] and [Check reset] cannot be selected while the check is performed or interrupted.
Menu can be selected after [Check reset] is pressed.
- (2) The menus [Check Search], [Check continue], [Check step], and [Check reset] are grayed out during automatic operation in trace mode, and the 3D solid check is disabled. If the program is not in the process of automatic operation, a check is possible only for 3D solid.
- (3) The menu [M0/M1 neglect] is grayed out during continuous check, and the menu cannot be selected.
- (4) The menu [Re-do scale] is grayed out when the auto graphic is invalid, and the menu cannot be selected.

Drawing color during check

The path of the tool center path (machine position) is drawn during the check. However, if a compensation is applied on the program being checked, the program path (tool position) and tool center path (machine position) are drawn.

While the compound type fixed cycle for turning machining I (G70, G71, G72, or G73) is commanded in L system, the program path (tool position), tool center path (machine position) and the path before tool shape compensation for turning machining are drawn.

The colors of the lines displayed during the check are expressed as follows.

		With compensation	Without compensation
Manual feed		-	-
Rapid traverse	Program path	Solid line (white)	-
	Tool center path	Solid line (blue)	Solid line (blue)
	Path before tool shape compensation for turning machining (Compound type fixed cycle for turning machining I)	Solid line (red)	Solid line (red)
Cutting feed	Program path	Solid line (white)	-
	Tool center path	Solid line (green)	Solid line (green)
	Path before tool shape compensation for turning machining (Compound type fixed cycle for turning machining I)	Solid line (red)	Solid line (red)



4.1.1 Checking Continuously

There are three types of method for checking the program.

- Checking the specified program
- Checking the program currently opened on the edit screen (Edit)
- Checking the program searched on the monitor screen (Monitr)

Operation method (Selecting a program to be checked)

Checking the specified program

- (1) Press the  key to switch the part system.
In addition to the above, the PLC signal and touch-screen operation are provided as the part system switching method.
- (2) Press the main menu [Check] on the edit screen.
Press the menu [2D Check] when the program check (3D) appears.
- (3) Press the menu [Check search].
If you press the menu [Commentnondisp] in the second page, the comment is hidden.
- (4) Select the device.
(Example) Menu [Memory]
- (5) (For the devices other than NC memory)
Use the [↑], [↓], , or  key to align the cursor with a directory to be newly created.





The selected device name and directory (memory: /program) appear in the device name and directory display columns.
For the devices other than NC memory, root directory is selected.

Press the [INPUT] key to move to inside the directory.

<Note>

- If the list contents differ from the actual device or directory, press the menu [List Update].
- Press the menu [Sort change] to change the sort. Each time the menu key is pressed, the sort method shifts in the following order: file names in ascending order -> file names in descending order -> dates and comments in ascending order -> dates and comments in descending order -> file names in ascending order.

- (6) Press the [↑], [↓],  or  key to move the cursor to the program to be searched.
The name of the machining program to be edited can be input in the input area.
When the touchscreen display unit is used, you can also select a program by touch operation.

- (7) Press the [INPUT] key.
When setting data exists in the input area, a search is performed in this data. This procedure is also used when performing an NB search.
(Example)
1001/1/2 O1001 N1 B2
1001.PRG/1/2 O1001.PRG N1 B2
/1/2 (current O number) N1 B2
1001//2 O1001 N0 B2
1001/1 O1001 N1 B0
1001 O1001 N0 B0
/1 (current O number) N1 B0
//2 (current O number) N0



The check search is started.
The operation message "Search complete" appears when the search is completed.
After performing the search, the device and program position appear in the current machining program display column.
The list is then closed.
The system distinguishes between the presence or lack of an extension, and therefore due care should be taken.

Note

- (1) The operation message "Sorting of tool data is in progress" is displayed when tool data is being sorted, and the check search is disabled.

Checking the program currently opened on the edit screen

- (1) Press the  key to switch the part system.
In addition to the above, the PLC signal and touchscreen operation are provided as the part system switching method.
- (2) Press the menu [Program check] on the edit screen.
Press the menu [2D Check] when the program check (3D) appears.

Checking the program searched on the monitor screen

- (1) Press the  key to switch the part system.
In addition to the above, the PLC signal and touchscreen operation are provided as the part system switching method.
- (2) Press the menu [Check] on the monitor screen.
Press the menu [2D Check] when the program check (3D) appears.

Operation method (Executing the program check)

- (1) Press the menu [Check continu].

Behaviors during check operation

- ◆ Press the menu [Check step], the program check is carried out block by block starting from the next block.
- ◆ Press the menu [Check continue], the program check is stopped. Press the menu [Check continu] during block stoppage, the program check is carried out continuously.
- ◆ Press the menu [Check reset], the program check is reset after completion of the currently executing block.



A program check is executed and that path is drawn. A "Checking" message appears and the menu is highlighted. The check counter display is updated. The check G modal is not displayed. The machining time is updated. Program check is carried out for the currently displayed part system. As necessary, switch the part system to be displayed.

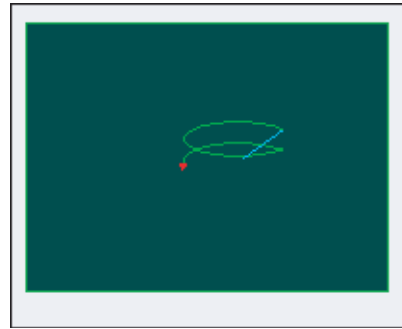

When the check is completed, a message appears and the mode returns to normal. The menu highlight returns to normal.

When the setting of the bit1 or bit2 of parameter #1231 is changed, you can switch the drawing path. Refer to "4.1.14 Switching the Draw Path" for operation procedures.

Note

- (1) The operation message "Sorting of tool data is in progress" is displayed when tool data is being sorted, and the check search is disabled.

4.1.2 Checking One Block at a Time

There are three types of method for checking the program.

- Checking the specified program
- Checking the program currently opened on the edit screen (Edit)
- Checking the program searched on the monitor screen (Monitr)

Perform the same procedure as "4.1.1 Checking Continuously" on selecting a program.

Operation method (Executing the program check)

- (1) Press the menu [Check step].



The program check is executed for one block, and a graphic drawing of the machining program movement path is made.
The check counter display is updated.
The check G modal display is updated.
The machining time is updated.
<State during one block check>

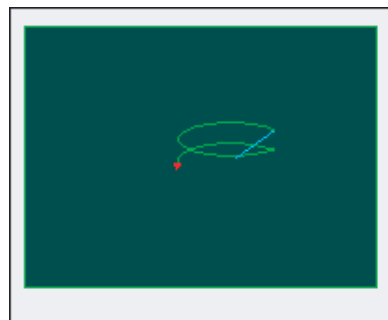

<State when one block check is completed>

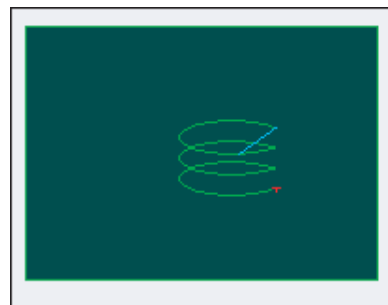

- (2) Press the menu [Check step].



Behaviors during check operation

- Press the menu [Check continue], program check is carried out continuously up to the end of the program.
- Press the menu [Check reset], the program check is reset.

The program check is executed for the single block.
When the check is completed, a message appears and the mode returns to normal.
The menu highlight returns to normal.

When the setting of the bit1 or bit2 of parameter #1231 is changed, you can switch the drawing path.
Refer to "4.1.14 Switching the Draw Path" for operation procedures.

Note

- (1) The operation message "Sorting of tool data is in progress" is displayed when tool data is being sorted, and the check search is disabled.

4.1.3 Setting the Coordinate System to Draw

Press the menu [Drawing system] to select the coordinate system to draw from among the coordinate selection menus below. During the graphic check, it is possible to draw paths of the running programs of the selected coordinate system only. If "All wk. coord" is selected, all paths of the program will be drawn. If other than "All wk. coord" is selected, paths of the program of only selected coordinate will be drawn. The default setting is "All wk. coord".

Note

- (1) The coordinate system to draw that is set here is held even after turning the power ON again.
- (2) When the parameter "#1231 set03/bit4" (Switch zero point mark display position) is set to "1", the zero point mark's position is not of the selected coordinate system to draw, but of the workpiece coordinate system or extended workpiece coordinate system specified by the machining program being checked.
- (3) The coordinate system to draw is common between part systems.
- (4) The drawing coordinate system settings of 2D and 3D graphic check are not linked.
- (5) When the drawing coordinate system is set for other than "All Wk. Coord", if switching the coordinate system has not been commanded in the program to execute the program check, this draws the program performs drawing in the currently set coordinate system, that is not the correct position. Thus, make sure that the coordinate system is specified in the program.

Menus to select the coordinate system to draw

Menus	Description
All wk. Coord	This draws all workpiece coordinate systems. The display for the check counter switches by the setting of the parameter "#1231 set03/bit1" (Switch graphic coordinates) and "#1231 set03/bit5" (Switch graphic check counter display). In the area to show the setting of the coordinate system to draw, "All Work" is displayed. #1231 set03/bit1=0 and #1231 set03/bit5=0 : Machine position #1231 set03/bit1=0 and #1231 set03/bit5=1 : Workpiece coordinate position #1231 set03/bit1=1 and #1231 set03/bit5=0 : Tool position (machine coordinate system) #1231 set03/bit1=1 and #1231 set03/bit5=1 : Tool position (workpiece coordinate system)
G54	This specifies the workpiece coordinate (between G54 and G59) as a coordinate system to draw. In the graphic check counter, the workpiece coordinate position or tool position (workpiece coordinate system) counter is displayed regardless of the setting of the parameter "#1231 set03/bit5" (Switch graphic check counter display). In the area to show the setting of the coordinate system to draw, the selected workpiece coordinate system is displayed.
G55	
G56	
G57	
G58	
G59	
Coord G54.1 P	This specifies the extended workpiece coordinate (G54.1 Pn) as the coordinate system to draw. The extended workpiece coordinate (G54.1 Pn) can be selected for the type of coordinate system to draw by inputting the P No. The graphic check counter is changed to the workpiece coordinate position or tool position (workpiece coordinate system) counter regardless of the setting of the parameter "#1231 set03/bit5" (Switch graphic check counter display). In the area to show the setting of the coordinate system to draw, the selected workpiece coordinate system is displayed.

Select the type of workpiece coordinate system to draw (When selecting all workpiece coordinates, or coordinate system G54-59)

(1) Press the menu [All wk. coord].



In the area to show the setting of the coordinate system to draw, "All Work" is displayed.

In the same manner, by pressing a menu between [G54] and [G59], in the area to show the setting of the coordinate system to draw, the selected workpiece coordinate system is displayed.

Select the type of workpiece coordinate system to draw (When selecting the coordinate system G54.1P)

(1) Press the menu [Coord G54.1P].

(2) Input "20", and press the [INPUT] key.



In the area to show the setting of the coordinate system to draw, "G54.1P20" is displayed.

Note

(1) When the [All wk. coord] or [G54] to [G59] is pressed while the menu [G54.1P] is being selected, the pressed menu is selected as the coordinate system to draw.

Difference of drawing depending on the selected workpiece coordinate system

The drawing of 2D check changes as follows depending on the selection of the sub menu of [Drawing system].

(Example)

<p>[Workpiece coordinate] G54: X 100.000 Y 100.000 Z 0.000 G55: X 200.000 Y 200.000 Z 0.000</p>	<p>[Machining program] N1 G28 XYZ ; N10 G90 G54 G0 X100. Y100. Z100. ; N11 G91 G01 X-100. F500 ; N12 Y-100. ; N13 X100. ; N14 Y100. ; N15 Z-100. ; N16 Y-100. ; N17 Z100. ; N18 G0 Y100. Z-100. ; N19 G01 X-100. F500 ; N20 Z100. ; N30 G28 XYZ ; N40 G90 G55 G0 X200. Y200. Z200. ; N41 G91 G01 X-100. F500 ; N42 Y-100. ; N43 X100. ; N44 Y100. ; N45 Z-100. ; N46 Y-100. ; N47 Z100. ; N48 G0 Y100. Z-100. ; N49 G01 X-100. F500 ; N40 Z100. ; N50 G28 XYZ ; M30 ; % ;</p>
---	--

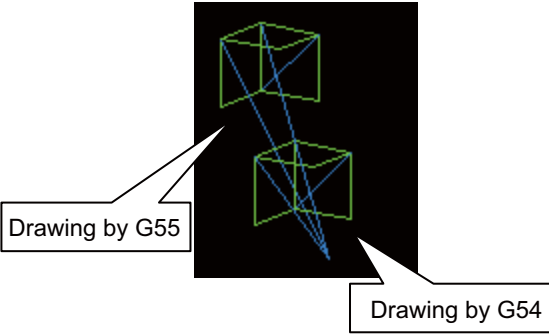
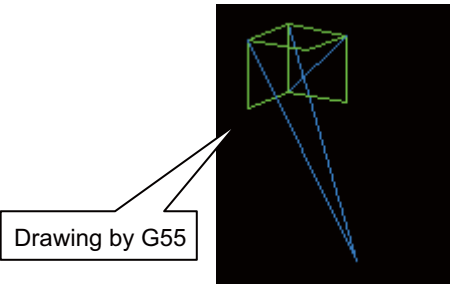
Drawing coordinate system selection	Drawing at 2D check	
All wk. coord		Workpiece coordinates G54 and G55 both are drawn.
Workpiece coordinate system G55		Workpiece coordinate G55 is drawn. G54 is not drawn.

4.1.4 Drawing during a Program Check

During the program check, the tool center path (machine position) is drawn. However, if a radius compensation is applied on the program being checked, the program path (tool position) and tool center path (machine position) are drawn.

The colors of the lines displayed during the program check are expressed as follows.

		With radius compensation	Without radius compensation
Manual feed		-	-
Rapid traverse	Programmed path	White	-
	Tool center move path	Blue	Blue
Cutting feed	Programmed path	White	-
	Tool center move path	Green	Green

4.1.5 Changing the Display Range

The graphic drawing's scale can be enlarged or reduced, and the position moved or centered.

Operation method (Enlarging and reducing the drawing)

(1) Press the menu [Display range].

(2) Press the menu [Zoom In] or [Zoom out].

To enlarge the figure:

Press the menu [Zoom in] or [-] key.

To reduce the figure:

Press the menu [Zoom out] or [+] key.

A solid-line frame appears with respect to the original scale when enlarging, and a dotted-line frame appears when reducing.



The size of the yellow frame can be changed by using key operations.

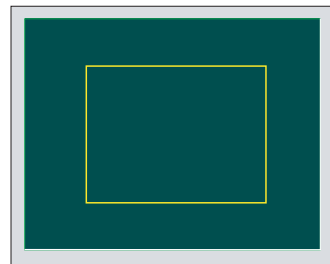

(3) Press the [INPUT] key.



The display scale changes.

By changing the display scale, the graphic data displayed on the screen is erased.

When auto graphic is valid, the graphic data is automatically drawn again on the changed display scale.

Operation method (Changing the drawing display position)

(1) Press the menu [Display range].

(2) Press the menus [↑], [↓], [←], [→] or cursor movement keys [↑], [↓], [←], [→].



The cursor (□) indicating the center of the display and the frame line move up, down, left and right according to the key operations.

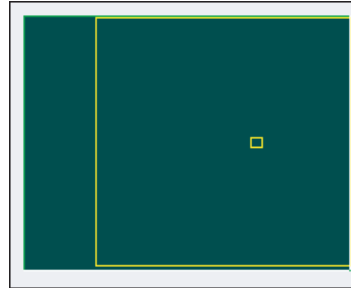

(3) Press the [INPUT] key.



The display position changes so that the cursor position (□) is the center of the area. When display position is changed, the graphic data displayed on the screen is erased. The scale value is not changed.

Note

(1) When changing the display range while the 2-plane display mode such as [XY/XZ], the display range (scale and display position) for the upper and lower areas changes in the same manner. The operation method is the same as the 1-plane display mode.

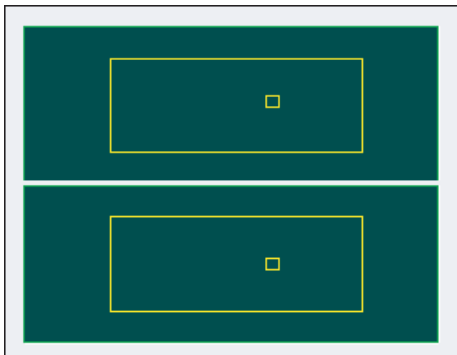

The white-framed display range in the upper and lower areas simultaneously move to the left/right when the [←], [→] keys are pressed.

The white-framed display range of either upper or lower areas moves up and down when the [↑], [↓] keys are pressed.

Which frame to be moved up/down can be changed with the page key.

(2) The set display angle is maintained even after rebooting the machine.

(3) The graphics are not automatically drawn even when auto graphic is valid.

Operation method (Centering)

(1) Press the menu [Display range].

(2) Press the menu [Centering].



The display position is changed so that the current machine position appears in the center of the drawing area. The graphic displayed up to that point is cleared and the drawing starts again from the current position (the center of the drawing area).

When auto graphic is valid, the graphic data is automatically drawn again in the changed display range.

Note

- (1) In the 2-plane display mode such as [XY/XZ], centering is applied for the upper and lower areas. The operation method is the same as the 1-plane display mode.
- (2) When the menu [Centering] is pressed after the display scale has changed, only the centering is applied without changing the scale value.

Setting range of the scale value

#1003 Input setup unit	#1041 I_inch	
	0 (mm)	1 (inch)
B	0.100 to 9999.999	0.0100 to 9999.9999
C	0.0100 to 9999.9999	0.00100 to 9999.99999
D	0.00100 to 9999.99999	0.000100 to 9999.999999
E	0.000100 to 9999.999999	0.0000100 to 9999.9999999

- (3) The set scale value is maintained even after the power is turned OFF and ON.
- (4) In the 2-plane display mode such as [XY/XZ], the change of the scale input range is applied for the upper and lower area. The operation method is the same as the 1-plane display mode.

4.1.6 Changing the Display Mode

There are three types of graphic drawing mode: 1-plane, 2-plane, and 3-dimension. Press the menu [Display mode] key, and by selecting one of the sub menus, the axis configuration for each plane changes, and the menu display returns to normal. Set the axis name in the input area and select the [INPUT] key to change three axes of the drawing targets.

Note

- (1) When the display angle is changed, the graphics displayed up to that point are erased.
- (2) These set display mode is maintained even after rebooting the machine.
- (3) The display mode can be set independently for the trace function and program check function. These settings are not linked with one another.
- (4) The menu axis names XYZ are compatible with the basic axes IJK. X = base axis I, Y = base axis J, and Z = base axis K.
- (5) When you select the menu of the plane or cube which does not exist on actual axis configuration, the display mode is not switched.

(Example) In case that you select the [XY] or [XYZ] menu on the 2-axis (X and Z axes) configured machine

Display mode menu

Menus	Description
XY	This changes to the 1-plane display mode configured of X-Y. The X axis is displayed in the horizontal axis, and the Y axis is displayed in the vertical axis.
XZ	This changes to the 1-plane display mode configured of X-Z. The X axis is displayed in the horizontal axis, and the Z axis is displayed in the vertical axis.
YX	This changes to the 1-plane display mode configured of Y-X. The Y axis is displayed in the horizontal axis, and the X axis is displayed in the vertical axis.
YZ	This changes to the 1-plane display mode configured of Y-Z. The Y axis is displayed in the horizontal axis, and the Z axis is displayed in the vertical axis.
ZX	This changes to the 1-plane display mode configured of Z-X. The Z axis is displayed in the horizontal axis, and the X axis is displayed in the vertical axis.
ZY	This changes to the 1-plane display mode configured of Z-Y. The Z axis is displayed in the horizontal axis, and the Y axis is displayed in the vertical axis.
XY/XZ	This changes to 2-plane display mode configured of X-Y and X-Z. The X axis is displayed as the horizontal axis, and the Y axis and Z axis are displayed as the vertical axis.
YX/YZ	This changes to 2-plane display mode configured of Y-X and Y-Z. The Y axis is displayed in the horizontal axis, and the X and Z axes are displayed in the vertical axis.
XYZ	This changes to the 3D display mode. A cube is displayed on the lower right of the screen.

Changing the display axis name

- (1) Set the axis name and press the [INPUT] key.
XYC [INPUT]



XYZ appears the graphic display mode name. There are 3 drawing axes: X, Y, and C.
The X axis, Y axis and C axis are the three axes for drawing.

There are three types of display mode: 1- plane, 2- plane, and 3D. An image displays which display mode is currently selected. The selected axis name displays for the image axis name.

Display example

<1-plane> (XY)	<2-plane> (XY/XZ)	<3-dimension> (XYZ)

4.1.7 Changing the Display Angle

This is used to set the graphic drawing display angle when in 3-dimension display mode.

Press the menu key or cursor keys to rotate the cubic displayed at the screen upper right and press the [INPUT] to set.

Note

- (1) When the display angle is changed, the graphics displayed up to that point are erased.
- (2) The set display angle is maintained even after rebooting the machine.
- (3) The display angle can be set independently at the trace function and program check function. These settings are not linked with one another.

Operation method

- (1) Press the menu [Rotate].

- (2) Use the menus [↑], [↓], [←], [→] to adjust the display angle.
The cursor movement keys ([↑], [↓], [←], [→]) can also be used to rotate.



Rotate the cubic display in the lower right of the screen using the operation keys.

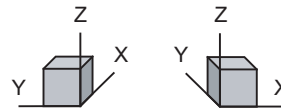

- (3) Press the [INPUT] key.



The display angle changes.
By changing the display angle, the graphic data displayed on the screen is erased.

Note

- (1) The set display angle is maintained even after rebooting the machine.

4.1.8 Switching the Axis Movement Direction (+, -)

The path is drawn according to the axis movement direction designated by the parameter "#1495 grf_ax_direction". The movement direction can be set for each axis.

When "#1495 grf_ax_direction" is set to "0", the axis movement directions are as follows.

<2D mode>

<3D mode>

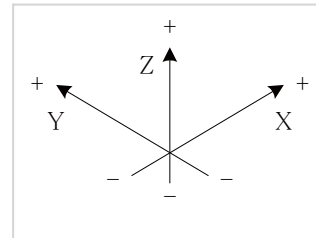
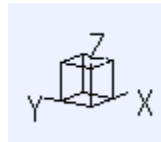
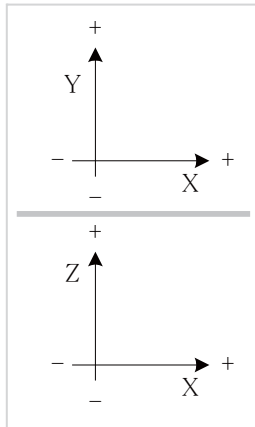
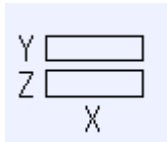

When the axis movement direction is opposite direction, the axis direction movement of 2D or 3D mode are as follow.

(Example) When the Yaxis movement direction is set in the opposite direction

<2D mode>

<3D mode>

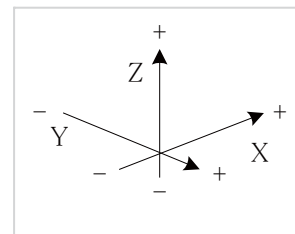
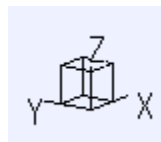
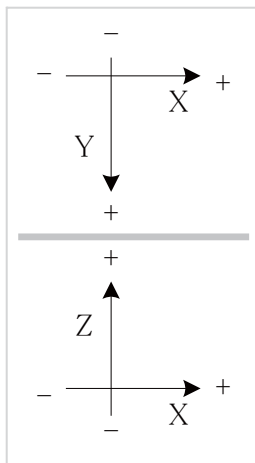
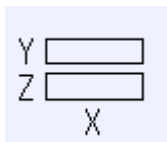

4.1.9 Displaying the Machining Program on Checking

When pressing the menu [Program display], the contents of the machining program on checking is displayed on the drawing area.

When pressing the menu [Program display] again, the displayed program is erased.

Note that this menu can be used only when the full-screen display mode is selected.

Note

- (1) The selected display mode is maintained even after rebooting the machine.
- (2) The program display mode is applied to the trace function and program check (2D) function commonly.
- (3) The menu [Program display] cannot be selected while the normal display mode is selected. Program display mode is valid only when the full-screen display mode is selected.
- (4) The program display mode is applied commonly to all part systems.

4.1.10 Switching to Full-screen Display Mode

Press the menu [All display] to display the program check window on the whole screen (full-screen display mode).

Press this menu again to return the normal display.

Switching the display mode

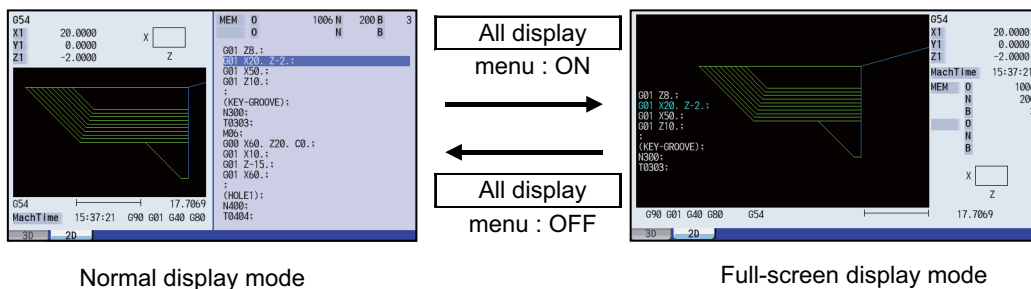

Normal display mode

Full-screen display mode

Note

- (1) The selected display mode is maintained even after rebooting the machine.
- (2) The full-screen display mode is applied to the trace function and program check (2D/3D solid) function commonly.
- (3) The full-screen display mode is applied commonly to all part systems.
- (4) When auto graphic is valid, the graphic is drawn after the drawing's scale is automatically adjusted to the scale to draw the entire machining program (the area of about 90% of the drawing area).

4.1.11 Setting Auto Graphic

If [Auto graphic] is valid, a graphic is automatically drawn when a file is selected to check a graphic, the display size is switched (normal display <-> whole display), the part system is changed or the display range is changed.

When a file is selected, the part system is changed, or the display size is switched, a graphic is drawn in the center of the drawing area after the scale is automatically adjusted so that the entire machining program can be drawn in the 90% of the drawing area.

A drawing path is switched according to the setting of parameter "#1231 set03/bit1, bit2".



Refer to "4.1.14 Switching the Draw Path" for operation procedures.

(1) Press the menu [Auto Graphic].

(2) Press the menu [Check search].



The check search list is displayed.

(3) Use the [↑], [↓], , or  key to point the cursor with the target machining program.
(Or enter the target file name in the input area.)

(4) Press the [INPUT] key.



The check search is started.
The message "Search completed" appears when the search is completed.

When the check search is completed, the graphic previously displayed is erased and the auto-adjustment of the scale starts.

During the auto-adjustment, a message "Executing auto scale" is highlighted.

When the auto-adjustment of the scale is completed, "Checking" message is displayed and the graphic drawing is performed automatically.

When the graphic drawing is completed, the message "Program check completed" is displayed and the graphic drawing mode is canceled. The highlight of each menu returns to normal and the menus become selectable.

Precautions

- (1) Auto graphic is executed only for the 1-plane display mode. The menu [Auto Graphic] cannot be selected for the other modes. Auto graphic mode always remains as it is in the 1-plane display mode.
- (2) Once the auto graphic mode is set, it is retained after the power is turned ON again.
- (3) The auto graphic cannot be set for the trace function.
- (4) The auto graphic mode is common between part systems.
- (5) Even the M00 or M01 command is issued, the program does not stop.
- (6) If a program which contains M99 command is selected, auto adjustment of the scale will be executed repeatedly and the adjustment will not be completed with the "Executing auto scale" message blinking.
Do not select a program which contains M99.
Execute check reset when it happens.
- (7) When a large capacity program is selected, it may take time to perform the auto graphic.
- (8) If the display size is switched (between normal and full screen) or the display range is changed during program check, the auto graphic drawing is not carried out even if the auto graphic is valid. Auto graphic drawing is performed only when the figure is enlarged or reduced.
- (9) If a check search is performed on a file which went through an auto-adjustment of the scale, only graphic drawing is performed as long as there is no changes in "a path and a file name (including a device)", "the date of updating", or "display mode (XY/YZ/XZ.. etc)". Maximum 12 files can be memorized, to which the automatic scale adjustment has been executed.
Therefore, if the 13th file is check-searched and the automatic scale adjustment is executed, the information of the first file is lost. When the first file is check-searched again, the automatic scale adjustment starts after check search has been completed.
- (10) The automatic scale adjustment is interrupted if one of the following operations is taken:
 - ♦Press the menu [Check reset].
 - ♦Press the menu [Auto Graphic].
 - ♦The screen is changed to other than [2D check].
 - ♦A program error occurs.
- (11) When the data related to the machining program (tool compensation, workpiece coordinate system offset, sub-program, etc.) drawn with the auto graphic once is changed, the shape of auto graphic may not fit on the screen. In this case, press the menu [Re-do scale] to re-adjust the scale.
The following situations are examples which the auto graphic shape does not fit on the screen.
 - ♦When the parameter "#1051 MemTol" (Tool compensation memory common for part systems) was set to "1", the tool compensation amount was changed and the part system was switched.
 - ♦After the tool compensation amount was changed, the operation search was performed on other machining program.
 - ♦The values were changed on the workpiece coordinate offset screen or common variable screen.
 - ♦The sub-program was edited.

4.1.12 Availability of Check Mode with Other Functions

It is important to be aware that certain NC parameters, program commands, and machine operation panel switches cannot be used while performing a program check.

Function name	Remarks
Decimal point programming	Both decimal point input type I and II are valid.
Mirror image	A mirror image is applied and a check drawing is made at the setting status prior to starting the check.
Mirror image by external input	The signal is reflected, and a check drawing is carried out (Foreground). The signal is ignored, and a check drawing is carried out (Background).
Z axis command cancel	Signals are ignored and a check drawing is made.
Interlock	Signals are ignored and a check drawing is made.
External deceleration	Signals are ignored and a check drawing is made.
Override	Signals are ignored and a check drawing is made.
Auto operation pause (feed hold)	Signals are ignored and a check drawing is made.
Auto operation start-up (cycle start)	If you press the cycle start button during checking, the operation alarm "M01 program check mode" is displayed (foreground) while the button is held down. The operation can be started automatically even during check drawing (background).
Auto-restart	The check is completed at M02/M30 and is not restarted.
Workpiece coordinate offset	Offset is enabled (the target is drawn at the position determined with the designated offset amount).
Manual mode/handle	If the mode is switched to the manual mode during checking, the operation alarm "M01 program check mode" is displayed (foreground). During checking, you can switch to the manual mode, HANDLE, to move the machine. However, the drawing position of the check is not affected by the mode change (background).
F1-digit feed	The speed command does not influence the check drawing.
User macro I, II	Basic variable calculations, decisions and branch functions are all enabled. However, the following functions are ignored. <ul style="list-style-type: none"> •Macro interface input/output •Single block stop •Miscellaneous function complete signal waiting control •Feed hold •Feedrate override •G09 enabled/disabled control •Reading of position information for other than the previous block end point coordinates
M, S, T and 2nd miscellaneous function commands	M, S, T and 2nd miscellaneous function command signals commanded by the program during the check are not output. Neither do they display on the operation screen etc. The auxiliary function command by manual operation on the position display screen is output even during checking.
G command modal	G modal displays on the modal display screen while the check drawing is being made.
Optional block skip	The setting status when starting the check drawing are used (foreground). Use the menu to switch ON and OFF. The optional block skip state is held until the power is turned ON again, which is common to part systems. However, when the power is turned ON again, the mode is always turned OFF (background).
Spindle position control (spindle/C axis control)	When the program command method is selected, the spindle/C axis moves in the C axis mode.

Note

(1) Reference position return and start position return

The reference position return command and start position return command are valid, but actual machine motion (trace display) is partially different from the drawing by program check.

As shown in the figure below, when returning to the reference position via the intermediate point with the G28 or G30 command, positioning to the intermediate point is done by a straight line and positioning from there to the reference position is done by each axis independently.

With the G29 command, positioning to the intermediate point is done by each axis independently.

Under program checking, however, positioning is always done by a straight line even when returning via the intermediate point. This may cause a little difference from the trace display.

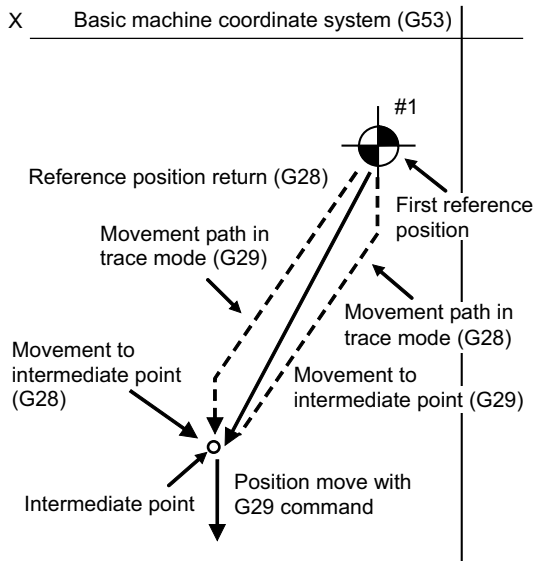

4.1.13 Handling of Variable Commands, Programmable Parameter Input, and Programmable Compensation Data Input

If a program check is performed for a machining program for which the variable command data etc. is rewritten, all data types are treated as shown in the following table after completion. The setting commands, which are executed to various data during program check, are reflected on only drawing of background check. The actual machining operation is not affected.

Handling of variables, parameter and compensation amount (foreground)

Data type	Returning to pre-checked data after check completion	Details
Parameter	×	The programmable parameter input commands are set as actual data. (The data before the check is not saved.)
Local variable	○ / ×	It is possible to return to the status prior to starting the program check based on the value of the parameter "#1231 set03/bit0" (Graphic check compatibility parameter). 0: Returns to original status after check completion 1: Does not return to original status after check completion
Common variable	○ / ×	
Workpiece coordinate system offset	○ / ×	
Tool compensation amount	○ / ×	

Handling of variables, parameter and compensation amount (background)

Data type	Returning to pre-checked data after check completion	Details
Parameter	○	The parameter input commands which have been executed at the program check are not set as actual data. (The data before the check is not saved.)
Local variable	○	The parameter "#1231 set03/bit0" (Graphic check compatibility parameter) is disabled.
Common variable	○	
Workpiece coordinate system offset	○	
Tool compensation amount	○	

4.1.14 Switching the Draw Path

The path to be drawn can be switched by designating a parameter.

■Parameter "#1231 set03/bit2" (Switch graphic check trace)

The number of the paths to be drawn can be switched. It is immediately activated after the setting.

Parameter value	Description
0	Both the tool center path (machine position) and program path (tool position) are drawn. However, the radius compensation is not reflected for the program path.
1	Only path designated with "#1231 set03/bit1" (Switch graphic coordinates) is drawn.

■Parameter "#1231 set03/bit1" (Switch graphic coordinates)

The drawn path where the parameter "switch graphic check trace" is set to "1" can be switched. It is immediately activated after the setting.

Parameter value	Description
0	Only the tool center path (machine position) is drawn.
1	Only program path (tool position) is drawn. The path does not reflect the radius compensation.

The counter display is switched depending on the combination of the setting values of the parameters "#1231 set03/bit1" and "#1231 set03/bit5". When the drawing coordinate system by the menu [Drawing system] is set for other than "All wk. coord", the counter of the workpiece coordinate position or the tool position (workpiece coordinate system) is displayed regardless of a parameter "#1231 set03/bit5".

#1231		set03/bit5	
		0	1
set03/bit1	0	Machine position	Workpiece coordinate position (*1)
	1	Tool position (machine coordinate system)	Tool position (workpiece coordinate system) (*1)

(*1) The name of the counter display is changed according to the currently executed workpiece coordinate system.

4.1.15 Drawing a Path Corresponding to the Rotary Axis (L System)

When the rotary axis (C axis) is designated with the parameter "#19405 Rotary ax drawing" in program check (2D), the path is drawn depending on the rotary axis. The rotary axis can be set for each part system.

Note

- (1) The "Graphic check/trace rotary axis drawing" option is also required to use this function.
- (2) When the control axis address other than C axis is designated with the user parameter "#19405 Rotary ax drawing", the path corresponding to the rotary axis is not drawn.
- (3) The workpiece coordinate system must be set so that the center of the rotary axis becomes the coordinate system zero point.

Image of the actual tool and workpiece

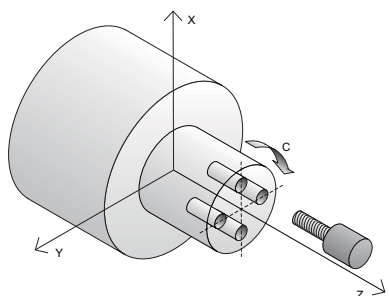

Example of machining program

```

%
O0512
T1
G97S1000M74
M19
G28H0
G0C0
G0X50.Z5.
G98
G83Z-20.R-5.Q5000F300
G0C90.
G83Z-20.R-5.Q5000F300
G0C180.
G83Z-20.R-5.Q5000F300
G0C270.
G83Z-20.R-5.Q5000F300
G80
G0Z20.
G28U0.M75
M18
M30
%
```

Drawing image for 2D mode		Drawing image for 3D mode	
When the rotary axis drawing is invalid	When the rotary axis drawing is valid	When the rotary axis drawing is invalid	When the rotary axis drawing is valid

4.1.16 Setting the Drawing Speed of Program Check

Check speed of graphic check can be accelerated. When accelerating, set the parameter "#8997 Hi-speed grph chck" to "1" to "3" (Level 1 to Level 3). However, the shape of workpiece drawing becomes the one taking inner route than the path commanded by the program.

When you want to confirm the shape with high-accuracy, disable the high-speed graphic check.

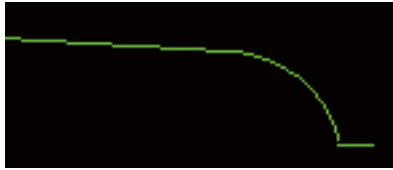
High-speed graphic check invalid	High-speed graphic check valid
<p data-bbox="213 501 735 555">The shape can be confirmed with high-accuracy. The check speed is low.</p> 	<p data-bbox="810 501 1278 555">The check can be performed at high-speed. Minute shape collapses.</p> 

Note

- (1) The setting of high-speed graphic check is not reflected while [Check continu] or [Check step] is operated in the background.
- (2) High-speed graphic check is valid only for check method I.

4.1.17 Notes for Graphic Check (2D)

Check function

- (1) The check function is valid for only NC internal operation results. Thus, the path is not drawn for the command which requires machine movement.
- (2) For the handling of various types of data being set in the program, refer to "4.1.13 Handling of Variable Commands, Programmable Parameter Input, and Programmable Compensation Data Input".
- (3) If the menu [M0/M1 neglect] is OFF, the program check is stopped by the M00/M01 command. The drawing is also stopped during M01 command execution regardless of the ON/OFF switch status of the optional stop switch signal (XC41).
- (4) When the menu [M0/M1 neglect] is ON, the program check does not stop even if M00/M01 is commanded.
- (5) "Program check completed" appears with M02/M30 command.
- (6) Graphic check is not available for serial and MDI program.
- (7) Operation search is not available for the program whose file name is consist of 33 characters or more.
- (8) When the check is executed, the drawing starts from the machine coordinate zero point. However, the machine coordinate zero point is (0, 0, 0) even when the value is set to the parameter "#2037 G53ofs" (zero point return).
- (9) The drawing coordinate system settings of 2D and 3D graphic check are not linked.
- (10) Drawing is continued even after changing to another screen during the tracing or checking modes.
- (11) Graphic check (2D) cannot be performed during the trace mode.
- (12) If the screen is switched to 2D check screen during trace, the confirmation message for trace OFF appears. Only when trace is turned OFF, the transition to 2D check screen is performed. If trace is not turned OFF, the message "Tracing" appears and 2D check screen displays blank.
- (13) When trace window is displayed during check, check will be terminated. (This applies for all the part systems under checking.)
- (14) The drawing is erased if the performance such as enlarge, reduce, move, change display mode, or rotate is set during check drawing. The program does not stop.
- (15) When part systems are switched during checking, drawing will be erased. When the displayed part system is undone, check operation will be continued from the previous state (program position before part systems were switched).
- (16) Status during checking (in "Check continu" or "Check step") is held per part system.
- (17) Check reset is available only for the displayed part system.
- (18) When the drawing coordinate system is set for other than "All Wk. Coord", the drawing is not executed because the drawing is performed in currently set coordinate system when there is no command to switch the coordinate system in the program to execute the program check. Make sure the coordinate system is specified in the program.
- (19) When the parameter "#1231 set03(bit4)" (Switch zero point mark display position) is set to "1", and when the workpiece coordinate system or extended workpiece coordinate system is selected as the drawing coordinate system, the displayed zero point mark's position is not of the selected coordinate system to draw, but of the workpiece coordinate system or extended workpiece coordinate system specified by the machining program being checked.
- (20) When the rotary axis (C axis) is specified by the parameter "#19405 Rotary ax drawing" and the C axis is used as the spindle position control (spindle C axis control) axis, a path corresponding to the rotary axis will be drawn as long as the rotary axis moves regardless of the state.
- (21) The machine position of the rotary axis may not be temporarily clamped at 360°.
- (22) When the rotary axis drawing function is ON, an arc in cylindrical interpolation will be drawn as a straight line.
- (23) If Nose R compensation is carried out during cylindrical interpolation with the rotary axis drawing function ON, the tool path may be different from the programmed path.
- (24) The check search cannot be executed when the sub part system that cannot be operated is displayed. If the search is carried out, the message "Search error" appears. (Only Lathe system)

Precautions for drawing on foreground

- (1) If you press the cycle start button when an arbitrary part system is being checked, the operation alarm "M01 program check mode" is generated and the cycle start is disabled while the button is held down.
Press the auto start button after the check is completed or after the check is stopped with the menu [Check reset].
- (2) If you carry out the operation search or check operation (continuous or step check) during cycle start or automatic stop of an arbitrary part system, an operation message "Executing automatic operation" is displayed, and no search or check drawing is carried out.
- (3) "Program check completed" appears with M02/M30 command. For the tape mode, the rewind process is not carried out.
- (4) The check ends with the reset (NC reset or the menu [Check reset]).
When a program error occurs, cancel the error with the operation indicated above.
If NC reset is selected when the check screen is being displayed, check drawing ends but the menu to switch to the 2D check or 3D check is kept invalid. To enable this switching, press the menu [Check reset].
- (5) During automatic operation, the contents of automatic operation program are displayed by the "Currently executed machining program" (ONB display) and "Buffer display" on the check screen. During checking, the contents of the checking program are displayed by the "Currently executed machining program" (ONB display) and "Buffer display" on the monitor screen.
- (6) If you carry out the operation search or check operation (continuous or step check) when the program is restarted, the "Program restarting" operation message is displayed, and no search or check drawing is carried out.
- (7) If the manual operation mode is selected during checking, the "M01 program check mode" is displayed and the axis cannot be moved. If you need to move the axis, temporarily stop the current check by executing a reset and then move the axis. When you switch from the manual operation mode to the memory mode, the alarm is released. You can continue the current check even if an alarm is output.
- (8) When the PLC Interrupt signal is turned ON during checking, the "M01 Program check mode" is selected. To start the PLC interrupt, terminate the current check by executing a reset. When you turn the PLC interrupt signal OFF, the alarm is released. You can continue the current checking even if the PLC Interrupt signal is ON.
- (9) The check mode ends with the reset or other operations, such as setting the tracing ON.
- (10) All part systems are reset if NC reset is executed during checking. If a part system other than displayed part systems is being checked, switching the part system executes the program check from the top of the program.
- (11) If the origin set operation is performed during checking, the result of the origin set is reflected to the value of the work-piece coordinate counter; however, the value returns to that before the check when the check is completed or with the reset.

Precautions for drawing on background

- (1) The program that you have selected during Check Search is not the program that is executed during automatic operation. Search the program for automatic operation by using the operation search function of the monitor screen.
- (2) The parameters and compensation amount do not reflect on check drawing even if you set them during checking. To reflect them on the drawings, reset the check once. Then, press the menu [Check continu] or [Check step] and execute the check again.
- (3) "Program check completed" appears with M02/M30 command.
- (4) The check is not terminated via execution of a reset.
If a program error occurs, release the error by selecting the menu [Check reset].
- (5) When part systems are switched during checking, drawing will be erased. Note that even if the part system is returned to the original one, its drawing during cutting is not displayed.
- (6) During check search, if the length of the full path name exceeds 48 characters, you cannot move to another directory.
- (7) If the menu [Optional Skip] is ON (highlighted), the blocks that have the "/" character are skipped and the T-code list is obtained.
- (8) The file name continues to be displayed as an O-number display even if you erase or rename the file after it is checked and searched. If you check a file in this status, the "Push [Check reset] menu" message is displayed.
- (9) During checking, if you read the integrated time by using variable number #3001 or #3002, the checking start time is obtained. You cannot write the integrated time.
- (10) When [Check continu] is executed, even if variable number #3006 is used for checking, you cannot stop the program and you cannot display the message.
- (11) The check mode ends with the operations, such as setting the tracing ON.

Full screen display of program check function (2D)

- (1) This function is an additional specification. When the menu [M0/M1 neglect] is set to OFF and trace 2D check is enabled, the graphic drawing area is enlarged or reduced horizontally or vertically if the normal display is changed to the full-screen display. At this time, the scale value remains unchanged.

Precautions for automatic graphic

- (1) Auto graphic is executed only for the 1-plane display mode. The menu [Auto Graphic] cannot be selected for the other modes. The menu is grayed out. Auto graphic mode always remains as it is in the 1-plane display mode.
- (2) Once the auto graphic mode is set, it is retained after the power is turned ON again.
- (3) The auto graphic cannot be set for the trace function.
- (4) The auto graphic mode is common between part systems.
- (5) If the display size is switched (between normal and full screen) or the display range is changed during program check, the auto graphic drawing is not carried out even if the auto graphic is valid.
- (6) If a program error occurs during the auto adjustment of the scale, a message "Push [Check reset] menu" appears, and no auto adjustment of the scale or graphic drawing is carried out.
- (7) Even the M00 or M01 command is issued, the program does not stop.
- (8) If a program which contains M99 command is selected, auto adjustment of the scale will be executed repeatedly and the adjustment will not be completed with the "Executing auto scale" message blinking.
Do not select a program which contains M99.
Execute check reset when it happens.
- (9) When a large capacity program is selected, it may take time to perform the auto graphic.
- (10) If the display position of a figure is changed by changing the display range, auto graphic drawing is not carried out.

Precautions for grid display

- (1) Grids are displayed only in the 1-plane display mode. The menu [Grid display] cannot be selected in any mode other than the 1-plane display mode. The menu is grayed out. During the grid display mode, the state in the 1-plane display mode is maintained.
- (2) If the display mode is switched (to 2-plane or 3-dimensional) while the grid display is valid, the scale extension line is erased. However, the scale extension line is displayed when the mode is returned to the 1-plane display mode.
- (3) The set grid display is maintained even after the screen is switched. However, it is not maintained after the power is turned OFF and ON.
- (4) The grid display mode cannot be set for the trace function.
- (5) The grid display mode is common between part systems.

Graphic check rotary axis drawing

When the parameter "#19405 Rotary ax drawing" is set to "0" (disabled) in the program check function (2D), and a rotary axis is designated with any of the base axis parameter I, J or K (#1026 to #1028) due to the machine configuration, the movement of the C axis is drawn with a linear path. Setting the base axis parameter for graphics I, J or K (#8631 to #8633) enables the C axis not to move with linear path. Set the following value in the base axis parameter for graphics corresponding to the base axis parameter in which the C axis is designated:

The name of the axis which is not used for the base axis parameter among the names of the linear axes that configure the plane (except for the name of the C axis) Set the names of the linear axes, that configure the plane, in the other base axis parameters for graphics.

Select the plane or cube on which the graphic is to be drawn by the menu [Display mode], and the linear path drawing due to the C axis movement is not performed at this time.

The setting of the base axis parameter for graphics is valid when the following conditions are satisfied.

If the conditions are not satisfied, the setting of the base axis parameter for graphics is ignored and the graphic is drawn by the setting of the base axis parameter.

[Enabling conditions for the base axis parameter for graphics]

- The specification of "Graphic check rotary axis drawing" is invalid.
- The C axis is designated in the base axis parameter I, J or K (#1026 to #1028).
- The axis name which is not used for the C axis is set in the base axis parameter for graphics corresponding to the base axis parameter in which the C axis is designated. (When the C axis is designated as an axis name, the linear path drawing due to the C axis movement is performed.)

Note

- (1) When the setting of the base axis parameter for graphics has been changed (including when no value is set), the new setting is enabled after you re-select the plane or cube by the menu [Display mode] on the 2D check screen. Also, when the power is turned ON, the setting is enabled after re-selecting the menu [Display mode].

Setting example of the base axis parameter for graphics

Axis configuration (#1013)	Base axes I, J and K (#1026 to #1028)	Base axes for graphics I, J and K (#8631 to #8633)	OK or NG for the setting
[X, Z, C]	[X, C, Z]	[X, Y, Z], [Z, Y, X]	OK
		e.g. [X, Z, Y], [Z, X, Y]	NG
[X, Y, C]	[X, Y, C]	[X, Y, Z], [Y, X, Z]	OK
		e.g. [X, Z, Y], [Y, Z, X]	NG
[Y, Z, C]	[C, Y, Z]	[X, Y, Z], [X, Z, Y]	OK
		e.g. [Y, X, Z], [Z, X, Y]	NG

If the setting value is in NG state, you may not select the plane or cube by the menu [Display mode] on the 2D check screen.

Finish shape view before compensation of tool shape for turning machining (Compound type fixed cycle for turning machining)

The tool shape compensation for turning machining of compound type fixed cycle for turning machining draws a different machining path from the finish shape commanded with the machining program. Because it compensates the finish shape itself.

Finish shape view before compensation draws the path of the finish shape before compensation when any of G71 to G73 is commanded in the graphic check (2D). The finish shape view before compensation is displayed, then the finish shapes before and after compensation can be compared by displaying the rough cutting cycle with G71 to G73 in the normal manner. That enables to check the uncut section left by tool shape compensation for turning machining and the change of finish shape.

To display the finish shape view before compensation, set the parameter "#8137 T. tool shape comp" to "1" and "#8138 Pre-compens. Shape" to "0".

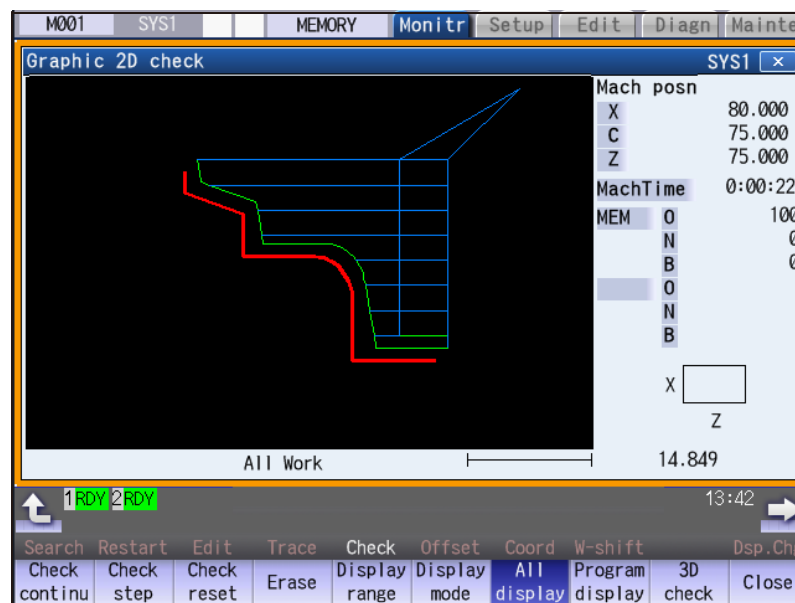

Note

- (1) While the finish shape before compensation is being drawn, the machining time is not counted.
- (2) The finish shape view before compensation is displayed only in the graphic check (2D). This is not displayed in other display functions (such as graphic trace and graphic check (3D)).
- (3) For the finish shape before compensation, the compensation function other than the tool shape compensation for turning machining such as nose R compensation is enabled.
- (4) In the finish shape view before compensation, the program can also be drawn by one block with [Check step] menu.
- (5) In the finish shape view before compensation, the following movements are not drawn.
 - from the cycle command point to the finish shape start block
 - from the finish shape end block to the cycle command point

4.2 Graphic Check (3D) (M System)



Graphic check (3D) is a function that allows you to check the machining program movement path only by drawing without automatic operations. Therefore, the graphics can be drawn at a high speed and high accuracy, and the machining program can be checked.

Press the menu [Check] on the monitor or edit screen to switch to the graphic check screen.

Program check (3D) can draw a solid image in the basic machine coordinate system or the workpiece coordinate system. The coordinate system used to draw can be switched on "Work set" screen. In the workpiece coordinate system, a solid image is drawn by using the workpiece coordinate system designated by the program.

This function requires workpiece and tool shape settings.

Using the menu [All display], normal display and whole display modes can be switched.

Note

(1) When changing the screen to the edit screen, display depends on the previous checking type (2D/3D). If 2D graphic data appears, press the menu [3D check]. Note that when transferring to this screen during graphic trace, 3D solid program check is displayed.

[Terms]

The following descriptions are the meanings of the terms used in this chapter.

Foreground: Active state operated by the user such as automatic operation on the NC

Background: Inactive state operated in the back of foreground

[Check method]

There are two types of 3D graphic check as below, which can be switched by [Type change] menu.

Note

(1) Make sure to select the check method before the check is started. During the check, [Type change] menu is grayed out, and the check method cannot be changed.

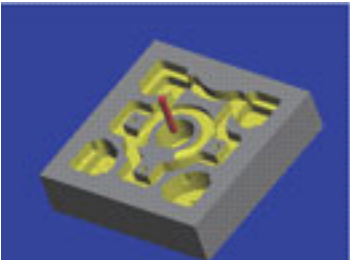
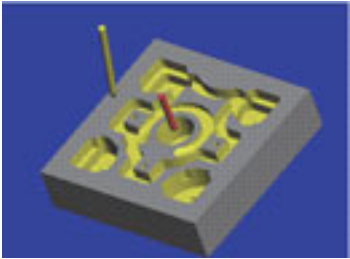
Check method	Outline of drawing	Details
<p>Check method I</p>	<p>This method simplifies the machining result of machining program and simulates at a high speed. A machining program in single part system (displayed part system) is drawn. In 3D drawing area, one workpiece and one tool are displayed. The travel command for the rotary axis is drawn.</p> 	<p>This method is operated on the background on M800W, M800S and M80W. This method is operated on the foreground on M80 and E80.</p>
<p>Check method II</p>	<p>This method simulates the machining result of machining program at a higher accuracy than check method I. Machining programs in multiple part systems can be drawn simultaneously. In 3D drawing area, one workpiece and tools for part systems are displayed.</p> 	<p>This method is available only when the operation mode in the part system to be simulated is in the memory mode. This method is operated on the foreground and in the machine lock status during the program check. Also, during the program check, the PLC signal (Graphic check (Check method II) in progress X759) is turned ON. The program check cannot be started during automatic operation in arbitrary part system.</p> <p>The program check is in operation from the program execution by pressing the menu [Check continue] or [Check step] on the check screen to the following status.</p> <ul style="list-style-type: none"> ◆Program ends. ◆The menu [Check reset] is pressed. ◆The reset signal or emergency stop signal outputs. ◆The screen is moved from the check screen to another one.

The following functions are supported with check method I and check method II.

○: Available ×: Not available Δ: Depending on the model

Item	Check method I	Check method II
Operation in a single part system	○	○
Multi-part system simultaneous operation	×	○
Rotary axis movement command	×	○
Tool center point control	×	○
Inclined surface machining	×	○
Coordinate system used for 3D drawing	×	○
Operate on the background	Δ (*1)	× (*2)

(*1) Operation on the background is available on M800W, M80W and M800S, but operation on the foreground is available on M80 and E80.

(*2) With check method II, operation only on the foreground is available regardless of the models. During the check, the high-speed simple program check is started. For the limitations of operation on the foreground, refer to "4.2.16 Notes for Graphic Check (3D)".

The following shows the differences of drawing contents between check method I and check method II.

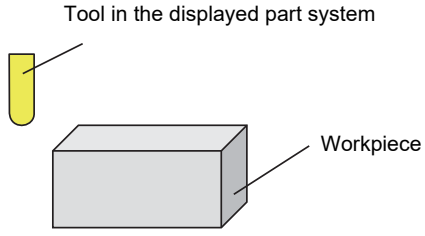
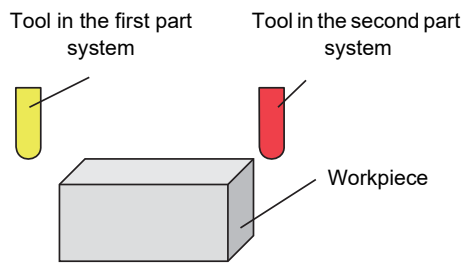
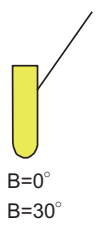
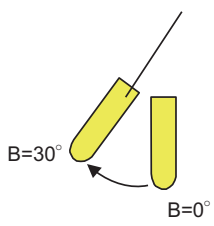
Item	Check method I	Check method II
Multi-part system simultaneous operation	<p>Only machining result of the machining program in the displayed part system is drawn (One tool is displayed).</p> 	<p>Machining results of the machining program in multi-part system are drawn simultaneously (Tools are displayed for the number of the part systems).</p> 
Rotary axis movement command	<p>Tool does not rotate even if the command for the rotary axis is issued.</p> <div style="border: 1px solid black; padding: 5px; width: fit-content; margin-bottom: 10px;">Machining program G1 B30°</div> <p>Tool does not rotate.</p> 	<p>Tool rotates when the command for the rotary axis is issued.</p> <div style="border: 1px solid black; padding: 5px; width: fit-content; margin-bottom: 10px;">Machining program G1 B30°</div> <p>Tool rotates.</p>  <p>For details on the drawing of rotary axis travel command, refer to "4.2.13 Drawing Travel Command of the Rotary Axis (Check Method II)".</p>

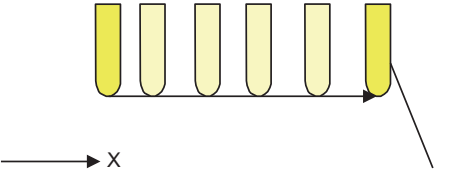
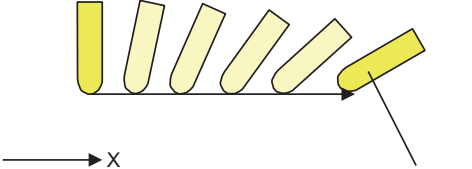
Item	Check method I	Check method II
<p>Tool center point control</p>	<p>Tool center point control command (G43.4, G43.5) is ignored and the machining result is drawn just like normal command even when the tool center point is commanded.</p> <div data-bbox="368 461 630 573" style="border: 1px solid black; padding: 5px; margin: 10px 0;"> <p>Machining program G43.4 H1 G1 X50 B60</p> </div> <div data-bbox="368 611 842 824"> <p>Tool at the start point Tool at the end point</p>  <p>The tool moves only on the orthogonal axes and does not rotate.</p> </div>	<p>Tool center point control command (G43.4, G43.5) is not ignored and the machining result is drawn so that the position commanded by the machining program is located at the center of tool tip on the coordinate system which rotates with the workpiece.</p> <div data-bbox="895 461 1157 573" style="border: 1px solid black; padding: 5px; margin: 10px 0;"> <p>Machining program G43.4 H1 G1 X50 B60</p> </div> <div data-bbox="895 611 1369 824"> <p>Tool at the start point Tool at the end point</p>  <p>During tool center point control, the tool rotates with the tool tip as the rotation center.</p> </div>
<p>Coordinate system used for 3D drawing</p>	<p>You can select either machine coordinate system or workpiece coordinate system. For details, refer to "4.2.10 Setting the Workpiece Shape".</p>	<p>Machine coordinate system only.</p>

■ Normal display ([All display] is OFF)

<Drawing area>

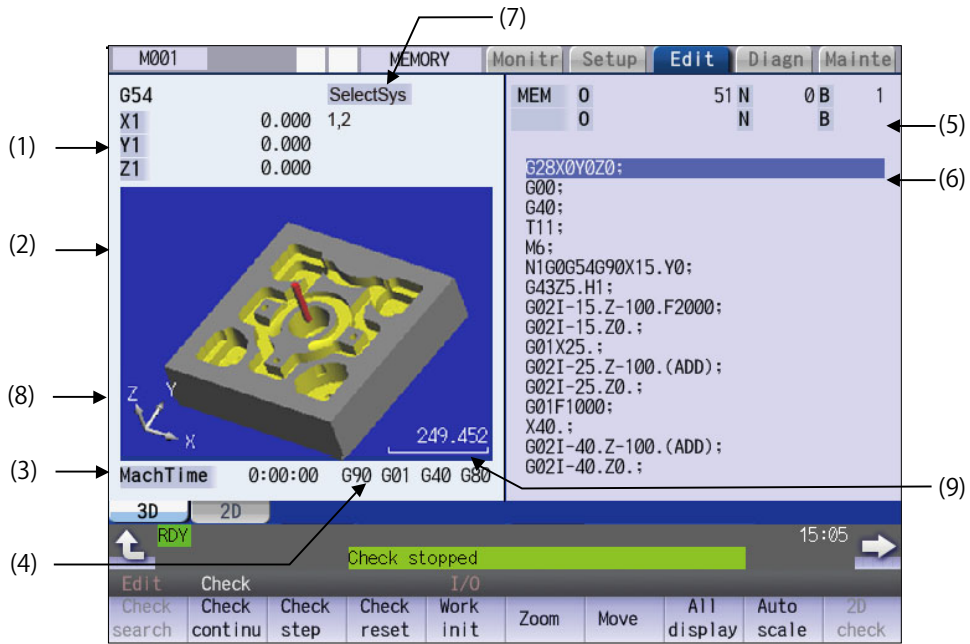

■ Full-screen display ([All display] is ON)

<Drawing area>

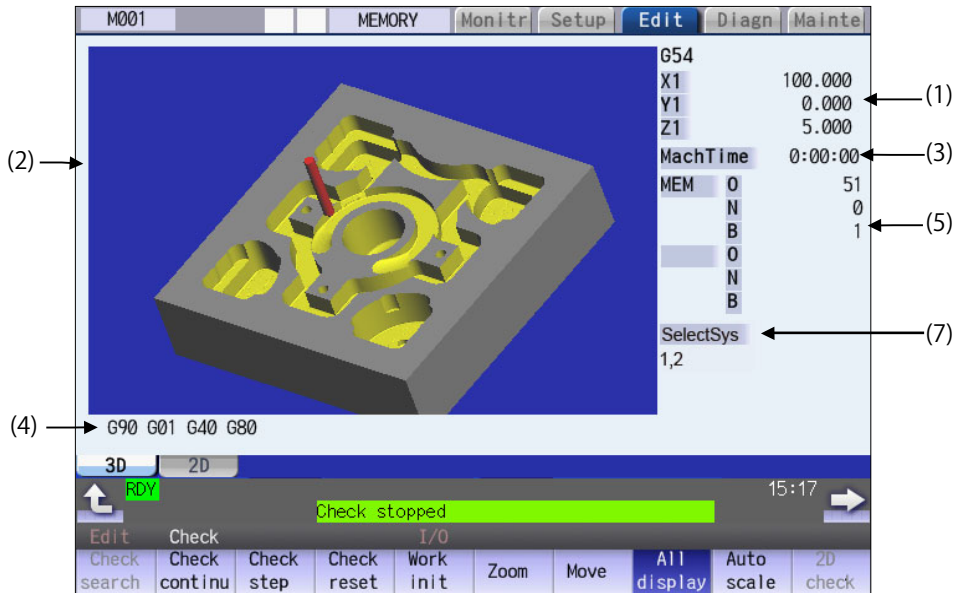

Display items

Display items		Details	
(1)	Check counter	<p>This displays the axis counter for the check drawing. As for the counter, the machine position or workpiece coordinate position is displayed according to setting the drawing coordinate system on "Work set" screen.</p> <p>As for the axes name, system common axis name ("#1022 axname2") based on the basic axis name set by the parameters "#1026 base_I", "#1027 base_J", and "#1028 base_K" are displayed.</p> <p>[Check method I]</p> <p>This displays the workpiece coordinate counter for the current part system (the part system being checked).</p> <p>[Check method II]</p> <p>This displays the machine coordinate counter for the current part system (it is not necessarily the part system being checked).</p>	
(2)	3D drawing area	<p>This area is used to display a solid graphic drawing of the workpiece shape and tool movement during the cutting process in the machining program. The drawing view-point can be moved, and the drawing size can be enlarged and reduced.</p> <p>The coordinate system used to draw switches the basic machine coordinate system or a workpiece coordinate system according to setting the drawing coordinate system on "Work set" screen.</p>	
(3)	Machining time display	The time required for machining is calculated and displayed.	
(4)	G modal display for check	<p>The following items are displayed from the left.</p> <ul style="list-style-type: none"> ◆Absolute/incremental (G90, G91: Group 3) ◆Operation mode (G00, G01, etc.: Group 1) ◆Tool compensation (G40, G41, G42: Group 7) ◆Fixed cycle (G70 etc.: Group 9) <p>The items to be displayed vary depending on the status of group 24 command modal.</p>	
(5)	Currently executed machining program	Main O10...	<p>This displays the device name, program No., sequence No., and block No. currently being executed.</p> <p>When they exceed the displayable number of characters (12 characters), the excess is abbreviated and displayed (*).</p>
		Sub O1234...	<p>This displays the sub-program device name, program number, sequence number, and block number for the sub-program currently being executed.</p> <p>When they exceed the displayable number of characters (12 characters), the excess is abbreviated and displayed (*).</p>
(6)	Buffer display	<p>This displays the contents of the machining program currently being executed.</p> <p>The block being executed is highlighted.</p>	
(7)	Part system to be checked (Check method II only)	<p>This displays the part system to be checked (the part system for which the parameters "#8982 CheckSmltns\$1Invlid" to "#8989 CheckSmltns\$8Invlid" are set) (up to eight part systems).</p> <p>This menu is displayed with check method II only.</p>	
(8)	Coordinate system display	This displays the coordinate system direction. This displays the axis direction of the base axis I/J/K with arrow.	
(9)	Scale display	This shows the display range scale. The unit is set to "mm/80pixel" in millimeters and "inch/80pixel" in inches.	

Menus	
Menus	Details
Check search	This performs a check search. Select a program to be checked from the program file list displayed in the pop-up window. For only the machining programs in NC memory, the check search is executed across all part systems in batch when the multi-part system program management is valid (#1285 ext21/bit0 =1, ext21/bit1 =1).
Check continu	This checks the program continuously.
Check step	This checks the program per block.
Check reset	This resets the program check.
Work init	This initializes the workpiece shape. Displays the pre-machining workpiece shape set at the "Work set" window (workpiece shape setting).
Zoom	This enlarges/reduces the displayed workpiece shape.
Move	This moves the displayed workpiece shape.
All display	This switches the normal display mode and the full-screen display mode.
Auto scale	The scale is automatically set so that the unmachined workpiece shape set at the "Work set" window (workpiece shape setting) to be approximately 90% of the graphic area.
2D check	This changes the program check (2D) display. This menu cannot be selected while the check is performed or interrupted.
Colli check	This enables or disables the interference check. When the interference check is enabled, if the tool and workpiece contact each other when performing rapid traverse (G0) movement, the contact location is drawn in a color highlighting the interference.
Rotate	This rotates the displayed workpiece shape.
Scale display	This displays the scale of coordinate system direction and display range in the graphic drawing area.
M0/M1 neglect	[Check method I] If [M0/M1 neglect] is ON, the program check does not stop even when M00/M01 is commanded. If [M0/M1 neglect] is OFF, the program check stops when M00/M01 is commanded. [Check method II] The menu [M0/M1 neglect] is grayed out and non-selectable. The program check does not stop in the block where M00/M01 is commanded. (*1)
Type change	This switches between check method I and check method II. <Note> ♦When check method switch is invalid (parameter "#1231 set03/bit7" is set to "1"), this menu is not displayed.
Work setting	This sets the workpiece shape used at the solid display.
Tool setting	This sets the tool shape used at the solid display.

(*1) M code independent output (DM00/DM01) follows the parameter setting indicated below.

- ♦#1284 ext20/bit3 (M code output during multi-system simultaneous simulation (Check type II))
- ♦#1405 M_mode(SMLK) (M code output (during high-speed simple program check))
- ♦#1451 M[M031-000](SMLK) to #1466 M[M511-480](SMLK) (Special operation registration M code (High-speed simple program check))

Note

- (1) When automatic operation is running during the graphic trace mode, the menu [Check search], [Check continu], [Check step], [Check reset] cannot be selected and the 3D solid program check cannot be performed. If the program is not in the process of automatic operation, a check is possible only for 3D solid.
- (2) The menus [2D check], [Check search], [Work setting] and [Tool setting] cannot be selected while the check is performed or interrupted.
- (3) The menu [M0/M1 neglect] is grayed out during continuous check, and the menu cannot be selected.
- (4) The coordinate system direction and the scale display are held after the screen is switched, but they are not held after the power is turned OFF and ON again.

4.2.1 Switching Check Method

Press the menu [Type change] to switch between check method I and check method II. Every time you press the menu, the type is switched between check method I and check method II.

The menu [Type change] is displayed when the check method switch is valid (parameter "#1231 set03/bit7" is set to "0").

You can confirm whether it is in check method I or II by the indication of "SelectSys" on the screen.

Check method I: "SelectSys" is not indicated.



Check method II: "SelectSys" is indicated.

4.2.2 Checking Continuously

There are three types of method for checking the program.

- Checking the specified program
- Checking the program currently opened on the edit screen (Edit)
- Checking the program searched on the monitor screen (Monitr)

Operation method (Selecting a program to be checked)
Checking the specified program



- (1) Press the main menu [Check] on the edit screen.
Press the menu [3D Check] when the program check (2D) appears.
- (2) Press the menu [Check search].
If you press the menu [Commentnondisp] in the second page, the comment is hidden.
- (3) Select the device.
(Example) Menu [Memory]
- (4) (For the devices other than NC memory)
Use the [↑], [↓], , or  key to align the cursor with a directory to be newly created.



The selected device name and directory (memory: /program) appear in the device name and directory display columns.
For the devices other than NC memory, root directory is selected.

Press the [INPUT] key to move to inside the directory.

<Note>

- If the list contents differ from the actual device or directory, press the menu [List Update].
 - Press the menu [Sort change] to change the sort. Each time the menu key is pressed, the sort method shifts in the following order: file names in ascending order -> file names in descending order -> dates and comments in ascending order -> dates and comments in descending order -> file names in ascending order.
- (5) Press the [↑], [↓], , or  key to move the cursor to the program to be searched.
The name of the machining program to be edited can be input in the input area.
When the touchscreen display unit is used, you can also select a program by touch operation.

- (6) Press the [INPUT] key.  The check search is started.
- When setting data exists in the input area, a search is performed in this data. This procedure is also used when performing an NB search.
- When the search is completed, the operation message "Search completed" is displayed.
- The searched device and program position appear in the display area for the machining program currently being executed.
- The list display is closed.
- The system distinguishes between presence and absence of an extension, and therefore due care should be taken.
- (Example)
- ```
1001/1/2 O1001 N1 B2
1001.PRG/1/2 O1001.PRG N1 B2
/1/2 (current O number) N1 B2
1001//2 O1001 N0 B2
1001/1 O1001 N1 B0
1001 O1001 N0 B0
/1 (current O number) N1 B0
//2 (current O number) N0
```

#### Checking the program currently opened on the edit screen

- (1) Press the menu [Program check] on the edit screen.
- Press the menu [3D Check] when the program check (2D) appears.

#### Note

- (1) Regardless of the check method or the setting of the parameters "#8982 CheckSmltns\$1Invlid" to "#8989 CheckSmltns\$8Invlid", the program opened on the edit screen is drawn as a machining program in single part system (displayed part system). Only the displayed part system is displayed in "SelectSys" on the screen.

#### Checking the program searched on the monitor screen

- (1) Press the menu [Check] on the edit screen.
- Press the menu [3D Check] when the program check (2D) appears.

#### Note

- (1) With check method II, among the part systems to be checked (parameters "#8982 CheckSmltns\$1Invlid" to "#8989 CheckSmltns\$8Invlid"), the part system being searched on the monitor screen is drawn.

#### Operation method (Executing the program check)

- (1) Press the menu [Check continu].  The program check is executed for one block, and work-piece shape in the cutting process is drawn.
- Behaviors during check operation
- Press the menu [Check step], the program check is carried out block by block starting from the next block.
  - Press the menu [Check continue], the program check is stopped. Press the menu [Check continu] during block stoppage, the program check is carried out continuously.
  - Press the menu [Check reset], the program check is reset after completion of the currently executing block.
- A "Checking" message appears and the menu [Check continu] is highlighted.
- The check counter display is updated.
- The check G modal is not displayed.
- The machining time is updated.
- When the check is completed, a message appears and the mode returns to normal.
- The menu highlight returns to normal.

#### Note

- (1) The operation message "Sorting of tool data is in progress" is displayed when tool data is being sorted, and the check is disabled.

### 4.2.3 Checking One Block at a Time

There are three types of method for checking the program.

- Checking the specified program
- Checking the program currently opened on the edit screen (Edit)
- Checking the program searched on the monitor screen (Monitr)

Perform the same procedure as "4.2.2 Checking Continuously" on selecting a program.

#### Operation method (Executing the program check)

- |                                                                                                                                                                                                                                                                                                                       |   |                                                                                                                                                                                                                                  |
|-----------------------------------------------------------------------------------------------------------------------------------------------------------------------------------------------------------------------------------------------------------------------------------------------------------------------|---|----------------------------------------------------------------------------------------------------------------------------------------------------------------------------------------------------------------------------------|
| <p>(1) Press the menu [Check step].</p>                                                                                                                                                                                                                                                                               | ➔ | <p>The program check is executed for one block, and work-piece shape in the cutting process is drawn.<br/>The check counter display is updated.<br/>The check G modal display is updated.<br/>The machining time is updated.</p> |
| <p>(2) Press the menu [Check step] again.</p> <p>Behaviors during check operation</p> <ul style="list-style-type: none"> <li>•Press the menu [Check continue], program check is carried out continuously up to the end of the program.</li> <li>•Press the menu [Check reset], the program check is reset.</li> </ul> | ➔ | <p>The program check is executed for the single block.<br/>When the check is completed, a message appears and the mode returns to normal.<br/>The menu highlight returns to normal.</p>                                          |

#### Note

- (1) The operation message "Sorting of tool data is in progress" is displayed when tool data is being sorted, and the check search is disabled.

#### 4.2.4 Checking Multiple Part Systems Simultaneously

With check method II, machining programs in multiple part systems can be drawn simultaneously. If you press the menu [Check continu] or [Check step], the movement path of the machining program in the part system being searched is drawn among the target part systems. Select the target part system with the parameters "#8982 CheckSmltns\$1Invlid" and "#8983 CheckSmltns\$2Invlid" (The part system which the parameter is set to "1" is out of the target).

##### Operation method (Selecting a program to be checked)

- (1) Press the main menu [Check] on the edit screen.  
Press the menu [3D Check] when the program check (2D) appears.
- (2) Press the \$↔\$ key to switch to the part system to be checked.  
In addition to the above, the PLC signal and touch-screen operation are provided as the part system switching method.
- (3) Press the menu [Check search].  
For details on how to search the machining program, refer to "4.2.2 Checking Continuously".
- (4) Repeat (2) and (3) to check the machining program of the part system to be checked.

##### Note

- (1) When the multi-part system program management is valid (#1285 ext21/bit0 =1, ext21/bit1 =1), since the check search is executed across all part systems in batch only for the machining programs in NC memory, the step (4) is not necessary.

##### Operation method (Executing the program check)

- (1) Press the menu [Check continu] or [Check step].  
For details on how to execute the check, refer to "4.2.2 Checking Continuously" and "4.2.3 Checking One Block at a Time".
- 
- The program check is executed, and workpiece shape in the cutting process is drawn.

##### Note

- (1) If you press the menu [Check step], the check is executed (is drawn) on the program of displayed part system by one block. The process of the non-displayed part system moves ahead by the time of one block check for the displayed part system. Thus, the drawing of the non-displayed part system may be interrupted in the middle of a block, or it may proceed for multiple blocks.  
The program check is not executed on the part system for which the parameter (any of #8982 to #8989) is set to "1" (check-invalid part system).  
When the displayed part system is set as a check-invalid part system, the check is executed on the part system whose No. is the smallest among the check-valid part systems by one block.
- (2) If any part system to be checked is not set, the operation message "No check system" is displayed.

### 4.2.5 Canceling the Program Check

**Operation method**

- (1) Press the menu [Check reset].



The check mode is released, and the menu highlight returns to normal.  
The operation message "Reset complete" appears.

Even when the screen transits from the check screen during the program check, the program check is canceled.

With check method II and check method I (M80), the program check is canceled in the middle if the reset signal or the emergency stop signal outputs.

### 4.2.6 Enlarging and Reducing the Workpiece Shape

**Operation method**

- (1) Press the menu [Zoom].
- (2) Press the menu [Zoom in].  
To enlarge the figure:  
Press the menu [Zoom in] or [-] key.  
To reduce the figure:  
Press the menu [Zoom out] or [+] key.

### 4.2.7 Moving the Workpiece Shape

**Operation method**

- (1) Press the menu [Move].
- (2) Use the menu [Up], [Down], [Left], or [Right] to adjust the display position.  
The cursor movement keys ( [↑], [↓], [←], [→] ) can also be used for moving.

### 4.2.8 Rotating the Workpiece Shape

#### Operation method

- (1) Press the menu [Rotate].
- (2) Use the menu [Up], [Down], [Left], or [Right] to adjust the display angle.  
The cursor movement keys ( [↑], [↓], [←], [→] ) can also be used for moving.

#### Note

- (1) The set display angle is maintained even after rebooting the machine.
- (2) When all of storage data concerning the drawing such as display angle become zero by NC data reset, the scale setting is automatically performed (same state as when the menu [Auto scale] is pressed).

### 4.2.9 Performing an Interference Check

If the tool and workpiece contact when performing rapid traverse (G0) movement, the contact location is drawn in a color highlighting the interference.

#### Operation method

- (1) Press the menu [Colli check].
- (2) Press the menu [Check step] or [Check continu].  The program check is executed for one block, and workpiece shape in the cutting process is drawn. A "Checking" message is displayed and the menu [Check step] or [Check continu] is highlighted. The workpiece and tool contact, this is drawn in a color highlighting the interference.

4.2.10 Setting the Workpiece Shape

Press the menu [Work setting] to display a pop-up window similar to the following, and set the workpiece shape used in the solid display.

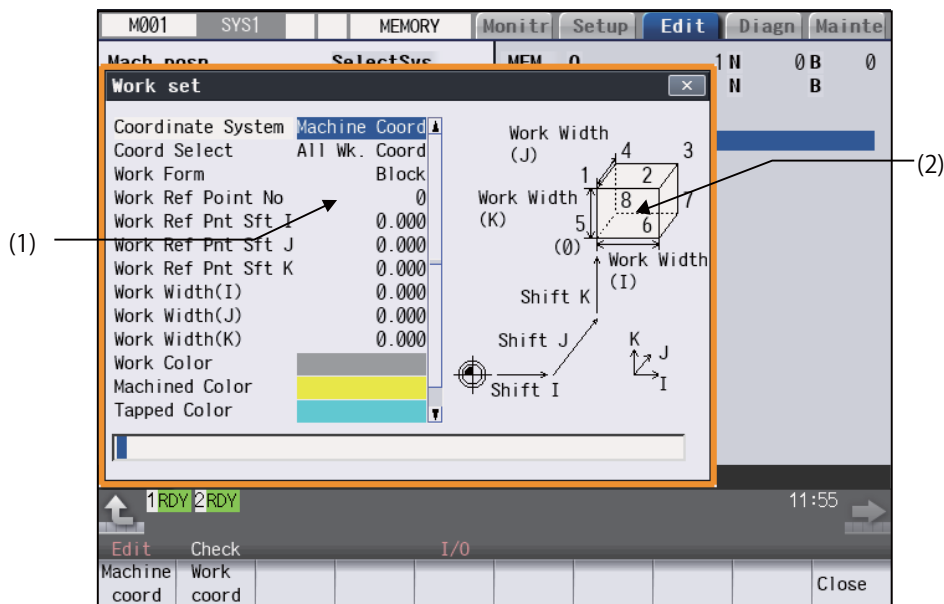

**Display items**

| Display items                       | Description                                                                                                                                 |
|-------------------------------------|---------------------------------------------------------------------------------------------------------------------------------------------|
| (1) Workpiece shape setting area    | This sets all workpiece shape items.                                                                                                        |
| (2) Workpiece setting guide drawing | This displays a material shape guide drawing. The displayed guide drawing is changed according to the coordinates set on "Work set" screen. |

**Menus (the cursor is at "Coordinate System" (drawing coordinate system))**

| Menus         | Description                                                                                                                                                                                                        |
|---------------|--------------------------------------------------------------------------------------------------------------------------------------------------------------------------------------------------------------------|
| Machine coord | This specifies the coordinate system used to 3D drawing. The name and value of the check counter displayed on 3D check screen are switched to the machine position and the workpiece coordinates counter position. |
| Work coord    | The default setting is the "Machine coord" (machine position). When "Machine coord" is selected, "All Wk. Coord" (all workpiece coordinates) is set at "Coord Select" (workpiece coordinate system selection).     |
| Close         | This closes the pop-up window and quits this function.                                                                                                                                                             |

**Menus (the cursor is at "Coord Select" (workpiece coordinate system selection))**

| Menus          | Description                                                                                                                                                                                                                                                                                                                           |
|----------------|---------------------------------------------------------------------------------------------------------------------------------------------------------------------------------------------------------------------------------------------------------------------------------------------------------------------------------------|
| All wk. Coord  | This draws all workpiece coordinate systems. When the menu is selected, "All Wk. Coord" (all workpiece coordinates) is displayed at the cursor position. When the drawing coordinate system is "Machine coord" (machine coordinate), "All Wk. Coord" is selected. The default setting is "All Wk. Coord"                              |
| Coord G54-G59  | This specifies the workpiece coordinate (G54 to G59) to the drawn coordinate system. The drawn coordinate system is selected from sub-menu (G54 to G59). If the drawing coordinate system is "Machine coord", this is displayed in gray and cannot be selected.                                                                       |
| Coord G54.1 P_ | This specifies the external workpiece coordinate (G54.1 Pn) to the drawn coordinate system type. The extended workpiece coordinate (G54.1 Pn) can be selected for the type of coordinate system to draw by inputting the P No. If the drawing coordinate system is "Machine coord", this is displayed in gray and cannot be selected. |



| Menus | Description                                            |
|-------|--------------------------------------------------------|
| Close | This closes the pop-up window and quits this function. |

**Menu (the cursor is at "Work Form" (material shape))**

| Menus         | Description                                                                                           |
|---------------|-------------------------------------------------------------------------------------------------------|
| Default shape | This sets the material shape.<br>The drawings are made as a block when the default shape is selected. |
| Block         |                                                                                                       |
| Close         | This closes the pop-up window and quits this function.                                                |

**Menu (the cursor is at "Work Ref Point" (material basic point), or "Work Width" (material width))**

| Menus | Description                                            |
|-------|--------------------------------------------------------|
| Close | This closes the pop-up window and quits this function. |

**Menu (the cursor is at the "Work Color", "Machined Color", "Tapped Color", or "Interference Color" )**

| Menus         | Description                                                                                                                                                                                                                                                                                                                                                                                                                                                                                                                                                                                                                                                                                                                                                                                                              |
|---------------|--------------------------------------------------------------------------------------------------------------------------------------------------------------------------------------------------------------------------------------------------------------------------------------------------------------------------------------------------------------------------------------------------------------------------------------------------------------------------------------------------------------------------------------------------------------------------------------------------------------------------------------------------------------------------------------------------------------------------------------------------------------------------------------------------------------------------|
| Default color | This sets the material color (Work Color), machining surface color (Machined Color), tap surface color (Tapped Color), interference surface color (Interference Color).<br>The drawings are made using the following colors when the default colors are selected.<br>Material color: Gray<br>Machining surface color: Yellow<br>Tap machining surface color: Light blue<br>Interference surface color: Red<br><Note><br>♦The "Tapped Color", that is the same as when the tapping tool is selected, is used on the "Work set" screen. Therefore, switching of the tap surface color and normal surface color depends on not G command but the selected tool. However, even with the tapping tool being selected, if it is moved in the arc or helical direction, the "Work Set" screen does not have the "Tapped Color". |
| Gray          |                                                                                                                                                                                                                                                                                                                                                                                                                                                                                                                                                                                                                                                                                                                                                                                                                          |
| Red           |                                                                                                                                                                                                                                                                                                                                                                                                                                                                                                                                                                                                                                                                                                                                                                                                                          |
| Yellow        |                                                                                                                                                                                                                                                                                                                                                                                                                                                                                                                                                                                                                                                                                                                                                                                                                          |
| Blue          |                                                                                                                                                                                                                                                                                                                                                                                                                                                                                                                                                                                                                                                                                                                                                                                                                          |
| Green         |                                                                                                                                                                                                                                                                                                                                                                                                                                                                                                                                                                                                                                                                                                                                                                                                                          |
| Light blue    |                                                                                                                                                                                                                                                                                                                                                                                                                                                                                                                                                                                                                                                                                                                                                                                                                          |
| Purple        |                                                                                                                                                                                                                                                                                                                                                                                                                                                                                                                                                                                                                                                                                                                                                                                                                          |
| Pink          |                                                                                                                                                                                                                                                                                                                                                                                                                                                                                                                                                                                                                                                                                                                                                                                                                          |
| Close         |                                                                                                                                                                                                                                                                                                                                                                                                                                                                                                                                                                                                                                                                                                                                                                                                                          |

**Setting the drawing coordinate system**

- (1) Use the [↑] or [↓] key to move the cursor to the drawing coordinate settings column.
  - (2) Press the menu [Work coord].  
It is also possible to set input values.  
0 [INPUT]: Machine coord  
1 [INPUT]: Work coord
- ➔ "Work coord" appears at the cursor position.  
The cursor moves to the next line.  
A guide drawing with workpiece coordinate origin appears in the guide drawing area.

**Selecting the drawn workpiece coordinate system**

When the drawing coordinate system is the workpiece coordinate, the drawn coordinate system can be selected. Only the coordinate system selected here is drawn.

When the drawing coordinate system is the machine coordinate, "All Wk. Coord" (all workpiece coordinates) is set at "Coord Select" (workpiece coordinate system selection). Therefore, the menu [Coord G54-G59] or [Coord G54.1P] cannot be selected.

(Example) When "Coord G54-G59" is selected

- (1) Use the [↑] or [↓] key to move the cursor to "Coord Select" column.
  - (2) Press the menu [Coord G54-G59].
  - (3) Press the menu [G56].  
When the menu [Return] is selected, return to the menu [Coord Select].
- ➔ The sub-menus, which select G54 to G59, are displayed.
- ➔ "G56" appears at the cursor position.  
The cursor moves to the next line.  
The sub-menus of the material shape (WorkForm) are displayed.

**Note**

- (1) The drawing coordinate system settings of 2D and 3D graphic check are not linked.

**Setting the material shape (Work Form)**

- (1) Use the [↑] or [↓] key to move the cursor to the material shape settings column.
  - (2) Press the menu [Block].  
It is also possible to set input values.  
0 [INPUT]: Default shape  
1 [INPUT]: Block
- ➔ "Block" appears at the cursor position.  
The cursor moves to the next line.  
A block guide drawing appears in the guide drawing area.

**Selecting material zero point No.**

- (1) Use the [↑] or [↓] key to move the cursor to the setting column of "Work Ref Point No".
  
- (2) Input "5" and press the [INPUT] key. ➡ "5" appears at the cursor position.  
The cursor moves to the next line.  
 Input the value to set.  
 0 [INPUT]: Material zero point 0  
 1 [INPUT]: Material zero point 1  
 2 [INPUT]: Material zero point 2  
 3 [INPUT]: Material zero point 3  
 4 [INPUT]: Material zero point 4  
 5 [INPUT]: Material zero point 5  
 6 [INPUT]: Material zero point 6  
 7 [INPUT]: Material zero point 7  
 8 [INPUT]: Material zero point 8

**Note**

- (1) Set the value in the range of 0 to 8 in "Work Ref Point No". If you set "0" to the "Work Ref Point No", the behavior is the same as the one when the zero point "5" is selected.
- (2) If a value outside of the setting range is input, the operation message "Setting error" is displayed not to be set.

**Setting the material zero point shift (I coordinates)**

Set the shift amount between the zero point of the coordinate system and zero point of the workpiece. The shift amount to be set differs as follows, depending on the type of the coordinate system selected on the workpiece shape setting screen. When the basic machine coordinate system is selected, set the shift amount from the machine coordinate zero point. When the workpiece coordinate system is selected, set the shift amount from the machine coordinate zero point.

- (1) Use the [↑] or [↓] key to move the cursor to the setting column of "Work Ref Pnt Sft I".
  
- (2) Input data. ➡ "100.000" appears at the cursor position.  
The cursor moves to the next line.  
 (Example) 100 [INPUT]
  
- (3) Set the data for the other zero points and the widths of the workpiece in the same way.

**Note**

- (1) The setting ranges of the material zero point are as follows.

| #1003 Input setup unit | #1041 I_inch                  |                               |
|------------------------|-------------------------------|-------------------------------|
|                        | 0 (mm)                        | 1 (inch)                      |
| B                      | -99999.999 to 99999.999       | -9999.9999 to 9999.9999       |
| C                      | -99999.9999 to 99999.9999     | -9999.99999 to 9999.99999     |
| D                      | -99999.99999 to 99999.99999   | -9999.999999 to 9999.999999   |
| E                      | -99999.999999 to 99999.999999 | -9999.9999999 to 9999.9999999 |

- (2) If the position of the workpiece drawing zero point (material zero point) exceeds the above setting range due to the setting values of the material zero point shift and the width, the workpiece drawing zero point is converted to the maximum or minimum value of the setting range.

**Setting the material width (in I axis direction)**

Set the material width in millimeters in the millimeter system, and in inches in the inch system.

- (1) Use the [↑] or [↓] key to move the cursor to the setting column of "Work With I".
- (2) Input data. ➡ "100.000" appears at the cursor position.  
 (Example) 100 [INPUT] The cursor moves to the next line.
- (3) Set the other width data in the same way.

**Note**

- (1) If "0" or a value outside of the range is set for the material width, the workpiece of the default size (width I = 100.000, width J = 100.000, width K = 50.000) is displayed.
- (2) The setting ranges of the material width are as follows:

| #1003 Input setup unit | #1041 I_inch      |                   |
|------------------------|-------------------|-------------------|
|                        | 0 (mm)            | 1 (inch)          |
| B                      | 0 to 99999.999    | 0 to 9999.9999    |
| C                      | 0 to 99999.9999   | 0 to 9999.99999   |
| D                      | 0 to 99999.99999  | 0 to 9999.999999  |
| E                      | 0 to 99999.999999 | 0 to 9999.9999999 |

- (3) If the position of the workpiece drawing zero point (material zero point) exceeds the above setting range due to the setting values of the material zero point shift and the width, the workpiece drawing zero point is converted to the maximum or minimum value of the setting range.

**Setting the material color (WorkColor)**

- (1) Use the [↑] or [↓] key to move the cursor to the material color setting column.
- (2) Press the material color menu. ➡ The cell where the cursor is located appears in gray.  
 (Example) Menu [Gray] The cursor moves to the next line. (The cursor does not move when at the interference color.)  
 It is also possible to set input values.  
 0 [INPUT]: Default shape  
 1 [INPUT]: Gray  
 2 [INPUT]: Red  
 3 [INPUT]: Yellow  
 4 [INPUT]: Blue  
 5 [INPUT]: Green  
 6 [INPUT]: Light blue  
 7 [INPUT]: Purple  
 8 [INPUT]: Pink

- (3) Set the other color data in the same way.  
 <Note>  
 ♦The following colors are used if the default colors are designated.  
 Material color: Gray  
 Machining surface color: Yellow  
 Tap machining surface color: Light blue  
 Interference surface color: Red

**Difference of drawing depending on the combination of the menus for "Coordinate System" and "Coord Select"**

The drawing of 3D check changes as follows depending on the combination of the selected menus when the cursor is on "Coordinate System" and "Coord Select"

(Example)

|                                                                                                                                                                                                                                                                                                                                                                                              |                                                                                                                                                                                                                                                                                                                       |
|----------------------------------------------------------------------------------------------------------------------------------------------------------------------------------------------------------------------------------------------------------------------------------------------------------------------------------------------------------------------------------------------|-----------------------------------------------------------------------------------------------------------------------------------------------------------------------------------------------------------------------------------------------------------------------------------------------------------------------|
| <p>[Parameter]<br/>#8920= 1</p> <p>[Tool compensation]<br/>No.1: Length 150.000 L wear 0.000<br/>Radius 20.000 R wear 0.000</p> <p>[Workpiece coordinate system]<br/>G59: X 50.000 Y 50.000 Z 0.000<br/>G54.1P1: X 200.000 Y 200.000 Z 0.000</p> <p>[Workpiece shape setting]<br/>Work Ref Point (I,J,K) = (0.000, 0.000, -200.000)<br/>Work Width (I,J,K) = (500.000, 500.000, 100.000)</p> | <p>[Machining program]<br/>N1 G28 XYZ ;<br/>N2 T1 M6 ;<br/>N3 G43 H1 ;<br/>N10 G0 G90 G59 X100. Y100. Z0. ;<br/>N11 G91 G01 Z-200. F100 ;<br/>N12 G02 I-15 ;<br/>N13 G01 Z200. ;<br/>N20 G0 G90 G54.1 P1 X200. Y200. Z0. ;<br/>N21 G91 G01 Z-200. F100 ;<br/>N22 G02 I-15 ;<br/>N23 G01 Z200. ;<br/>M30 ;<br/>% ;</p> |
|----------------------------------------------------------------------------------------------------------------------------------------------------------------------------------------------------------------------------------------------------------------------------------------------------------------------------------------------------------------------------------------------|-----------------------------------------------------------------------------------------------------------------------------------------------------------------------------------------------------------------------------------------------------------------------------------------------------------------------|

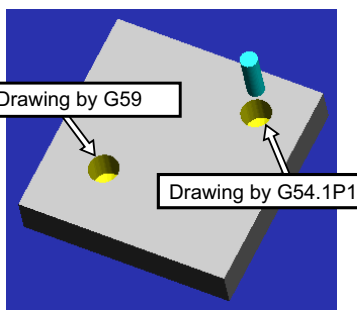
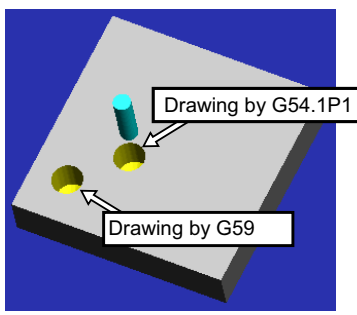
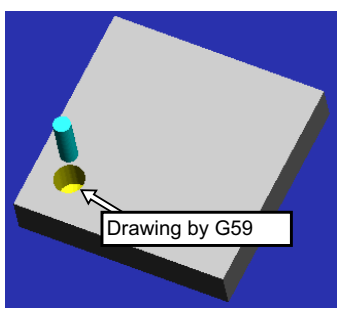
| Coordinate system | Coord Select  | Drawing result when 3D check in example                                             |                                                                                                                                                                                                                             |
|-------------------|---------------|-------------------------------------------------------------------------------------|-----------------------------------------------------------------------------------------------------------------------------------------------------------------------------------------------------------------------------|
| Machine coord     | All wk. coord |   | <p>Arranges the workpiece based on the machine coordinate zero point. Both workpiece coordinate systems G59 and G54.1P1 are drawn.</p>                                                                                      |
| Work coord        | All wk. coord |  | <p>Arranges the workpiece based on the workpiece coordinate zero point which is selected at the check execution. Both workpiece coordinate systems G59 and G54.1P1 are drawn.</p>                                           |
| Work coord        | G59           |  | <p>Arranges the workpiece based on the workpiece coordinate zero point which is selected at the check execution. Only draws the workpiece coordinate system G59. The workpiece coordinate systems G54.1P1 is not drawn.</p> |

#### 4.2.11 Setting the Tool Shape



Press the menu [Tool setting] to display the tool management screen. Set the tool shape used in the solid display for graphic check on the tool management screen.

Even though the menu [T-Mng.] is pressed on the [Setup] screen, the same screen can be displayed. For details, refer to "6.5 Setting the Tool Management Data (Tool Management Screen)".

#### 4.2.12 Setting the Drawing Speed of Program Check

Check speed of graphic check can be accelerated. When accelerating, set the parameter "#8997 Hi-speed grph chck" to "1" to "3" (Level 1 to Level 3). However, the shape of workpiece drawing becomes the one taking inner route than the path commanded by the program.

When you want to confirm the shape with high-accuracy, disable the high-speed graphic check.

| High-speed graphic check invalid                                                                                                                                                                 | High-speed graphic check valid                                                                                                                                                                |
|--------------------------------------------------------------------------------------------------------------------------------------------------------------------------------------------------|-----------------------------------------------------------------------------------------------------------------------------------------------------------------------------------------------|
| <p data-bbox="213 748 735 801">The shape can be confirmed with high-accuracy.<br/>The check speed is low.</p>  | <p data-bbox="810 748 1278 801">The check can be performed at high-speed.<br/>Minute shape collapses.</p>  |

#### Note

- (1) The setting of high-speed graphic check is not reflected while [Check continu] or [Check step] is operated in the background.
- (2) High-speed graphic check is valid only for check method I.

4.2.13 Drawing Travel Command of the Rotary Axis (Check Method II)

With check method II, the travel command of the rotary axis can be drawn. This chapter explains how to draw the travel command of the rotary axis.

**Drawing travel command of the rotary axis on tool-side**

Only tool tip is drawn.

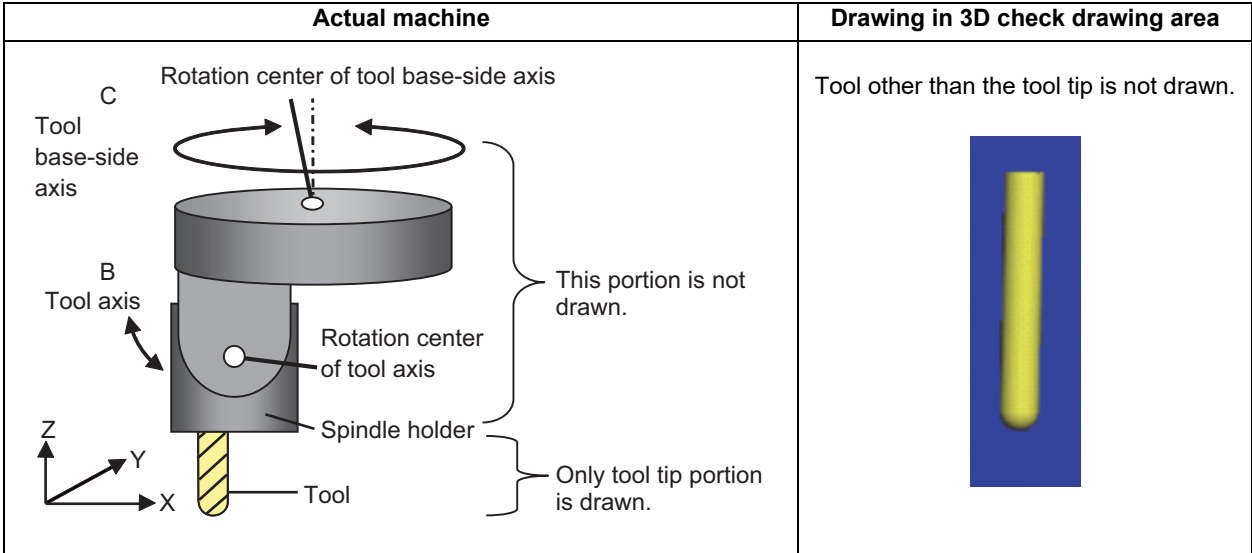

**[Drawing travel command of tool base-side axis]**

The travel command of the tool base-side axis is drawn based on the setting of the following rotary axis configuration parameters.

| Parameter No. | Name    | Details                                |
|---------------|---------|----------------------------------------|
| 7920          | SLCT_T1 | Rotary axis selection                  |
| 7922          | ROTAXT1 | Rotary axis name                       |
| 7923          | DIR_T1  | Rotation direction                     |
| 7924          | COFST1H | Horizontal axis rotation center offset |
| 7925          | COFST1V | Vertical axis rotation center offset   |
| 7926          | COFST1T | Height axis rotation center offset     |

**[Drawing travel command of tool axis]**

The travel command of the tool axis is drawn based on the setting of the following rotary axis configuration parameters.

| Parameter No. | Name    | Details                                |
|---------------|---------|----------------------------------------|
| 7930          | SLCT_T2 | Rotary axis selection                  |
| 7932          | ROTAXT2 | Rotary axis name                       |
| 7933          | DIR_T2  | Rotation direction                     |
| 7934          | COFST2H | Horizontal axis rotation center offset |
| 7935          | COFST2V | Vertical axis rotation center offset   |
| 7936          | COFST2T | Height axis rotation center offset     |

**Drawing travel command of table-side rotary axis**

The workpiece placed on the table is drawn, but the table itself is not drawn. Only one workpiece is drawn.

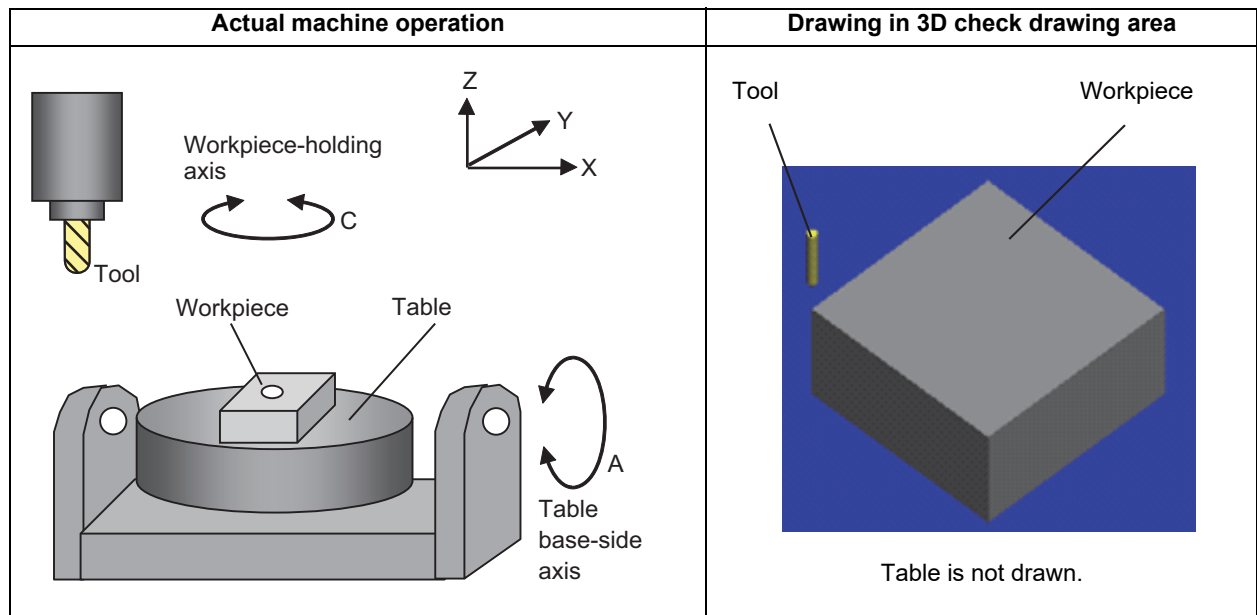

**[Drawing travel command of table base-side axis]**

The travel command of the table base-side axis is drawn based on the setting of the following rotary axis configuration parameters.

| Parameter No. | Name    | Details                                |
|---------------|---------|----------------------------------------|
| 7940          | SLCT_W1 | Rotary axis selection                  |
| 7942          | ROTAXW1 | Rotary axis name                       |
| 7943          | DIR_W1  | Rotation direction                     |
| 7944          | COFSW1H | Horizontal axis rotation center offset |
| 7945          | COFSW1V | Vertical axis rotation center offset   |
| 7946          | COFSW1T | Height axis rotation center offset     |

When the travel command is issued for the table base-axis, the tool moves while the workpiece appears to stand still.

**[Drawing travel command of the workpiece-holding axis]**

The travel command of the workpiece-holding axis is drawn based on the setting of the following rotary axis configuration parameters.

| Parameter No. | Name    | Details                                |
|---------------|---------|----------------------------------------|
| 7950          | SLCT_W2 | Rotary axis selection                  |
| 7952          | ROTAXW2 | Rotary axis name                       |
| 7953          | DIR_W2  | Rotation direction                     |
| 7954          | COFSW2H | Horizontal axis rotation center offset |
| 7955          | COFSW2V | Vertical axis rotation center offset   |
| 7956          | COFSW2T | Height axis rotation center offset     |

When the travel command is issued for the workpiece-holding axis, the tool moves while the workpiece appears to stand still.



**Drawing travel command during tool center point control/inclined surface machining command**

**[Drawing travel command during tool center point control]**

The drawing is as follows based on tool center point control valid (G43.4, G43.5) or tool center point control invalid (G49).

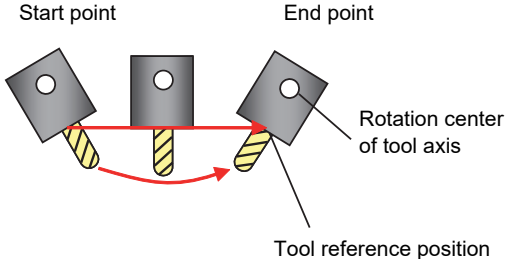
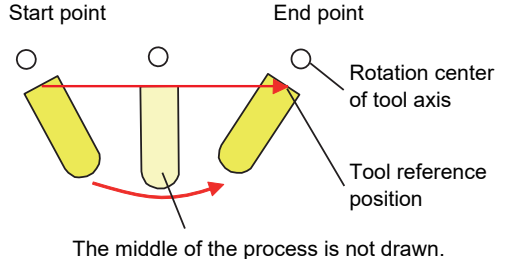
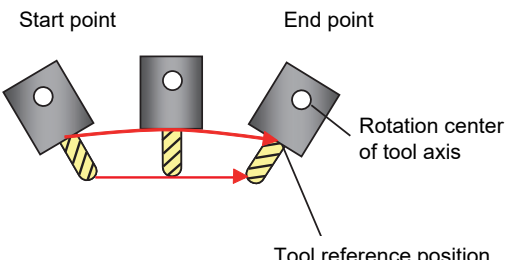
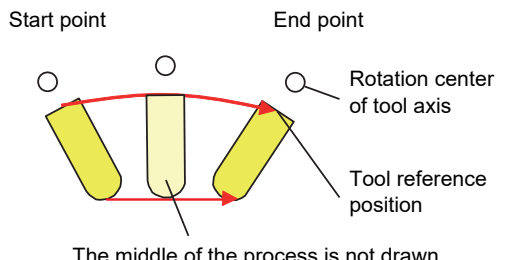
| Tool center point control | Actual machine operation                                                                                                                                                                                                                               | Drawing of 3D check                                                                                                                                                                                                                                        |
|---------------------------|--------------------------------------------------------------------------------------------------------------------------------------------------------------------------------------------------------------------------------------------------------|------------------------------------------------------------------------------------------------------------------------------------------------------------------------------------------------------------------------------------------------------------|
| Invalid (G49)             | <p>The position commanded with the machining program moves so that it becomes the tool base position.</p>                                                             | <p>The position commanded with the machining program is drawn so that it becomes the tool base position.</p>                                                             |
| Valid (G43.4, G43.5)      | <p>The position commanded with the machining program moves so that it becomes the center of tool tip on the coordinate system which rotates with the workpiece.</p>  | <p>The position commanded with the machining program is drawn so that it becomes the center of tool tip on the coordinate system which rotates with the workpiece.</p>  |

**[Drawing travel command during inclined surface machining command]**

The drawing during the inclined surface machining is as follows.

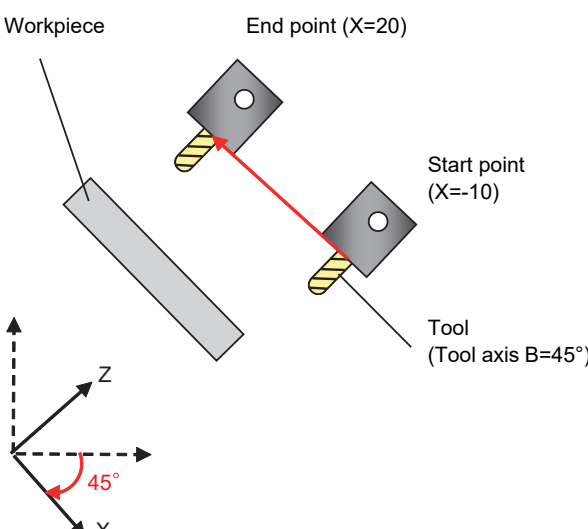
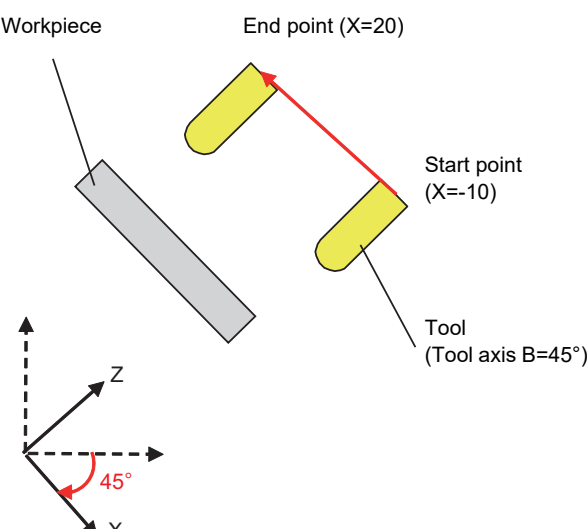
| Actual machine operation                                                                                                                                                | Drawing of 3D check                                                                                                                                                      |
|-------------------------------------------------------------------------------------------------------------------------------------------------------------------------|--------------------------------------------------------------------------------------------------------------------------------------------------------------------------|
| <p>The axis moves on the inclined coordinate system (feature coordinate system)</p>  | <p>The axis moves on the inclined coordinate system (feature coordinate system)</p>  |

## 4.2.14 Availability of Check Mode with Other Functions

It is important to be aware that certain NC parameters, program commands, and machine operation panel switches cannot be used while performing a program check.

| Function name                                   | Remarks                                                                                                                                                                                                                                                                                                                                                                                                                                  |
|-------------------------------------------------|------------------------------------------------------------------------------------------------------------------------------------------------------------------------------------------------------------------------------------------------------------------------------------------------------------------------------------------------------------------------------------------------------------------------------------------|
| Decimal point programming                       | Both decimal point input type I and II are valid.                                                                                                                                                                                                                                                                                                                                                                                        |
| Mirror Image                                    | A mirror image is applied and a check drawing is made at the setting status prior to starting the check.                                                                                                                                                                                                                                                                                                                                 |
| Mirror image by external input                  | [Check method I (Foreground), Check method II]<br>The signal is reflected, and check a drawing is carried out.<br>[Check method I (Background)]<br>The signal is ignored, and check a drawing is carried out.                                                                                                                                                                                                                            |
| Z axis command cancel                           | Signals are ignored and a check drawing is made.                                                                                                                                                                                                                                                                                                                                                                                         |
| Interlock                                       | Signals are ignored and a check drawing is made.                                                                                                                                                                                                                                                                                                                                                                                         |
| External deceleration                           | Signals are ignored and a check drawing is made.                                                                                                                                                                                                                                                                                                                                                                                         |
| Override                                        | Signals are ignored and a check drawing is made.<br>A check drawing is performed with override fixed at 100% ignoring the signals (check method II).                                                                                                                                                                                                                                                                                     |
| Auto operation pause (feed hold)                | Signals are ignored and a check drawing is made.                                                                                                                                                                                                                                                                                                                                                                                         |
| Auto operation start-up (cycle start)           | If you press the cycle start button during checking, the operation alarm "M01 program check mode" is displayed (check method I (foreground) or check method II) while the button is held down.<br>The operation can be started automatically even during check drawing (check method I (background)).                                                                                                                                    |
| Auto-restart                                    | The check is completed at M02/M30 and is not restarted.                                                                                                                                                                                                                                                                                                                                                                                  |
| Single block                                    | A check drawing is performed ignoring the signals (check method II).                                                                                                                                                                                                                                                                                                                                                                     |
| Manual arbitrary reverse run                    | A check drawing is performed ignoring the signals (check method II).                                                                                                                                                                                                                                                                                                                                                                     |
| High-speed simple program check                 | A check drawing is performed ignoring the signals (check method II).                                                                                                                                                                                                                                                                                                                                                                     |
| Tool life management                            | The tool life data count is not performed (check method II).                                                                                                                                                                                                                                                                                                                                                                             |
| Skip (G31)                                      | The skip signal is disabled. A drawing moves to the end point and is completed (check method II).                                                                                                                                                                                                                                                                                                                                        |
| Workpiece coordinate offset                     | Offset is enabled (the target is drawn at the position determined with the designated offset amount).                                                                                                                                                                                                                                                                                                                                    |
| Manual mode/handle                              | If the mode is switched to the manual mode during checking, the operation alarm "M01 program check mode" is displayed (check method I (foreground) or check method II).<br>During checking, you can switch to the manual mode, HANDLE, to move the machine. However, the drawing position of the check is not affected by the mode change (check method I (background)).                                                                 |
| Tape operation and MDI operation                | If the mode is switched to the manual mode during checking, the operation alarm "M01 program check mode" is displayed (check method II).                                                                                                                                                                                                                                                                                                 |
| F1-digit Feed                                   | The speed does not affect the check drawing with check method I.                                                                                                                                                                                                                                                                                                                                                                         |
| User macro I, II                                | Basic variable calculations, decisions and branch functions are all enabled.<br>However, the following functions are ignored.<br>•Macro interface input/output<br>•Single block stop<br>•Miscellaneous function complete signal waiting control<br>•Feed hold<br>•Feedrate override<br>•G09 enabled/disabled control<br>•Reading of position information for other than the previous block end point coordinates                         |
| M, S, T and 2nd miscellaneous function commands | M, S, T and 2nd miscellaneous function command signals commanded by the program during the check are not output. Neither do they display on the operation screen etc. The auxiliary function command by manual operation on the position display screen is output even during checking.<br>With the setting of the parameter "#1284 ext20/bit3", not outputting/outputting the miscellaneous function can be switched (check method II). |

| Function name                                     | Remarks                                                                                                                                                                                                                                                                                                                                                                                                               |
|---------------------------------------------------|-----------------------------------------------------------------------------------------------------------------------------------------------------------------------------------------------------------------------------------------------------------------------------------------------------------------------------------------------------------------------------------------------------------------------|
| G command modal                                   | G modal displays on the modal display screen while the check drawing is being made.<br>The modal information after the check cannot be returned to the state before the check (check method II).                                                                                                                                                                                                                      |
| Optional Block Skip                               | The setting status when starting the check drawing are used (check method I (foreground) or check method II).<br>Use the menu to switch ON and OFF. The optional block skip state is held until the power is turned ON again, which is common to part systems. However, when the power is turned ON again, the mode is always turned OFF (check method I (background)).                                               |
| Spindle position control (Spindle/C axis control) | Set the spindle position control (spindle/C axis control) for the part system to be checked to spindle mode, then execute a program check. Executing the check in C axis mode causes the operation error "M01 SP-C ax ctrl runs independently 1026", and the check cannot be started. (Check method II)<br>When the program command method is selected, the spindle/C axis moves in the C axis mode. (Check method I) |

**Note**

(1) Reference position return and start position return

The reference position return command and start position return command are valid, but actual machine motion (trace display) is partially different from the drawing by program check.

As shown in the figure below, when returning to the reference position via the intermediate point with the G28 or G30 command, positioning to the intermediate point is done by a straight line and positioning from there to the reference position is done by each axis independently.

With the G29 command, positioning to the intermediate point is done by each axis independently.

Under program checking, however, positioning is always done by a straight line even when returning via the intermediate point. This may cause a little difference from the trace display.

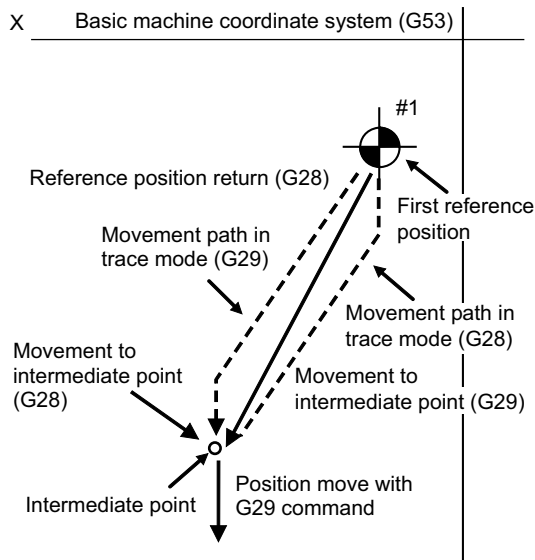

#### 4.2.15 Handling of Variable Commands, Programmable Parameter Input, and Programmable Compensation Data Input

If a program check is performed for a machining program for which the variable command data etc. is rewritten, all data types are treated as shown in the following table after completion. The setting commands, which are executed to various data during program check, are reflected on only drawing of background check. The actual machining operation is not affected.

Handling of variables, parameter and compensation amount (check method I (foreground))

| Data type                          | Returning to pre-checked data after check completion | Details                                                                                                                                                                                                                                                                                            |
|------------------------------------|------------------------------------------------------|----------------------------------------------------------------------------------------------------------------------------------------------------------------------------------------------------------------------------------------------------------------------------------------------------|
| Parameters                         | ×                                                    | The programmable parameter input commands are set as actual data.<br>(The data before the check is not saved.)                                                                                                                                                                                     |
| Local Variables                    | ○ / ×                                                | It is possible to return to the status prior to starting the program check based on the value of the parameter "#1231 set03/bit0" (Graphic check compatibility parameter).<br>0: Returns to original status after check completion<br>1: Does not return to original status after check completion |
| Common variable                    | ○ / ×                                                |                                                                                                                                                                                                                                                                                                    |
| Workpiece coordinate system offset | ○ / ×                                                |                                                                                                                                                                                                                                                                                                    |
| Tool compensation amount           | ○ / ×                                                |                                                                                                                                                                                                                                                                                                    |

Handling of variables, parameter and compensation amount (check method I (background))

| Data type                          | Returning to pre-checked data after check completion | Details                                                                                                                                             |
|------------------------------------|------------------------------------------------------|-----------------------------------------------------------------------------------------------------------------------------------------------------|
| Parameters                         | ○                                                    | The parameter input commands which have been executed at the program check are not set as actual data.<br>(The data before the check is not saved.) |
| Local Variables                    | ○                                                    | The parameter "#1231 set03/bit0" (Graphic check compatibility parameter) is disabled.                                                               |
| Common variable                    | ○                                                    |                                                                                                                                                     |
| Workpiece coordinate system offset | ○                                                    |                                                                                                                                                     |
| Tool compensation amount           | ○                                                    |                                                                                                                                                     |

Handling of variables, parameter and compensation amount (check method II)

| Data type                          | Returning to pre-checked data after check completion | Details                                                                                                        |
|------------------------------------|------------------------------------------------------|----------------------------------------------------------------------------------------------------------------|
| Parameters                         | ×                                                    | The programmable parameter input commands are set as actual data.<br>(The data before the check is not saved.) |
| Local Variables                    | ×                                                    | The parameter "#1231 set03(bit0)" (Graphic check compatibility parameter) is disabled.                         |
| Common variable                    | ×                                                    |                                                                                                                |
| Workpiece coordinate system offset | ×                                                    |                                                                                                                |
| Tool compensation amount           | ×                                                    |                                                                                                                |

## 4.2.16 Notes for Graphic Check (3D)

- (1) The check function is valid for only NC internal operation results. Thus, the path is not drawn for the command which requires machine movement.
- (2) For the handling of various types of data being set in the program, refer to "4.2.15 Handling of Variable Commands, Programmable Parameter Input, and Programmable Compensation Data Input".
- (3) "Program check completed" appears with M02/M30 command.
- (4) Graphic check is not available for serial and MDI program.
- (5) Operation search is available for a program that has a file name consisting of up to 32 characters. Operation search is not available for the program whose file name is consist of 33 characters or more.
- (6) When the check is executed, the drawing starts from the machine coordinate zero point. However, the machine coordinate zero point is (0, 0, 0) even when the value is set to the parameter "#2037 G53ofs" (zero point return).
- (7) The drawing coordinate system settings of 2D and 3D graphic check are not linked.
- (8) The origin mark is not drawn on the 3D drawing parts.
- (9) If the screen is switched during checking, the check reset occurs and the check is interrupted.
- (10) If tracing is turned ON during automatic operation, the menus such as [Check Search], [Check Continue], [Check Step], and [Check Reset] are grayed out. You cannot perform 3D solid check.
- (11) The drawing is not initialized even if the performance such as enlarge, reduce, move, change display mode, or rotate is set during check drawing. The program does not stop, either.
- (12) If the part system is switched during checking, the check is reset.
- (13) The tool shape is drawn according to the parameter "#8920 3D tool ofs select" parameter and according to the compensation amount (radius and length) (corresponding to the T command number) and the values (tool radius, tool length, and shape data 1 and 2) being set on the 3D Tool Shape setting screen.  
Therefore, if the tool length or compensation number being assigned during tool radius compensation differs from the T command number, a misalignment occurs between the tool shape and machine position, resulting in the 3D workpiece being machined excessively or not enough.
- (14) When the tool change is specified and if the following data of the tool corresponding to the T number is zero, the tool is drawn as the default tool.
  - If the tool type is not specified: Drill tool
  - If the tool length is 0: 150-mm tool length
  - If tool radius is 0: 20-mm tool radius
  - If shape data 1 is 0: 1-mm shape data 1 (it is 5 mm for the tap of tool type)
  - If shape data 2 is 0: 1-mm shape data 2 (Tool diameter x 0.05 mm for the tap of tool type)
  - If the color is not designated: Red tool
- (15) If the parameter "#8920 3D tool ofs select" is set to "0" or "1" and if the tool radius to be displayed is 0 or less, the 20-mm default tool radius is assumed and drawn.
- (16) If the fine segment program or complex shape program is executed for 3D checking, the "Solid check disabled (memory shortage)" message is displayed and the drawing may be erased. In such case, divide the program into subprograms and repeat check drawing. Before starting check drawing, press the menu [Initialize Workpiece] once.
- (17) If the coordinate system is set to "Work Coord", the workpiece coordinate position is not changed even when a coordinate system switching command is included in the program that executes the program check. Therefore, the drawings may be overlapped and displayed.
- (18) If the coordinate system is set to "Work Coord" and if a coordinate system switching command is not included in the program that executes the program check, the currently specified coordinate system is used and, therefore, drawing is not executed. Make sure the coordinate system is specified in the program.
- (19) The "Tapped Color", that is the same as when the tapping tool is selected, is used on the "Work set" screen. Therefore, switching of the tap surface color and normal surface color depends on not G command but the selected tool. However, even with the tapping tool being selected, if it is moved in the arc or helical direction, the "Work Set" screen does not have the "Tapped Color".
- (20) During 3D check, the tap is drawn as a straight rod and the shape data is not reflected (refer to "4.2.11 Setting the Tool Shape").
- (21) When there is a table per part system, drawing is performed as if one workpiece is placed on the table of the part system that started the check. Multiple workpieces cannot be drawn simultaneously.
- (22) When the workpiece shape is changed from the external source such as another application, the drawing reflect to the workpiece shape on the 3D check screen by pressing the [Work setting] menu to display workpiece shape setting screen.

**Notes for check method I (foreground)**

- (1) If you press the cycle start button when an arbitrary part system is being checked, the operation alarm "M01 program check mode" is generated and the cycle start is disabled while the button is held down.  
Press the auto start button after the check is completed or after the check is stopped with the menu [Check reset].
- (2) If you carry out the operation search or check operation (continuous or step check) during cycle start or automatic stop of an arbitrary part system, an operation message "Executing automatic operation" is displayed, and no search or check drawing is carried out.
- (3) "Program check completed" appears with M02/M30 command. For the tape mode, the rewind process is not carried out.
- (4) The check ends with the reset (NC reset or the menu [Check reset]).  
When a program error occurs, cancel the error with the operation indicated above.  
If NC reset is selected when the check screen is being displayed, check drawing ends but the menu to switch to the 2D check or 3D check is kept invalid. To enable this switching, press the menu [Check reset].
- (5) During automatic operation, the contents of automatic operation program are displayed by the "Currently executed machining program" (ONB display) and "Buffer display" on the check screen. During checking, the contents of the checking program are displayed by the "Currently executed machining program" (ONB display) and "Buffer display" on the monitor screen.
- (6) If you carry out the operation search or check operation (continuous or step check) when the program is restarted, the "Program restarting" operation message is displayed, and no search or check drawing is carried out.
- (7) If the manual operation mode is selected during checking, the "M01 program check mode" is displayed and the axis cannot be moved. If you need to move the axis, temporarily stop the current check by executing a reset and then move the axis. When you switch from the manual operation mode to the memory mode, the alarm is released. You can continue the current check even if an alarm is output.
- (8) When the PLC Interrupt signal is turned ON during checking, the "M01 Program check mode" is selected. To start the PLC interrupt, terminate the current check by executing a reset. When you turn the PLC interrupt signal OFF, the alarm is released. You can continue the current checking even if the PLC Interrupt signal is ON.
- (9) On the maintenance screen, when the rotary axis configuration parameter is changed to display 3D check screen, the machining result of the workpiece is initialized.
- (10) This does not support the dynamic switch of the rotary axis configuration parameter ("#1450 5axis\_Spec/bit2" (application of rotary axis configuration parameters)) by inclined surface machining command. The parameter set in the own part system at the start of 3D check is valid.
- (11) When the M01 is commanded with the menu [M0/M1 neglect] disabled, the drawing stops regardless of the state (ON or OFF) of the optional stop switch.

**Notes for check method I (background)**

- (1) The program that you have selected during Check Search is not the program that is executed during automatic operation. Search the program for automatic operation by using the operation search function of the monitor screen.
- (2) The parameters and compensation amount do not reflect on check drawing even if you set them during checking. To reflect them on the drawings, reset the check once. Then, press the menu [Check continu] or [Check step] and execute the check again.
- (3) "Program check completed" appears with M02/M30 command.
- (4) The check is not terminated via execution of a reset.  
If a program error occurs, release the error by selecting the menu [Check reset].
- (5) During check search, if the length of the full path name exceeds 48 characters, you cannot move to another directory.
- (6) If the menu [Optional Skip] is ON (highlighted), the blocks that have the "/" character are skipped and the T-code list is obtained.
- (7) The file name continues to be displayed as an O-number display even if you erase or rename the file after it is checked and searched. If you check a file in this status, the "Push [Check reset] menu" message is displayed.
- (8) During checking, if you read the integrated time by using variable number #3001 or #3002, the checking start time is obtained. You cannot write the integrated time.
- (9) When [Check continu] is executed, even if variable number #3006 is used for checking, you cannot stop the program and you cannot display the message.
- (10) When the M01 is commanded with the menu [M0/M1 neglect] disabled, the drawing stops regardless of the state (ON or OFF) of the optional stop switch.

**Notes for check method II**

- (1) If you press the cycle start button when an arbitrary part system is being checked, the operation alarm "M01 program check mode" is generated and the cycle start is disabled while the button is held down.  
Press the auto start button after the check is completed or after the check is stopped with the menu [Check reset].
- (2) If you carry out the operation search or check operation (continuous or step check) during cycle start or automatic stop of an arbitrary part system, an operation message "Executing automatic operation" is displayed, and no search or check drawing is carried out.
- (3) "Program check completed" appears with M02/M30 command. For the tape mode, the rewind process is not carried out.
- (4) The check ends with the reset (NC reset or the menu [Check reset]).  
When a program error occurs, cancel the error with the operation indicated above.  
If NC reset is selected when the check screen is being displayed, check drawing ends but the menu to switch to the 2D check or 3D check is kept invalid. To enable this switching, press the menu [Check reset].
- (5) During automatic operation, the contents of automatic operation program are displayed by the "Currently executed machining program" (ONB display) and "Buffer display" on the check screen. During checking, the contents of the checking program are displayed by the "Currently executed machining program" (ONB display) and "Buffer display" on the monitor screen.
- (6) If you carry out the operation search or check operation (continuous or step check) when the program is restarted, the "Program restarting" operation message is displayed, and no search or check drawing is carried out.
- (7) If the manual operation mode is selected during checking, the "M01 program check mode" is displayed and the axis cannot be moved. If you need to move the axis, temporarily stop the current check by executing a reset and then move the axis. When you switch from the manual operation mode to the memory mode, the alarm is released. You can continue the current check even if an alarm is output.
- (8) When the PLC Interrupt signal is turned ON during checking, the "M01 Program check mode" is selected. To start the PLC interrupt, terminate the current check by executing a reset. When you turn the PLC interrupt signal OFF, the alarm is released. You can continue the current checking even if the PLC Interrupt signal is ON.
- (9) If the value is rewritten by G10L70 (parameter command by program), system variables or common variables in the program being checked, the value is rewritten in the same manner as when the program is executed during automatic operation.
- (10) On the maintenance screen, when the rotary axis configuration parameter is changed to display 3D check screen, the machining result of the workpiece is initialized.
- (11) When the sub part system control I/II commands are executed, the program error (P803) occurs and the check is stopped.
- (12) During tap retract enable state, if the check operations ([Check continu] or [Check step]) is performed, "M01 Wait for tap retract 0057" is displayed and the check cannot be performed in the part system in which the alarm occurred. After the state becomes tap retract enable and tap retract enable operation is completed, the check can be performed.
- (13) When you use the arbitrary axis exchange control function, set all the part systems to be check targets for the graphic check (\*1). When any axis in the part system which is not to be checked is designated, the operation error "M01 Arbitrary axis unexchangeable 1101" occurs, the graphic check cannot be performed in the part system where an alarm is displaying. Change the setting of the parameter or change the machining program.  
  
(\*1) The part system which is set to "0" by any of the parameters "#8982 CheckSmltns\$1Invlid" to "#8989 CheckSmltns\$8Invlid"

**Full-screen display of graphic check function (3D)**

- (1) For 3D check, the drawn workpiece shape is enlarged or reduced to be 90% of drawing area in accordance with the size of graphic drawing area when the screen is switched between normal display and full-screen display.

**Setting for base axes**

When a rotary axis is included among the base axis parameters I, J, and K (#1026 to #1028), set the base axis parameters for graphics I, J, and K (#8631 to #8633) to exclude the rotary axis as the following example.

If all the base axis parameters for graphics I, J, and K are not set, the graphic check operates in accordance with the setting of the base axis parameters #1026 to #1028.

[Setting example of parameters]

Base axis parameter

| No.   | Parameter name | Setting value | Explanation |
|-------|----------------|---------------|-------------|
| #1026 | base_I         | X             | Linear axis |
| #1027 | base_J         | C             | Rotary axis |
| #1028 | base_K         | Z             | Linear axis |

Base axis parameter for graphics

| No.   | Parameter name     | Setting value | Explanation                               |
|-------|--------------------|---------------|-------------------------------------------|
| #8631 | GraphicsBaseAxis_I | X             | Set the same axis name as #1026.          |
| #8632 | GraphicsBaseAxis_J |               | Enter "0" to the rotary axis to be blank. |
| #8633 | GraphicsBaseAxis_K | Z             | Set the same axis name as #1028.          |

**Using the lathe turning tool**

Note the following points when the program check is performed using the lathe turning tool.

- (1) Set the tool so that the coordinates I and J of the material zero point in the [Work setting] are in the center of the work-piece.  
If the zero point is not in the center of the workpiece, the image of turning machining cannot be drawn correctly.

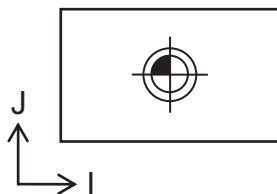

- (2) The machine configuration is as follows.

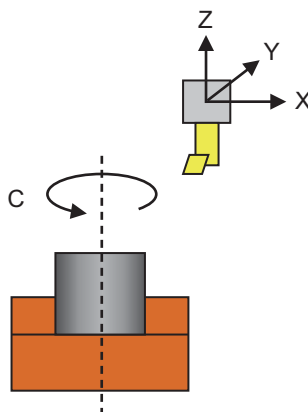

- (3) For the lathe turning tool, if the tool moves in the Y axis direction, the lathe turning cannot be performed and it does not reflect the machining shape of the workpiece. When the tool moves in the X axis and Z axis, the lathe turning can be performed and it reflects the machining shape of the workpiece.
- (4) The tools for lathe turning stored in the magazine can be replaced.



**Drawing position**

Set the drawing position with the parameter "#8920 3D tool ofs select" according to the tool length measurement type (I/II). The following table shows the drawing position and the diameter and length of the tool to be displayed based on the combination with the tool length measurement type (I/II).

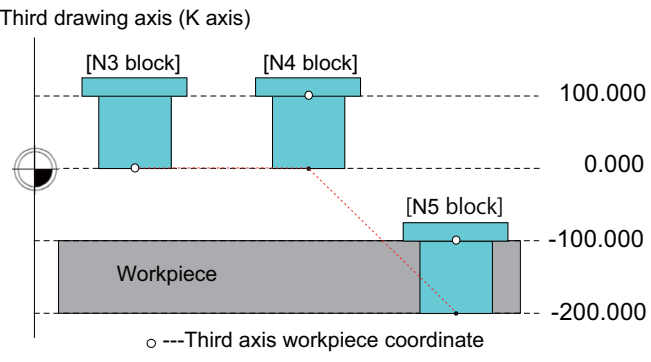
| Setting value of #8920                                                                                                                                                                                                                                                                                                                                                                                                                                                                                                                                                                                                                                                                                                                                                                                                                                                                                                                                                                                                                                                                                                                                                                               | Drawing position (X, Y, Z)                                                                                                                                                                                                                                                                                                                                                                                                   | Radius and length of tool to be displayed                                                                     |                                                                                                                                                         |                                                                                                                                    |
|------------------------------------------------------------------------------------------------------------------------------------------------------------------------------------------------------------------------------------------------------------------------------------------------------------------------------------------------------------------------------------------------------------------------------------------------------------------------------------------------------------------------------------------------------------------------------------------------------------------------------------------------------------------------------------------------------------------------------------------------------------------------------------------------------------------------------------------------------------------------------------------------------------------------------------------------------------------------------------------------------------------------------------------------------------------------------------------------------------------------------------------------------------------------------------------------------|------------------------------------------------------------------------------------------------------------------------------------------------------------------------------------------------------------------------------------------------------------------------------------------------------------------------------------------------------------------------------------------------------------------------------|---------------------------------------------------------------------------------------------------------------|---------------------------------------------------------------------------------------------------------------------------------------------------------|------------------------------------------------------------------------------------------------------------------------------------|
| 0 (For tool length measurement type I)<br>For tool radius compensation, the tool compensation amount set in the tool compensation screen is used.<br>For tool length, the data set in the 3D tool shape setting screen is used.                                                                                                                                                                                                                                                                                                                                                                                                                                                                                                                                                                                                                                                                                                                                                                                                                                                                                                                                                                      | X: Machine position<br>Y: Machine position<br>Z: Machine position                                                                                                                                                                                                                                                                                                                                                            | Radius: Tool radius compensation amount<br>Length: Tool length in the 3D tool shape setting screen            |                                                                                                                                                         |                                                                                                                                    |
| 1 (For tool length measurement type II)<br>For both tool radius and tool length, the tool compensation amount set in the tool compensation screen is used.                                                                                                                                                                                                                                                                                                                                                                                                                                                                                                                                                                                                                                                                                                                                                                                                                                                                                                                                                                                                                                           | X: Machine position<br>Y: Machine position<br>Z: Varies depending on the conditions below.<br>•During G43 (offset in positive (+) direction) modal<br>Machine position - (Tool length compensation amount + wear compensation amount)<br>•During G44 (offset in negative (-) direction) modal<br>Machine position + (Tool length compensation amount + wear compensation amount)<br>•G49 (Offset cancel)<br>Machine position | Radius: Tool radius compensation amount<br>Length: Tool length compensation amount + wear compensation amount |                                                                                                                                                         |                                                                                                                                    |
| <p>&lt;Example of the drawing position when #8920 = 1&gt;</p> <table border="0" style="width: 100%;"> <tr> <td style="width: 50%; vertical-align: top;">                     [Tool compensation amount screen]<br/>                     Number 50<br/>                     Length dimension: 110.000<br/>                     Length wear: -10.000<br/>                     Radius dimension: 60.000<br/>                     Radius wear: -10.000                 </td> <td style="width: 50%; vertical-align: top;">                     [Machining program]<br/>                     N1 G28 XYZ<br/>                     N2 T50 M6<br/>                     N3 G0 G90 G54 X100. Y100. Z0.<br/>                     N4 G43 Z0. H50.<br/>                     N5 G91 G01 Z-200. F100.<br/>                     :                 </td> </tr> </table> <p>[Radius and length of tool to be displayed]<br/>                     Length = 100.000 (110.000 + (-10.000))<br/>                     Radius = 50.000 (60.000 + (-10.000))</p>  <p style="text-align: center;">○ ---Third axis workpiece coordinate</p> |                                                                                                                                                                                                                                                                                                                                                                                                                              |                                                                                                               | [Tool compensation amount screen]<br>Number 50<br>Length dimension: 110.000<br>Length wear: -10.000<br>Radius dimension: 60.000<br>Radius wear: -10.000 | [Machining program]<br>N1 G28 XYZ<br>N2 T50 M6<br>N3 G0 G90 G54 X100. Y100. Z0.<br>N4 G43 Z0. H50.<br>N5 G91 G01 Z-200. F100.<br>: |
| [Tool compensation amount screen]<br>Number 50<br>Length dimension: 110.000<br>Length wear: -10.000<br>Radius dimension: 60.000<br>Radius wear: -10.000                                                                                                                                                                                                                                                                                                                                                                                                                                                                                                                                                                                                                                                                                                                                                                                                                                                                                                                                                                                                                                              | [Machining program]<br>N1 G28 XYZ<br>N2 T50 M6<br>N3 G0 G90 G54 X100. Y100. Z0.<br>N4 G43 Z0. H50.<br>N5 G91 G01 Z-200. F100.<br>:                                                                                                                                                                                                                                                                                           |                                                                                                               |                                                                                                                                                         |                                                                                                                                    |



**Drawing start position**

When the check is executed, the drawing starts from the position set in the parameter "#8217 Check start point".

The drawing is not operated between the check end position of last time and the check start position of this time.

[Check method I]

If reference position return is commanded during the check, the drawing start position moves to the position set in the parameter #8217.

[Check method II]

If reference position return is commanded during the check, the drawing start position moves to the position set in the zero point return parameter ("#2037 G53ofs" to "#2040 #4\_rfp").

**Note**

(1) With check method II, the drawing starts from the actual machine position when the check is executed.

## 4.3 Graphic Check (3D) (L System)



Graphic check (3D) is a function that allows you to check the machining program movement path only by drawing without automatic operations. Therefore, the graphics can be drawn at a high speed and high accuracy, and the machining program can be checked.

The turning machining and milling on the front and back sides of a workpiece can be drawn with 3D check of the graphic check function.

This function requires workpiece and tool shape settings.

### Note

(1) When changing the screen to the edit screen, display depends on the previous checking type (2D/3D). If 2D graphic data appears, press the menu [3D check]. Note that when transferring to this screen during graphic trace, 3D solid program check is displayed.

### [Terms]

The following descriptions are the meanings of the terms used in this chapter.

Foreground: Active state operated by the user such as automatic operation on the NC

Background: Inactive state operated in the back of foreground

**[Check method]**

There are two types of 3D graphic check as below, which can be switched by [Type change] menu.

**Note**

(1) Make sure to select the check method before the check is started. During the check, [Type change] menu is grayed out, and the check method cannot be changed.

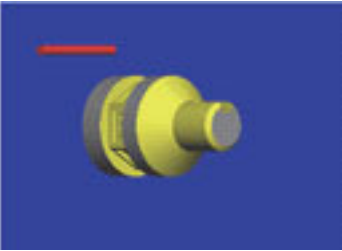
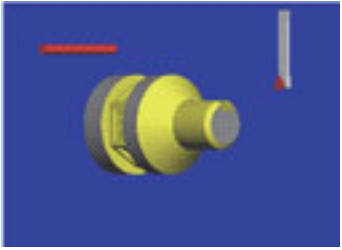
| Check method           | Outline of drawing                                                                                                                                                                                                                                                                                                                                        | Details                                                                                                                                                                                                                                                                                                                                                                                                                                                                                                                                                                                                                                                                                                                                                                                                                                                                      |
|------------------------|-----------------------------------------------------------------------------------------------------------------------------------------------------------------------------------------------------------------------------------------------------------------------------------------------------------------------------------------------------------|------------------------------------------------------------------------------------------------------------------------------------------------------------------------------------------------------------------------------------------------------------------------------------------------------------------------------------------------------------------------------------------------------------------------------------------------------------------------------------------------------------------------------------------------------------------------------------------------------------------------------------------------------------------------------------------------------------------------------------------------------------------------------------------------------------------------------------------------------------------------------|
| <p>Check method I</p>  | <p>This method simplifies the machining result of machining program and simulates at a high speed. A machining program in single part system (displayed part system) is drawn. In 3D drawing area, one workpiece and one tool are displayed.</p>                         | <p>This method is operated on the background on M800W, M800S and M80W. This method is operated on the foreground on M80 and E80.</p>                                                                                                                                                                                                                                                                                                                                                                                                                                                                                                                                                                                                                                                                                                                                         |
| <p>Check method II</p> | <p>This method simulates the machining result of machining program at a higher accuracy than check method I. Machining programs in multiple part systems can be drawn simultaneously. In 3D drawing area, one workpiece and tools for part systems are displayed.</p>  | <p>This method is available only when the operation mode in the part system to be simulated is in the memory mode.</p> <p>This method is operated on the foreground and in the machine lock status during the program check.</p> <p>Also, during the program check, the PLC signal (Graphic check (Check method II) in progress X759) is turned ON.</p> <p>The program check cannot be started during automatic operation in arbitrary part system.</p> <p>The program check is in operation from the program execution by pressing the menu [Check continu] or [Check step] on the check screen to the following status.</p> <ul style="list-style-type: none"> <li>♦Program ends.</li> <li>♦The menu [Check reset] is pressed.</li> <li>♦The reset signal or emergency stop signal outputs.</li> <li>♦The screen is moved from the check screen to another one.</li> </ul> |

•Check method I

In the 2-part system or more, press the part system switch key  to switch the display to the target part system before starting checking. Note that program check is carried out in the 2-part system or more regardless of the command such as the timing synchronization between a hidden part system and another part system.

•Check method II

In two or more part systems, regardless of the displayed part system, the programs following the setting of the parameters "#8982 CheckSmltns\$1Invlid" to "#8989 CheckSmltns\$8Invlid" are checked simultaneously.

Using the menu [All display], normal display and full-screen display modes can be switched.

**[Targets of drawing]**

The workpiece and tool that can be drawn with the program check per part system are as shown below:

|           | Check method I                                                                                                                    | Check method II                                                                                              |
|-----------|-----------------------------------------------------------------------------------------------------------------------------------|--------------------------------------------------------------------------------------------------------------|
| Workpiece | 1 workpiece<br>Based on the premise that the workpiece is machined by the front-side spindle and the back-side spindle at a time. |                                                                                                              |
| Tool      | 1 tool<br>The tool used in the currently displayed part system is drawn. The part system can be switched.                         | Up to 8 tools<br>The tool for the part system to be checked is drawn. Up to eight part systems can be drawn. |

**[Coordinate system during drawing]**

•Check method I

3D graphic is drawn based on the programming coordinate system by setting the zero points in the following positions.  
 X-axis zero point: Center of workpiece  
 Y-axis zero point: Fix to 0  
 Z-axis zero point: Workpiece zero point Z (Zero point can be designated respectively for the front side and back side.)

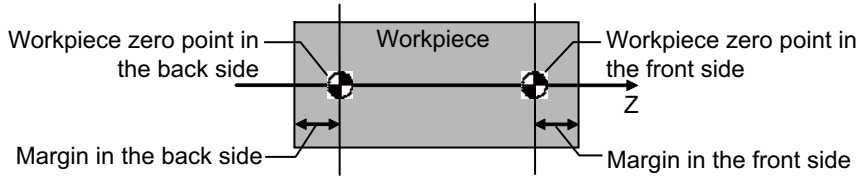

Refer to "4.3.10 Setting the Workpiece Shape" for details on setting the workpiece zero point Z.

•Check method II

3D drawing is drawn in the machine coordinate system with the machine zero point as zero point. Therefore, the settings of front-side workpiece zero point Z and rear-side workpiece zero point set on the workpiece shape setting screen are treated as invalid.

The machine zero point is designated with the parameter "#2144 baseps" (Base machine coordinate zero point relative distance).

The display position of workpiece when the check is started.

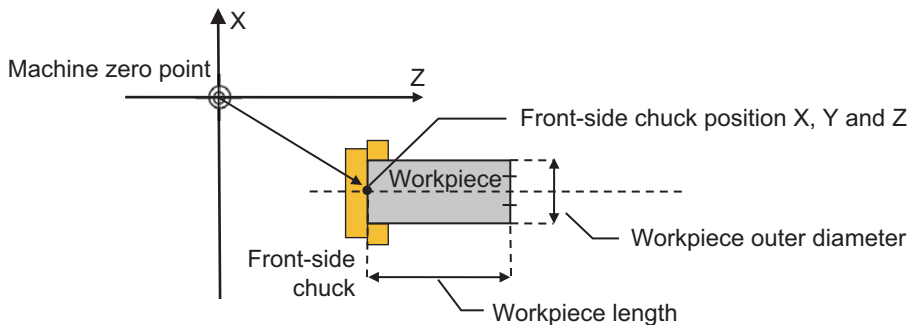

For the chuck position, the setting by the MTB is required.  
 The chuck is not drawn in the 3D drawing area.

**[Drawing shape of tool]**

Turning tools are always drawn according to the tool information in the tool management screen; however, the shape of milling tools is set via the parameter (#8920 3D tool ofs select).

The shape of milling tools is set via the parameter (#8920 3D tool ofs select) as shown below:

| "3D tool ofs select" parameter |                                                        | Radius and length of tool to be displayed                          |
|--------------------------------|--------------------------------------------------------|--------------------------------------------------------------------|
| 0                              | Tool radius: Tool compensation amount on the NC screen | Radius: Nose R compensation amount + wear compensation amount      |
|                                | Tool length: Data on the tool management screen        | Length: Tool length "A" on the tool management screen              |
| 1                              | Tool radius: Tool compensation amount on the NC screen | Radius: Nose R compensation amount + wear compensation amount      |
|                                | Tool length: Tool compensation amount on the NC screen | Length: Tool length compensation amount + wear compensation amount |
| 2                              | Tool radius: Data on the tool management screen        | Radius: Tool length "B" on the tool management screen              |
|                                | Tool length: Data on the tool management screen        | Length: Tool length "A" on the tool management screen              |

For the data on the tool management screen to be used for drawing tools, refer to "6.5 Setting the Tool Management Data (Tool Management Screen)".

■ Normal display ([All display] is OFF)

<Drawing area>

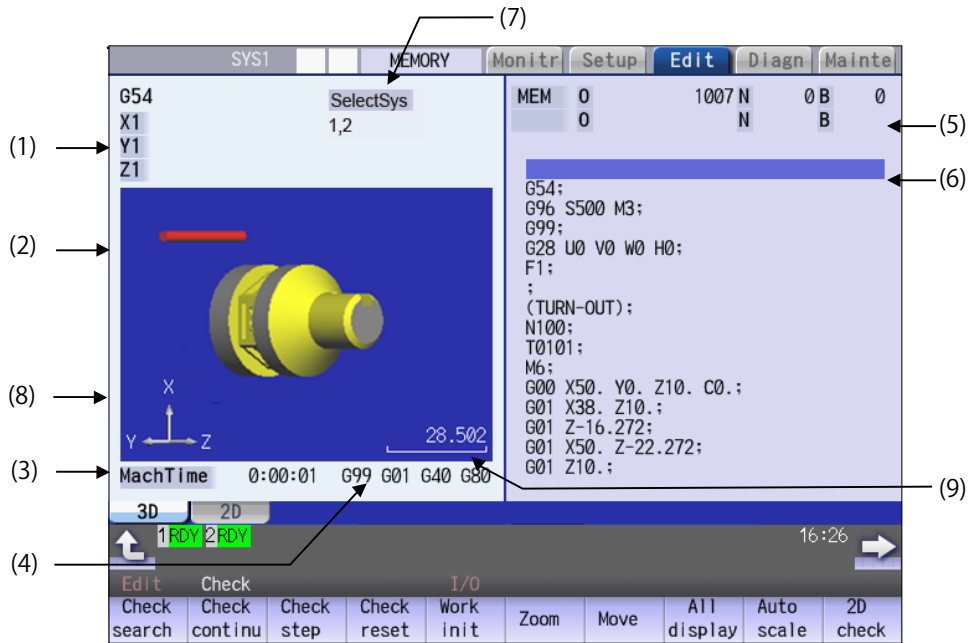

■ Full-screen display ([All display] is ON)

<Drawing area>





## Display items

| Display items |                                                  | Details                                                                                                                                                                                                                                                                                                                                                                                                                                                                                                                                                                                                                                                                          |                                                                                                                                                                                                                                                                   |
|---------------|--------------------------------------------------|----------------------------------------------------------------------------------------------------------------------------------------------------------------------------------------------------------------------------------------------------------------------------------------------------------------------------------------------------------------------------------------------------------------------------------------------------------------------------------------------------------------------------------------------------------------------------------------------------------------------------------------------------------------------------------|-------------------------------------------------------------------------------------------------------------------------------------------------------------------------------------------------------------------------------------------------------------------|
| (1)           | Check counter                                    | <p>This displays the axis counter for the check drawing.<br/>As for the axes name, system common axis name ("#1022 axname2") based on the basic axis name set by the parameters "#1026 base_I", "#1027 base_J", and "#1028 base_K" are displayed.</p> <p>[Check method I]</p> <p>This displays the workpiece coordinate counter for the current part system (the part system being checked).</p> <p>[Check method II]</p> <p>This displays the machine coordinate counter for the current part system (it is not necessarily the part system being checked).</p>                                                                                                                 |                                                                                                                                                                                                                                                                   |
| (2)           | 3D drawing area                                  | This area is used to display a solid graphic drawing of the workpiece shape and tool movement during the cutting process in the machining program. The drawing viewpoint can be moved, and the drawing size can be enlarged and reduced.                                                                                                                                                                                                                                                                                                                                                                                                                                         |                                                                                                                                                                                                                                                                   |
| (3)           | Machining time display                           | The time required for machining is calculated and displayed.                                                                                                                                                                                                                                                                                                                                                                                                                                                                                                                                                                                                                     |                                                                                                                                                                                                                                                                   |
| (4)           | G modal display for check                        | <p>The following items are displayed from the left.</p> <ul style="list-style-type: none"> <li>♦Feed per minute/Feed per revolution (G98, G99: Group 5)</li> <li>♦Operation mode (G00, G01, etc.: Group 1)</li> <li>♦Nose R compensation (G40, G41, G42: Group 7)</li> <li>♦Fixed cycle (G70 etc.: Group 9)</li> </ul> <p>However, the next modal in M system may be displayed due to the switching command of program format.</p> <ul style="list-style-type: none"> <li>♦Absolute/incremental (G90, G91: Group 3)</li> <li>♦Operation mode (G00, G01, etc.: Group 1)</li> <li>♦Tool compensation (G40, G41, G42: Group 7)</li> <li>♦Fixed cycle (G70 etc.: Group 9)</li> </ul> |                                                                                                                                                                                                                                                                   |
| (5)           | Currently executed machining program             | Main O10...                                                                                                                                                                                                                                                                                                                                                                                                                                                                                                                                                                                                                                                                      | This displays the device name, program No., sequence No., and block No. currently being executed.<br>When they exceed the displayable number of characters (12 characters), the excess is abbreviated and displayed (*).                                          |
|               |                                                  | Sub O1234...                                                                                                                                                                                                                                                                                                                                                                                                                                                                                                                                                                                                                                                                     | This displays the sub-program device name, program number, sequence number, and block number for the sub-program currently being executed.<br>When they exceed the displayable number of characters (12 characters), the excess is abbreviated and displayed (*). |
| (6)           | Buffer display                                   | This displays the contents of the machining program currently being executed.<br>The block being executed is highlighted.                                                                                                                                                                                                                                                                                                                                                                                                                                                                                                                                                        |                                                                                                                                                                                                                                                                   |
| (7)           | Part system to be checked (Check method II only) | This displays the part system to be checked (the part system for which the parameters "#8982 CheckSmltns\$1Invid" to "#8989 CheckSmltns\$8Invid" are set) (up to eight part systems).<br>This menu is displayed with check method II only.                                                                                                                                                                                                                                                                                                                                                                                                                                       |                                                                                                                                                                                                                                                                   |
| (8)           | Coord display                                    | This displays the coordinate system direction. This displays the axis direction of the base axis I/J/K with arrow.                                                                                                                                                                                                                                                                                                                                                                                                                                                                                                                                                               |                                                                                                                                                                                                                                                                   |
| (9)           | Scale display                                    | This shows the display range scale. The unit is set to "mm/80pixel" in millimeters and "inch/80pixel" in inches.                                                                                                                                                                                                                                                                                                                                                                                                                                                                                                                                                                 |                                                                                                                                                                                                                                                                   |

| Menus         |                                                                                                                                                                                                                                                                                                                                                                                                                                                                                                               |
|---------------|---------------------------------------------------------------------------------------------------------------------------------------------------------------------------------------------------------------------------------------------------------------------------------------------------------------------------------------------------------------------------------------------------------------------------------------------------------------------------------------------------------------|
| Menus         | Details                                                                                                                                                                                                                                                                                                                                                                                                                                                                                                       |
| Check search  | This performs a check search.<br>Select a program to be checked from the program file list displayed in the pop-up window.<br>For only the machining programs in NC memory, the check search is executed across all part systems in batch when the multi-part system program management is valid (#1285 ext21/bit0 =1, ext21/bit1 =1).                                                                                                                                                                        |
| Check continu | This checks the program continuously.                                                                                                                                                                                                                                                                                                                                                                                                                                                                         |
| Check step    | This checks the program per block.                                                                                                                                                                                                                                                                                                                                                                                                                                                                            |
| Check reset   | This resets the program check.                                                                                                                                                                                                                                                                                                                                                                                                                                                                                |
| Work init     | This initializes the workpiece shape. Displays the pre-machining workpiece shape set at the "Work set" window (workpiece shape setting). At this time, the cross-section status is canceled.                                                                                                                                                                                                                                                                                                                  |
| Zoom          | This enlarges/reduces the displayed workpiece shape.                                                                                                                                                                                                                                                                                                                                                                                                                                                          |
| Move          | This moves the displayed workpiece shape.                                                                                                                                                                                                                                                                                                                                                                                                                                                                     |
| All display   | This switches the normal display mode and the full-screen display mode.                                                                                                                                                                                                                                                                                                                                                                                                                                       |
| Auto scale    | This enlarges/reduces the unmachined workpiece shape (stored in the NC) to be approximately 90% of the graphic area, and also initializes the rotation.                                                                                                                                                                                                                                                                                                                                                       |
| 2D check      | This changes the program check (2D) display.<br>This menu cannot be selected while the check is performed or interrupted.                                                                                                                                                                                                                                                                                                                                                                                     |
| Colli check   | This enables or disables the interference check.<br>When the interference check is enabled, if the tool and workpiece contact each other when performing rapid traverse (G0) movement, the contact location is drawn in a color highlighting the interference.                                                                                                                                                                                                                                                |
| Opt Skip      | Select whether to execute a block that has a slash "/" in the program to be checked.<br>Selecting "ON" skips a block with a slash "/" to carry out drawing.<br>Selecting "OFF" also draws a block with a slash "/".<br>The menu [Opt skip] works commonly between part systems. When this menu is set to ON (highlighted) in the 1st part system, it stays ON status even after the part system is switched, and when [Check continu] or [Check step] is performed, draw skipping the block with a slash "/". |
| Rotate        | This rotates the displayed workpiece shape.                                                                                                                                                                                                                                                                                                                                                                                                                                                                   |
| Scale display | This displays the scale of coordinate system direction and display range in the graphic drawing area.                                                                                                                                                                                                                                                                                                                                                                                                         |
| M0/M1 neglect | [Check method I]<br>If [M0/M1 neglect] is ON, the program check does not stop even when M00/M01 is commanded.<br>If [M0/M1 neglect] is OFF, the program check stops when M00/M01 is commanded.<br>[Check method II]<br>The menu [M0/M1 neglect] is grayed out and non-selectable.<br>The program check does not stop in the block where M00/M01 is commanded. (*1)                                                                                                                                            |
| Dsp Section   | This displays the cross section of workpiece shape.                                                                                                                                                                                                                                                                                                                                                                                                                                                           |
| Type change   | This switches between check method I and check method II.<br>When check method switch is invalid (parameter "#1231 set03/bit7" is set to "1"), this menu is not displayed.                                                                                                                                                                                                                                                                                                                                    |
| Work setting  | This sets the workpiece shape used at the solid display.                                                                                                                                                                                                                                                                                                                                                                                                                                                      |

| Menus        | Details                                             |
|--------------|-----------------------------------------------------|
| Tool setting | This sets the tool shape used at the solid display. |

(\*1) M code independent output (DM00/DM01) follows the parameter setting indicated below.

- #1284 ext20/bit3 (M code output during multi-system simultaneous simulation (Check type II))
- #1405 M\_mode(SMLK) (M code output (during high-speed simple program check))
- #1451 M[M031-000](SMLK) to #1466 M[M511-480](SMLK) (Special operation registration M code (High-speed simple program check))

### Note

- (1) When automatic operation is running during the graphic trace mode, the menu [Check search], [Check continu], [Check step], [Check reset] cannot be selected and the 3D solid program check cannot be performed. If the program is not in the process of automatic operation, a check is possible only for 3D solid.
- (2) The menus [2D check], [Check search], [Work setting] and [Tool setting] cannot be selected while the check is performed or interrupted.
- (3) The menu [M0/M1 neglect] is grayed out during continuous check, and the menu cannot be selected.
- (4) The coordinate system direction and the scale display are held after the screen is switched, but they are not held after the power is turned OFF and ON again.

#### 4.3.1 Switching Check Method

Press the menu [Type change] to switch between check method I and check method II. Every time you press the menu, the type is switched between check method I and check method II.

The menu [Type change] is displayed when the check method switch is valid (parameter "#1231 set03/bit7" is set to "0").

You can confirm whether it is in check method I or II by the indication of "SelectSys" on the screen.

Check method I: "SelectSys" is not indicated.

Check method II: "SelectSys" is indicated.

## 4.3.2 Checking Continuously

There are three types of method for checking the program.

- Checking the specified program
- Checking the program currently opened on the edit screen (Edit)
- Checking the program searched on the monitor screen (Monitr)



**Operation method (Selecting a program to be checked)**
**Checking the specified program**

- (1) Press the  key to switch the part system.  
In addition to the above, the PLC signal and touch-screen operation are provided as the part system switching method.
- (2) Press the main menu [Check] on the edit screen.  
Press the menu [3D Check] when the program check (2D) appears.
- (3) Press the menu [Check search].  
If you press the menu [Commentnondisp] in the second page, the comment is hidden.

- (4) Select the device.  
(Example) Menu [Memory]



The selected device name and directory (memory: /program) appear in the device name and directory display columns.  
For the devices other than NC memory, root directory is selected.

- (5) (For the devices other than NC memory)  
Use the [↑], [↓], , or  key to align the cursor with a directory to be newly created.

Press the [INPUT] key to move to inside the directory.

- (6) Press the [↑], [↓],  or  key to move the cursor to the program to be searched.

The name of the machining program to be edited can be input in the input area.

When the touchscreen display unit is used, you can also select a program by touch operation.

<Note>

- If the list contents differ from the actual device or directory, press the menu [List Update].
- Press the menu [Sort change] to change the sort. Each time the menu key is pressed, the sort method shifts in the following order: file names in ascending order -> file names in descending order -> dates and comments in ascending order -> dates and comments in descending order -> file names in ascending order.

- (7) Press the [INPUT] key.  
When setting data exists in the input area, a search is performed in this data. This procedure is also used when performing an NB search.

(Example)

1001/1/2 O1001 N1 B2  
1001.PRG/1/2 O1001.PRG N1 B2  
/1/2 (current O number) N1 B2  
1001//2 O1001 N0 B2  
1001/1 O1001 N1 B0  
1001 O1001 N0 B0  
/1 (current O number) N1 B0  
//2 (current O number) N0



The check search is started.  
When the search is completed, the operation message "Search completed" is displayed.  
The searched device and program position appear in the display area for the machining program currently being executed.  
The list display is closed.  
The system distinguishes between presence and absence of an extension, and therefore due care should be taken.

### Note

- (1) The operation message "Sorting of tool data is in progress" is displayed when tool data is being sorted, and the check search is disabled.

### Checking the program currently opened on the edit screen

- (1) Press the  key to switch the part system.

In addition to the above, the PLC signal and touchscreen operation are provided as the part system switching method.

- (2) Press the menu [Program check] on the edit screen.  
Press the menu [3D Check] when the program check (2D) appears.

### Note

- (1) Regardless of the check method or the setting of the parameters "#8982 CheckSmltns\$1InvlD" to "#8989 CheckSmltns\$8InvlD", the program opened on the Edit screen is drawn as a machining program in single part system (displayed part system). Only the displayed part system is displayed in "Selected part system" on the screen.

### Checking the program searched on the monitor screen

- (1) Press the  key to switch the part system.

In addition to the above, the PLC signal and touchscreen operation are provided as the part system switching method.

- (2) Press the menu [Check] on the edit screen.  
Press the menu [3D Check] when the program check (2D) appears.

### Note

- (1) With check method II, among the part systems to be checked (parameters "#8982 CheckSmltns\$1InvlD" to "#8989 CheckSmltns\$8InvlD"), the part system being searched on the monitor screen is drawn.

**Operation method (Executing the program check)**

- (1) Press the menu [Check continu].



The program check is executed for one block, and work-piece shape in the cutting process is drawn.

Behaviors during check operation

- ◆ Press the menu [Check step], the program check is carried out block by block starting from the next block.
- ◆ Press the menu [Check continue], the program check is stopped. Press the menu [Check continu] during block stoppage, the program check is carried out continuously.
- ◆ Press the menu [Check reset], the program check is reset after completion of the currently executing block.

A "Checking" message appears and the menu [Check continu] is highlighted.

The check counter display is updated.

The check G modal is not displayed.

The machining time is updated.

With the check method I, the program check is performed for the displayed part system. Switch the part system to be displayed as required.

When the check is completed, a message appears and the mode returns to normal.

The menu highlight returns to normal.

**Note**

- (1) The operation message "Sorting of tool data is in progress" is displayed when tool data is being sorted, and the check is disabled.

## 4.3.3 Checking One Block at a Time

There are three types of method for checking the program.

- ◆ Checking the specified program
- ◆ Checking the program currently opened on the edit screen (Edit)
- ◆ Checking the program searched on the monitor screen (Monitr)

Perform the same procedure as "4.3.2 Checking Continuously" on selecting a program.

**Operation method (Executing the program check)**

- (1) Press the menu [Check step].



The program check is executed for one block, and work-piece shape in the cutting process is drawn.

The check counter display is updated.

The check G modal display is updated.

The machining time is updated.

- (2) Press the menu [Check step] again.



The program check is executed for the single block.

When the check is completed, a message appears and the mode returns to normal.

The menu highlight returns to normal.

Behaviors during check operation

- ◆ Press the menu [Check continue], program check is carried out continuously up to the end of the program.
- ◆ Press the menu [Check reset], the program check is reset.

**Note**

- (1) The operation message "Sorting of tool data is in progress" is displayed when tool data is being sorted, and the check search is disabled.

#### 4.3.4 Checking Multiple Part Systems Simultaneously

With Check method II, machining programs in multiple part systems can be drawn simultaneously. If you press the menu [Check continu] or [Check step], the movement path of the machining program in the part system being searched is drawn among the target part systems. Select the target part system with the parameters "#8982 CheckSmltns\$1Invlid" and "#8989 CheckSmltns\$8Invlid" (The part system in which the parameter is 1 is out of the target).

##### Operation method (Selecting a program to be checked)

- (1) Press the main menu [Check] on the edit screen.  
Press the menu [3D Check] when the program check (2D) appears.
- (2) Press the  key to switch to the part system to be checked.  
In addition to the above, the PLC signal and touch-screen operation are provided as the part system switching method.
- (3) Press the menu [Check search].  
For details on how to search the machining program, refer to "4.3.2 Checking Continuously".
- (4) Repeat (2) and (3) to check the machining program of the part system to be checked.

##### Note

- (1) When the multi-part system program management is valid (#1285 ext21/bit0 =1, ext21/bit1 =1), since the check search is executed across all part systems in batch only for the machining programs in NC memory, the step (4) is not necessary.

##### Operation method (Executing the program check)

- (1) Press the menu [Check continu] or [Check step].  
For details on how to execute the check, refer to "4.3.2 Checking Continuously" and "4.3.3 Checking One Block at a Time".
- 
- The program check is executed, and workpiece shape in the cutting process is drawn.

##### Note

- (1) If you press the menu [Check step], the check is executed (is drawn) on the program of displayed part system by one block. The process of the non-displayed part system moves ahead by the time of one block check for the displayed part system. Thus, the drawing of the non-displayed part system may be interrupted or may proceed for multiple blocks. The program check is not executed on the part system for which the parameter (any of #8982 to #8989) is set to "1" (check-invalid part system).  
When the displayed part system is set as a check-invalid part system, the check is executed on the part system whose No. is the smallest among the check-valid part systems by one block.

### 4.3.5 Canceling the Program Check

Cancel the program check under the execution of continuous check or step in the middle.

#### Operation method

- (1) Press the menu [Check reset].



The check mode is released, and the menu highlight returns to normal.  
The operation message "Reset complete" appears.

Even when the screen transits from the check screen during the program check, the program check is canceled.

With check method II and check method I (M80), the program check is canceled in the middle if the reset signal or the emergency stop signal outputs.

### 4.3.6 Enlarging and Reducing the Workpiece Shape

#### Operation method

- (1) Press the menu [Zoom].
- (2) Press the menu [Zoom in].  
To enlarge the figure:  
Press the menu [Zoom in] or [-] key.  
To reduce the figure:  
Press the menu [Zoom out] or [+] key.

### 4.3.7 Moving the Workpiece Shape

#### Operation method

- (1) Press the menu [Move].
- (2) Use the menu [Up], [Down], [Left], or [Right] to adjust the display position.  
The cursor movement keys ( [↑], [↓], [←], [→] ) can also be used for moving.

### 4.3.8 Rotating the Workpiece Shape

#### Operation method

- (1) Press the menu [Rotate].
- (2) Use the menu [Up], [Down], [Left], or [Right] to adjust the display angle.  
The cursor movement keys ( [↑], [↓], [←], [→] ) can also be used for moving.  
The display of drawing parts will be highlighted by selecting the menu [Rev Dsp].

#### Note

- (1) The set display angle is maintained even after rebooting the machine.
- (2) When all of storage data concerning the drawing such as display angle become zero by NC data reset, the scale setting is automatically performed (same state as when the menu [Auto scale] is pressed).



### 4.3.9 Performing an Interference Check

If the tool and workpiece contact each other when performing rapid traverse (G0) movement, the contact location is drawn in a color highlighting the interference.

It is possible to check whether the tool interferes with the workpiece during G0 movement before and after cutting. The drawing does not stop even when interference occurs.

Because the shank part is fixedly drawn in a liner form, the shank part may interfere with a workpiece during inner diameter machining. Therefore, the tool nose part is the target of interference check but the shank part is not the target. (The part of workpiece where the shank interferes is not shaved.)

With the check method II, the interference is checked in all the part system to be checked. The interference between tools is not checked.

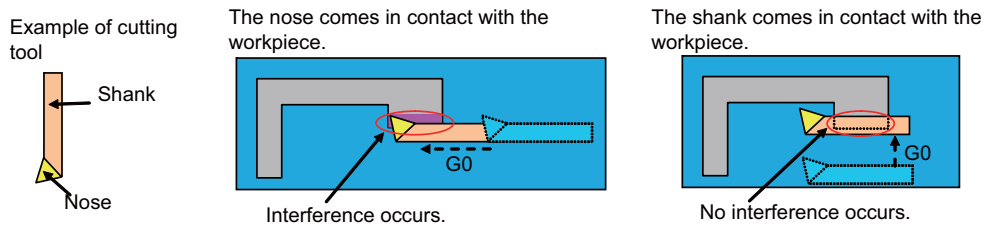

#### Operation method

- (1) Press the menu [Colli check].
- (2) Press the menu [Check step] or [Check continu]. ➔ The program check is executed for one block, and workpiece shape in the cutting process is drawn. A "Checking" message is displayed and the menu [Check step] or [Check continu] is highlighted. The workpiece and tool contact, this is drawn in a color highlighting the interference.

### 4.3.10 Setting the Workpiece Shape

Press the menu [Work setting] to display a pop-up window similar to the following, and set the workpiece shape used in the solid display.

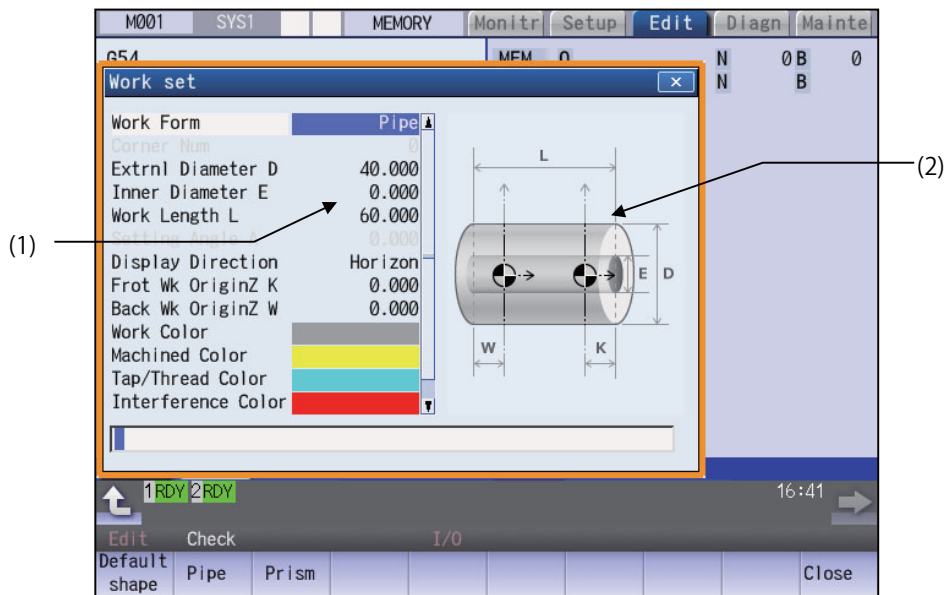

#### Display items

| Display items                       | Description                                                                                                                                 |
|-------------------------------------|---------------------------------------------------------------------------------------------------------------------------------------------|
| (1) Workpiece shape setting area    | This sets all workpiece shape items.                                                                                                        |
| (2) Workpiece setting guide drawing | This displays a material shape guide drawing. The displayed guide drawing is changed according to the coordinates set on "Work set" screen. |

#### Menus (the cursor is at "Work Form" (material shape))

| Menus         | Description                                                                                                                                                     |
|---------------|-----------------------------------------------------------------------------------------------------------------------------------------------------------------|
| Default shape | This sets the material shape. If a default shape is selected, it is drawn as a round bar. Designate "Pipe" for a round bar. Designate "Prism" for a square bar. |
| Pipe          |                                                                                                                                                                 |
| Prism         |                                                                                                                                                                 |
| Close         | This closes the pop-up window and quits this function.                                                                                                          |

#### Menus (the cursor is at the viewing direction)

| Menus | Description                                             |
|-------|---------------------------------------------------------|
| Horiz | This designates the viewing direction of the workpiece. |
| Verti |                                                         |

**Menus (the cursor is at the "Work Color", "Machined Color", "Tapped Color", "Interference Color", or "Section Color")**

| Menus         | Details                                                                                                                                                                                                                                                                                                                                                                                          |
|---------------|--------------------------------------------------------------------------------------------------------------------------------------------------------------------------------------------------------------------------------------------------------------------------------------------------------------------------------------------------------------------------------------------------|
| Default color | This sets the material color (Work Color), machining surface color (Machined Color), tapped/threaded surface color (Tapped/Threaded color), interference surface color (Interference Color) and section color (Section Color).                                                                                                                                                                   |
| Gray          | The drawings are made using the following colors when the default colors are selected.<br>Material color: Gray                                                                                                                                                                                                                                                                                   |
| Red           | Machining surface color: Yellow<br>Tap machining surface color: Light blue<br>Interference surface color: Red                                                                                                                                                                                                                                                                                    |
| Close         | Cross section color: Green<br><Note>                                                                                                                                                                                                                                                                                                                                                             |
| Blue          | ♦The "Tapped Color", that is the same as when the tapping tool is selected, is used on the "Work set" screen. Therefore, switching of the tap surface color and normal surface color depends on not G command but the selected tool. However, even with the tapping tool being selected, if it is moved in the arc or helical direction, the "Work Set" screen does not have the "Tapped Color". |
| Green         |                                                                                                                                                                                                                                                                                                                                                                                                  |
| Light blue    |                                                                                                                                                                                                                                                                                                                                                                                                  |
| Purple        |                                                                                                                                                                                                                                                                                                                                                                                                  |
| Pink          |                                                                                                                                                                                                                                                                                                                                                                                                  |
| Close         | This closes the pop-up window and quits this function.                                                                                                                                                                                                                                                                                                                                           |

**Menu (the cursor is at other item)**

| Menus | Details                                                |
|-------|--------------------------------------------------------|
| Close | This closes the pop-up window and quits this function. |

**Setting the material shape (Work Form)**

- (1) Use the [↑] or [↓] key to move the cursor to the material shape settings column.
  - (2) Press the menu [Pipe].  
It is also possible to set input values.  
0 [INPUT]: Default shape  
1 [INPUT]: Pipe  
2 [INPUT]: Prism
- ➔ "Pipe" appears at the cursor position.  
The cursor moves to the next line.  
A pipe guide drawing appears in the guide drawing area.

**Setting the workpiece zero point Z**

For the workpiece zero point, set the margin from the face of the material. For the margin, set the distance in the Z axis direction between the face and the workpiece zero point.

- (1) Use the [↑] or [↓] key to move the cursor to the setting column of the front-side workpiece zero point Z.
  - (2) Input data.  
(Example) 10 [INPUT]
  - (3) Set the back-side workpiece zero point Z in the same manner.  
If there is no back-side spindle, it is not necessary to set the back-side workpiece zero point Z.
- ➔ "10.000" appears at the cursor position.  
The cursor moves to the next line.

**Note**

- (1) The following table shows the setting range of the workpiece zero point.
- (2) If a value outside of the setting range is entered, an error occurs, and the value cannot be set.

| #1003 Input setup unit | #1041 I_inch                  |                               |
|------------------------|-------------------------------|-------------------------------|
|                        | 0 (mm)                        | 1 (inch)                      |
| B                      | -99999.999 to 99999.999       | -9999.9999 to 9999.9999       |
| C                      | -99999.9999 to 99999.9999     | -9999.99999 to 9999.99999     |
| D                      | -99999.99999 to 99999.99999   | -9999.999999 to 9999.999999   |
| E                      | -99999.999999 to 99999.999999 | -9999.9999999 to 9999.9999999 |

- (3) With the check method II, as the drawing is performed with the machine zero point as zero point, the values of this setting item are not used.

**Setting the material outer diameter**

Set the outer diameter of the material in millimeters in the millimeter system, and in inches in the inch system.

- (1) Use the [↑] or [↓] key to move the cursor to the setting column of material outer diameter.
- (2) Input data. (Example) 100 [INPUT]  "100.000" appears at the cursor position. The cursor moves to the next line.
- (3) Set other dimensional data items in the same manner.

**Note**

- (1) The following table shows the setting ranges of the outer diameter of the material and other dimensional data items.
- (2) If a value outside of the setting range is entered, an error occurs, and the value cannot be set.

| #1003 Input setup unit | #1041 I_inch             |                           |
|------------------------|--------------------------|---------------------------|
|                        | 0 (mm)                   | 1 (inch)                  |
| B                      | 0.001 to 99999.999       | 0.0001 to 9999.9999       |
| C                      | 0.0001 to 99999.9999     | 0.00001 to 9999.99999     |
| D                      | 0.00001 to 99999.99999   | 0.000001 to 9999.999999   |
| E                      | 0.000001 to 99999.999999 | 0.0000001 to 9999.9999999 |

**Setting the material color (WorkColor)**

- (1) Use the [↑] or [↓] key to move the cursor to the material color setting column.
- (2) Press the material color menu. (Example) [Gray]  The cell where the cursor is located appears in gray. The cursor moves to the next line. (The cursor does not move when at the cross section color.)  
 It is also possible to set input values.  
 0 [INPUT]: Default color  
 1 [INPUT]: Gray  
 2 [INPUT]: Red  
 3 [INPUT]: Yellow  
 4 [INPUT]: Blue  
 5 [INPUT]: Green  
 6 [INPUT]: Light blue  
 7 [INPUT]: Purple  
 8 [INPUT]: Pink
- (3) Set the other color data in the same way.  
 <Note>  
 ♦The following colors are used if the default colors are designated.  
 Material color: Gray  
 Machining surface color: Yellow  
 Tap machining surface color/screw machining surface color: Light blue  
 Interference surface color: Red  
 Cross section color: Green

4.3.11 Setting the Tool Shape

Press the menu [Tool setting] to display the tool management screen. Set the tool shape used in the solid display for graphic check on the tool management screen.

Even though the menu [T-Mng.] is pressed on the [Setup] screen, the same screen can be displayed. For details, refer to "6.5 Setting the Tool Management Data (Tool Management Screen)".

4.3.12 Checking a Machining Program between Part Systems

When checking multi-part system programs with the check method I, check a program of one part system first, and then switch the part system to check the other program. Multiple programs cannot be checked at a time with the check method I.

It depends on the part system as to whether a workpiece is mounted to the front side or rear side spindle when the check starts, as shown in the figure below.

When the rear side spindle exists (the parameter "#12628 sub sp no" is set to nonzero), and you switch the part system to 2nd or 4th, the workpiece is assumed to be mounted to the rear side spindle. When the rear side spindle exists, and switch the part system to other than 2nd and 4th, the workpiece is assumed to be mounted to front side spindle.

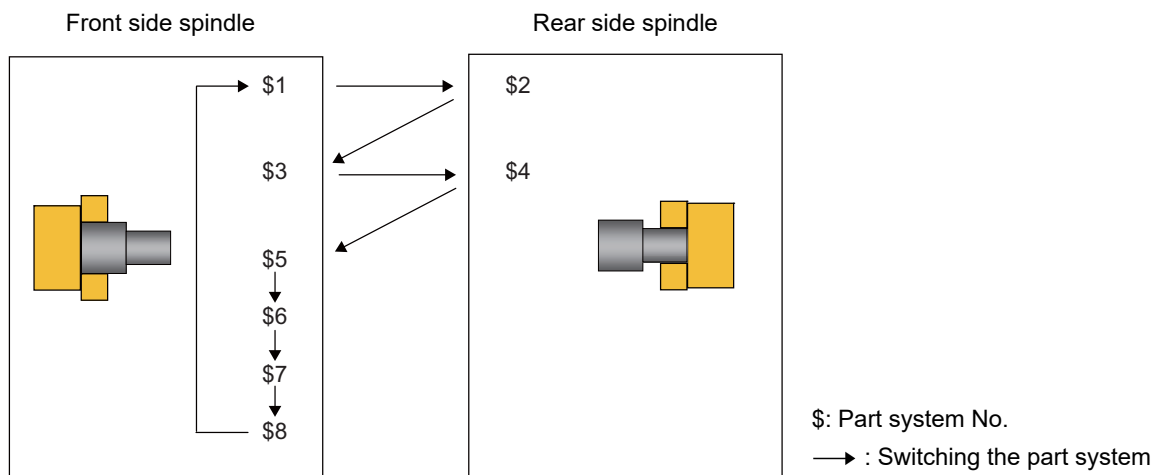

When the rear side spindle exists, and operation is started with the 2nd or 4th part system, the workpiece is assumed to be mounted to the rear side spindle.

When the rear side spindle exists, and operation is started with a part system other than 2nd and 4th, the workpiece is assumed to be mounted to the front side spindle.

When the rear side spindle does not exist, the workpiece is assumed to be mounted to the front side spindle.

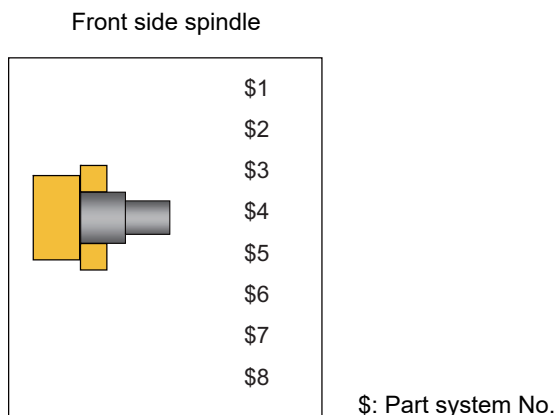

When the spindle is switched between the front and rear sides, the workpiece zero point position Z will also be switched. Thus, the workpiece on the screen is not changed, but the coordinate of the tool will be displayed based on the workpiece zero point position Z of the spindle side.

If it is necessary to change the zero point position Z of the front or rear workpiece after switching the part system, change it on the "Work set" screen. When the parameter "#1231 set03/bit6" (Initialization of drawing in graphic check) is valid, the workpiece shape is retained if you change the setting values.

The setting items for a workpiece shape are common to all part systems. Thus when the part system is switched, the settings do not change. When executing the multi-part system program, and if you change any setting including the workpiece zero point position after switching between the front and rear side spindles, the workpiece is initialized. Therefore, when the parameter "#1231 set03/bit6" (Initialization of drawing in graphic check) is valid, the workpiece will not be initialized even if specific setting item for the workpiece shape is changed.

Refer to the following table to see whether the workpiece is initialized or not by changing each item for workpiece shape.

| No. | Setting item for workpiece shape      | Parameter "#1231 set03/bit6" |          |
|-----|---------------------------------------|------------------------------|----------|
|     |                                       | Enabled                      | Disabled |
| 1   | Work form                             | x                            | x        |
| 2   | Number of corner                      | x                            | x        |
| 3   | Workpiece outer diameter              | x                            | x        |
| 4   | Workpiece inner diameter              | x                            | x        |
| 5   | Workpiece length                      | x                            | x        |
| 6   | Setting angle                         | x                            | x        |
| 7   | Display direction                     | o                            | x        |
| 8   | Front workpiece zero point position Z | o                            | x        |
| 9   | Rear workpiece zero point position Z  | o                            | x        |
| 10  | Workpiece color                       | o                            | x        |
| 11  | Machined color                        | o                            | x        |
| 12  | Tapped/Threaded color                 | o                            | x        |
| 13  | Interference Color                    | o                            | x        |
| 14  | Section Color                         | o                            | x        |

x: Initialized      o: Not initialized

#### 4.3.13 Setting the Drawing Speed of Program Check

Refer to "4.2.12 Setting the Drawing Speed of Program Check".

## 4.3.14 Availability of Check Mode with Other Functions

Refer to "4.2.14 Availability of Check Mode with Other Functions".

However, in the program check (3D) for L system, the relationship between the workpiece coordinate system offset and program format switch is as follows.

| Function name                      | Remarks                                                                                                                                                                                                                                                                                                                                                                                                                                                                                                                                                                                                                                                                                                                                                                                                                                                                                                                                                                                                                                                                                                                                                                                                                                                                                                                                                                                                                                                                                                                                                                 |        |          |           |                           |             |                                        |             |                           |             |                             |       |                        |       |                                                                               |     |                       |        |          |      |                           |        |          |     |                                             |         |                          |
|------------------------------------|-------------------------------------------------------------------------------------------------------------------------------------------------------------------------------------------------------------------------------------------------------------------------------------------------------------------------------------------------------------------------------------------------------------------------------------------------------------------------------------------------------------------------------------------------------------------------------------------------------------------------------------------------------------------------------------------------------------------------------------------------------------------------------------------------------------------------------------------------------------------------------------------------------------------------------------------------------------------------------------------------------------------------------------------------------------------------------------------------------------------------------------------------------------------------------------------------------------------------------------------------------------------------------------------------------------------------------------------------------------------------------------------------------------------------------------------------------------------------------------------------------------------------------------------------------------------------|--------|----------|-----------|---------------------------|-------------|----------------------------------------|-------------|---------------------------|-------------|-----------------------------|-------|------------------------|-------|-------------------------------------------------------------------------------|-----|-----------------------|--------|----------|------|---------------------------|--------|----------|-----|---------------------------------------------|---------|--------------------------|
| Workpiece coordinate system offset | <p>[Check method I]</p> <p>The offset is disabled. A drawing is performed with the following position as zero point.</p> <ul style="list-style-type: none"> <li>♦X-axis zero point: Center of workpiece</li> <li>♦Z-axis zero point: Front-side workpiece zero point Z, rear-side workpiece zero point (set on the workpiece setting screen)</li> <li>♦Y-axis zero point: Center of workpiece</li> <li>♦Rotary axis zero point: 0 °</li> </ul> <p>[Check method II]</p> <p>The offset is enabled.</p>                                                                                                                                                                                                                                                                                                                                                                                                                                                                                                                                                                                                                                                                                                                                                                                                                                                                                                                                                                                                                                                                   |        |          |           |                           |             |                                        |             |                           |             |                             |       |                        |       |                                                                               |     |                       |        |          |      |                           |        |          |     |                                             |         |                          |
| Program format switch              | <p>If M system G code shown below is commanded during program format switch, the machining result is different from the actual machining.</p> <p>M system G code for which the machining result is different from the actual machining with check method I/II</p> <table border="1"> <thead> <tr> <th>G code</th> <th>Function</th> </tr> </thead> <tbody> <tr> <td>G2.3/G3.3</td> <td>Exponential interpolation</td> </tr> <tr> <td>G41.2/G42.2</td> <td>3-dimensional tool radius compensation</td> </tr> <tr> <td>G43.4/G43.5</td> <td>Tool center point control</td> </tr> <tr> <td>G53.1/G53.6</td> <td>Tool axis direction control</td> </tr> <tr> <td>G61.4</td> <td>Spline interpolation 2</td> </tr> <tr> <td>G68.3</td> <td>Inclined surface machining command (Designation with the tool axis direction)</td> </tr> <tr> <td>G84</td> <td>Fixed cycle (tapping)</td> </tr> </tbody> </table> <p>M system G code for which the machining result is different from the actual machining with check method II</p> <table border="1"> <thead> <tr> <th>G code</th> <th>Function</th> </tr> </thead> <tbody> <tr> <td>G7.1</td> <td>Cylindrical interpolation</td> </tr> </tbody> </table> <p>M system G code for which the machining result is different from the actual machining with check method I</p> <table border="1"> <thead> <tr> <th>G code</th> <th>Function</th> </tr> </thead> <tbody> <tr> <td>G38</td> <td>Tool radius compensation vector designation</td> </tr> <tr> <td>G41/G42</td> <td>Tool radius compensation</td> </tr> </tbody> </table> | G code | Function | G2.3/G3.3 | Exponential interpolation | G41.2/G42.2 | 3-dimensional tool radius compensation | G43.4/G43.5 | Tool center point control | G53.1/G53.6 | Tool axis direction control | G61.4 | Spline interpolation 2 | G68.3 | Inclined surface machining command (Designation with the tool axis direction) | G84 | Fixed cycle (tapping) | G code | Function | G7.1 | Cylindrical interpolation | G code | Function | G38 | Tool radius compensation vector designation | G41/G42 | Tool radius compensation |
| G code                             | Function                                                                                                                                                                                                                                                                                                                                                                                                                                                                                                                                                                                                                                                                                                                                                                                                                                                                                                                                                                                                                                                                                                                                                                                                                                                                                                                                                                                                                                                                                                                                                                |        |          |           |                           |             |                                        |             |                           |             |                             |       |                        |       |                                                                               |     |                       |        |          |      |                           |        |          |     |                                             |         |                          |
| G2.3/G3.3                          | Exponential interpolation                                                                                                                                                                                                                                                                                                                                                                                                                                                                                                                                                                                                                                                                                                                                                                                                                                                                                                                                                                                                                                                                                                                                                                                                                                                                                                                                                                                                                                                                                                                                               |        |          |           |                           |             |                                        |             |                           |             |                             |       |                        |       |                                                                               |     |                       |        |          |      |                           |        |          |     |                                             |         |                          |
| G41.2/G42.2                        | 3-dimensional tool radius compensation                                                                                                                                                                                                                                                                                                                                                                                                                                                                                                                                                                                                                                                                                                                                                                                                                                                                                                                                                                                                                                                                                                                                                                                                                                                                                                                                                                                                                                                                                                                                  |        |          |           |                           |             |                                        |             |                           |             |                             |       |                        |       |                                                                               |     |                       |        |          |      |                           |        |          |     |                                             |         |                          |
| G43.4/G43.5                        | Tool center point control                                                                                                                                                                                                                                                                                                                                                                                                                                                                                                                                                                                                                                                                                                                                                                                                                                                                                                                                                                                                                                                                                                                                                                                                                                                                                                                                                                                                                                                                                                                                               |        |          |           |                           |             |                                        |             |                           |             |                             |       |                        |       |                                                                               |     |                       |        |          |      |                           |        |          |     |                                             |         |                          |
| G53.1/G53.6                        | Tool axis direction control                                                                                                                                                                                                                                                                                                                                                                                                                                                                                                                                                                                                                                                                                                                                                                                                                                                                                                                                                                                                                                                                                                                                                                                                                                                                                                                                                                                                                                                                                                                                             |        |          |           |                           |             |                                        |             |                           |             |                             |       |                        |       |                                                                               |     |                       |        |          |      |                           |        |          |     |                                             |         |                          |
| G61.4                              | Spline interpolation 2                                                                                                                                                                                                                                                                                                                                                                                                                                                                                                                                                                                                                                                                                                                                                                                                                                                                                                                                                                                                                                                                                                                                                                                                                                                                                                                                                                                                                                                                                                                                                  |        |          |           |                           |             |                                        |             |                           |             |                             |       |                        |       |                                                                               |     |                       |        |          |      |                           |        |          |     |                                             |         |                          |
| G68.3                              | Inclined surface machining command (Designation with the tool axis direction)                                                                                                                                                                                                                                                                                                                                                                                                                                                                                                                                                                                                                                                                                                                                                                                                                                                                                                                                                                                                                                                                                                                                                                                                                                                                                                                                                                                                                                                                                           |        |          |           |                           |             |                                        |             |                           |             |                             |       |                        |       |                                                                               |     |                       |        |          |      |                           |        |          |     |                                             |         |                          |
| G84                                | Fixed cycle (tapping)                                                                                                                                                                                                                                                                                                                                                                                                                                                                                                                                                                                                                                                                                                                                                                                                                                                                                                                                                                                                                                                                                                                                                                                                                                                                                                                                                                                                                                                                                                                                                   |        |          |           |                           |             |                                        |             |                           |             |                             |       |                        |       |                                                                               |     |                       |        |          |      |                           |        |          |     |                                             |         |                          |
| G code                             | Function                                                                                                                                                                                                                                                                                                                                                                                                                                                                                                                                                                                                                                                                                                                                                                                                                                                                                                                                                                                                                                                                                                                                                                                                                                                                                                                                                                                                                                                                                                                                                                |        |          |           |                           |             |                                        |             |                           |             |                             |       |                        |       |                                                                               |     |                       |        |          |      |                           |        |          |     |                                             |         |                          |
| G7.1                               | Cylindrical interpolation                                                                                                                                                                                                                                                                                                                                                                                                                                                                                                                                                                                                                                                                                                                                                                                                                                                                                                                                                                                                                                                                                                                                                                                                                                                                                                                                                                                                                                                                                                                                               |        |          |           |                           |             |                                        |             |                           |             |                             |       |                        |       |                                                                               |     |                       |        |          |      |                           |        |          |     |                                             |         |                          |
| G code                             | Function                                                                                                                                                                                                                                                                                                                                                                                                                                                                                                                                                                                                                                                                                                                                                                                                                                                                                                                                                                                                                                                                                                                                                                                                                                                                                                                                                                                                                                                                                                                                                                |        |          |           |                           |             |                                        |             |                           |             |                             |       |                        |       |                                                                               |     |                       |        |          |      |                           |        |          |     |                                             |         |                          |
| G38                                | Tool radius compensation vector designation                                                                                                                                                                                                                                                                                                                                                                                                                                                                                                                                                                                                                                                                                                                                                                                                                                                                                                                                                                                                                                                                                                                                                                                                                                                                                                                                                                                                                                                                                                                             |        |          |           |                           |             |                                        |             |                           |             |                             |       |                        |       |                                                                               |     |                       |        |          |      |                           |        |          |     |                                             |         |                          |
| G41/G42                            | Tool radius compensation                                                                                                                                                                                                                                                                                                                                                                                                                                                                                                                                                                                                                                                                                                                                                                                                                                                                                                                                                                                                                                                                                                                                                                                                                                                                                                                                                                                                                                                                                                                                                |        |          |           |                           |             |                                        |             |                           |             |                             |       |                        |       |                                                                               |     |                       |        |          |      |                           |        |          |     |                                             |         |                          |



**Note**

## (1) Reference position return and start position return

The reference position return command and start position return command are valid, but actual machine motion (trace display) is partially different from the drawing by program check.

With check method I, as shown in the figure below, when returning to the reference position via the intermediate point with the G28 or G30 command, positioning to the intermediate point is done by a straight line and positioning from there to the reference position is done by each axis independently.

With the G29 command, positioning to the intermediate point is done by each axis independently.

Under program checking, however, positioning is always done by a straight line even when returning via the intermediate point. This may cause a little difference from the trace display.

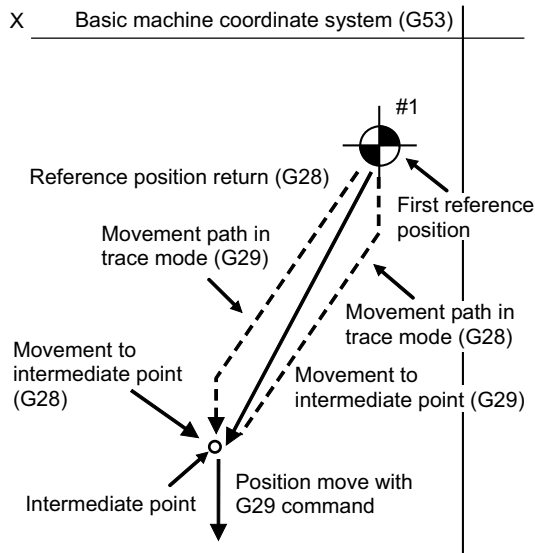

#### 4.3.15 Handling of Variable Commands, Programmable Parameter Input, and Programmable Compensation Data Input

Refer to "4.2.15 Handling of Variable Commands, Programmable Parameter Input, and Programmable Compensation Data Input".

#### 4.3.16 Notes for Graphic Check (3D)

- (1) The check function is valid for only NC internal operation results. Thus, the path is not drawn for the command which requires machine movement.
- (2) For the handling of various types of data being set in the program, refer to "4.2.15 Handling of Variable Commands, Programmable Parameter Input, and Programmable Compensation Data Input".
- (3) "Program check completed" appears with M02/M30 command.
- (4) Graphic check is not available for serial and MDI program.
- (5) Operation search is not available for the program whose file name is consist of 33 characters or more.
- (6) When the check is executed, the drawing starts from the machine coordinate zero point. However, the machine coordinate zero point is (0, 0, 0) even when the value is set to the parameter "#2037 G53ofs" (zero point return).
- (7) The drawing coordinate system settings of 2D and 3D graphic check are not linked.
- (8) The origin mark is not drawn on the 3D drawing parts.
- (9) If the screen is switched during checking, the check reset occurs and the check is interrupted.
- (10) If tracing is turned ON during automatic operation, the menus such as [Check Search], [Check Continue], [Check Step], and [Check Reset] are grayed out. You cannot perform 3D solid check.
- (11) The drawing is not initialized even if the performance such as enlarge, reduce, move, change display mode, or rotate is set during check drawing. The program does not stop, either.
- (12) With the check method I, if the part system is switched during checking, the check is reset. With the check method II, the check is not reset.
- (13) Tool shape is drawn using the value (shape data A to H) set in the tool management screen, regardless of the value of the parameter "#8920 3D tool ofs select".

4 Checking a Machining Program on Screen

- (14) When the tool change is specified and if the following data of the tool corresponding to the T number is zero, the tool is drawn as the default tool.

| Data               | Value                                                               |
|--------------------|---------------------------------------------------------------------|
| Tool type          | Lathe turning                                                       |
| Hand               | Front/Right hand: except 2nd/4th part system                        |
|                    | Back/Right hand: 2nd/4th part system (setting of #1268 is nonzero.) |
|                    | Front/Right hand: 2nd/4th part system (setting of #1268 is "0".)    |
| Tool length A      | 150mm                                                               |
| Tool length B      | 25mm                                                                |
| Nose angle         | 80°                                                                 |
| Cutting edge angle | 95°                                                                 |
| Nose R             | 1mm                                                                 |
| GangTool ofs Y     | 0mm                                                                 |

The tool to be displayed is switched to the tool corresponding to the T number when the tool exchange command is issued.

The previous tool is maintained and displayed until the next tool exchange command is issued.

It is not maintained when the power is turned on again. The default tool is displayed.

- (15) When the tool change is specified and if the following data of the tool corresponding to the T number is zero, the tool is drawn as the default tool.

Turning tool

| Turning            |       | Groove               |       | Thread cutting    |       | Turning drill     |       | Turning tapping   |        |
|--------------------|-------|----------------------|-------|-------------------|-------|-------------------|-------|-------------------|--------|
| Tool length A      | 150mm | Tool length A        | 150mm | Tool length A     | 150mm | Tool length A     | 150mm | Tool length A     | 150mm  |
| Tool length B      | 25mm  | Tool length B        | 25mm  | Tool length B     | 25mm  | Tool length B     | 25mm  | Tool length B     | 25mm   |
| Nose angle         | 80°   | Nose R               | 1mm   | Tool width        | 10mm  | Nose angle        | 118°  | Pitch             | 5mm    |
| Cutting edge angle | 95°   | Nose width           | 3mm   | GangTool ofs Y    | 0mm   | GangTool ofs Y    | 0mm   | Root dia.         | 1.25mm |
| Nose R             | 1mm   | Maximum groove depth | 12mm  | Color designation | Red   | Color designation | Red   | GangTool ofs Y    | 0mm    |
| GangTool ofs Y     | 0mm   | Tool width           | 10mm  |                   |       |                   |       | Color designation | Red    |
| Color designation  | Red   | GangTool ofs Y       | 0mm   |                   |       |                   |       |                   |        |
|                    |       | Color designation    | Red   |                   |       |                   |       |                   |        |

Milling tool

- If the tool length is 0: 150-mm tool length
- If tool radius is 0: 20-mm tool radius
- If shape data 1 is 0: 1-mm shape data 1 (it is 5 mm for the tap of tool type)
- If shape data 2 is 0: 1-mm shape data 2 (Tool diameter x 0.05 mm for the tap of tool type)
- Gang tool offset Y is 0 mm.
- If the color is not designated: Red tool

- (16) If the parameter "#8920 3D tool ofs select" is set to "0" or "1" and if the tool radius to be displayed is 0 or less, the 20-mm default tool radius is assumed and drawn.
- (17) If the fine segment program or complex shape program is executed for 3D checking, the "Solid check disabled (memory shortage)" message is displayed and the drawing may be erased. In such case, divide the program into subprograms and repeat check drawing. Before starting check drawing, press the menu [Initialize Workpiece] once.
- (18) With the check method I, the workpiece zero point is not changed even when a coordinate system switching command is included in the program that executes the program check. Therefore, the drawings may be overlapped and displayed.
- (19) The "Tapped Color", that is the same as when the tapping tool is selected, is used on the "Work set" screen. Therefore, switching of the tap surface color and normal surface color depends on not G command but the selected tool. However, even with the tapping tool being selected, if it is moved in the arc or helical direction, the "Work Set" screen does not have the "Tapped Color".
- (20) During 3D check, the tap is drawn as a straight rod and the shape data is not reflected (refer to "4.3.11 Setting the Tool Shape").

- (21) The check search cannot be executed when the sub part system that cannot be operated is displayed. If the search is carried out, the message "Search error" appears.
- (22) If there is a phase difference between the front and rear side spindles when passing a workpiece, the graphic may not be drawn correctly.
- (23) When the simple inclined surface machining is executed with the check method I, the counter on the check screen is displayed with the feature coordinate system.
- (24) For the rotation of tool rotary axis, the rotation method differs depending on the check method, I or II (see the figure below).

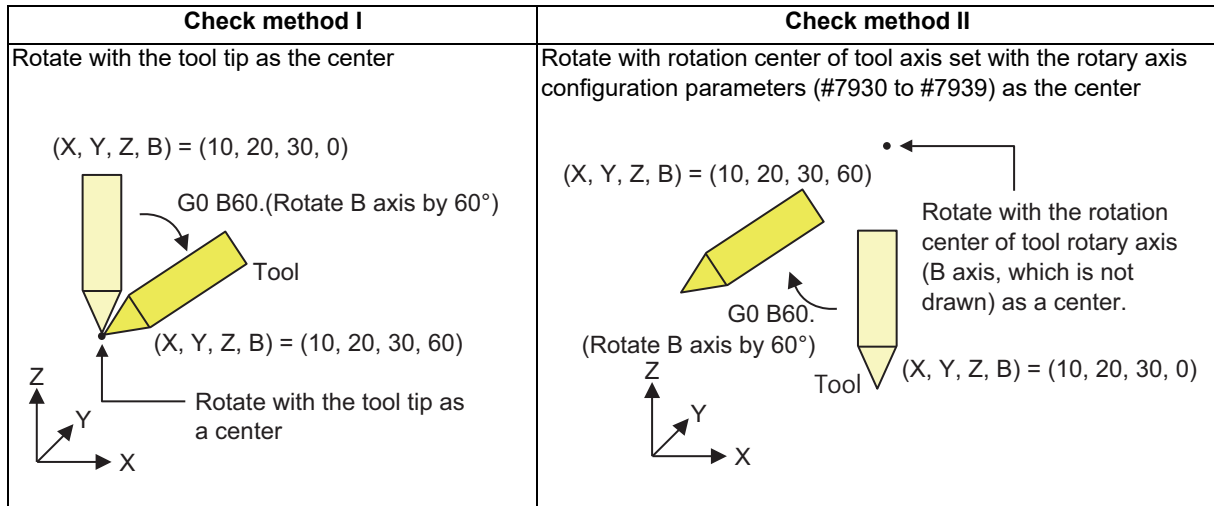

- (25) If such circular interpolation is executed that causes the angle between the start point and the end point to be 180 degrees or more during turning interpolation, the message "Draw library inside error(4)" appears. The tool moves to the end point of the circular interpolation; however, the workpiece is not machined.
- (26) If a travel command is executed during polar coordinate interpolation or cylindrical interpolation on the machine which cannot perform C axis control on its workpiece spindle, the message "Draw library inside error(4)" appears and the tool does not move.
- (27) If polar coordinate interpolation or circular interpolation is executed on the machine equipped with Y axis while Y axis is not at 0, the path is drawn differently from the actual machining.
- (28) If polar coordinate interpolation or circular interpolation is executed while the axis for which [GangTool ofs Y] is set to nonzero is in use, the path is drawn differently from the actual machining.
- (29) When the workpiece shape is changed from the external source such as another application, the drawing reflect to the workpiece shape on the 3D check screen by pressing the [Work setting] menu to display workpiece shape setting screen.

**Notes for check method I (background)**

- (1) If you press the cycle start button when an arbitrary part system is being checked, the operation alarm "M01 program check mode" is generated and the cycle start is disabled while the button is held down.  
Press the auto start button after the check is completed or after the check is stopped with the menu [Check reset].
- (2) If you carry out the operation search or check operation (continuous or step check) during cycle start or automatic stop of an arbitrary part system, an operation message "Executing automatic operation" is displayed, and no search or check drawing is carried out.
- (3) "Program check completed" appears with M02/M30 command. For the tape mode, the rewind process is not carried out.
- (4) The check ends with the reset (NC reset or the menu [Check reset]).  
When a program error occurs, cancel the error with the operation indicated above.  
If NC reset is selected when the check screen is being displayed, check drawing ends but the menu to switch to the 2D Check or 3D Check is kept invalid. To enable this switching, press the menu [Check reset].
- (5) During automatic operation, the contents of automatic operation program are displayed by the "Currently executed machining program" (ONB display) and "Buffer display" on the check screen. During checking, the contents of the checking program are displayed by the "Currently executed machining program" (ONB display) and "Buffer display" on the monitor screen.
- (6) If you carry out the operation search or check operation (continuous or step check) when the program is restarted, the "Program restarting" operation message is displayed, and no search or check drawing is carried out.
- (7) If the manual operation mode is selected during checking, the "M01 program check mode" is displayed and the axis cannot be moved. If you need to move the axis, temporarily stop the current check by executing a reset and then move the axis. When you switch from the manual operation mode to the memory mode, the alarm is released. You can continue the current check even if an alarm is output.
- (8) When the PLC Interrupt signal is turned ON during checking, the "M01 Program check mode" is selected. To start the PLC interrupt, terminate the current check by executing a reset. When you turn the PLC interrupt signal OFF, the alarm is released. You can continue the current checking even if the PLC Interrupt signal is ON.
- (9) When the M01 is commanded with the menu [M0/M1 neglect] disabled, the drawing stops regardless of the state (ON or OFF) of the optional stop switch.

**Notes for check method I (foreground)**

- (1) The program that you have selected during Check Search is not the program that is executed during automatic operation. Search the program for automatic operation by using the operation search function of the monitor screen.
- (2) The parameters and compensation amount do not reflect on check drawing even if you set them during checking. To reflect them on the drawings, reset the check once. Then, press the menu [Check continu] or [Check step] and execute the check again.
- (3) "Program check completed" appears with M02/M30 command.
- (4) The check is not terminated via execution of a reset.  
If a program error occurs, release the error by selecting the menu [Check reset].
- (5) During check search, if the length of the full path name exceeds 48 characters, you cannot move to another directory.
- (6) If the menu [Optional Skip] is ON (highlighted), the blocks that have the "/" character are skipped and the T-code list is obtained.
- (7) The file name continues to be displayed as an O-number display even if you erase or rename the file after it is checked and searched. If you check a file in this status, the "Push [Check reset] menu" message is displayed.
- (8) During checking, if you read the integrated time by using variable number #3001 or #3002, the checking start time is obtained. You cannot write the integrated time.
- (9) When [Check continu] is executed, even if variable number #3006 is used for checking, you cannot stop the program and you cannot display the message.
- (10) When the M01 is commanded with the menu [M0/M1 neglect] disabled, the drawing stops regardless of the state (ON or OFF) of the optional stop switch.

**Full-screen display of graphic check function (3D)**

- (1) For 3D check, the drawn workpiece shape is enlarged or reduced to be 90% of drawing area in accordance with the size of graphic drawing area when the screen is switched between normal display and full-screen display.

**Setting for base axes**

When a rotary axis is included among the base axis parameters I, J, and K (#1026 to #1028), set the base axis parameters for graphics I, J, and K (#8631 to #8633) to exclude the rotary axis as the following example.

If all the base axis parameters for graphics I, J, and K are not set, the graphic check operates in accordance with the setting of the base axis parameters #1026 to #1028.

[Setting example of parameters]

Base axis parameter

| No.   | Parameter name | Setting value | Explanation |
|-------|----------------|---------------|-------------|
| #1026 | base_I         | X             | Liner axis  |
| #1027 | base_J         | C             | Rotary axis |
| #1028 | base_K         | Z             | Liner axis  |

Base axis parameter for graphics

| No.   | Parameter name     | Setting value | Explanation                               |
|-------|--------------------|---------------|-------------------------------------------|
| #8631 | GraphicsBaseAxis_I | X             | Set the same axis name as #1026.          |
| #8632 | GraphicsBaseAxis_J |               | Enter "0" to the rotary axis to be blank. |
| #8633 | GraphicsBaseAxis_K | Z             | Set the same axis name as #1028.          |

**Notes for check method II**

- (1) If you press the cycle start button when an arbitrary part system is being checked, the operation alarm "M01 program check mode" is generated and the cycle start is disabled while the button is held down.
- (2) If you carry out the operation search or check operation (continuous or step check) during cycle start or automatic stop of an arbitrary part system, an operation message "Executing automatic operation" is displayed, and no search or check drawing is carried out.
- (3) "Program check completed" appears with M02/M30 command. For the tape mode, the rewind process is not carried out.
- (4) The check ends with the reset (NC reset or the menu [Check reset]).  
When a program error occurs, cancel the error with the operation indicated above.  
If NC reset is selected when the check screen is being displayed, check drawing ends but the menu to switch to the 2D Check or 3D Check is kept invalid. To enable this switching, press the menu [Check reset].
- (5) During automatic operation, the contents of automatic operation program are displayed by the "Currently executed machining program" (ONB display) and "Buffer display" on the check screen. During checking, the contents of the checking program are displayed by the "Currently executed machining program" (ONB display) and "Buffer display" on the monitor screen.
- (6) If you carry out the operation search or check operation (continuous or step check) when the program is restarted, the "Program restarting" operation message is displayed, and no search or check drawing is carried out.
- (7) If the manual operation mode is selected during checking, the "M01 program check mode" is displayed and the check is stopped. If the mode returns to the memory mode again, the alarm is canceled and the check can be carried on.
- (8) When the PLC Interrupt signal (YC2E) is turned ON during checking, the "M01 Program check mode" is selected. To start the PLC interrupt, terminate the current check by executing a reset. When you turn the PLC interrupt signal OFF, the alarm is released. You can continue the current checking even if the PLC Interrupt signal is ON.
- (9) If the value is rewritten by G10L70 (Parameter command by program), system variables or common variables in the program being checked, the value is rewritten in the same manner as when the program is executed during automatic operation.

- (10) When M code specified by the parameters "#12631 main chuck close M" and "#12632 sub chuck close M" is executed, the workpiece is treated as handed to the front-side spindle or the back-side spindle. When passing, the workpiece is treated as grabbed by the chuck at the position set in the parameters #12633 to #12637 (see the table below).

| M code to be commanded                          | Delivery destination spindle of the workpiece | Destination of the work                                                                                                         |
|-------------------------------------------------|-----------------------------------------------|---------------------------------------------------------------------------------------------------------------------------------|
| M code specified to "#12631 main chuck close M" | Front-side spindle                            | Position specified by the following parameters<br>#12633 main chuck pos X<br>#12634 main chuck pos Y<br>#12635 main chuck pos Z |
| M code specified to "#12632 sub chuck close M"  | Back-side spindle                             | Position specified by the following parameters<br>#12636 sub chuck pos X<br>#12637 sub chuck pos Y<br>#12638 sub chuck pos Z    |

Even when the workpiece is grabbed by both front- and back-side chuck in the actual machining, it is regarded to be grabbed by the chuck whose M code is commanded to close by simulation, shown in the table above.

- (11) When the workpiece is passed, the chucks grab the workpiece regarding the distance between the front-side chuck and back-side chuck as the material length of the workpiece being machined. The distance between front-side chuck and back-side chuck is calculated as the axis position error set with the parameters "#12639 main chuck ax name" and "#12640 sub chuck ax name".

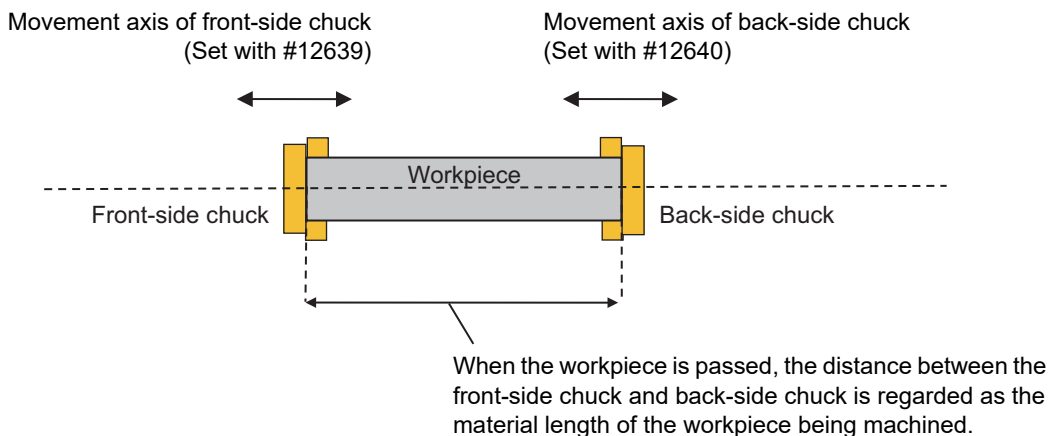

- (12) When the sub part system control I/II commands are executed, the program error (P803) occurs and the check is stopped.
- (13) During tap retract enable state, if the check operations ([Check continu] or [Check step]) is performed, "M01 Wait for tap retract 0057" is displayed and the check cannot be performed in the part system in which the alarm occurred. After the state becomes tap retract enable and tap retract enable operation is completed, the check can be performed.
- (14) When you use the arbitrary axis exchange control function, set all the part systems to be check targets for the graphic check (\*1). When any axis in the part system which is not to be checked is designated, the operation error "M01 Arbitrary axis unexchangeable 1101" occurs, the graphic check cannot be performed in the part system where an alarm is displaying. Change the setting of the parameter or change the machining program.
- (\*1) The part system which is set to "0" by any of the parameters "#8982 CheckSmltns\$1Invl" to "CheckSmltns\$8Invl"

### 4.4 Checking the Tool Command (T Code List)

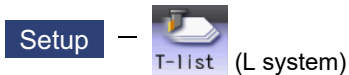

This function searches the T code in designated machining program (including the subprograms) and lists it in the order the T codes are commanded (Max. 100 codes).

As for the T code of the tool that has not been registered, it is indicated with text color and background color changed. Refer to "6.2 Registering a Tool (Tool Registration Screen)" for details on registering a tool.

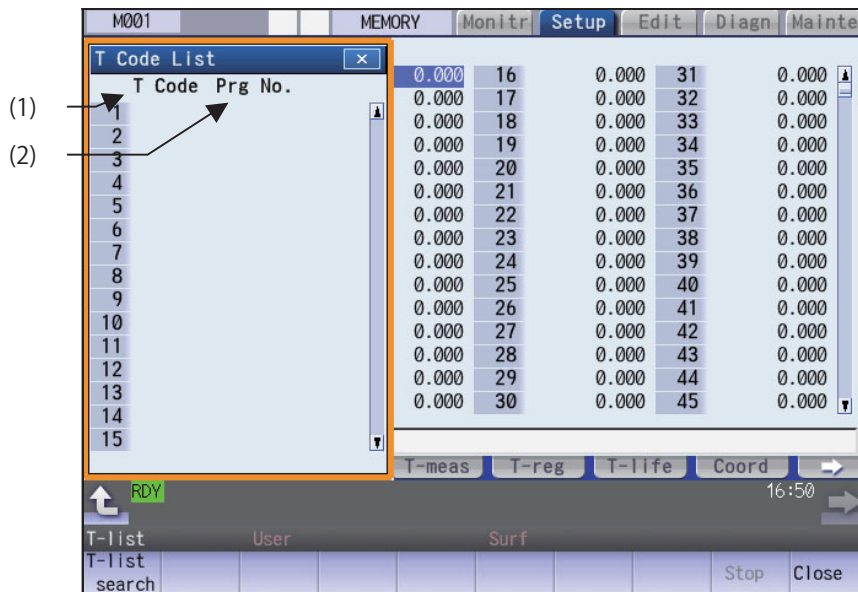

**Display items**

| Display items | Details                                                                                                                                                                                                                                              |
|---------------|------------------------------------------------------------------------------------------------------------------------------------------------------------------------------------------------------------------------------------------------------|
| (1) T code    | T codes are listed in the order that the T code is commanded in the designated machining program (including subprogram). (As for the T code of the tool that has not been registered, it is indicated with text color and background color changed.) |
| (2) Prg No.   | This shows designated program No.<br>When the number of characters exceeds 15, the excess is indicated as "**".                                                                                                                                      |

**Menus**

| Menus         | Details                                                                                    |
|---------------|--------------------------------------------------------------------------------------------|
| T-list search | This designates the program.<br>This menu is invalid while getting the T codes.            |
| Stop          | This interrupts getting the T codes.<br>This menu is valid only while getting the T codes. |
| Close         | This closes the pop-up window and quits this function.                                     |

4.4.1 Searching T List

Press the menu [T-list search] to display the following screen.

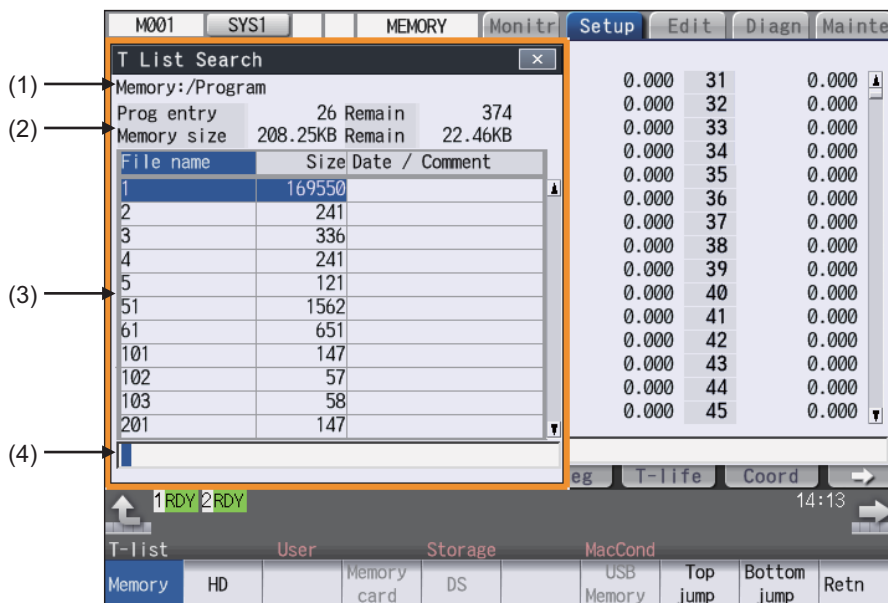

Display items

| Display items                      | Details                                                                                                                                                                                                                                                                                                                                                                                                                                                                                                                                                                                                                                                                                                                                                                                                                                                                                                                                                                                                            |
|------------------------------------|--------------------------------------------------------------------------------------------------------------------------------------------------------------------------------------------------------------------------------------------------------------------------------------------------------------------------------------------------------------------------------------------------------------------------------------------------------------------------------------------------------------------------------------------------------------------------------------------------------------------------------------------------------------------------------------------------------------------------------------------------------------------------------------------------------------------------------------------------------------------------------------------------------------------------------------------------------------------------------------------------------------------|
| (1) Device name, directory display | This displays the device and directory where the searched machining program is located.                                                                                                                                                                                                                                                                                                                                                                                                                                                                                                                                                                                                                                                                                                                                                                                                                                                                                                                            |
| (2) Capacity display               | This displays the capacity of the device displayed in (1).                                                                                                                                                                                                                                                                                                                                                                                                                                                                                                                                                                                                                                                                                                                                                                                                                                                                                                                                                         |
| (3) List of directories and files  | <p>This displays a list of the contents contained in the device or directory displayed in (1).</p> <p>Use  and  to scroll the displayed list.</p> <p>&lt;Displaying "Date/comment" field&gt;</p> <p>When the device is HD, memory card, DS or USB memory, the file update date/time is displayed.</p> <p>For NC memory, the display can be switched as follows depending on the parameter "#8981 NCmemory date disp" setting: (*1)</p> <p>When #8981 is set to "0", the machining program comment is displayed.</p> <p>When #8981 is set to "1", the file update date/time is displayed.</p> <p>Whether to show or hide the comment field can be selected by pressing the menu [Comment nondisp]. When the comment field is hidden, the file name field will be enlarged. (Up to 13 characters can be displayed in the file name field when the comment is shown, and 32 when the comment is hidden.)</p> <p>If the file name exceeds the maximum number of characters, "*" will appear at the last character.</p> |
| (4) Input section                  | This displays details of the key input.                                                                                                                                                                                                                                                                                                                                                                                                                                                                                                                                                                                                                                                                                                                                                                                                                                                                                                                                                                            |



(\*1) For the program list view of the NC memory, the program comment is displayed when the multi-part system program management is valid (#1285 ext21/bit0 = 1), regardless of the parameter setting of "8981 NCmemory date disp".



## Menus



| Menus           | Details                                                                                                                                                                                                                      |
|-----------------|------------------------------------------------------------------------------------------------------------------------------------------------------------------------------------------------------------------------------|
| Memory          | This selects the device for searching for the program.<br>When a device with directory is selected, the root directory is selected first.<br>(For M800S, M80, and E80 Series, [HD] is not displayed and cannot be selected.) |
| HD              |                                                                                                                                                                                                                              |
| Memory card     |                                                                                                                                                                                                                              |
| DS              |                                                                                                                                                                                                                              |
| USB Memory      |                                                                                                                                                                                                                              |
| Top jump        | Display starts from the first page of the directory/list of files. The cursor moves to the top line.                                                                                                                         |
| Bottom jump     | The last page of the directory/list of files is displayed. The cursor moves to the bottom line.                                                                                                                              |
| Comment nondisp | This hides the comment field in the list.<br>The file name field can be enlarged.                                                                                                                                            |
| List update     | This updates the list contents.<br>The latest contents of the currently selected device and directory are listed.                                                                                                            |
| Sort change     | This changes the method that the list is sorted.                                                                                                                                                                             |
| Retn            | This closes the pop-up window and starts getting T codes.                                                                                                                                                                    |

**Displaying the T code list**

- (1) Press the menu [T-list] on Setup screen.
- (2) Press the menu [T-list search].
- (3) Select the device.  
(Example) Memory
- (4) Use the [↑], [↓], , or  key to align the cursor with the directory of target file, and press the [INPUT] key.

<Note>

- ◆ If the list contents differ from the actual device or directory, press the menu [List update].
- ◆ Press the menu [Sort change] to change the sort.  
Sorting method changes to File name ascending order -> File name descending order -> Date/Comment ascending order -> Date/Comment descending order -> File name ascending order -> ..... every time the menu key is pressed.

- (5) Use the [↑], [↓], , or  key to align the cursor with the target machining program, and press the [INPUT] key.  T code list appears as a pop-up window. Getting T code and listing starts. The menu [Stop] becomes valid. The [T-list search] is invalid.

T code list cannot be displayed when [INPUT] key is pressed with the following programs selected:

- The program that does not exist.
- The program being checked.

For M80 series, T code list cannot be displayed when [INPUT] key is pressed with the following programs selected:

- The program during automatic operation.
- The program that is waiting to be restarted. The list window will not change.

**Note**

- (1) When switching to the other screen (monitor screen or edit screen), getting T code is interrupted automatically.
- (2) When the menu [Close] is pressed, getting T code is interrupted automatically.
- (3) For some models, T list search cannot be carried out with manual operation mode (except memory, tape, online, MDI, PC or direct mode). Switch it to automatic operation mode.
- (4) T list search is not available for sub part system I/II for M80 Series. If the search is carried out, the message "Search error" appears.
- (5) T list search is not available for sub part system II for M800 Series. If the search is carried out, the message "Search error" appears.
- (6) T code list for MDI program cannot be displayed.
- (7) T code list of a program with 33 or more file name characters cannot be gotten.
- (8) When you designate the program which occurs a program error, T code list can be gotten up to the previous block of the error. Error message is not displayed.

**Stopping the update of T code list**

It may take time to update the T code list. When the menu [Stop] is pressed while the T code list display is updated, the acquisition of the T code list is stopped.

In this case, the T code list up to the position where it was stopped can be displayed.



## Inputting and Outputting a Machining Program

This chapter explains the details of Inputting and outputting the machining program mainly based on the menu [I/O] on the Edit screen.

This operation can be performed with the menu [I/O] on the Maintenance (Mainte) screen as well.

## 5.1 Inputting and Outputting a Program



The machining program can input/output between the NC internal memory and the external input/output device on the Edit screen. The built-in disk of the display unit inside the NC unit is also treated as an external device.

### Note

(1) When the program input/output function is used, set the parameter "#8923 Hide Edit-IO menu" to "0".

This function applies to the following devices.

- Memory (SRAM memory at NC)
- HD
- Serial
- Memory card (front-side SD card)
- DS (control unit-side SD card)
- Ethernet
- USB memory

[Inputting and outputting of multi-part system program]

When the parameter "#1285 ext21/bit0" (Multi-part system program management) is set to "1" and NC Memory is selected as a device, a program input and output will be executed across all part systems in batch if a parameter "#1285 ext21/bit2" (Multi-part system program generation and operation) is set to "0". When it is set to "1", the program input and output will be executed for the program of displayed part system.

However, when the machining program is transferred from the NC memory to the other device, the transfer will be executed across all part systems in batch if "#1286 ext22/bit5" (Selection of multi-part system program input/output method) is set to "0". If it is set to "1", only displayed part system's program will be transferred.

<During file transmission>

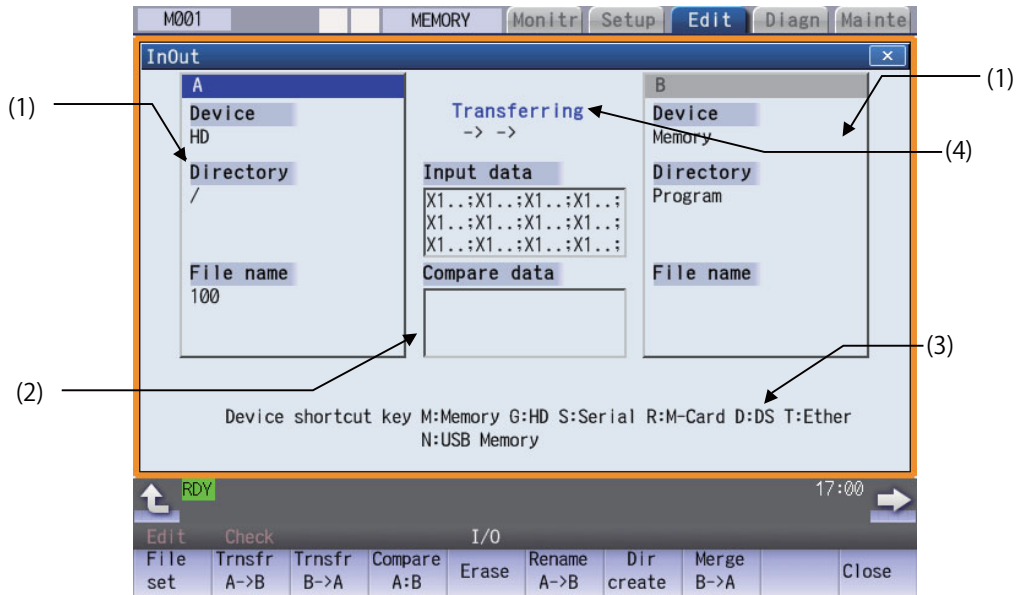

<During file setting>

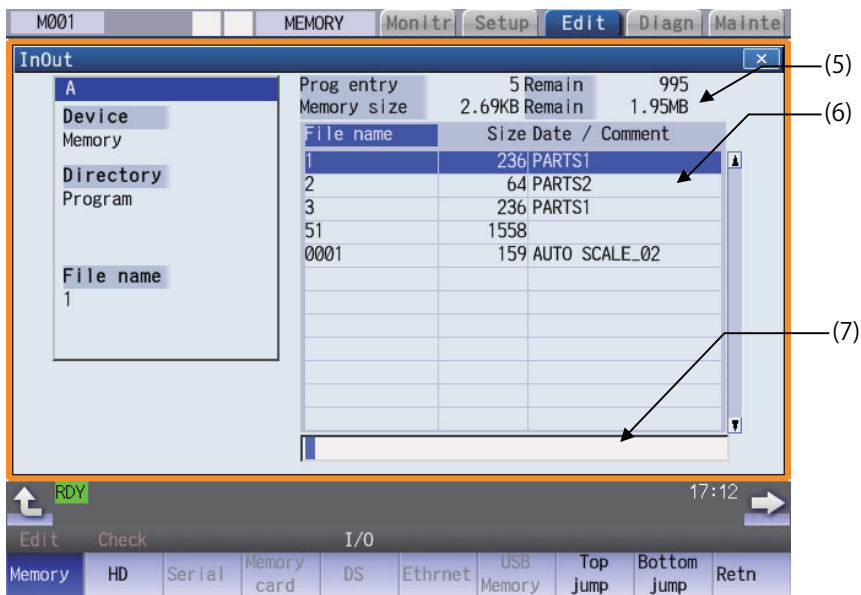

## Display items

| Display items                                 | Details                                                                                                                                                                                                                                                                                                                                                                                                                                                                                                                                                                                                                                                                                                                                                                                                                                                                                                                                                                                                                                                                                                                                                                                                                                                                                                                                                                                                                                                                                                                                                                                                                                                                                                                                                                                                                                                                                                                                                                           |
|-----------------------------------------------|-----------------------------------------------------------------------------------------------------------------------------------------------------------------------------------------------------------------------------------------------------------------------------------------------------------------------------------------------------------------------------------------------------------------------------------------------------------------------------------------------------------------------------------------------------------------------------------------------------------------------------------------------------------------------------------------------------------------------------------------------------------------------------------------------------------------------------------------------------------------------------------------------------------------------------------------------------------------------------------------------------------------------------------------------------------------------------------------------------------------------------------------------------------------------------------------------------------------------------------------------------------------------------------------------------------------------------------------------------------------------------------------------------------------------------------------------------------------------------------------------------------------------------------------------------------------------------------------------------------------------------------------------------------------------------------------------------------------------------------------------------------------------------------------------------------------------------------------------------------------------------------------------------------------------------------------------------------------------------------|
| (1) Device, directory, file name setting area | <p>This sets the device, directory, and file name for which the transmission, compare, and erase functions are used. When the number of characters exceeds the display possible number (directory: 63 in three lines, file name: 63 in three lines), the excess is not displayed.</p> <p>As for the device and directory, the setting values are retained even when the power is turned OFF.</p> <p>When multiple files are selected, the selected file name and "...etc" is displayed in the file name setting area.</p>                                                                                                                                                                                                                                                                                                                                                                                                                                                                                                                                                                                                                                                                                                                                                                                                                                                                                                                                                                                                                                                                                                                                                                                                                                                                                                                                                                                                                                                         |
| (2) Input/compare data display                | <p>This displays data that is being transferred or compared. If an error occurs while comparing data, the block for which the error occurred is displayed.</p>                                                                                                                                                                                                                                                                                                                                                                                                                                                                                                                                                                                                                                                                                                                                                                                                                                                                                                                                                                                                                                                                                                                                                                                                                                                                                                                                                                                                                                                                                                                                                                                                                                                                                                                                                                                                                    |
| (3) Guidance display area                     | <p>This displays the device name shortcut key.</p>                                                                                                                                                                                                                                                                                                                                                                                                                                                                                                                                                                                                                                                                                                                                                                                                                                                                                                                                                                                                                                                                                                                                                                                                                                                                                                                                                                                                                                                                                                                                                                                                                                                                                                                                                                                                                                                                                                                                |
| (4) Process progress display section          | <p>This displays the details and data input/output direction for the process currently being performed.</p>                                                                                                                                                                                                                                                                                                                                                                                                                                                                                                                                                                                                                                                                                                                                                                                                                                                                                                                                                                                                                                                                                                                                                                                                                                                                                                                                                                                                                                                                                                                                                                                                                                                                                                                                                                                                                                                                       |
| (5) Capacity display section (*1)(*2)         | <p>This displays the file (machining program) registration count information and memory capacity information for the selected device.</p> <p>Prog entry: Displays the number of programs that are already registered as the user's machining programs.</p> <p>Remain: This displays the remaining number of programs that can be registered.</p> <p>When memory is selected as the device, the total of the number of programs registered and the remainder is the maximum number of registrations set in the specifications.</p> <p>Memory size: Displays the capacity that is already registered as the user's machining programs.</p> <p>Remain: Displays the remaining capacity that can be registered.</p> <p>When memory is selected, the total of the memory capacity and the remaining capacity is used as the maximum memory capacity defined in the specifications.</p>                                                                                                                                                                                                                                                                                                                                                                                                                                                                                                                                                                                                                                                                                                                                                                                                                                                                                                                                                                                                                                                                                                 |
| (6) List display section (*3)                 | <p>This displays the directory contents list (directory and file name) of the device A or B where the cursor is currently located.</p> <p>When the menu [Commentnondisp] is highlighted, the [Date/Comment] column is not displayed. Up to 32 characters are displayed in the file name column.</p> <p>File name:</p> <ul style="list-style-type: none"> <li>◆When "Memory" is selected for the device, this displays the file name (program No.) of the machining programs already registered. The file names are displayed in order from the smallest number, from 1 to 99999999.</li> <li>◆When a device other than memory is selected, this displays the file name and directory to be included in the directory that is set in the current setting column.</li> <li>◆When the number of characters exceeds the maximum (13 characters with the comment column, 32 characters without the comment column), the excess is indicated as "***".</li> </ul> <p>Size:</p> <ul style="list-style-type: none"> <li>◆This displays the size of each file. (The number of characters in the machining program when the memory is selected for the device.)</li> <li>◆When directory is selected, this displays "DIR".</li> </ul> <p>Date/Comment:</p> <ul style="list-style-type: none"> <li>◆This displays the comment (up to 19 alphanumeric characters and symbols) of each file.</li> <li>◆The date which the file is updated is displayed for the HD, memory card, DS, USB memory or Ethernet.</li> <li>◆For NC memory, the display can be switched as follows depending on the parameter "#8981 NCmemory date disp" setting: (*4)<br/> When #8981 is set to "0", the machining program comment is displayed.<br/> When #8981 is set to "1", the file update date/time is displayed.</li> <li>◆When the comment of the NC memory exceeds the number of display characters (19 characters), the exceeded part is not displayed. The excess is not abbreviated to "***".</li> </ul> |
| (7) Input section                             | <p>This displays the input key.</p>                                                                                                                                                                                                                                                                                                                                                                                                                                                                                                                                                                                                                                                                                                                                                                                                                                                                                                                                                                                                                                                                                                                                                                                                                                                                                                                                                                                                                                                                                                                                                                                                                                                                                                                                                                                                                                                                                                                                               |

(\*1) Some items may not be displayed depending on the device.

○: Displayed      ×: Not displayed

| Display item/Device           | Memory | HD | Serial | Memory card | DS/USB Memory | Ethernet |
|-------------------------------|--------|----|--------|-------------|---------------|----------|
| Number of programs registered | ○      | ○  | ×      | ○           | ○             | ○        |
| Remain                        | ○      | ×  | ×      | ×           | ×             | ×        |
| Number of memory characters   | ○      | ○  | ×      | ○           | ○             | ○*       |
| Remain                        | ○      | ○  | ×      | ○           | ○             | ×        |
| List                          | ○      | ○  | ×      | ○           | ○             | ○        |

\* When the parameter "#97\*1 Host n no total siz" is set to "1", the number of host memory characters will not appear.

(\*2) When the device is not mounted, a registration count and a memory capacity are not displayed and an empty list is displayed.

(\*3) When the device is serial, an empty list is displayed.

(\*4) For the program list view of the NC memory, the program comment is displayed when the multi-part system program management is valid (#1285 ext21/bit0 = 1), regardless of the parameter setting of "8981 NCmemory date disp".

## Note

- (1) As for the device and directory, the setting values are retained even when the power is turned OFF. However, by selecting directory, when the number of characters in the directory path (full path) from the root directory exceeds 100, the directory path is not retained, but a previously set directory path containing 100 characters or less retained. When the device is "Memory", the initial directory display is "Program". When the device is "Ethernet", refer to "Initial directory when the Ethernet is selected" in "5.2 Selecting a Device, Directory and File" for details about the initial directory display.

## Menus

| Menus       | Details                                                                                                                                                                                                                                                                |
|-------------|------------------------------------------------------------------------------------------------------------------------------------------------------------------------------------------------------------------------------------------------------------------------|
| File set    | This sets the device, directory and file name for which input/output operations are performed.<br><Note><br>♦When the device is serial or nothing, an empty list is displayed. When the device is not mounted, an operation message "(Device name) not ready" appears. |
| Trnsfr A->B | This copies the file in file setting column A (transfer origin) to the file setting column B (transfer destination). (The transfer origin file is not changed.)                                                                                                        |
| Trnsfr B->A | This copies the file in file setting column B (transfer origin) to the file setting column A (transfer destination). (The transfer origin file is not changed.)                                                                                                        |
| Compare A:B | This compares the files in file setting column A and file setting column B.                                                                                                                                                                                            |
| Erase       | This erases the selected file in file setting column.                                                                                                                                                                                                                  |
| Rename A□ B | This changes the name of the file in file setting column A to that of in file setting column B.<br><Note><br>♦The same device must be selected for A and B.                                                                                                            |
| Dir create  | This creates a new directory in the selected file setting column.<br>The directory can be created when HD is selected for the device.                                                                                                                                  |
| Merge B□ A  | This adds the contents of the file in file setting column B to that of in file setting column A. (The file in file setting column B is not changed.)                                                                                                                   |
| Close       | This closes the pop-up window and quits this function.                                                                                                                                                                                                                 |



| Menus             | Details                                                                     |
|-------------------|-----------------------------------------------------------------------------|
| MemCrd<br>format  | Format the memory card (front-side SD card).                                |
| DS<br>format      | Format the memory card DS (built-in SD card).                               |
| USB Mem<br>format | Format the USB memory.                                                      |
| Stop              | This interrupts the process (transfer, compare, etc.) during its execution. |

## Sub-menus of [File set] menu

| Menus              | Details                                                                                                                                                |
|--------------------|--------------------------------------------------------------------------------------------------------------------------------------------------------|
| Memory             | This selects NC memory.                                                                                                                                |
| HD                 | This selects the hard disk.<br>This is not displayed on M800S Series, M80 Series, E80 Series, and non-Windows-based display unit of M800W/M80W Series. |
| Serial             | This selects the RS-232C device (PC, tape, etc.).                                                                                                      |
| Memory<br>card     | This selects the front-side SD card.                                                                                                                   |
| DS                 | This selects the built-in SD card.                                                                                                                     |
| Ethnet             | This selects the Ethernet-connected host computer.                                                                                                     |
| USB<br>Memory      | This selects USB memory.                                                                                                                               |
| Top<br>jump        | This moves the cursor to the top line.                                                                                                                 |
| Bottom<br>jump     | This moves the cursor to the last line.                                                                                                                |
| Comment<br>nondisp | This changes whether to show or hide the comment field.<br>When the comment is hid, the menu is highlighted.                                           |
| Program            | This transfers a machining program as one file.                                                                                                        |
| Program<br>all     | This transfers multiple programs as one file.                                                                                                          |
| Multi-<br>files    | This menu is used when you select multiple files and perform the operation such as file transfer or file deletion.                                     |
| List<br>update     | This updates the list contents. (The latest contents of the currently selected device and directory are listed.)                                       |
| Sort<br>change     | This changes the method that the list is sorted.                                                                                                       |
| Retn               | This returns to the main menu.                                                                                                                         |

Sub-menus of [Multi-files]

| Menus        | Details                                                                                           |
|--------------|---------------------------------------------------------------------------------------------------|
| Select range | This sets the last line of the multiple-file selection starting from the current cursor position. |
| Select all   | This selects all files                                                                            |
| Cancel all   | This cancels the selection of all files.                                                          |
| fix          | This selects the file where the cursor is currently located.                                      |
| De-select    | This cancels the file selection where the cursor is currently located.                            |
| fix          | This fixes the file selection to return the main menu.                                            |
| Retn         | This cancels the multiple-file selection to return the main menu.                                 |

#### Switching the valid area

It is necessary to enable the areas including device, directory, and file name in the file setting column A or B in order to set those items.

Change the display area using the [←], [→], direction cursor keys or the [[←], [→]] tab keys.

For the touchscreen display, it is also possible to change the invalid area by touching the display area.

## 5.2 Selecting a Device, Directory and File



This section explains the file device, directory, and file name specification methods for the file transfer and erase commands etc. performed on the I/O screen of the edit (Edit) screen.

### File operation procedure

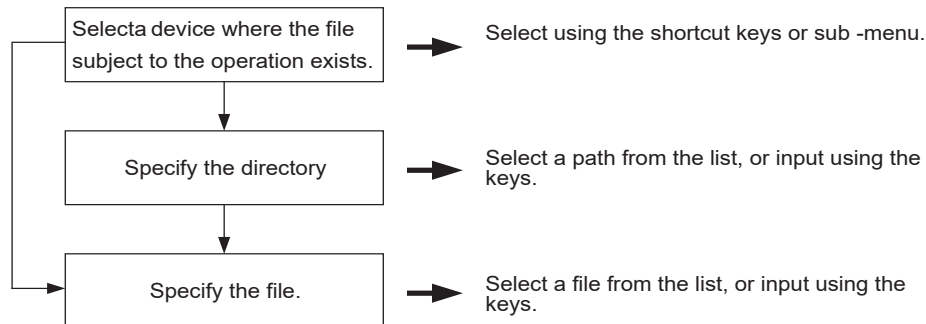

### Outline of device, directory, and file name designating methods

| Device                          | Designation target file                                                                                                         | Designation method                |                                                          |                                                          |
|---------------------------------|---------------------------------------------------------------------------------------------------------------------------------|-----------------------------------|----------------------------------------------------------|----------------------------------------------------------|
|                                 |                                                                                                                                 | Device                            | Directory                                                | File name                                                |
| NC memory                       | <ul style="list-style-type: none"> <li>•Machining program</li> <li>•User macro program</li> <li>•Fixed cycle program</li> </ul> | Select from the submenu           | —<br>(Default)                                           | Key input in the input area, then press the [INPUT] key. |
|                                 |                                                                                                                                 | Designate using the shortcut key. |                                                          | Select from the list.                                    |
| Device other than the NC memory | All files                                                                                                                       | Select from the submenu           | Key input in the input area, then press the [INPUT] key. | Key input in the input area, then press the [INPUT] key. |
|                                 |                                                                                                                                 | Designate using the shortcut key. | Select from the list.                                    | Select from the list.                                    |

- (1) The device can be selected using the sub-menu or shortcut keys.  
(The devices that can be used will differ depending on the specifications.)
- (2) One of the following methods can be used to designate the directory (for devices other than the NC memory) and file name.
  - Designate the directory path or file name in the input area and press the [INPUT] key.
  - Move the cursor in the list display section to the target directory or file name and press the [INPUT] key.  
A wildcard (\*) can be used for the file name.

### Note

- (1) If the number of full path characters exceeds 128 when the directory is being moved, it results in a movement failure.
- (2) In the NC memory, you cannot use the cursor movement key or [INPUT] key to move the directory.
- (3) The file name and directory name must be designated using less than 64 characters. If the file name or directory name is designated using 64 or more characters, it may not be recognized as the file name or directory name.
- (4) If a directory that contains a double-byte code file name such as a Japanese file name is displayed in list view, such a double-byte code file name is not displayed correctly. In addition, the number of file characters, comments, and number of stored characters is not displayed correctly.

**Notes when selecting a file**

- (1) During directory and file name setting, the designated directory, path or file name will be set, even if it does not actually exist. This will not cause an error. Note that the previously set directory is overwritten.
- (2) When selecting a fixed cycle program, it is necessary to set the parameter "#1166 fixpro". Furthermore, select "Memory" for the device, and "Program" for the directory.

**Initial directory when the Ethernet is selected**

If you reboot the system while the previously selected device is "Ethernet", or if you select Ethernet initially after startup, the initial directory will be the host directory that is set by the parameter (#9714, #9734, #9754 or #9774) when the HMI starts up.

The directory to be applied varies depending on the setting of the parameter "#9706 Host No.".

**Operation method (Selecting an NC memory program)**

- |                                                                        |   |                                                                             |
|------------------------------------------------------------------------|---|-----------------------------------------------------------------------------|
| (1) Press the [M] short cut key. on the I/O screen of the edit screen. | ➔ | The device name changes to "Memory".<br>"Program" appears in the directory. |
| (2) Press the menu [File set].                                         | ➔ | The NC memory program list and input area appear.                           |

By pressing the operation menu at this point, it is possible to change the device.

When the menu [Program] or [Program all] is selected, the setting of "File name" column is cleared.

Only when the device functions as the memory, the menu [Program] or [Program all] is valid.

<When selecting the file name from the list>

- (3) Move the cursor to the file name to be selected, and set.

[↑], [↓] [INPUT]

<When inputting the file name from the input area>

- (3) Input the file name.

10013 [INPUT]

**Designating multiple files**

A wildcard (\*) can be used for the file name.

By using a wildcard, multiple files can be transferred, compared, and erased at one time.

■(Example 1) When programs 1 to 1000 exist in the NC memory.

Designate "\*" in the file name: The target program is "1 to 1000".

Designate "\*.\*" in the file name: There is no target program.

Designate "1\*" in the file name: The target program is "1, 10 to 19, 100 to 199, 1000".

Designate "1\*.\*" in the file name: There is no target program.

Designate "\*\*1" in the file name: The target program is that where the position of the 1 is "1".

(1, 11, 21, 31, ..... 101, 111, ..... 981, 991)

Designate "\*\*1\*" in the file name: The target program is all of the programs containing "1".

(1, 10 to 19, 21, 31, ..... 100 to 199, 201, 210, ..... 981, 991, 1000)

Designate "1\*1" in the file name: The target program is "11, 111, 121, 131, 141, 151, 161, 171, 181, 191".

■(Example 2) When programs 1.PRG to 1000.PRG, and 1 to 1000 exist in the USB memory.

Designate "\*" in the file name: The target program is "1 to 1000".

Designate "\*.\*" in the file name: The target program is "1.PRG to 1000.PRG".

Designate "1\*" in the file name: The target program is "1, 10 to 19, 100 to 199, 1000".







Designate "1\*.\*" in the file name: The target program is "1.PRG, 10.PRG to 19.PRG, 100.PRG to 199.PRG, 1000.PRG".

**Operation method (Selecting multiple files from the list)**

You can select multiple files from the file list and perform the operation such as file transfer or file deletion. The status multiple files are being selected is canceled when a file transfer to the other device is performed or when any file among selected files is erased.

**Note**





- (1) If you perform file operation such as copying or deletion to the file in the folder which multiple files are being selected, the file selection may be unintended condition due to change of the file list.
- (2) When any of the menu operations ([Trnsfr A→B], [Trnsfr B→A], [Erase], Format menus, [Sort change], [List update]) is performed for the device which multiple files are being selected, the selection is canceled.
- (3) Multiple-file selection is canceled when the I/O screen is closed.
- (4) Directories can also be selected with the multiple-file selection function. However, directories can not be transferred, compared or erased.
- (5) Multiple file selection is available in the range from the first file (including its directory) to 5000th file. When the menu [Select all] is pressed, the files up to the 5000th one are selected.

- (1) Press the menu [File set].
  - ➔ The capacity and the input area of the active device are displayed.  
The program list of the NC memory is displayed.  
The menu [Memory] is highlighted.
- (2) Press the menu "Multi-files" on the 2nd page.
  - ➔ The sub-menus of multiple-file selection function are displayed.
- (3) Select files.
  - <When you select files one by one>
    - (a) Use the [↑], [↓], , or  key to align the cursor with the target file, and press the menu [Select] or press [→] or [←] key.
      - ➔ The background color of the selected file changes.
    - (b) Repeat the operation (a) to select multiple files.
  - <When you select the files in a range>
    - (a) Use the [↑], [↓], , or  key to align the cursor with the first file, and press the menu [Select range].
      - ➔ The menu [Select range] is highlighted.  
The message "Move cursor to end posn and press INPUT." appears.
    - (b) Use the [↑], [↓], , or  key to align the cursor with the last file.
      - ➔ When the cursor is moved, the background color of the file in the selection range changes.
    - (c) Press the [INPUT] key.
      - ➔ The range of the selected files is determined.  
The background color for the range of the selected files changes.  
The highlight of the menu [Select range] is canceled.
- (4) Press the menu [fix] or [INPUT] key.
  - ➔ Multiple files selection has been determined.  
The list display is canceled to back to the normal display, and the selected file name is displayed.

**Canceling the file selection**

- (1) <When you cancel the selection for a single file>  
Move the cursor to the file which you want to cancel the selection, and press the menu [De-select] or press [→] or [←] key.
- <When you cancel the selection for all files>  
Press the menu [Cancel all].
- (2) Press the menu [fix] or [INPUT] key.

**Operation method (Selecting a file from a device other than the NC memory)**

- (1) Press a device selection shortcut key on the I/O screen of the edit screen.  The device name changes to "USB memory". The root directory (/) appears in the directory.
- (Example) [N]
- (2) Press the menu [File set].  The program list of the USB memory and the input area appear.
- By pressing the operation menu at this point, it is possible to change the device.  
Only when the device functions as the memory, the menu [Program] or [Program all] is valid.
- <When selecting the directory from the list>
- (3) Move the cursor to the directory to be selected and set.  The directory selected in the directory column appears. The contents of the selected directory appear in the list. Select ".." to move to one directory above. There is no change when "." is selected.
- [↑], [↓] [INPUT]
- Repeat this operation until the cursor arrives at the target directory.  
Next, refer to operation (4).
- <When inputting the directory from the input area>
- (3) Input the directory path.  The input directory path appears in the directory column.
- (Example) /PRG/PRECUT [INPUT]
- <When selecting the file name from the list>
- (4) Move the cursor to the file name to be selected, and set.
- [↑], [↓] [INPUT]
- <When inputting the file name from the input area>
- (4) Input the file name.
- 10013.PRG [INPUT]



## 5.3 Transferring a File



This section explains the method used to transfer files between different devices, or between the same device on the I/O screen of the edit (Edit) screen.

Refer to "5.2 Selecting a Device, Directory and File" for details of the device, directory, and file specification method.

### Operation method

- (1) Use the [←] or [←] key to select file setting column A on the I/O screen of the edit screen.
- (2) Designate the transfer source device, directory and file name.  The designated file displays in file setting column A. A wildcard "\*" can be used for the file name to designate multiple files.
- (3) Use the [→] or [→] key to select file setting column B.
- (4) Designate the transfer destination device, directory and file name.
- (5) Press the menu [Trnsfr A→B].  
Press the menu [Trnsfr B→A] when transferring from device B to device A.
- (6) Press the [Y] or [INPUT] key.  File transfer is commenced. The process progress display area displays message indicating that transfer is in progress, and also indicates the transfer direction. The data being merged appears in the input/comparison data display area input data display column. A message appears indicating a transfer completion after transfer has been completed.

### CAUTION

 ";", "EOB", "%", and "EOR" are symbols used for explanation. The actual codes for ISO are "CR, LF" ("LF") and "%". "%" and "EOR" are represented by "%" in ISO. The programs created on the edit screen are stored in the NC memory in a "CR, LF" format, however, the programs created with external devices may be stored in an "LF" format. The actual codes for EIA are "EOB (End of Block)" and "EOR (End of Record)".

 To prevent influence from data omission and data transformation in the communication circuit, always verify the data after inputting and outputting machining programs.



## Precautions

### ■Notes related to transferring in general

- (1) Depending on the type of file, some data cannot be transferred during automatic operation. Do not transfer during automatic operation.
- (2) When the capacity of the transfer destination is reached during file transfer, only the data transferred up to that point is registered as a file, and an error will occur.
- (3) During input to the NC memory or comparison, if the file format size on the NC memory side differs from the other side file format size (when the maximum number of registrations differs between the NC memory and the other side), processing is carried out matched to the smaller size.  
 (Example 1) If a format size of 200 files is input for a format size of 1000 NC files, 200 files are registered.  
 (Example 2) If 1000 files are input to the NC that formatted for 200 files, the files up to the 200th file can be registered and an error message appears. (The remaining files are not registered.)
- (4) Do not perform any file operation on the transfer source and destination files during the file transfer. The file may be damaged with the file operation.

### ■Notes when transferring machining program files

- (1) For the serial, always set both ends of the "EOR" code at the head and end to feed (NULL). If "EOB" etc., is directly after "EOR", the operation may not be executed normally due to the input buffer influence during the next input operation.
- (2) The transfer speed is slower if there are many registrations.
- (3) The size of one block of the machining program should be 250 characters or less.
- (4) The characters that can be used for the file name and directory path are 1-byte number, 1-byte capital alphabetical letters, and 1-byte symbols recognized by the system. Note that the following characters cannot be used.  
 |, /, :, ", " (comma), \*, ?, ", <, >, a to z (small letters), space  
 Up to 32 characters are allowed for the file name to create in or transfer to NC memory.
- (5) If the file whose name includes lower case alphabet is transferred to NC memory, the lower case letter will be converted into the capital letter.
- (6) When using tape, carry out parity V adjustment to improve the reliability of the tape format. Then use with the parameter "Parity V" validated.
- (7) When the MTB macro and fixed cycle program are input, change the program type with the parameter (#1166 fixpro). Also, set the device and directory as follows.  
 Device: Memory, Directory: Program
- (8) Transferring or verifying the multiple files between the external device connected serially and that other than the serial connection.
- (9) With machining program created by the MELDAS500 Series or earlier model, "EOB" is registered as "LF". However, when these programs are stored in the M800/M80 Series NC memory, "EOB" will be converted to "CR LF", and the number of characters will increase. Thus, when all of the machining programs output from an MELDAS500 Series or earlier model, having the same specifications as the maximum memory capacity, are stored in the M800/M80 Series NC memory, the memory capacity may be exceeded.
- (10) When the file to be transferred (input) is running or in "program restarting" mode, the operation message "Executing automatic operation" or "Program restarting" is displayed and file will not be transferred (input).
- (11) If the file to be transferred (input) is being edited on the custom screen, the operation message "Can't write into being edited file" appears and may not be transferred (input).
- (12) When "#8936 Delete leading 0" is set to "1", if a file name consisting only of numerical figures is input, "0" at the head of the file name is deleted to be checked.  
 However, if the file name is out of the range between 1 and 999999999, the leading "0" is not deleted. This also applies to MTB macros.  
 Therefore, for example, while the program "1" is in automatic operation, if a file name to transfer (input) is named "0001", the operation message "Executing automatic operation" appears, and transfer cannot be carried out.  
 In the case of fixed cycles, regardless of the setting of "#8936 Delete leading 0", the name of the file to transfer must be 9 digits, and it must not start from "0". Attempting to transfer a file whose name does not satisfy the conditions above will cause an error.
- (13) If the file to be transferred (input) is targeted for edit lock (edit lock B: 8000 to 9999 or edit lock C: 9000 to 9999), the operation message "Edit lock B" or "Edit lock C" is displayed, causing a transfer failure.  
 If "#8936 Delete leading 0" is set to "1" and the program name consisting only of numerical figures is input, "0" at the head will be deleted and checking will be performed. (Example: If the transferring (inputting) file name is "008000", the operation message "Edit lock B" appears and it cannot be transferred.)

- (14) When the multi-part system program management is valid (#1285 ext21/bit0 =1) and ""#1285 ext21/bit2" (Multi-part system program generation and operation) is set to "0", the machining program's transfer to the NC memory from the device other than the NC memory is executed across all part systems in batch. When it is set to "1", only displayed part system's machining program will be transferred.
- (15) When the multi-part system program management is valid (#1285 ext21/bit0 =1) and "#1286 ext22/bit5" (Selection of multi-part system program input/output method) is set to "0", the machining program's transfer from the NC memory to the device other than the NC memory will be executed across all part systems in batch. When it is set to "1", only displayed part system's machining program will be transferred.
- (16) The transfer range from the external device other than serial to NC memory will change depending on the value set in the parameter "#19006 EOR Disable".
- <When the parameter "#19006 EOR disable" is set to "0">  
 The head line will not be transferred.  
 Up to "%" in the second line onward will be transferred, and data after "%" will not be transferred.  
 If there is no "%", all data will be transferred.
- <When the parameter "#19006 EOR disable" is set to "1">  
 All file contents will be transferred.
- (17) When multiple files are designated to be transferred in the following ways, the transfer is executed excluding the programs which are subject to the edit lock in accordance with the status of Edit lock B and C.
- A wildcard "\*" is used in the file name.
  - Multiple files are selected from the list.
- (18) If the device shown below and the directory are designated for the transfer destination, the following operation is performed depending on conditions.
- When an existing file is designated: The file is transferred with a temporary file name, and changed to the designated file name after transfer processing has been completed.
  - When a new file is designated: A new file is transferred with a temporary file name, and changed to the designated file name after transfer processing has been completed.
- (1) Transfer destination device: Memory  
 Directory: Machining program
- (2) Transfer destination device: DS, memory card, USB memory (\*1)
- A temporary file is designated by the file name that consists of 11 digits, beginning with the symbol "~".  
 After transfer is terminated properly, the temporary file is changed to the designated file name.  
 A temporary file remains in the cases below, but can be deleted in the same way as for a normal file.
- When the transfer has terminated abnormally, for example, because the destination's capacity became full.
  - When the transfer has been interrupted.
- (\*1) Memory card and USB memory support the following models:
- M800S
  - M80
  - E80
  - Non-Windows-based display unit of M800W
  - Non-Windows-based display unit of M80W

## 5.4 Comparing Files (Compare)



This section explains method used compare files after transferring on the I/O screen of the edit (Edit) screen. Refer to "5.2 Selecting a Device, Directory and File" for details of the device, directory, and file specification method.

### Operation method

- (1) Use the [←] or [I←] key to select file setting column A on the I/O screen of the edit screen.
- (2) Designate the device, directory and file name to be compared.
- (3) Use the [→] or [I→] key to select file setting column B.
- (4) Designate the other device, directory and file name to be compared.
- (5) Press the menu [Compare A:B].
 



The file comparison starts. The input data and comparison data appear in the input/comparison data display area. A message appears when the comparison is completed. If a comparison error occurs, the block with the error is displayed in the comparison data display column on the screen.

### Note

- (1) Files that can be compared are text files only. Correct outcome will not be obtained through binary file comparison.
- (2) In a file comparison, even if "#8936 Delete leading 0" is set to "1", when comparing one separate file that contains one program, "0" at the head of the program name is not deleted. Designating the file name is required. However, in the case of serial/batch file, comparison is carried out with a leading zero in the program name deleted.
- (3) Designating "\*" for the compared file name causes "Setting error" when the comparison is executed with serial. Designate no file name or designate a target file name.
- (4) When multiple files are designated for the transfer source file in the following ways, the comparison is executed excluding the programs which are subject to the edit lock in accordance with the status of Edit lock B and C.
  - ♦A wildcard "\*" is used in the file name.
  - ♦Multiple files are selected from the list.

## 5.5 Erasing a File



This section explains the method used to erase files on the I/O screen of the edit (Edit) screen.

Refer to "5.2 Selecting a Device, Directory and File" for details of the device, directory, and file specification method.

### Operation method (Erasing a file in file setting column A)

- (1) Use the [←] or [←] key to select file setting column A on the I/O screen of the edit screen.
- (2) Designate the device, directory and file name to be erased.
- (3) Press the menu [Erase].
- (4) Press the [Y] or [INPUT] key.

### Note

- (1) If the file to be erased is running, an error will occur, and the file will not be erased.
- (2) If the file to be erased is being edited on the custom screen, the operation message "Can't erase designated file" appears and may not be erased.
- (3) When multiple files are designated to be erased in the following ways, the erasing is executed excluding the programs which are subject to the edit lock in accordance with the status of Edit lock B and C.
  - A wildcard "\*" is used in the file name.
  - Multiple files are selected from the list.

### Operation method (Erasing a file in file setting column B)

Use the [→] or [→] key to select file setting column B, and designate the device, directory, and file name for file setting column B. Following this, the operation method is same as for "Erasing a file in file setting column A".

## 5.6 Changing a File Name (Rename)



This section explains the method used to change the file name on the I/O screen of the edit (Edit) screen. Refer to "5.2 Selecting a Device, Directory and File" for details of the device, directory, and file specification method.

### Changing a file name

- (1) Use the [←] or [I←] key to select file setting column A on the I/O screen of the edit screen.
- (2) Designate the original device, directory and file name.
- (3) Use the [→] or [I→] key to select file setting column B.
- (4) Designate the new device, directory and file name.
- (5) Press the menu [Rename A→B].
- (6) Press the [Y] or [INPUT] key.

### Note

- (1) Make sure the original and new devices are the same.
- (2) If the file to be renamed is running or program restarting, an error will occur, and the name will not be changed.
- (3) If the file to be renamed is being edited on the custom screen, the operation message "Can't rename designated file" appears and may not be changed.
- (4) If a file that does not exist is designated for the original file, or if an existing file name is designated for the new file selection, an error occurs, and the name is not changed.
- (5) The directory where the file in operation search/check search is stored cannot be renamed. The operation message "Can't rename designated file" appears.

## 5.7 Creating a Directory



This section explains the method used to newly create a directory.

Refer to "5.2 Selecting a Device, Directory and File" for details of the device, directory, and file specification method.

### Operation method

- (1) Use the [←] or [↵] key to select file setting column A.
- (2) Designate the device.
- (3) Select a directory to be newly created from the list, or designate by inputting from the input area.
- (4) Set the new directory in the file setting column A. → The directory contents appear.
- (5) Press the menu [Dir create].  
The directory can also be created in file setting column B. → The directory is created.

### Note

- (1) Make sure that the directory path is less than 64 characters. If the directory name is designated using 64 or more characters, it may not be recognized as the directory name.

## 5.8 Other Functions



### 5.8.1 Merging a File

This section explains the method used to add a file in file setting column B to a file in file setting column A on the I/O screen of the edit (Edit) screen.

Refer to "5.2 Selecting a Device, Directory and File" for details of the device, directory, and file specification method.

#### Operation method

- (1) Use the [←] or [I←] key to select file setting column A on the I/O screen of the edit screen.
- (2) Designate the merge destination device, directory, and file name.
- (3) Use the [→] or [I→] key to select file setting column B.
- (4) Designate the merge source device, directory, and file name.
- (5) Press the menu [Merg B→A].
- (6) Press the [Y] or [INPUT] key.



The file merge starts. The data being merged appears in the input/comparison data display area input data display column. Furthermore, a message indicating that merging is being performed, and an arrow from the merge source (file setting column B) to the merge destination (file setting column A) display in the process progress display area.

A message appears when the merge is completed. The details of the file in file setting column A will be as follows when the merge is completed.

|                                                                                                           |                                                          |
|-----------------------------------------------------------------------------------------------------------|----------------------------------------------------------|
| <pre>(FILE A) G28 XYZ G90 F800 G00 X100. Y100.; (FILE B) G91 G28 XYZ F1000; G01 X200. Y200.; M02; %</pre> | } Details of file in file setting column A before merge. |
| <pre>(FILE B) G91 G28 XYZ F1000; G01 X200. Y200.; M02; %</pre>                                            | } Details of file in file setting column B before merge. |

The details of the file in file setting column B do not change.

#### Note

- (1) If the merge destination file (file in file setting column A) is running, an error will occur, and the files will not be merged.
- (2) If the merge destination file (file in file setting column A) is being edited on the custom screen, the operation message "Can't write into being edited file" appears and may not be changed.
- (3) The devices that can be merged are the memory, HD, memory card, DS and USB memory.
- (4) Do not perform the file operation on the merge source and destination files during the merge. The file may be damaged with the file operation.

## 5.8.2 List of File Names

There is a directory for each type of data in the device [Memory].

Each directory and file name (fixed) in the device is shown below.

Do not change the extensions (.XXX) when storing in a device other than [Memory].

| Data type           | NC memory directory path | File name     |
|---------------------|--------------------------|---------------|
| Machining program   | /PRG/USER                | (Program No.) |
| Fixed cycle program | /PRG/FIX                 | (Program No.) |

## 5.8.3 Edit Lock B and C

This function prohibits editing, erasing, etc., of the machining programs B and C, and protects the machining programs in the device [Memory].

| Machining program                            | Edit Lock B        | Edit Lock C        |
|----------------------------------------------|--------------------|--------------------|
| A<br>1 to 7999<br>10000 to 99999999          | ---                | ---                |
| B<br>(user standard program)<br>8000 to 8999 | Editing prohibited | ---                |
| C<br>(MTB custom)<br>9000 to 9999            | Editing prohibited | Editing prohibited |

The operations below in the Edit MDI and the Input/Output screens are influenced by the edit lock setting.

An error will occur if operations that are not possible are attempted.

When the edit lock is valid, processing is executed (except the edit lock target program) by the input/output function.

○: Operation possible      ×: Operation not possible

| Screen              | Operation         | Edit Lock B       |   |   | Edit Lock C       |   |   |
|---------------------|-------------------|-------------------|---|---|-------------------|---|---|
|                     |                   | Machining program |   |   | Machining program |   |   |
|                     |                   | A                 | B | C | A                 | B | C |
| Edit                | Search            | ○                 | ○ | × | ○                 | ○ | × |
|                     | Edit              | ○                 | × | × | ○                 | ○ | × |
|                     | MDI registration  | ○                 | × | × | ○                 | ○ | × |
| Edit (Input/Output) | Transfer          | ○                 | × | × | ○                 | ○ | × |
|                     | Compare           | ○                 | × | × | ○                 | ○ | × |
|                     | Copy              | ○                 | × | × | ○                 | ○ | × |
|                     | Merge             | ○                 | × | × | ○                 | ○ | × |
|                     | Rename            | ○                 | × | × | ○                 | ○ | × |
|                     | Erase             | ○                 | × | × | ○                 | ○ | × |
| Monitor             | Buffer Correction | ○                 | × | × | ○                 | ○ | × |

**Note**

- (1) When the multiple part system specification is valid, the machining programs of all the part systems are protected by edit lock B and C.
- (2) When multiple serial files or a wildcard (\*) is designated for input/output function, programs except subject to edit lock will be processed.
- (3) When a multiple programs are input to the memory without designating the file name like serial input or program batch input, the message "Edit lock B" or "Edit lock C" appears and the input is interrupted if the program which is subject to edit lock is detected.
- (4) A machining program in the USB memory is assumed as machining program A whatever its file name is, it is not subject to the protection of Edit Lock B or C.



## 5.8.4 Program Display Lock

Program display and operation search in the device [Memory] on the monitor or edit screen are affected as follows according to the setting of the parameter "#1122 pglk\_c" (Program display lock).

## Influences of program display lock parameter on monitor screen

| Screen operation #1122 pglk_c                                         | 1 (Display: Prohibited, Search: Possible)                                                                                                                  | 2 (Display: Prohibited, Search: Prohibited)                                                                                                                  |
|-----------------------------------------------------------------------|------------------------------------------------------------------------------------------------------------------------------------------------------------|--------------------------------------------------------------------------------------------------------------------------------------------------------------|
| Buffer display of operating program                                   | The program contents are not displayed. Only "%" is displayed.                                                                                             |                                                                                                                                                              |
| Display when [Program display] highlights on the 2D check full-screen | The program contents are not displayed. Only "%" is displayed. (Drawing is performed.)                                                                     |                                                                                                                                                              |
| Display when [Program display] highlights on Trace full-screen        |                                                                                                                                                            |                                                                                                                                                              |
| When the menu [Edit] was pressed                                      | The operation message "Program display lock C" appears. The window is opened. (When the edit lock B or C is valid, edit lock B or C is given to priority.) |                                                                                                                                                              |
| When the main menu [P corr] was pressed                               |                                                                                                                                                            |                                                                                                                                                              |
| Search from the operation search window                               | The search can be executed.                                                                                                                                | The search cannot be executed. The operation message "Program display lock C" appears. The window is not closed. The contents of input area are not cleared. |
| Search from the restart search window                                 |                                                                                                                                                            |                                                                                                                                                              |
| Search from the top search window (of restart search)                 |                                                                                                                                                            |                                                                                                                                                              |

## Influences of program display lock parameter on edit screen

| Screen operation #1122 pglk_c                                         | 1 (Display: Prohibited, Search: Possible)                                                                                                                      | 2 (Display: Prohibited, Search: Prohibited)                                                                                                                  |
|-----------------------------------------------------------------------|----------------------------------------------------------------------------------------------------------------------------------------------------------------|--------------------------------------------------------------------------------------------------------------------------------------------------------------|
| The file is automatically opened when changing the edit screen (*1)   | The program contents are not displayed. Only "%" is displayed.                                                                                                 | -<br>(It is not possible to search, so the file is never automatically opened when changing the edit screen.)                                                |
| When the file is opened by the menu [Open].                           | The operation message "Program display lock C" appears. The window is not closed. (When the edit lock B or C is valid, edit lock B or C is given to priority.) |                                                                                                                                                              |
| Display when [Program display] highlights on the 2D check full-screen | The program contents are not displayed. Only "%" is displayed.                                                                                                 |                                                                                                                                                              |
| Right side program display when check main menu is selected           |                                                                                                                                                                |                                                                                                                                                              |
| Search from the operation search window of 2D/3D check                | The search can be executed.                                                                                                                                    | The search cannot be executed. The operation message "Program display lock C" appears. The window is not closed. The contents of input area are not cleared. |

(\*1) When changing the edit screen, the file opened immediately before or operation searched/check searched is automatically opened.

### 5.8.5 Data Protection Keys

Data protection key prevents various data from being set or erased.

The key name differs according to the MTB. Refer to the instruction manual issued by the MTB for details.

The following data can be protected with the data protection key:

- All tool data and the coordinate system preset data using the origin set
- User parameters and common variables
- Machining programs
- Files in the memory card
- Files in the DS

The data protection key is enabled to prohibit the setting, erasing, etc. while the PLC signal is OFF (B contact).

Data protection key has higher protection level than that of Data protection by user's level.

## 5.8.6 Leading Zero

**When creating a new machining program**

When the parameter "#8936 Delete leading 0" is set to "1", if a file name consisting only of numerical figures is input, the file is created with "0" at the head of the file name deleted.

However, if the file name is out of the range between 1 and 99999999, the leading "0" is not deleted. This also applies to MTB macros.

In the case of fixed cycles, regardless of the setting of "#8936 Delete leading 0", a file name to create must be 9 digits, and it must not start from "0". Attempting to create a name not following the conditions above will cause an error.

When "#8936 Delete leading 0" is set to "1", if a file name consisting only of numerical figures is input, the leading "0" is deleted when checking whether the file exists or not, and when checking edit lock B/edit lock C.

(Example) For a directory that has a file "1", if a file name "0001" is attempted to be input as a new file, an error will occur.

**Example of deleting of leading zero**

| Input file name | Created file name | Remarks                                                                                 |
|-----------------|-------------------|-----------------------------------------------------------------------------------------|
| 0012345678      | 12345678          | The leading "0"s are deleted                                                            |
| 0123456789      | 0123456789        | As this name is out of the range between 1 and 99999999, the leading "0" is not deleted |
| 0123A           | 0123A             | As a nonnumerical character (alphabet) is included, the leading "0" is not deleted      |
| 0123.PRG        | 0123.PRG          | As a nonnumerical character (extension) is included, the leading "0" is not deleted     |

**When transferring, or comparing files**

In a file transfer with "#8936 Delete leading 0" set to "1", only when the file name of the transfer destination consists only of numerical figures, the leading "0" is deleted when the file is transferred.

However, if the file name is out of the range between 1 and 99999999, the leading "0" is not deleted. This also applies to MTB macros.

In the case of fixed cycles, regardless of the setting of "#8936 Delete leading 0", the name of the file to transfer must be 9 digits, and it must not start from "0". Attempting to transfer a file whose name does not satisfy the conditions above will cause an error.

In a file comparison, even if "#8936 Delete leading 0" is set to "1", when comparing one separate file that contains one program, "0" at the head of the program name is not deleted. Designating the file name is required.

However, in the case of serial/batch file, comparison is carried out with a leading zero in the program name deleted.

■(Example 1) One file has one program

- (1) The files are transferred from the USB memory to the memory.

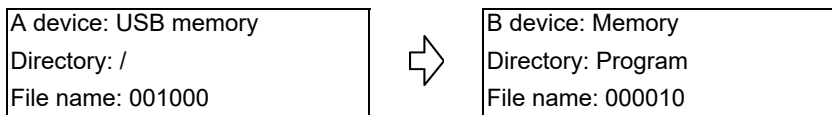

The files are transferred to the memory as follows.

The leading zero is deleted from the file name.

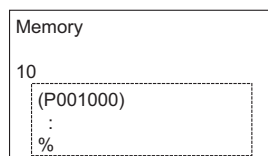

- (2) In order to carry out comparison, change the file name of the transfer destination to "10".  
 (In a comparison of one separate file that has one program, as "0" at the head of the program name is not deleted, if the file name remains "000010", it will be compared with the file "000010" of the transfer destination.)

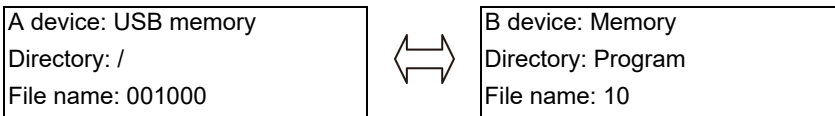

■(Example 2) Serial/Batch file

- (1) The serial of the transfer destination has files as below.

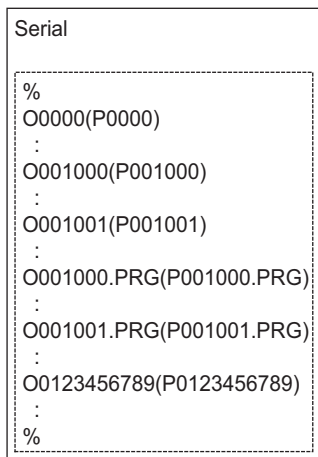

- (2) The files are transferred from the serial to memory.

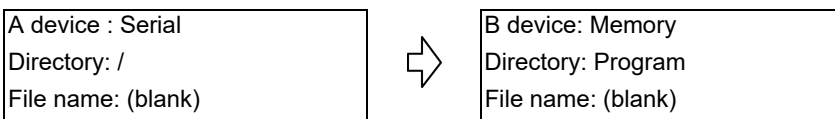

The files are transferred to the memory as follows.

- ◆Files whose leading zeros are deleted: 001000, 001001
- ◆Files whose leading zeros are not deleted as the names are out of the range between 1 and 99999999: 0000, 0123456789
- ◆Files whose leading zeros are not deleted as the names contain nonnumerical characters: 001000.PRG, 001001.PRG

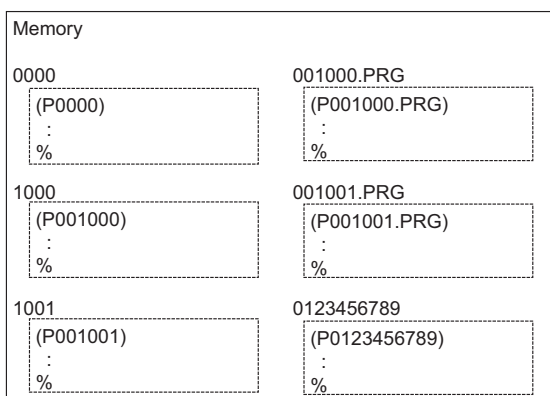

- (3) Comparison is carried out. (As the serial/batch files are compared with the leading zeros deleted, changing file names is not required.)

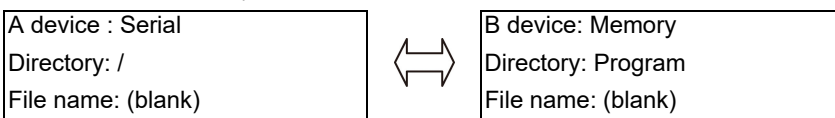

## 5.9 The Batch Input/Output the Machining Program of NC Memory



On the I/O screen of the edit (Edit) screen, one file which consists of two or more machining programs can be transferred to NC memory by dividing the file. The machining programs united with one file can be transferred to the external device. The targets are the machining programs of the user.

The target external devices are HD, memory card, DS, Ethernet, serial and USB memory.

### Batch input and verify to NC memory

Example of "the external device -> NC memory" of machining program batch transfer

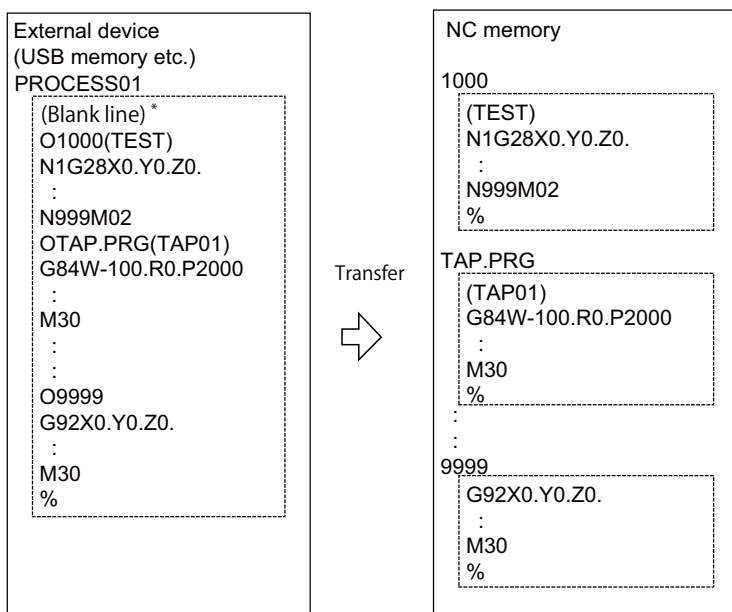



When the external device is serial, the top line is %.

When the transfer direction file name is designated, the top program name of transfer source can be omitted ("O1000" can be omitted in above example).

Comment is not added after a program name when a program is output to an external device, however, if there is comment after a program name when a program is input, the comment is input to the head of the first part system.

- (1) Use the [←] or [[←] key to select file setting column A on the I/O screen of the edit screen.
- (2) Designate the transfer source device and directory.
- (3) Designate the file which consists of two or more machining programs.
- (4) Use the [→] or [→] key to select file setting column B.
- (5) Designate the transfer direction device (memory).

- (6) Press the menu [Program all].  
When the file name is designated, only the top program of transfer source is stored in the designated file. For example of "Example of "the external device -> NC memory" of machining program batch transfer", when "TESTCUT" is designated as the transfer direction file name, the top program is transferred as not "1000" but "TESTCUT".
  
- (7) Press the menu [Trnsfr A→B].
  
- (8) Press the [Y] or [INPUT] key.  
When the same machining program already exists in transfer direction device, the operation message "Overwrite this file?(Y/N)" appears. The transferring the following program is continued by selecting [Y] or [N] key.  File transfer is commenced. Transmitting data is displayed in input data display column. The operation message "Transfer complete" appears upon the completion of transmission.
  
- (9) Press the menu [Compare A:B].  The file comparison starts. The verifying data is displayed. A message appears when the comparison is completed. When the verification error occurs, the error block is displayed in verification data display column and the operation message "Compare error. Compare next file?(Y/N)" appears.

**Note**

- (1) When programs are input in a batch to NC memory, always specify "Program batch" to NC memory directory as transfer direction. If "Program batch" is not specified, one file is transferred (No batch).
- (2) When the program which is subject to edit lock exists in transfer source, the message "Edit lock B" or "Edit lock C" appears, and transfer is interrupted. When the program which is not subject to edit lock is transferred, delete the program which is subject to edit lock in transfer source. (Refer to "5.8.3 Edit Lock B and C".)
- (3) When the protection of the machining program is valid, the program cannot be transferred/verified. (Refer to "5.8.5 Data Protection Keys".)
- (4) The program during automatic operation, program restart or program checking cannot be overwritten. The operation message "Executing automatic operation", "Program restarting" or "Program checking" appears, and transfer is interrupted.
- (5) If the transfer destination includes the file being edited on the custom screen, the operation message "Can't write into being edited file" appears and the transfer may be interrupted.
- (6) The first line of the transfer source file is ignored.
- (7) When the transfer source is serial, the file is similarly transferred even if the transfer direction setting is the following case 1 and case 2:

|             | Case 1                     | Case 2                     |
|-------------|----------------------------|----------------------------|
| Device name | Memory                     | Memory                     |
| Directory   | Program batch              | Program                    |
| File name   | (Null or file designation) | (Null or file designation) |

## Batch output and verify from NC memory

Example of "NC memory -> the external device" of machining program batch transfer

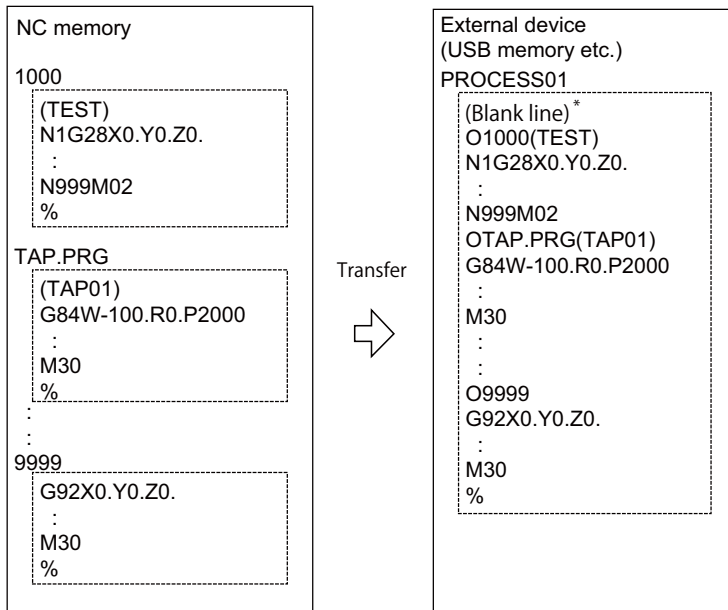

When the external device is serial, the top line is %.

- (1) Use the [←] or [I←] key to select file setting column A on the I/O screen of the edit screen.
- (2) Designate the transfer source device (memory).
- (3) Press the menu [Program all].  
Do not specify the file name. If the name is specified, an error will occur.
- (4) Use the [→] or [I→] key to select file setting column B.
- (5) Designate the transfer direction device and directory.
- (6) Designate the transfer direction file to input multiple machining programs.  
When the file name is not designated, output to the file "ALL.PRG" of the designated directory.
- (7) Press the menu [Trnsfr A→B].
- (8) Press the [Y] or [INPUT] key.  
When the same machining program already exists in transfer direction device, the operation message "Overwrite this file?(Y/N)" appears. The transferring the following program is continued by selecting [Y] or [N] key.



File transfer is commenced. Transmitting data is displayed in input data display column.  
The operation message "Transfer complete" appears upon the completion of transmission.

- (9) Press the menu [Compare A:B].



The file comparison starts. The verifying data is displayed. A message appears when the comparison is completed. When the verification error occurs, the error block is displayed in verification data display column and the operation message "Compare error. Compare next file?(Y/N)" appears.

### Note

- (1) When programs are output in a batch from NC memory, always specify "Program batch" to NC memory directory as transfer source. If "Program batch" is not specified, the program is transferred by one program per one file.
- (2) When the programs which are subject to edit lock exists in NC memory, those file is not transferred. (The files are transferred excluding those files.) The verification is executed excluding the programs which are subject to edit lock. (Refer to "5.8.3 Edit Lock B and C".)
- (3) When the protection of the machining program is valid, the program cannot be transferred/verified. (Refer to "5.8.5 Data Protection Keys".)
- (4) When the transfer direction is serial, the program is similarly transferred even if source of following case 1 and case 2 is set.

|             | Case 1        | Case 2       |
|-------------|---------------|--------------|
| Device name | Memory        | Memory       |
| Directory   | Program batch | Program      |
| File name   | (Null)        | * (Wildcard) |

### Precautions

- (1) When the machining program batch input/output function of NC memory is used, "(" cannot be used for the machining program name. It is recognized that the inside of "(" is a comment.
- (2) The file name of file which consists of two or more machining program can have up to 32 characters, including the extension as well as the machining program.
- (3) When the "Program batch" is designated to NC memory directory, it is not possible to delete, rename and merge files. When the files are deleted in a batch, use "Program" for directory, and a wildcard (\*) for file name.
- (4) When you use the all-program batch input/output function for the NC memory, the programs except for those protected are output. If the NC memory contains any protected program, the operation message "Transfer complete. Some file not output" appears.
- (5) For other precautions, refer to "5.3 Transferring a File".



## 5.10 Formatting Memory Card/DS/USB Memory

This section explains how to format the memory card (front-side SD card), DS (built-in SD card) and USB memory.

(Example) Formatting memory card

(1) Press the menu [MemCrd format].



The message confirming the format "OK?(Y/N)" appears.

(2) Press the [Y] or [INPUT] key.



The memory card is formatted.  
During format, the message "Executing format" appears and the message "Format complete" appears when the format is completed.

When formatting DS or USB memory, press the menu [DS format] or [USB Memformat] in the procedure (1).

### **Note**

- (1) When the capacity of memory card, DS and USB card are less than 2GB, the format is executed with FAT16, and when their capacity are 2GB to 32GB, format is executed with FAT32.  
When formatting the memory card, DS or USB memory whose capacity exceeds 32GB, the message "Format error" appears and the format cannot be executed.
- (2) The format cannot be executed during automatic operation.

## Setting a Tool and a Workpiece

This chapter explains the details of tools and workpieces based on respective menus on the setup (Setup) screen.

### 6.1 Setting a Tool

Refer to the instruction manual issued by the MTB for details on the tool setting.

### 6.2 Registering a Tool (Tool Registration Screen)



A tool No. is assigned to each tool to make the tools installed on the machine recognizable to the NC on the tool registration (T-reg) screen of the Setup screen. The tool No. is registered corresponding to the magazine pot and spindle where that tool is installed, and the standby location.

When the tool No. and magazine pot are changed by a tool selection command or tool replacement command, the new tool No. is displayed.

When not making an arbitrary setting for the number of registered tools, there are maximum 3 magazines, and up to 120 tools can be registered for each magazines. When making an arbitrary setting, there are a maximum of 5 magazines, and up to 360 tools can be registered for all magazines.

This function differs depending on the specifications of the MTB. Refer to the instruction manual issued by the MTB for details.

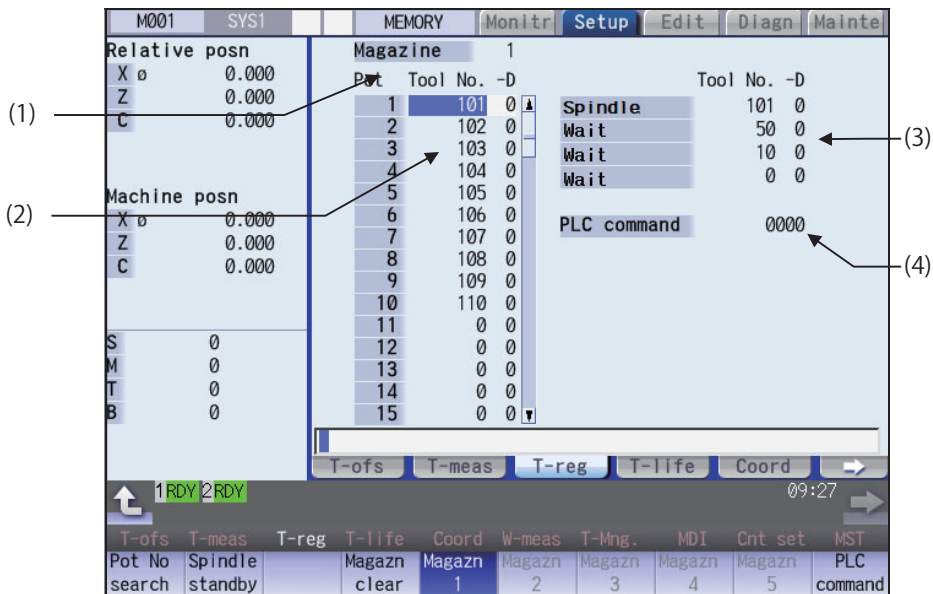

Manual numerical value command can be executed when manual numerical value command window is displayed by inputting an address key such as MST, etc.

| Display items                             |                                                                                                                                                                                                                                                                                                                                                                                                                                                                                                                                                              |
|-------------------------------------------|--------------------------------------------------------------------------------------------------------------------------------------------------------------------------------------------------------------------------------------------------------------------------------------------------------------------------------------------------------------------------------------------------------------------------------------------------------------------------------------------------------------------------------------------------------------|
| Display items                             | Details                                                                                                                                                                                                                                                                                                                                                                                                                                                                                                                                                      |
| (1) Magazine                              | This displays the currently selected magazine No.                                                                                                                                                                                                                                                                                                                                                                                                                                                                                                            |
| (2) Tool No.-D                            | A maximum of 8 digits of data can be input for a tool No.<br>(Refer to the manual issued by the MTB for details on the "D" functions and purposes.)<br>When the "Tool No." column is blank, confirm the tool first, since the tool could not be mounted, or the tool could not match the spindle.<br>Setting "0" erases the registered tool.                                                                                                                                                                                                                 |
| (3) Spindle/Wait<br>(used by PLC program) | This displays spindle or standby tool No.<br>(The name of this area differs depending on the output from the PLC program.)<br>Spindle/standby display for each magazine varies depending on the setting of the parameter "#11054 Sp-stby disp type".<br><Note><br>♦Spindle/standby tool display varies depending on the setting of the ATC control parameter (R10600).<br>(1) Spindle tool only<br>(2) Spindle tool, Standby 1<br>(3) Spindle tool, Standby 1 to 2<br>(4) Spindle tool, Standby 1 to 3<br>(5) Spindle tool, Standby 1 to 4<br>(6) No display |
| (4) PLC command                           | This command is used to input data and perform sequence processing using the PLC program.                                                                                                                                                                                                                                                                                                                                                                                                                                                                    |

(1) Spindle tool only

|             | Tool No. | -D |
|-------------|----------|----|
| Spindle     | 101      | 0  |
| PLC command | 1234     |    |

(2) Spindle tool, Standby 1

|             | Tool No. | -D |
|-------------|----------|----|
| Spindle     | 101      | 0  |
| Stanby1     | 50       | 0  |
| PLC command | 1234     |    |

(3) Spindle tool, Standby 1 to 2

|             | Tool No. | -D |
|-------------|----------|----|
| Spindle     | 101      | 0  |
| Stanby1     | 50       | 0  |
| Stanby2     | 10       | 0  |
| PLC command | 1234     |    |

(4) Spindle tool, Standby 1 to 3

|             | Tool No. | -D |
|-------------|----------|----|
| Spindle     | 101      | 0  |
| Stanby1     | 50       | 0  |
| Stanby2     | 10       | 0  |
| Stanby3     | 0        | 0  |
| PLC command | 1234     |    |

(5) Spindle tool, Standby 1 to 4

|             | Tool No. | -D |
|-------------|----------|----|
| Spindle     | 101      | 0  |
| Stanby1     | 50       | 0  |
| Stanby2     | 10       | 0  |
| Stanby3     | 0        | 0  |
| Stanby4     | 0        | 0  |
| PLC command | 1234     |    |

(6) No display

|             | Tool No. | -D |
|-------------|----------|----|
| PLC command | 1234     |    |

## Menus

| Menus                     | Details                                                                                                                                                                                                                                              |
|---------------------------|------------------------------------------------------------------------------------------------------------------------------------------------------------------------------------------------------------------------------------------------------|
| Pot No search             | Magazines are displayed sequentially with the selected pot number on the top of them. The cursor moves to the data of the configured pot number, and tool number can be entered.                                                                     |
| Spindle standby           | This sets or erases the tool No. of spindle and standby tools. The cursor will move to the top tool No. of the spindle and standby tools and the setting mode will be entered.                                                                       |
| Magazn clear              | This erases all the currently selected magazine tool data (tool number and D).<br><Note><br><ul style="list-style-type: none"> <li>♦Unselected magazine tool data is not erased.</li> <li>♦The spindle and standby data cannot be erased.</li> </ul> |
| Magazn 1<br>:<br>Magazn 5 | This designates the magazine No. to be displayed on the screen. The displayed menu differs according to the machine specifications. For example, when there are two magazines, only the menus [Magazine 1] and [Magazine 2] display.                 |
| PLC command               | The cursor moves to the PLC command setting area and the mode changes to the setting mode.                                                                                                                                                           |

## Tool registration duplication check

When the tool No. is set to the magazine pot and the spindle/standby, tool registration duplication can be checked. Either of "Executing the duplication check for all valid magazines", "The duplication check invalid" or "Executing the duplication check only in the selected magazine" can be selected by the parameter "#8922 T-reg-dup check".

## &lt;Priority of duplication check&gt;

| Operation                                                                                                     | Setting of the operation parameter "#8922 T-reg-dup check" |                                        |                                                                  |
|---------------------------------------------------------------------------------------------------------------|------------------------------------------------------------|----------------------------------------|------------------------------------------------------------------|
|                                                                                                               | 0: Executing the duplication check for all valid magazines | 1: The duplication check invalid       | 2: Executing the duplication check only in the selected magazine |
| Register tool to magazine pot (Refer to "6.2.1 Registering a Tool in the Magazine Pot".)                      | 1. Magazine n (n =1,2...)<br>2. Spindle/standby            | The duplication check is not executed. | 1. Selected magazine<br>2. Spindle/standby                       |
| Set tool No. to spindle/standby (Refer to "6.2.3 Setting and Erasing the Tool No. of Spindle/Standby Tools".) | 1. Spindle/standby<br>2. Magazine n (n =1,2...)            | The duplication check is not executed. | 1. Spindle/standby<br>2. Selected magazine                       |

When the value of the parameter "#8922 T-reg-dup check" is out of the range, the check of setting "0" is performed (Executing the duplication check for all valid magazines).

## 6.2.1 Registering a Tool in the Magazine Pot

**Operation method (Selecting a magazine No.)**

- (1) Press the menu [Magazn 2].  The tool data of the set magazine No. appears.

**Note**

- (1) The No. of magazines differs according to the machine specification.

**Operation method (Registering the tool in the magazine pot)**





- (1) Designate the pot No.  
[Pot No search] 21 [INPUT]
- (2) Input the tool number.  
50 [INPUT]
- When the [INPUT] key is pressed without setting a value, the tool number does not change and the cursor moves to the "tool number" for the next pot number.
-  When the duplication check is valid, the operation message "Exists in magazine 1. Set?(Y/N)" or "Exists in spindle/standby. Set?(Y/N)", etc. appears if the input tool No. already exists invalid magazine, spindle/standby.

**Note**

- (1) Move the cursor with  key to set the "D" data. Refer to the manual issued by the MTB for details on the "D" functions and purposes.
- (2) The duplication check is executed for only the tool No. The check does not depend on the setting of "D".
- (3) If parameter "#8922 T-reg-dup check" is set to "1", the operation message will not appear even when the tool No. duplicates.
- (4) The magazine to be checked varies depending on the setting of the parameter "#8922 T-reg-dup check".

## 6.2.2 Setting the PLC Command

**Operation method (Setting the PLC command)**



- (1) Set the value after the menu [PLC command].  
[PLC command] 12 [INPUT]  The set value displays in the PLC command setting field, and the PLC command setting mode is enabled. The function of the command depends on the MTB specifications.
- (2) Press either the menu [PLC command],  key or   key to complete the setting.  The PLC command setting mode is released, and the menu highlight returns to normal.

**Note**



- (1) Select the menu [PLC Command] again before pressing the [INPUT] key, then the menu highlight returns to normal, and the PLC command setting mode becomes disable.

## 6.2.3 Setting and Erasing the Tool No. of Spindle/Standby Tools

**Operation method (Setting the tool No. of spindle/standby tools)**

- (1) Press the menu [Spindle standby].
- (2) Move the cursor to the data to be set using the [↑], [↓] keys.
- (3) Input a new tool No.  
50 [INPUT]
- (4) Press either the menu [Spindle standby],  key or  The spindle/standby setting mode is canceled.  
 key to complete the setting.

**Note**

- (1) When the menu [Spindle standby],  key or  key is pressed before pressing the [INPUT] key, the spindle/standby setting mode will be canceled and the set data will be ignored.
- (2) Move the cursor with  key to set the "D" data.

**Operation method (Erasing the tool No. of spindle/standby tools)**

- (1) Press the menu [Spindle standby].
- (2) Move the cursor to the tool No. to be erased and input "0".  
0 [INPUT]

**Note**

- (1) Move the cursor with  key and set "0" to erase the "D" data as the same manner as the tool No.

## 6.2.4 Erasing the Tool Registration Data

**Operation method (Selecting a magazine number and erasing the tool registration data.)**

- (1) Press the menu [Magazn 2].
- (2) Press the menu [Magazn clear].
- (3) Press the [Y] or [INPUT] key.  All selected magazine tool data (tool number and D) is erased.  
Spindle/standby tool data is not erased.

### 6.3 Measuring a Tool (Tool Measurement Screen)

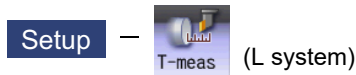

#### 6.3.1 Tool Measurement (M System)

On the tool registration (T-reg) screen of the setup (Setup) screen, the movement distance from the basic point to the measurement point is measured by moving the tool to the measurement point manually, and this value can be set as the tool compensation amount.

Manual numerical value command can be executed when manual numerical value command window is displayed by inputting an address key such as MST, etc.

There are two types of tool measurement: Tool length measurement I, Tool length measurement II.

■ Tool length measurement I

When the tool is at the machine coordinate zero point, the distance from the tool tip to the measurement point (workpiece upper end) is measured, and can be set as tool compensation data.

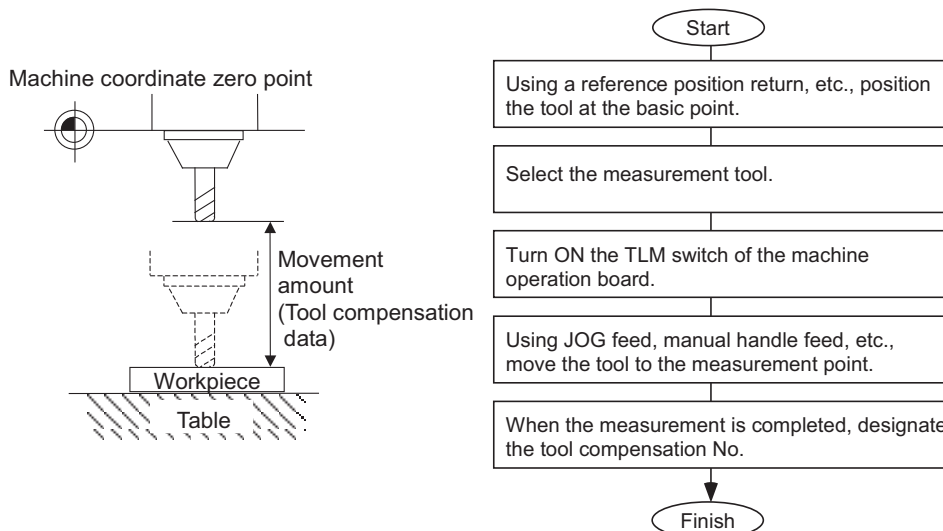



■ Tool length measurement II

When the tool is at the machine coordinate zero point, the distance from the machine coordinate zero point to the tool tip is measured, and can be set as tool compensation data.

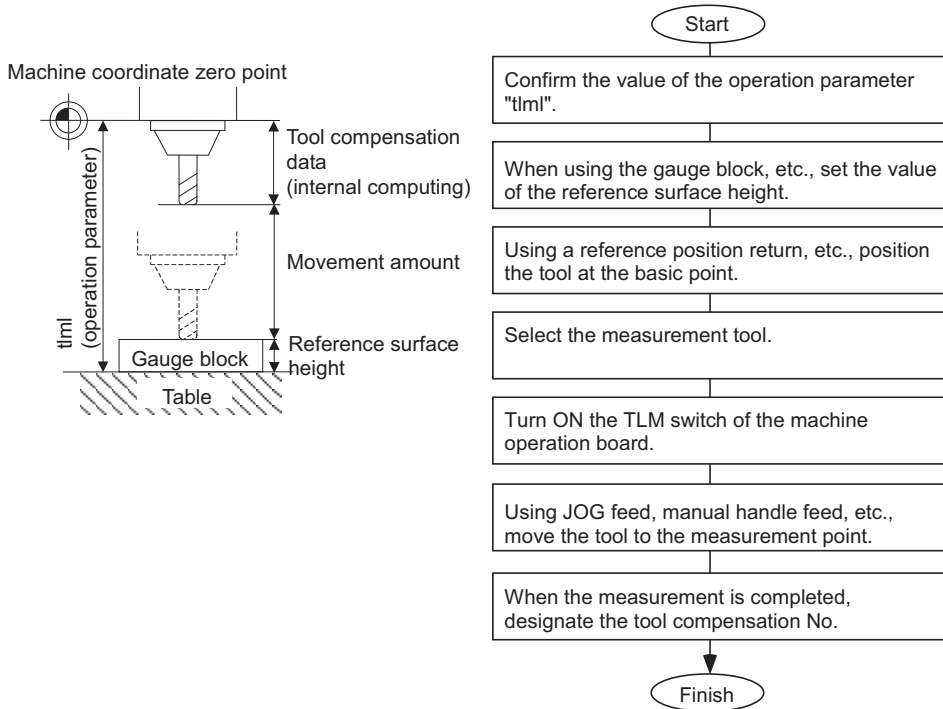

**Note**

(1) The tool measurement type is determined based on TLM reference length (parameter "#2016 t\_lml+" (TLM standard length)) of measurement axes (tool length measurement axis and tool radius measurement axis) at each measurement mode. When parameter "#2016 t\_lml+" (TLM standard length) is set to "0", and "Surface height #0 = 0" is set, the tool measurement type is tool length measurement I.

■ Screen image

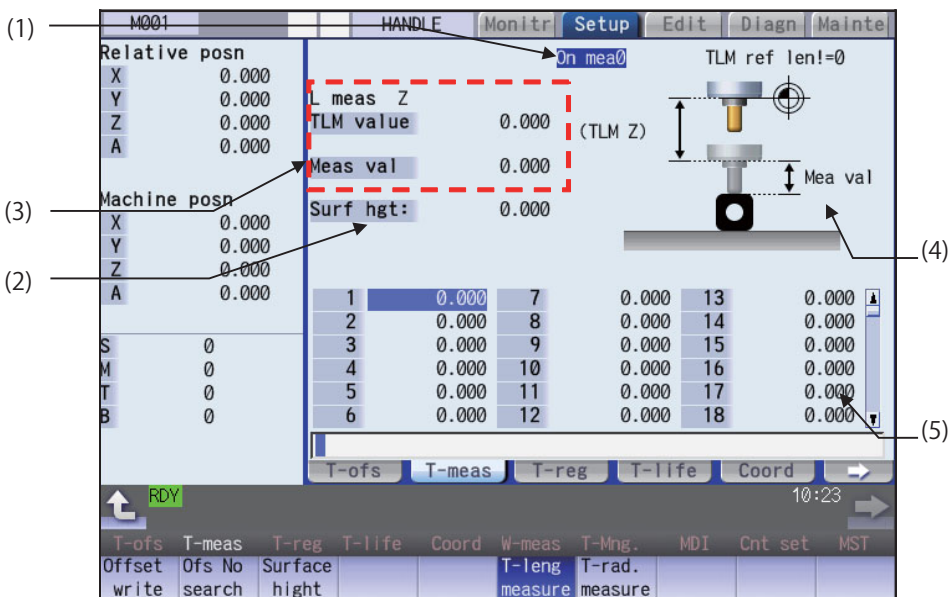

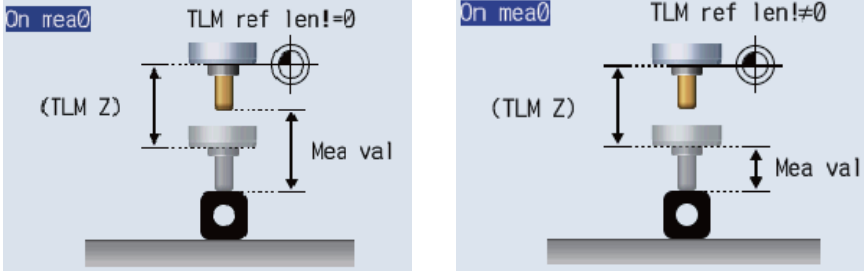
| Display items |                                            |                                                                                                                                                                                                                                                                                                                                                                                                                                                                                                                     |
|---------------|--------------------------------------------|---------------------------------------------------------------------------------------------------------------------------------------------------------------------------------------------------------------------------------------------------------------------------------------------------------------------------------------------------------------------------------------------------------------------------------------------------------------------------------------------------------------------|
| Display items |                                            | Details                                                                                                                                                                                                                                                                                                                                                                                                                                                                                                             |
| (1)           | Manual measurement status display          | This displays the manual measurement status.<br>Refer to "Manual measurement status display" described later in this section.                                                                                                                                                                                                                                                                                                                                                                                       |
| (2)           | Reference surface height                   | This displays a value for the reference surface height.<br>Setting range: -99999.999 to 99999.999 (mm)                                                                                                                                                                                                                                                                                                                                                                                                              |
| (3)           | Counter display                            | TLM value: This displays the value during measurement. (*1)<br>This will be the same as the machine position until the sensor is contacted.<br>This will be the skip coordinate position after the sensor is contacted.<br>Measurement value:<br>For tool length measurement type I: TLM value - Reference surface height<br>For tool length measurement type II: TLM value - Reference surface height + TLM reference length<br>For tool radius measurement, measurement result is displayed in absolute position. |
|               | L meas: (Axis name)<br>R meas: (Axis name) | The axis selected in the parameters "#8711 TLM L meas axis" and "#8712 TLM D meas axis" is the target axis for the measurement.                                                                                                                                                                                                                                                                                                                                                                                     |
| (4)           | Guide graphic                              | Displays the measurement image. The contents of the guide drawing will differ depending on the tool length measurement ( I or II).<br>Tool length measurement I guide drawing Tool length measurement II guide drawing<br>                                                                                                                                                                                                       |
| (5)           | Tool compensation data                     | Displays the tool compensation data. The contents of the tool compensation data to be displayed vary depending on the tool compensation type (I, II, or III).<br>When tool compensation type III is selected, the display is the same as for tool compensation type II.<br>Cursor movement, data input and part system changing operation are same as tool compensation types I and II.                                                                                                                             |

(\*1) The TLM value counter differs according to the parameter "#1328 TLM type" value.

0: The position when the measurement switch was turned ON is displayed as 0.

1: The display is based on the machine zero point.





## Note

(1) If the parameter "#11017 T-ofs set at run" is set to "1", the tool compensation amount data can be measured in the automatic operation mode or operation pause mode.

## Menus

| Menus          | Details                                                                                                                                                                                                                                                                                                                                                                                                                                                                                                                                                                                                                                                                                                     |
|----------------|-------------------------------------------------------------------------------------------------------------------------------------------------------------------------------------------------------------------------------------------------------------------------------------------------------------------------------------------------------------------------------------------------------------------------------------------------------------------------------------------------------------------------------------------------------------------------------------------------------------------------------------------------------------------------------------------------------------|
| Offset write   | This writes the value displayed in "Mea value" as the tool compensation amount.<br>The wear amount is cleared to "0" for the tool compensation type II.<br>The tool compensation amount cannot be written in when the menu [Offset No.] or [Surface hight] is highlighted.<br><Note><br>♦When the parameter "#8924 Meas. confirm msg" is "1", this menu is highlighted and the operation message "OK?(Y/N)" appears. The measurement result is written as tool compensation amount by pressing [Y] or [INPUT] key. Even if other key is pressed, the result is not written. When this menu is pressed again while displaying the message, the highlighting is canceled and the operation message is erased. |
| Ofs No search  | When the compensation No. is set and the [INPUT] key is pressed, the tool compensation data with that number at its head appears.<br>The cursor moves to the length dimension data of the top line of that data.                                                                                                                                                                                                                                                                                                                                                                                                                                                                                            |
| Surface hight  | This sets the reference surface height data. (The cursor moves to the reference surface height.)<br>When the data is set in the input area and the [INPUT] key is pressed, the reference surface height is set.                                                                                                                                                                                                                                                                                                                                                                                                                                                                                             |
| T-leng measure | This changes the mode to the tool length measurement mode. This mode is enabled when turning ON the power.<br>(The cursor moves to the length dimension position for tool compensation type II or III.)                                                                                                                                                                                                                                                                                                                                                                                                                                                                                                     |
| T-rad. measure | This changes the mode to the tool radius measurement mode. (The tool measurement type is valid only for tool length measurement II.)<br>(The cursor moves to the radius dimension position for tool compensation type II or III.)                                                                                                                                                                                                                                                                                                                                                                                                                                                                           |

## Carrying out tool length measurement

- (1) Turn ON the measurement switch.  
Refer to the PLC Interface Manual for details on measurement switch signals.  The message "On mea 0" appears.
- (2) Press the menu [T-leng measure].  The menu is highlighted, and the tool length measurement starts. The measurement values are displayed in "Meas value" during the measurement.  
The menu [T-leng measure] is highlighted as a default after the power is turned ON.
- (3) Contact the measurement tool against the sensor, using manual feed and manual handle feed. Stop the feed when the tool contacts the sensor.  When the measurement tool contacts the sensor, the skip position displayed in the measurement values counter.
- (4) The cursor moves to the compensation No. that sets the measurement results.  
(Example) [Ofs No search] 12 [INPUT]  
The cursor display position differs depending on the measurement mode.  
Tool length measurement mode: Length dimension  
Tool radius measurement mode: Radius dimension
- (5) Press the menu [Offset write].  The measurement values are written as a tool compensation amount.  
The wear amount is cleared to "0" for the tool compensation type II.
- (6) Turn OFF the measurement switch to finish measuring.

**Note**

- (1) The measurement values are not written if the cursor is in a position other than "Length" or "Radius".
- (2) The axis returns and stops after contacting the sensor, but be careful not to move the axis after that. If the axis moves after contacting the sensor, the distance that was actually moved will be added to the measurement values counter, and the skip position will not be held.

**Manual measurement status display**

The display will change as shown below during manual measurement.

| Display  | Meaning                                                                                                                                                                                                                                                              |
|----------|----------------------------------------------------------------------------------------------------------------------------------------------------------------------------------------------------------------------------------------------------------------------|
| On mea 1 | This state is entered if a skip signal is input during manual measurement.<br>The "On mea 2" state is shifted to after deceleration stop is confirmed.                                                                                                               |
| On mea 2 | This is the state during the first retract operation.<br>The "On mea 3" state is shifted to after retracting the retract amount.                                                                                                                                     |
| On mea 3 | This is the state in which retract by the retract amount has completed.<br>If the skip after deceleration stop confirmation signal is ON, the status display will remain the same.<br>The "On mea 0" state is shifted to when this state is reset.                   |
| On mea 4 | This is the state during the second measurement.<br>If the skip signal is not input even after moving to the specified position, a warning will appear, and the status display will remain the same.<br>The "On mea 0" state is shifted to when this state is reset. |
| On mea 5 | This state is entered when the skip signal is input during the second measurement.<br>The "On mea 6" state is shifted to after deceleration stop is confirmed.                                                                                                       |
| On mea 6 | This is the state during the second return operation.<br>The "On mea 0" state is shifted to after retracting the retract amount.                                                                                                                                     |
| On mea 0 | This state is entered when not in the "On mea 1" to "On mea 6" states.                                                                                                                                                                                               |

**Carrying out tool radius measurement**

The operating procedure of the tool radius measurement and submenu details are the same as when measuring tool length. (Use [T-rad. measure] instead of [T-leng measure].)

6.3.2 Tool Measurement (L System)

Manual tool length measurement I or II can be performed on the tool registration (T-reg) screen of the setup (Setup) screen. Either one is selected depending on the setting of measurement switch and operation mode.

Manual numerical value command can be executed when manual numerical value command window is displayed by inputting an address key such as MST, etc.

There are two types of key operation for Manual tool length measurement I: normal operation mode and simple operation mode, which can be selected by the parameter "#8957 T meas (L)-Simple".

| #8957 | Manual tool length measurement I operation mode |
|-------|-------------------------------------------------|
| 0     | Normal operation mode                           |
| 1     | Simple operation mode                           |

■Manual tool length measurement I (when measurement switch is ON)

There are three methods for manual tool length measurement I, and the values to set for the measurement basic point will differ. Set the measurement method by the parameter "#11087 Meas basic point".

| #11087 | Method                                                | Measurement basic point             |
|--------|-------------------------------------------------------|-------------------------------------|
| 0      | Machine zero point designation method                 | Machine coordinate zero point       |
| 1      | Parameter designation method                          | The coordinates set by "#2015 tml-" |
| 2      | Workpiece coordinate system offset designation method | Workpiece coordinate offset (modal) |

<Machine zero point designation method (#11087 = 0)>

In this method, the machine coordinate system zero point is the measurement point.

Move the tool to the face or side, and calculate the tool compensation amount from the measurement position (machine position) and program zero point offset (L).

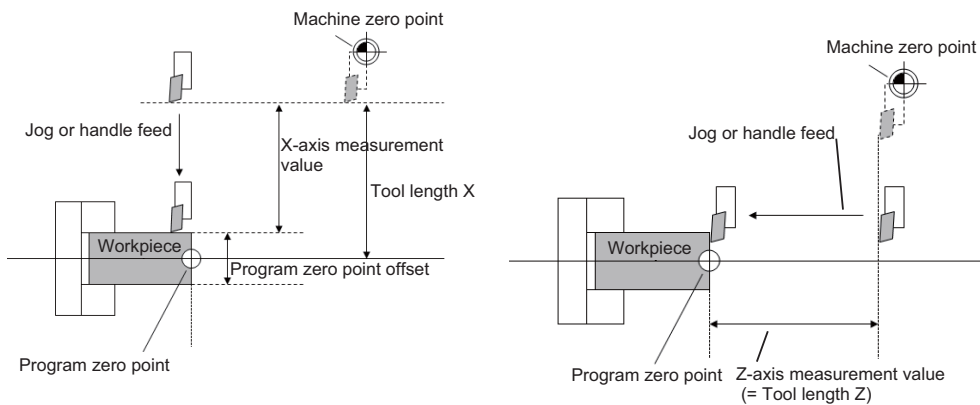

The tool length is automatically calculated by the following formula:  
 Tool length = Measurement position - Program zero point offset (L)

**Note**

- (1) For the program zero point offset (L), set the diameter value for a diameter axis (#1019 dia = 1) or the radius value for a radius axis (#1019 dia = 0).

<Parameter designation method (#11087 = 1)>

In this method, the offset from the machine coordinate system zero point set in "#2015 tlm-" is treated as the measurement basic point.

Move the tool to the face or side, and calculate the tool compensation amount from the measurement position (machine position - measurement zero point (#2015 tlm-)) and program zero point offset (L).

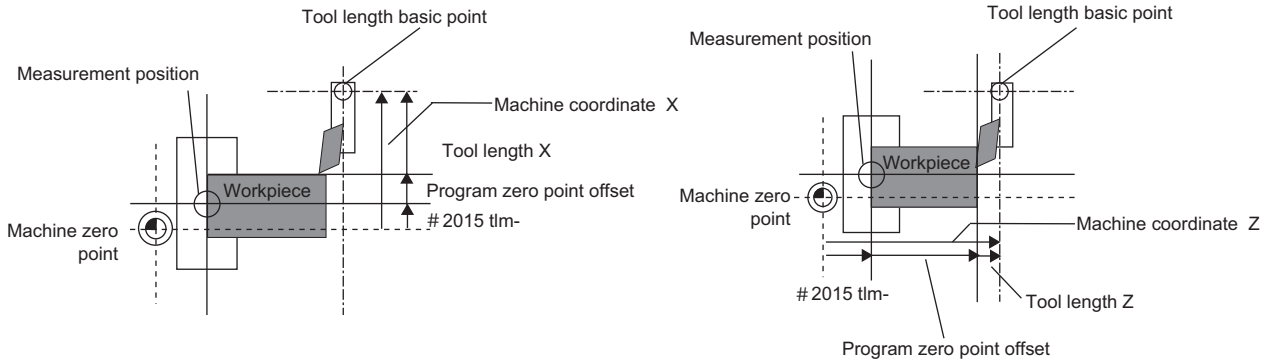

The tool length is automatically calculated by the following formula:

Tool length = Measurement position (machine coordinate value - measurement zero point (#2015 tlm-)) - Program zero point offset (L)

**Note**

- (1) The measurement zero point is always the radius value regardless of the diameter/radius command.
- (2) For the program zero point offset (L), set the diameter value for a diameter axis (#1019 dia = 1) or the radius value for a radius axis (#1019 dia = 0).

<Workpiece coordinate system offset method (#11087 = 2)>

In this method, the workpiece coordinate system offset (modal) is treated as the measurement basic point.

Move the tool to the face or side, and calculate the tool compensation amount from the measurement position (workpiece coordinate position) and program zero point offset (L).

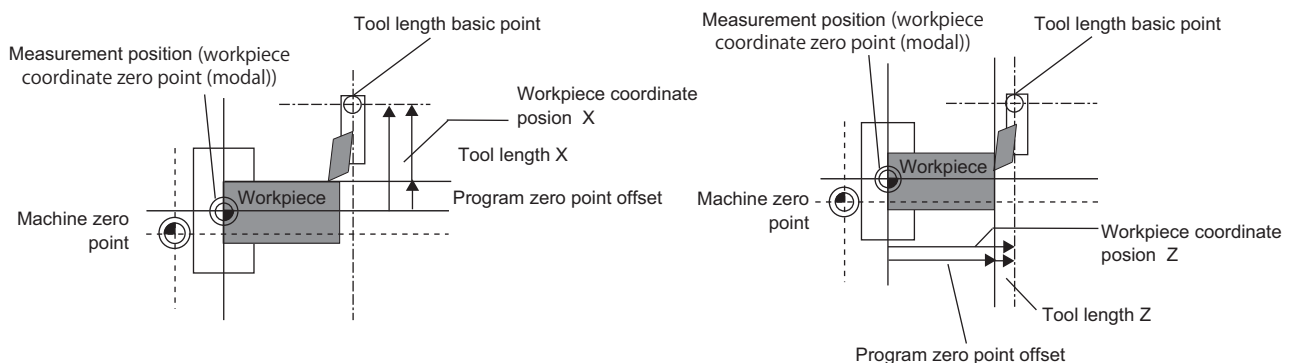

The tool length is automatically calculated by the following formula:

Tool length = Measurement position (workpiece coordinate position) - Program zero point offset (L)

**Note**

- (1) For the program zero point offset (L), set the diameter value for a diameter axis (#1019 dia = 1) or the radius value for a radius axis (#1019 dia = 0).

■Manual tool length measurement II

<When operation mode is set to a handle mode ("JOG", "HANDLE", "RAPID" or "STEP") while the measurement switch is being ON>

By using a device having a touch probe, the tool compensation amount can be calculated just by contacting the tool nose against the touch probe with manual feed.

Set the measurement basic position (sensor position) with the parameter "#2015 tml-" and "#2016 tml+" when using the main spindle side, "#2097 tml-" and "#2098 tml+" when using the sub spindle side.

[Setting the measurement basic position]

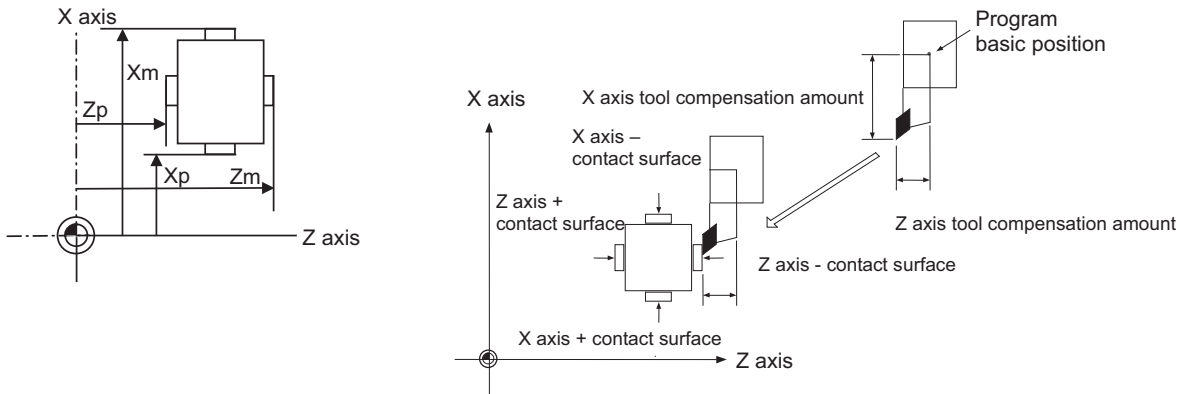

When measured at the main spindle side:

- Xm: - sensor machine coordinate position X axis (position measured by moving in - direction) -> #2015 tml- X axis
- Zm: - sensor machine coordinate position Z axis (position measured by moving in - direction) -> #2015 tml- Z axis
- Xp: + sensor machine coordinate position X axis (position measured by moving in + direction) -> #2016 tml+ X axis
- Zp: + sensor machine coordinate position Z axis (position measured by moving in + direction) -> #2016 tml+ Z axis

When measured at the sub spindle side:

- Xm: - sensor machine coordinate position X axis (position measured by moving in - direction) -> #2097 tml2- X axis
- Zm: - sensor machine coordinate position Z axis (position measured by moving in - direction) -> #2097 tml2- Z axis
- Xp: + sensor machine coordinate position X axis (position measured by moving in + direction) -> #2098 tml2+ X axis
- Zp: + sensor machine coordinate position Z axis (position measured by moving in + direction) -> #2098 tml2+ Z axis

Tool compensation amount = Machine coordinate position (machine coordinate position at the time of skip input) - Measurement basic position (sensor position)

The expression above is used for automatic calculation in Manual tool length measurement II.

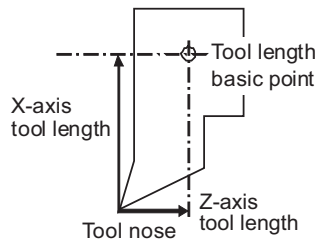

When the tool touches the touch probe while measurement switch is ON, the calculation result is set in the tool data of the compensation No. specified with "Tool No. (Tool length measurement 2)" (PLC device), and the wear data of the compensation No. set in "Wear compensation No. (Tool presetter)" (PLC device) is cleared.

**Note**

- (1) The compensation No. cannot be selected by using [ $\uparrow$ ], [ $\downarrow$ ] or page changeover keys while the measurement switch is being ON. Operations such as selecting an axis, and moving cursor to the wear data or the tool length data, are available by using said keys.

When measuring the tool length of the basic axis and inclined axis during the inclined axis control, the measurement basic position (sensor position) is set on the sensor position within the orthogonal coordinate, not the position within the machine coordinate.

(Example) When X axis is the basic axis and Y axis is the inclined axis.

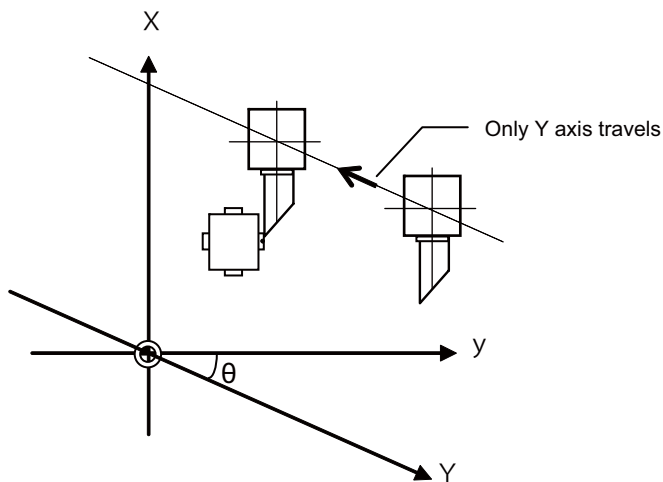

X: Actual X axis  
Y: Actual Y axis  
y: Orthogonal coordinate  
 $\theta$ : Inclined angle



■ Screen image

[Manual tool length measurement I]

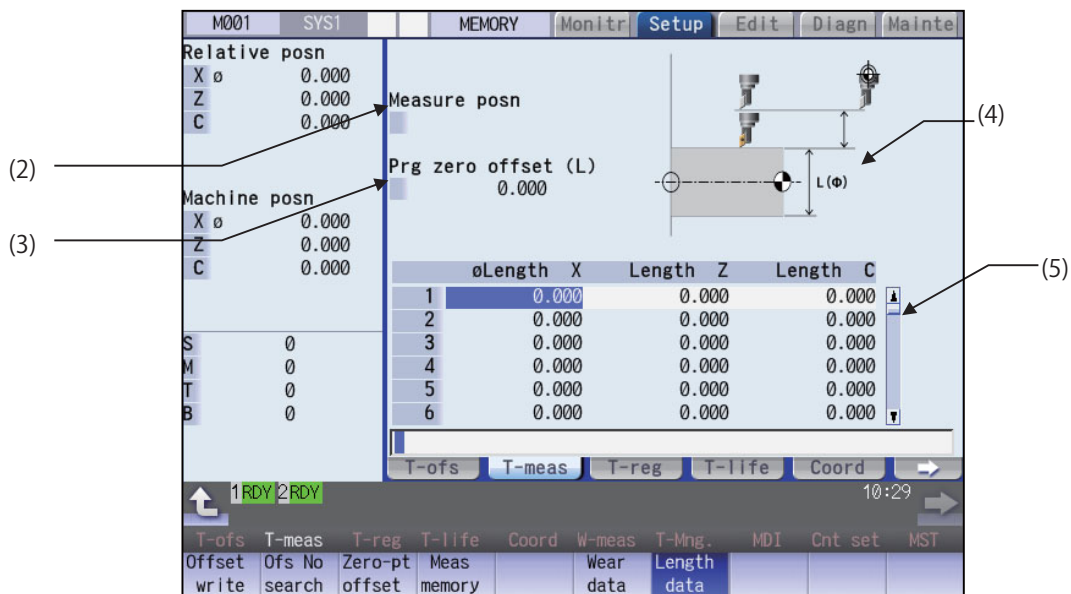

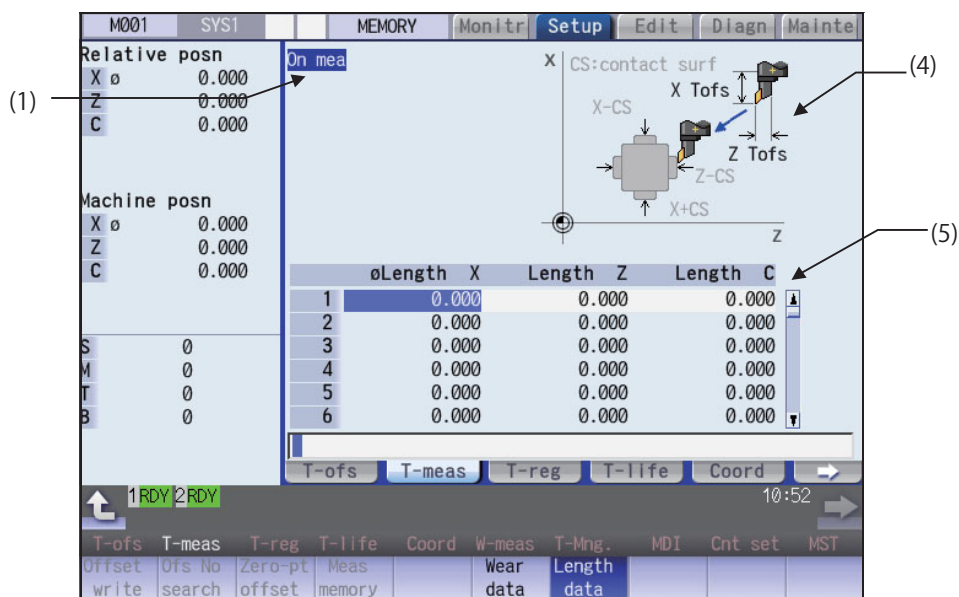

[Manual tool length measurement II]

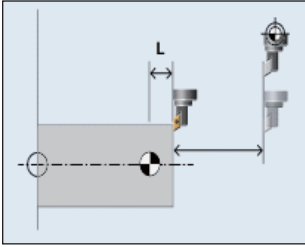
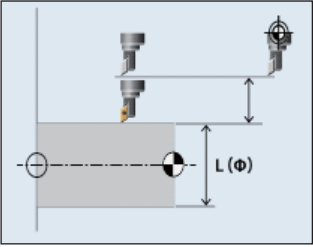
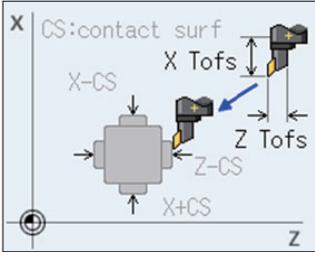

## Display items

| Display items           | Details                                                                                                                                                                                                                                                                                                                                                                                                                                                                                                                                                                                                                                                                                                                                                                                                                                                                                                                                                                                    |
|-------------------------|--------------------------------------------------------------------------------------------------------------------------------------------------------------------------------------------------------------------------------------------------------------------------------------------------------------------------------------------------------------------------------------------------------------------------------------------------------------------------------------------------------------------------------------------------------------------------------------------------------------------------------------------------------------------------------------------------------------------------------------------------------------------------------------------------------------------------------------------------------------------------------------------------------------------------------------------------------------------------------------------|
| (1) On mea              | <p>"On mea" is displayed when the measurement switch is ON.</p> <p>&lt;Note&gt;</p> <ul style="list-style-type: none"> <li>♦This is displayed only in "Manual tool length measurement II".</li> </ul>                                                                                                                                                                                                                                                                                                                                                                                                                                                                                                                                                                                                                                                                                                                                                                                      |
| (2) Measure posn        | <p>When "Manual tool length measurement I" is performed, the measurement result and measurement axis are displayed.</p> <p>&lt;Normal operation mode&gt;</p> <p>Measurement result is displayed by pressing the menu [Meas memory] when the cursor is placed at the axis to be measured.</p> <p>Measurement Position: Machine position when the menu operation is performed.</p> <p>&lt;Simple operation mode&gt;</p> <p>Measurement result for the axis selected using either the menu [Measure X] or the axis address key.</p> <p>Measurement Position: Machine position when the menu operation or address key operation is performed.</p> <p>&lt;Note&gt;</p> <ul style="list-style-type: none"> <li>♦This is displayed only in "Manual tool length measurement I".</li> <li>♦The data of maximum 3 axes displays when "Manual tool length measurement I (Simple operation mode)" is selected.</li> <li>♦The axis names set in the parameter "#1022 axname2" are displayed.</li> </ul> |
| (3) Prg zero offset (L) | <p>Workpiece measurement result is set and displayed.</p> <p>Setting range: -99999.999 to 99999.999 (mm)</p> <p>&lt;Normal operation mode&gt;</p> <p>Setting is possible by pressing the menu [Zero-ptoffset] or touching the value area of the "Prg zero offset (L)".</p> <p>&lt;Simple operation mode&gt;</p> <p>Select the axis to measure using either the menu [Measure X] or the axis address key. Then the cursor moves to "Prg zero offset (L)", where setting a measured value is enabled.</p> <p>&lt;Note&gt;</p> <ul style="list-style-type: none"> <li>♦The data of maximum 3 axes displays when "Manual tool length measurement I (Simple operation mode)" is selected.</li> </ul>                                                                                                                                                                                                                                                                                            |

| Display items                     | Details                                                                                                                                                                                                                                                                                                                                                                                                                                                                                                                                                                                                                                                                                                                                                                                                                                                                                                                                                                                           |
|-----------------------------------|---------------------------------------------------------------------------------------------------------------------------------------------------------------------------------------------------------------------------------------------------------------------------------------------------------------------------------------------------------------------------------------------------------------------------------------------------------------------------------------------------------------------------------------------------------------------------------------------------------------------------------------------------------------------------------------------------------------------------------------------------------------------------------------------------------------------------------------------------------------------------------------------------------------------------------------------------------------------------------------------------|
| <p>(4) Guide graphic</p>          | <p>Displays the measurement image. The contents of the guide drawing will differ depending on which measurement type (Manual tool length measurement I or II) is selected.</p> <p>&lt;Manual tool length measurement I&gt;</p> <ul style="list-style-type: none"> <li>♦Normal operation mode<br/>The guide drawing is switched to the axis pointed by the cursor in the tool compensation data.</li> <li>♦Simple operation mode<br/>The guide drawing is switched to the selected axis, when the handle mode is selected.</li> </ul> <p>&lt;Z axis&gt;</p>  <p>&lt;Other axes&gt;</p>  <p>&lt;Manual tool measurement II&gt;</p> <p>The guide drawing when using the touch probe is displayed.</p>                                          |
| <p>(5) Tool compensation data</p> | <p>Displays the tool compensation data.</p> <p>&lt;Note&gt;</p> <ul style="list-style-type: none"> <li>♦Cursor movement, data input and part system changing operation are same as "Tool compensation type III (L system)".</li> <li>♦Automatically jumps to the compensation No. registered in "Tool No. (Tool length measurement 2)" (PLC device) during manual tool length measurement II. (Jumps even when the wear data is being displayed.) Note that the [↑], [↓],  and  keys are disabled.</li> <li>♦The screen displays the compensation data of four axes when the parameter "#12103 2nd add T-ofs ON" (2nd additional axis tool offset ON) is valid.</li> <li>♦The tool compensation data of an axis which has been set to "1" (hide) by the parameter "#12117 T-ofs hide axis" is not displayed.</li> </ul> |

**Note**

- (1) The values of "Measure posn" and "Prg zero offset (L)" will be cleared when changing of part systems, screens and measurement modes are carried out.
- (2) When the parameter "#11017 T-ofs set at run" (Tool compensation amount setting during automatic operation enabled) is set to "1", the tool compensation amount data can be set even during automatic operation or operation pause.

## Menus (Manual tool length measurement I (normal operation mode) and manual tool length measurement II)

| Menus          | Details                                                                                                                                                                                                                                                                                                                                                                                                                                                                                                                                                                                                                                                                                                                                                                                                                                                                                                                                                                                                                                                                                                                                                                                                                                                                                                                                                                              |
|----------------|--------------------------------------------------------------------------------------------------------------------------------------------------------------------------------------------------------------------------------------------------------------------------------------------------------------------------------------------------------------------------------------------------------------------------------------------------------------------------------------------------------------------------------------------------------------------------------------------------------------------------------------------------------------------------------------------------------------------------------------------------------------------------------------------------------------------------------------------------------------------------------------------------------------------------------------------------------------------------------------------------------------------------------------------------------------------------------------------------------------------------------------------------------------------------------------------------------------------------------------------------------------------------------------------------------------------------------------------------------------------------------------|
| Offset write   | <p>Depending on the mode, the following value is input as the tool compensation amount at the cursor position, and the wear amount is cleared to "0".</p> <p>Manual tool length measurement I<br/>           Tool compensation amount = "Measure posn" value - "Prg zero offset (L)" value<br/>           The values of "Meas posn" and "Prg zero offset (L)" will be cleared after compensation amount is written in "Manual tool length measurement I".</p> <p>&lt;Note&gt;</p> <ul style="list-style-type: none"> <li>• Tool compensation amount cannot be written in the following cases:               <ul style="list-style-type: none"> <li>- When the menu [Offset No.] and [Zero-ptoffset] are highlighted</li> <li>- When the wear data is being displayed</li> <li>- When the measurement result exceeds the setting range</li> </ul> </li> <li>• If "Manual tool length measurement II", this is grayed out and non-selectable.</li> <li>• When the parameter "#8924 Meas. confirm msg" is "1", this menu is highlighted and the operation message "OK?(Y/N)" appears. The measurement result is written as tool compensation amount by pressing [Y] or [INPUT] key. Even if other key is pressed, the result is not written. When this menu is pressed again while displaying the message, the highlighting is canceled and the operation message is erased.</li> </ul> |
| Ofs No search  | <p>When the compensation No. is set and the [INPUT] key is pressed, the tool compensation data with that number at its head appears.</p> <p>&lt;Note&gt;</p> <ul style="list-style-type: none"> <li>• If the measurement switch is turned ON, this is grayed out and non-selectable.</li> </ul>                                                                                                                                                                                                                                                                                                                                                                                                                                                                                                                                                                                                                                                                                                                                                                                                                                                                                                                                                                                                                                                                                      |
| Zero-pt offset | <p>This sets the "Prg zero offset (L)" value. If this menu is pressed, the cursor moves to the "Prg zero offset (L)" value.</p> <p>Point the cursor to the axis to be set, and set the data in the data setting area. Press the [INPUT] key to set the "Prg zero offset (L)" value.</p> <p>&lt;Note&gt;</p> <ul style="list-style-type: none"> <li>• If any mode other than "Manual tool length measurement I" is selected, this is grayed out and non-selectable.</li> </ul>                                                                                                                                                                                                                                                                                                                                                                                                                                                                                                                                                                                                                                                                                                                                                                                                                                                                                                        |
| Meas memory    | <p>Measurement result is calculated from the current machine position and displayed.</p> <p>&lt;Note&gt;</p> <ul style="list-style-type: none"> <li>• If any mode other than "Manual tool length measurement I" is selected, this is grayed out and non-selectable.</li> </ul>                                                                                                                                                                                                                                                                                                                                                                                                                                                                                                                                                                                                                                                                                                                                                                                                                                                                                                                                                                                                                                                                                                       |
| Wear data      | <p>Wear data is displayed in tool compensation data.</p>                                                                                                                                                                                                                                                                                                                                                                                                                                                                                                                                                                                                                                                                                                                                                                                                                                                                                                                                                                                                                                                                                                                                                                                                                                                                                                                             |
| Length data    | <p>Tool length data is displayed in tool compensation data.<br/>           This is the default mode when the power is initially turned ON.</p>                                                                                                                                                                                                                                                                                                                                                                                                                                                                                                                                                                                                                                                                                                                                                                                                                                                                                                                                                                                                                                                                                                                                                                                                                                       |

**Note**

- (1) The data displayed on the tool offset screen are not linked with the tool offset data on the tool measurement screen. (If the tool measurement screen is opened with tool wear data shown on the tool offset screen, the wear data will not always appear on the tool measurement screen.)

## Menus (Manual tool length measurement I (simple operation mode))

| Menus         | Details                                                                                                                                                                                                                                                                                                                                                                                                                                                                                                                                                                                                                                                                                                                                                                                                                                                                                                                                                                                                                                                                                                                                                                                                                                                                                                                                                                                                                                                                                                                                 |
|---------------|-----------------------------------------------------------------------------------------------------------------------------------------------------------------------------------------------------------------------------------------------------------------------------------------------------------------------------------------------------------------------------------------------------------------------------------------------------------------------------------------------------------------------------------------------------------------------------------------------------------------------------------------------------------------------------------------------------------------------------------------------------------------------------------------------------------------------------------------------------------------------------------------------------------------------------------------------------------------------------------------------------------------------------------------------------------------------------------------------------------------------------------------------------------------------------------------------------------------------------------------------------------------------------------------------------------------------------------------------------------------------------------------------------------------------------------------------------------------------------------------------------------------------------------------|
| Offset write  | <p>The following value is written as the tool compensation amount, and the wear is cleared to "0".</p> <p>Tool compensation amount = "Measure posn" value - "Prg zero offset (L)" value</p> <ul style="list-style-type: none"> <li>◆When the tool offset is written, the "Measure posn" and "Prg zero offset (L)" are cleared. The cursor moves to the tool compensation data.</li> <li>◆The offset cannot be written in the following state. The operation message - "Can't write compensation data" is displayed. <ul style="list-style-type: none"> <li>(a) When the menu [Offset number] is highlighted</li> <li>(b) During wear data display</li> <li>(c) When the measurement axis is not selected</li> </ul> </li> <li>◆If the tool compensation amount is outside the setting range, the offset writing fails. The operation message "Setting error" is displayed.</li> </ul> <p>&lt;Note&gt;</p> <ul style="list-style-type: none"> <li>◆When the parameter "#8924 Meas. confirm msg" is set to "1", the menu "Offset write" is highlighted and confirmation message "OK?(Y/N)" is displayed. When you press the [Y] (or [INPUT]) key, the measurement position is written as the tool compensation amount. When you press any other key, the offset is not written. At this time, menu highlighting is canceled and the operation message is erased.</li> </ul> <p>If you press the menu [Offset Write] again during operation message display, the reverse display is released and the operation message is also erased.</p> |
| Ofs No search | <p>When the compensation No. is set and the [INPUT] key is pressed, the tool compensation data with that number at its head appears.</p> <p>This operation will not change the column where the cursor is placed.</p> <p>If this operation is carried out with the cursor placed at "Prg zero offset (L)", the cursor will remain displayed at "Prg zero offset (L)".</p>                                                                                                                                                                                                                                                                                                                                                                                                                                                                                                                                                                                                                                                                                                                                                                                                                                                                                                                                                                                                                                                                                                                                                               |
| Measure X     | <p>Select the axis to measure. The menu is highlighted when it is selected. Multiple axes can be selected. To cancel, press the menu key again or press [Cancel value]. (*1)</p>                                                                                                                                                                                                                                                                                                                                                                                                                                                                                                                                                                                                                                                                                                                                                                                                                                                                                                                                                                                                                                                                                                                                                                                                                                                                                                                                                        |
| Measure Z     | <p>Select the axis to measure. The menu is highlighted when it is selected. Multiple axes can be selected. To cancel, press the menu key again or press [Cancel value]. (*1)</p>                                                                                                                                                                                                                                                                                                                                                                                                                                                                                                                                                                                                                                                                                                                                                                                                                                                                                                                                                                                                                                                                                                                                                                                                                                                                                                                                                        |
| Measure C     | <p>Select the axis to measure. The menu is highlighted when it is selected. Multiple axes can be selected. To cancel, press the menu key again or press [Cancel value]. (*1)</p>                                                                                                                                                                                                                                                                                                                                                                                                                                                                                                                                                                                                                                                                                                                                                                                                                                                                                                                                                                                                                                                                                                                                                                                                                                                                                                                                                        |
| Wear data     | <p>Wear data is displayed in tool compensation data.</p>                                                                                                                                                                                                                                                                                                                                                                                                                                                                                                                                                                                                                                                                                                                                                                                                                                                                                                                                                                                                                                                                                                                                                                                                                                                                                                                                                                                                                                                                                |
| Length data   | <p>Tool length data is displayed in tool compensation data.</p> <p>This mode is enabled when turning ON the power.</p>                                                                                                                                                                                                                                                                                                                                                                                                                                                                                                                                                                                                                                                                                                                                                                                                                                                                                                                                                                                                                                                                                                                                                                                                                                                                                                                                                                                                                  |
| Cancel value  | <p>This cancels displaying the value of the measurement result and "Prg zero offset (L)". The cursor moves from "Prg zero offset (L)" to the tool compensation data.</p> <p>If any mode other than "Manual tool length measurement I" is selected, this menu will be grayed out and non-selectable.</p>                                                                                                                                                                                                                                                                                                                                                                                                                                                                                                                                                                                                                                                                                                                                                                                                                                                                                                                                                                                                                                                                                                                                                                                                                                 |

(\*1) The axis name to be displayed follows the parameter "#1022 axname2".





### Note

- (1) The data displayed on the tool offset screen are not linked with the tool offset data on the tool measurement screen. (If the tool measurement screen is opened with tool wear data shown on the tool offset screen, the wear data will not always appear on the tool measurement screen.)

## Carrying out tool measurement (Manual tool length measurement I)





## ■ Normal operation mode

(Example) Carrying out tool measurement for compensation No.3, X axis

- (1) Select the tool to be measured with manual numerical value command. (Refer to "9.6 Manual Numerical Value Command" for details.)
- (2) Point the cursor to the position (compensation No. 3, X axis) where the measurement result are to be set.  The cursor is displayed at compensation No.3, X axis.  
<Note>
  - In order to measure a different axis, point the cursor to the axis to be measured and perform the following operations.
  - When the axis to apply the mirror image is to be measured, turn ON the mirror image.
- (3) Move the tool to the side surface of the workpiece. (In the case of Z-axis move the tool to the end surface of the workpiece.)
- (4) The menu [Meas memory] is pressed without retracting the tool.  Save the measurement result. Saved value is displayed in the measurement area.  
<Note>
  - For the axis to which the mirror image is turned ON, the measurement position considering the mirror status is displayed.
- (5) Retract the tool and measure the workpiece. And then press the menu [Zero-ptoffset].  The menu [Zero-ptoffset] is highlighted and the cursor moves to the program zero-point offset (L) value.
- (6) Measure the workpiece and set the offset value from the tool position (side surface of the workpiece) to the program zero-point.  
10 [INPUT]  10 is set for the "Prg zero offset (L)" value. Highlight of the menu [Zero-ptoffset] is canceled and the cursor moves to the tool compensation data.  
<Note>
  - Compensation amount is written in diameter value for diameter command, or in radius value for radius command.
- (7) Press the menu [Offset write].  "Measurement result - workpiece measurement value" is set to compensation No.3, X axis.  
<Note>
  - The values of "Measure posn" and "Prg zero offset (L)" are cleared.

### ■ Simple operation mode



(Example) Carrying out tool measurement for compensation No. 3, X axis

- (1) Select the tool to be measured with manual numerical value command. (Refer to "9.6 Manual Numerical Value Command" for details.)
- (2) Move the cursor to the position to input the measurement result (compensation No.3).  The cursor is displayed at compensation No.3.  
<Note>
  - ♦When the axis to apply the mirror image is to be measured, turn ON the mirror image.
- (3) Move the tool to the side surface of the workpiece. (In the case of Z-axis move the tool to the end surface of the workpiece.)
- (4) Press the address key of the axis to measure or the menu [Measure X], without retracting the tool.  Save the measurement result. The memorized value is displayed at "Prg zero offset (L)", and the cursor moves to "Work meas".  
The operation message "Input program Z-point offset" displays.  
<Note>
  - ♦If multiple axes which have the same first letter of the axis name set by the parameter "#1022 ax-name2" exist, the axis address key treats the first found axis (in the order of 1st axis --> 2nd axis --> additional axis) as the measurement axis.
  - ♦For the axis to which the mirror image is turned ON, the measurement position considering the mirror status is displayed.
- (5) To measure the other axes at the same time, repeat (3) to (4).  Save the measurement value of the selected axis.  
Saved value is displayed in the measurement area. The cursor will not move from the top line.
- (6) Retract the tool and measure the workpiece.
- (7) Measure the workpiece and set the offset value from the tool position (side surface of the workpiece) to the program zero-point.  
(Example) 10 [INPUT]  The value 10 is set in the top line of "Prg zero offset (L)".  
If there are two or more axes to measure, the cursor moves down to the next line.  
<Note>
  - ♦Compensation amount is written in diameter value for diameter command, or in radius value for radius command.
- (8) To set the "Prg zero offset (L)" of the other axes, repeat (7).  The value "5" is set to the 2nd line of "Work meas".  
<Note>
  - ♦Compensation amount is written in diameter value for diameter command, or in radius value for radius command.
- (9) Press the menu [Offset write].  
The result of "Meas val - Prg zero offset (L)" will be set as the compensation amount for X and Z axes of the compensation No.3 (where the cursor is currently positioned).  
<Note>
  - ♦The values of "Measure posn" and "Prg zero offset (L)" are cleared, and the highlighted menus ([Measure X] - [Measure C]) will return to original status.

**Precautions for manual tool measurement I**

- (1) When compensation amount is written for an axis that has not completed zero point return, the operation message "TLM axis not returned to ref. position" will appear.
- (2) When the parameter "#8924 Meas. confirm msg" is set to "1", the menu "Offset write" is highlighted and confirmation message "OK?(Y/N)" is displayed. When you press the [Y] (or [INPUT]) key, the measurement position is written as the tool compensation amount. When you press any other key, the offset is not written. At this time, menu highlighting is canceled and the operation message is erased.
- (3) When the parameter "#1124 ofsfix" is set to "0", the cursor moves to the next offset No. However, when "#1124 ofsfix" is "1", the cursor does not move to the next offset No.
- (4) When the parameter "#11017 T-ofs set at run" (Tool compensation amount setting during automatic operation enabled) is set to "1", the tool compensation amount data can be set even during automatic operation or operation pause.

**Carrying out tool measurement (Manual tool length measurement II)**

- (1) Select the tool to be measured with manual numerical value command. (Refer to "9.6 Manual Numerical Value Command" for details.)
- (2) Set the compensation No. of the compensation data to be set in "Tool No. (Tool length measurement 2)" (PLC device).
- (3) Set the compensation No. of the wear data to be cleared in "wear compensation No. (tool presetter)" (PLC device).
- (4) Turn ON the measurement switch.  "On mea" is displayed.  
Guide drawing for manual tool length measurement II is displayed.  
Tool compensation data is displayed, placing the compensation No. set in "Tool No. (Tool length measurement 2)" (PLC device) at the top.  
<Note>  
♦The row at the cursor position will not be changed.
- (5) Move the additional axis in the minus direction by manual feed and have the tool nose contact with the touch probe.  Measurement value is set for the additional axis of the compensation No. set in "Tool No. (Tool length measurement2)" (PLC device).
- (6) Turn the measurement switch OFF.  "On mea" disappears.

**Note**

- (1) When entering the sensor area, the axis can be moved only in one direction selected from +X, -X, +Z, -Z, (+Y, -Y). If two axes are moved simultaneously, measurement will not be carried out. However the axis movement stops for safety with displaying "TLM axis is illegal".
- (2) If the tool nose is contacting the sensor, the axis can be moved only in the direction moving away from the sensor. Whether or not the tool nose is detached from the sensor can be judged by the following conditions.
  - ♦The sensor signal has been turned OFF for 500 ms or more.
  - ♦The tool nose is moved 100 μm or more after the sensor signal has turned OFF.
 The above conditions are set with parameter "#1227 aux11/bit2" (measures against tool setter chattering).



## 6.4 Setting Tool Compensation Amount (Tool Offset Screen)

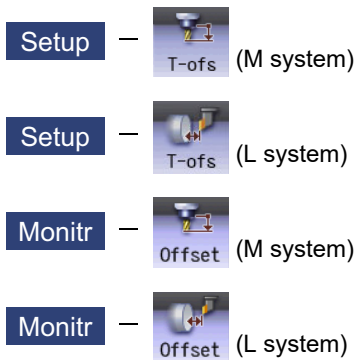

The tool compensation data can be set and displayed tool offset (T-ofs) screen of the setup (Setup) screen.

For M system, three types of tool compensation can be switched by the setting of the parameters "#1037 cmdtyp" and "#1046 T-ofs disp type".

- Tool compensation type I (#1037=1/#1046=0)
- Tool compensation type II (#1037=2/#1046=0)
- Tool compensation type III (#1046=1)

For L system, tool compensation type III is selected regardless of the setting of the parameter #1037/#1046".

The tool radius compensation can be carried out using the diameter value if the parameter "#8117 OFS Diam DESIGN" is set to "1".

The number of tool compensation sets to be designated or displayed varies depending on the additional specifications.

Tool compensation data can be set or displayed on the monitor (Monitr) screen.

### Note

- (1) When the tool compensation amount setting during automatic operation is enabled ("#11017 T-ofs set at run" = "1"), the tool compensation amount data can be set even during automatic operation or operation pause.

**[Tool compensation type I] (M System): Parameter "#1037 cmdtyp" = 1**

The combined amount of the shape compensation and wear compensation are set as the compensation data, with no distinction between shape compensation memory and wear compensation memory. (The tool compensation data is the shape compensation amount + wear compensation amount.)

The compensation data is used commonly for the tool length compensation, tool position offset, tool radius compensation, and 3-dimensional tool radius compensation.

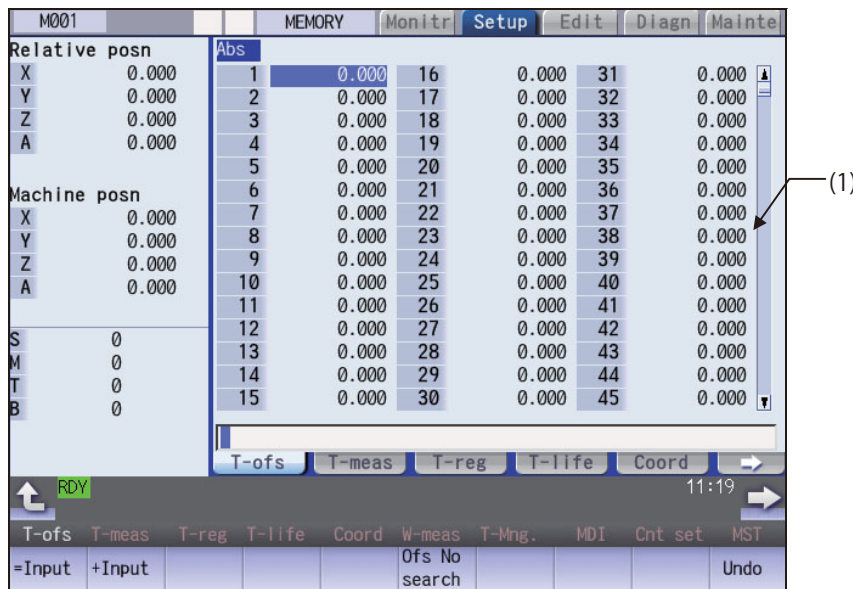

**[Tool compensation type II] (M System): Parameter "#1037 cmdtyp" = 2**

The shape compensation amount and wear compensation amount are set separately. The shape compensation amount is furthermore divided into length and radius dimensions.

Of the compensation data, the length dimension data is used for the tool length compensation and tool position offset, and the radius dimension data is used for the tool radius compensation and 3-dimensional tool radius compensation (compensation vector designation).

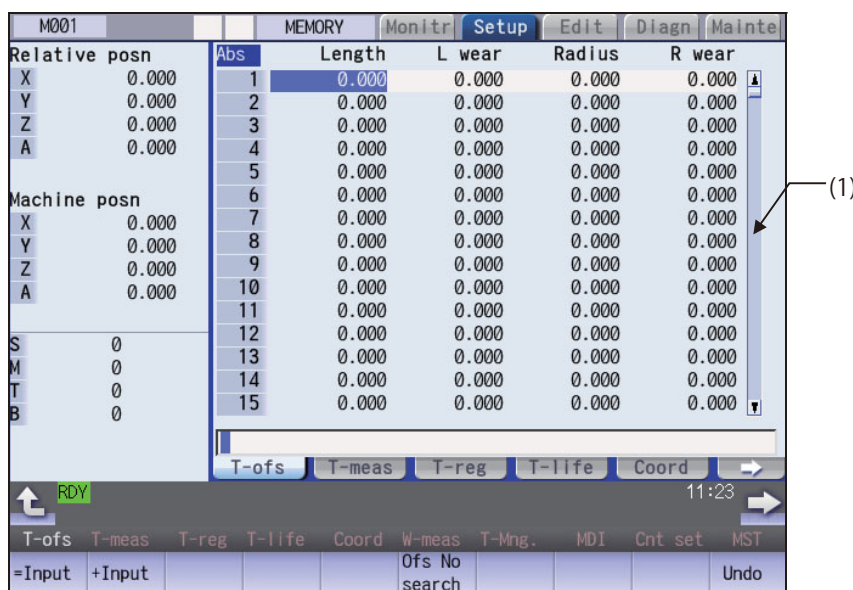

**[Tool compensation type III] (M/L System): Parameter "#1037 cmdtyp" = 3**

This type has 4 kinds of display such as wear data, tool length data, nose data and cutting-edge angle data.

The wear data and the tool length data for four axes can be set and displayed by the parameter setting of "#12103 2nd add T-ofs ON". Specified axis is set not to be set and displayed by the parameter setting of "#12117 T-ofs hide axis."

■Wear data

Set the wear amount of nose for each tool you use.

When a tool compensation number is designated by the tool command (T command), the compensation operation is performed with the tool length data, nose data and cutting-edge angle data.

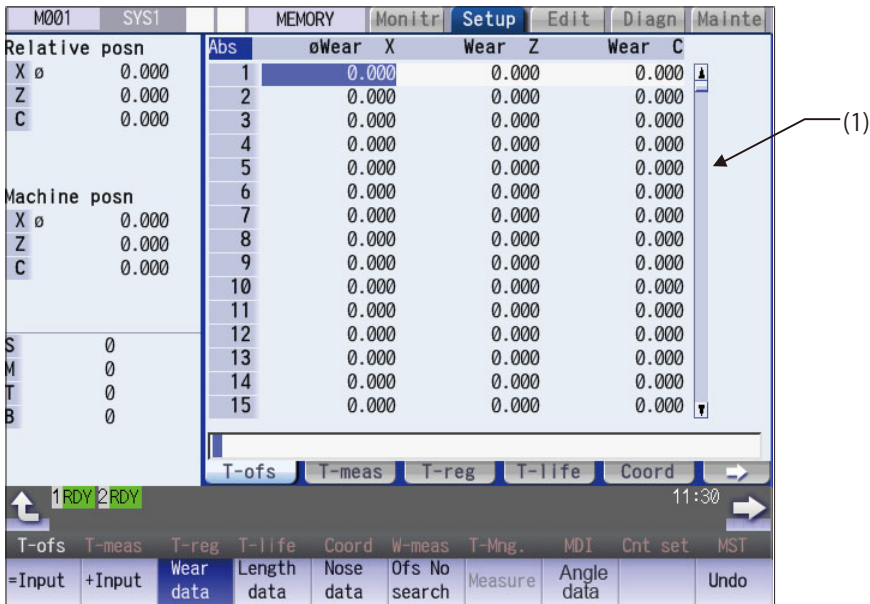

■Tool length data

Set the tool length according to the reference position of program for each tool used.

When a tool compensation number is designated by the tool command (T command), the wear data is offset together with the wear data, nose data and cutting-edge angle data.



■Nose data

Set the radius (Nose R), wear radius (R-wear), and point (Point) of the nose that is mounted on the tool for each tool used.

When a tool compensation number is designated by the tool command (T command), the compensation operation is performed with the tool length data, wear data and cutting-edge angle data.



■Cutting-edge angle data



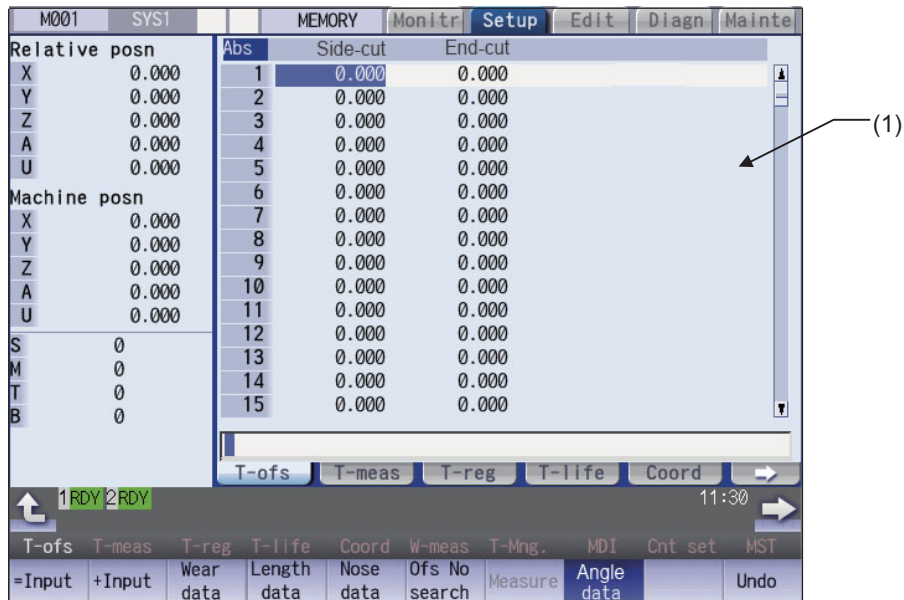

Set the side-cutting-edge angle and end-cutting-edge angle for each tool to be used. When a tool compensation number is designated by the tool command (T command), the compensation operation is performed with the tool length data, wear data and cutting-edge angle data during compound type fixed cycle for turning machining I.



**CAUTION**

If the tool compensation amount or workpiece coordinate system offset amount is changed during automatic operation (including during single block stop), the changes will be valid from the command in the next block or after several subsequent blocks.

## Display items

| Display items    | Details                                                                                                                                                                                                                                                                                                                                                                                                                                                                                                                                                                                                                                                                                                                                                                                                                           |
|------------------|-----------------------------------------------------------------------------------------------------------------------------------------------------------------------------------------------------------------------------------------------------------------------------------------------------------------------------------------------------------------------------------------------------------------------------------------------------------------------------------------------------------------------------------------------------------------------------------------------------------------------------------------------------------------------------------------------------------------------------------------------------------------------------------------------------------------------------------|
| (1) Display area | <p>Displays the tool compensation data. The cursor is displayed, and you can set the data. The data exceeding the display area can be displayed by the following keys.</p> <p>  : Scroll one line at a time.</p> <p>  : Switches the display contents for each number of compensation data sets.</p> <p>Compensation number: This is a compensation data number.</p> <p>The other display items change depending on the tool compensation type. Refer to the following table for details.</p> |

<Standard setting/display range >

The display range is when the minimum command unit is 1 $\mu$ m ("#1003 iunit"= B, "#1041 Initial inch" = 0).

| Type | Setting item      | Details                                                                                                                                                                                                                                                                                                                                        | Setting/display range             |
|------|-------------------|------------------------------------------------------------------------------------------------------------------------------------------------------------------------------------------------------------------------------------------------------------------------------------------------------------------------------------------------|-----------------------------------|
| I    | Compensation data | Sets the tool length compensation amount. (*5)                                                                                                                                                                                                                                                                                                 | -9999.999 to 9999.999             |
| II   | Length            | Sets the tool length compensation amount. (*5)                                                                                                                                                                                                                                                                                                 | Length dimension/Radius dimension |
|      | L wear            | Set the compensation amount of tool length wear. (*5)                                                                                                                                                                                                                                                                                          | -9999.999 to 9999.999             |
|      | Radius            | Sets the tool radius compensation amount. (*5)                                                                                                                                                                                                                                                                                                 | Length wear/Radius wear           |
|      | R wear            | Set the tool radius wear compensation amount. (*5)                                                                                                                                                                                                                                                                                             | -9999.999 to 9999.999             |
| III  | Wear data         | <p>&lt;L system&gt;<br/>Sets the wear compensation amount of 1st axis, 2nd axis, additional axis, and 2nd additional axis.<br/>(*1)(*2)(*5)(*7)(*8)(*10)</p> <p>&lt;M system&gt;<br/>Sets the wear compensation of the axes designated by the parameters "#1026 base_I", "#1027 base_J" and "#1028 base_K". (*5)(*9)(*10)</p>                  | -9999.999 to 9999.999             |
|      | Tool length data  | <p>&lt;L system&gt;<br/>Sets the tool length compensation amount of 1st axis, 2nd axis, additional axis, and 2nd additional axis.<br/>(*1)(*2)(*7)(*8)(*10)</p> <p>&lt;M system&gt;<br/>Sets the tool length compensation amount of the axes designated by the parameters "#1026 base_I", "#1027 base_J" and "#1028 base_K". (*5)(*9)(*10)</p> | -9999.999 to 9999.999             |
|      | Nose R (*3)(*6)   | Sets the tool radius (Nose R).                                                                                                                                                                                                                                                                                                                 | -9999.999 to 9999.999             |
|      | R wear (*3)(*6)   | Sets the tool radius (Nose R) wear.                                                                                                                                                                                                                                                                                                            | -9999.999 to 9999.999             |
|      | Point (*4)        | Sets the nose point (number).                                                                                                                                                                                                                                                                                                                  | 0 to 9                            |
|      | Side-cut (*4)     | Sets the side-cutting-edge angle.                                                                                                                                                                                                                                                                                                              | 0.000 to 180.000                  |
|      | End-cut (*4)      | Sets the end-cutting-edge angle.                                                                                                                                                                                                                                                                                                               | 0.000 to 180.000                  |

(\*1) Select the additional axis by specifying the parameter (#1281 ext17 bit1/#1520 Tch34).

(\*2) If the number of axes in the part system is 2 or less, the name of non-existing axis is displayed according to the parameter setting as follows. Setting the compensation amount to non-existing axis does not mean anything.

If "#1281 (PR) ext17/bit1" (Tool offset additional axis selection) is set to "0":

The axis name is not displayed.

If "#1281 (PR) ext17/bit1" (Tool offset additional axis selection) is set to "1":

If the 2nd axis does not exist, the axis name designated by "#1028 base\_K" is displayed. If the additional axis does not exist, the axis name designated by "#1027 base\_J" is displayed.

(\*3) If parameter "#1019 dia" (Diameter command) is set to "0", set the radius. If it is set to "1", set the diameter.

(\*4) The nose point, side-cutting-edge angle and end-cutting-edge angle are entered as the absolute position even if you press the menu [+ Input].

6 Setting a Tool and a Workpiece

- (\*5) It may differ from the above display/setting range depending on the parameter setting of "#8010 ABS. MAX." or "#8011 INC. MAZ."
- (\*6) It may differ from the above display/setting range depending on the parameter setting of "#8010 ABS. MAX."
- (\*7) The axis names set by the parameter "#1022 axname2" are displayed for 1st axis, 2nd axis, additional axis, and 2nd additional axis.
- (\*8) The 2nd additional axis can be set or displayed when the parameter "#12103 2nd add T-ofs ON" is set to "1". The axis name is not displayed when a non-existing axis is designated by the parameter "#12104 2nd add T-ofs".
- (\*9) The 2nd axis names set by "#1022 axname2" are displayed for the axes set in the parameters "#1026 base\_I", "#1027 base\_J" and "#1028 base\_K". However, if any axes designated by the parameter "#1026 base\_I" to "#1028 base\_K" does not exist, the axis name of the parameter "#1026 base\_I" to "#1028 base\_K" will be displayed instead.
- (\*10) The tool compensation data of an axis which has been set to "1" (hide) by the parameter "#12117 T-ofs hide axis" is not displayed.

The setting/display ranges are as follows based on the combination of "#1003 iunit" (Input unit) and "#1041 Initial inch".

| #1003 iunit | #1041 I_inch | Setting/display range                                                 |                                                                                             |
|-------------|--------------|-----------------------------------------------------------------------|---------------------------------------------------------------------------------------------|
|             |              | Type II (Length wear/Radius wear)<br>Type III (Wear data/Radius wear) | Type I<br>Type II (Length dimension/Radius dimension)<br>Type III (Tool length data/Nose R) |
| B           | 0            | -999.999 to 999.999                                                   |                                                                                             |
|             |              | -9999.999 to 9999.999                                                 |                                                                                             |
|             | 1            | -99.9999 to 99.9999                                                   |                                                                                             |
|             |              | -999.9999 to 999.9999                                                 |                                                                                             |
| C           | 0            | -999.9999 to 999.9999                                                 |                                                                                             |
|             |              | -9999.9999 to 9999.9999                                               |                                                                                             |
|             | 1            | -99.99999 to 99.99999                                                 |                                                                                             |
|             |              | -999.99999 to 999.99999                                               |                                                                                             |
| D           | 0            | -999.99999 to 999.99999                                               |                                                                                             |
|             |              | -9999.99999 to 9999.99999                                             |                                                                                             |
|             | 1            | -99.999999 to 99.999999                                               |                                                                                             |
|             |              | -999.999999 to 999.999999                                             |                                                                                             |
| E           | 0            | -999.999999 to 999.999999                                             |                                                                                             |
|             |              | -9999.999999 to 9999.999999                                           |                                                                                             |
|             | 1            | -99.9999999 to 99.9999999                                             |                                                                                             |
|             |              | -999.9999999 to 999.9999999                                           |                                                                                             |

When data without the decimal point is input, a set unit can be specified by the parameter "#8119 Comp. unit switch".

The standard settings and display ranges are as follows.

| Type | Display position                                 |
|------|--------------------------------------------------|
| I    | Top of display area (*1)                         |
| II   | Left side of radius (*1)                         |
|      | Left side of radius wear (*1)                    |
| III  | <L system> Left side of axis name (*2)           |
|      | <M system> Nose R, left side of radius wear (*1) |

(\*1) It is displayed when the parameter "#8117 OFS Diam DESIGN" is "1".

(\*2) It is displayed at the left of axis name when the parameter "#1019 dia" (Diameter command) is set to "1".

## Menus



| Menus         | Details                                                                                                                                                                                                                                                                                                                                                                          |
|---------------|----------------------------------------------------------------------------------------------------------------------------------------------------------------------------------------------------------------------------------------------------------------------------------------------------------------------------------------------------------------------------------|
| =Input        | This executes an absolute input.<br>When "#8929 Disable=INPUT:comp" is set to "1", this menu cannot be selected.                                                                                                                                                                                                                                                                 |
| +Input        | This executes an incremental input.<br><Note><br>♦This menu is disabled while the cutting-edge angle data is displayed.                                                                                                                                                                                                                                                          |
| Wear data     | This switches to the wear data display.<br><Note><br>♦This menu is displayed for type III only.                                                                                                                                                                                                                                                                                  |
| Length data   | This switches to the tool length data display.<br><Note><br>♦This menu is displayed for type III only.                                                                                                                                                                                                                                                                           |
| Nose data     | This switches to the nose data display.<br><Note><br>♦This menu is displayed for type III only.                                                                                                                                                                                                                                                                                  |
| Ofs No search | When the compensation No. is set and the [INPUT] key is pressed, the tool compensation data with that number at its head appears.<br>The cursor moves to the contents of that first line.                                                                                                                                                                                        |
| Measure       | Measure the tool compensation amount.<br><Note><br>♦This menu is displayed only for type III, and is valid for "L system" and "tool length data display".                                                                                                                                                                                                                        |
| Angle data    | This switches to the cutting-edge angle data display.<br><Note><br>♦This menu is displayed for type III only. This menu is disabled for M system.                                                                                                                                                                                                                                |
| Undo          | This undoes the last changes to the tool compensation data.<br>(This menu is valid for the "Data Input", "Paste Line" and "Undo" operations.)<br><Note><br>♦When an operation parameter "#8939 Undo confirm msg" is set to "1", the menu is highlighted while the operation message is displayed.                                                                                |
| Line copy     | This copies the contents of the tool compensation data in the selected line (one line).                                                                                                                                                                                                                                                                                          |
| Line paste    | The contents (one line) of the copied tool compensation data are written to the line where the cursor is.<br>If the copied data is changed after the menu [Line copy] is pressed, the data before changing is written when pasted.<br>The data in the copied line can be pasted as many times as is required until new data is copied.                                           |
| Line clear    | This erases the compensation data in the selected line (multiple lines can be erased).<br>Selection method: Select the first and the last compensation number to be erased.<br>(Example) 1/E: Set all compensation data to "0".<br>If the [INPUT] key is pressed without selecting a line, the compensation data in the line where the cursor is currently positioned is erased. |
| Abs/Inc       | Switch the setting method (absolute/incremental input) for the tool compensation data by [INPUT] key.<br><Note><br>♦When a parameter "#8941 ABS/INC for T-ofs" is set to "0", it is fixed to an absolute input.                                                                                                                                                                  |

With type III, wear data is displayed when the power is turned ON.

After turning the power ON, the display selection for wear data, length data, nose data and cutting-edge angle data are retained.

## 6.4.1 Setting the Tool Compensation Data

**Operation method (Setting "10.000" in the length wear data of compensation No. (102))**

- (1) Press the menu [Ofs No search].
- (2) Designate the compensation No.  
102 [INPUT]  
The cursor can be moved to 102 using the [↑], [↓],  
 or  keys.
- (3) Use the [→] key to move the cursor to the length wear position.
- (4) Input the length wear value.  
10 [INPUT]  
The value can also be designated by pressing the menu [=Input] instead of the [INPUT] key.

**Note**

- (1) If the parameter "#11017 T-ofs set at run" is set to "1", the tool compensation amount data during automatic operation or during pause of operation can be set.
- (2) When the parameter "#8929 Disable=INPUT:comp" is set to "1", the menu [=Input] will be grayed.
- (3) This setting may be disabled due to the parameter "#8933 Disable lngth comp" or "8934 Disable wear comp" setting. For details, refer to "6.4.6 Disabling the Setting of Tool Compensation Amount".
- (4) The above shows the setting of the tool compensation data when the parameter "#8941 ABS/INC for T-ofs" is set to "0". For details, refer to "6.4.2 Switching the Input Method for the Tool Compensation Data".
- (5) Any of the menu [=Input], [+Input] or [INPUT] key is pressed when the parameter "#1124 ofsfix" is set to "0", the cursor will move to the next compensation No.



**Operation method ("0.012" is calculated and set in the length wear data of compensation No. 102)**

(1) Use the same procedure as in the previous page to move the cursor to the compensation No. 102 length wear position.

(2) Input a numeric value.  
0.012 [+Input]



The input value added to the original value is displayed.  
(Example) When the original value is 10.000, the calculation formula is as follows:

$$10.000 + 0.012 = 10.012$$

**Note**

- (1) If the parameter "#11017 T-ofs set at run" is set to "1", the tool compensation amount data during automatic operation or during pause of operation can be set.
- (2) This setting may be disabled due to the parameter "#8933 Disable lngth comp" or "8934 Disable wear comp" setting. For details, refer to "6.4.6 Disabling the Setting of Tool Compensation Amount".
- (3) Any of the menu [=Input], [+Input] or [INPUT] key is pressed when the parameter "#1124 ofsfix" is set to "0", the cursor will move to the next compensation No.
- (4) When entering data without decimal points, you can select the 1-mm (or 1-inch) data input or the input in the minimum input unit (same as "#1003 iunit") by designating the "#8119 Comp. unit switch" parameter.

<1-mm unit: "#8119 Comp. unit switch" is "0".>

| Input | Result  |
|-------|---------|
| 1     | 1.000   |
| 100   | 100.000 |
| 10.   | 10.000  |
| .012  | 0.012   |



<Minimum input unit (#1003 iunit B): "#8119 Comp. unit switch" is "1".>

| Input | Result |
|-------|--------|
| 1     | 0.001  |
| 100   | 0.100  |
| 10.   | 10.000 |
| .012  | 0.012  |



**Operation method (Input multiple tool compensation data at a time)**



(Example) Setting "10.000" in "X1" and "20.000" in "Z1" for respective tool length data of the compensation No. 102

(1) Press the menu [Ofs No search].

(2) Designate the compensation No.

102 [INPUT]

The cursor can be moved to 102 using the [↑],

[↓],  or  key.



The designated No. is displayed at the top of the compensation No. area.

(3) Set a value.

Input the data for each column dividing with "/".

1st column/2nd column/3rd column/4th column

10/20 [INPUT]

The value can also be set by pressing the menu [=Input] instead of the [INPUT] key.



The designated values are set.

| Tool offset |            |           |           |          | SYS1 |
|-------------|------------|-----------|-----------|----------|------|
|             | oLength X1 | Length Z1 | Length C1 | Length   |      |
| 102         | 10.000     | 20.000    | 0.000     | 0.000    |      |
| 103         | 0.000      | 0.000     | 0.000     | 0.000    |      |
| 104         | 0.000      | 0.000     | 0.000     | 0.000    |      |
| 105         | 0.000      | 0.000     | 0.000     | 0.000    |      |
| 106         | 0.000      | 0.000     | 0.000     | 0.000    |      |
| 107         | 0.000      | 0.000     | 0.000     | 0.000    |      |
| 108         | -123.456   | 123.000   | 123.456   | -123.000 |      |
| 109         | 0.000      | 0.000     | 0.000     | 0.000    |      |
| 110         | 0.000      | 0.000     | 0.000     | 0.000    |      |
| 111         | 0.000      | 0.000     | 0.000     | 0.000    |      |
| 112         | 0.000      | 0.000     | 0.000     | 0.000    |      |
| 113         | 0.000      | 0.000     | 0.000     | 0.000    |      |
| 114         | 0.000      | 0.000     | 0.000     | 0.000    |      |
| 115         | 0.000      | 0.000     | 0.000     | 0.000    |      |

**Note**

- (1) If the parameter "#11017 T-ofs set at run" is set to "1", the tool compensation amount data during automatic operation or during pause of operation can be set.
- (2) When the parameter "#8929 Disable=INPUT:comp" is set to "1", the menu [=Input] will be grayed.
- (3) This setting may be disabled due to the parameter "#8933 Disable lngth comp" or "8934 Disable wear comp" setting. For details, refer to "6.4.6 Disabling the Setting of Tool Compensation Amount".
- (4) The above shows the setting of the tool compensation data when the parameter "#8941 ABS/INC for T-ofs" is set to "0". For details, refer to "6.4.2 Switching the Input Method for the Tool Compensation Data".
- (5) Any of the menu [=Input], [+Input] or [INPUT] key is pressed when the parameter "#1124 ofsfix" is set to "0", the cursor will move to the next compensation No.
- (6) Compensation data for the number of the columns currently being displayed can be set at a time.
- (7) When you input multiple tool compensation data at a time, the first data will be set at the leftmost column of the selected line regardless of the current cursor position.
- (8) Inputting of multiple tool compensation data is available for the tool compensation type II and III.
- (9) When you input multiple tool compensation data at a time with the tool compensation type III, the data of the axis which is set not to be displayed (parameter "#12117 T-ofs hide axis" is set to "1") is skipped.  
For example, when the 2nd column is set not to be displayed, input the data with the following format to set the tool compensation data for the 1st column and the 3rd column at a time.

1st column/3rd column/4th column

30/40 [INPUT]

## 6.4.2 Switching the Input Method for the Tool Compensation Data

When a parameter "#8941 ABS/INC for T-ofs" is set to "1", the absolute/incremental input by the [INPUT] key can be switched. When attempting to switch it, the current input mode is displayed on the upper left of the tool compensation amount. The absolute/incremental input can be switched either by the short cut key ([I] key) or by pressing the menu [Abs/Inc]. The chosen method is kept after switching the screen and turning the power OFF.

## (1) Absolute input mode

In this mode, the absolute input is applied when the tool compensation data is input by the [INPUT] key.

Displaying that this is the absolute input mode.

| Abs |       |    |       |    |       |
|-----|-------|----|-------|----|-------|
| 1   | 0.000 | 16 | 0.000 | 31 | 0.000 |
| 2   | 0.000 | 17 | 0.000 | 32 | 0.000 |
| 3   | 0.000 | 18 | 0.000 | 33 | 0.000 |
| 4   | 0.000 | 19 | 0.000 | 34 | 0.000 |
| 5   | 0.000 | 20 | 0.000 | 35 | 0.000 |
| 6   | 0.000 | 21 | 0.000 | 36 | 0.000 |
| 7   | 0.000 | 22 | 0.000 | 37 | 0.000 |
| 8   | 0.000 | 23 | 0.000 | 38 | 0.000 |
| 9   | 0.000 | 24 | 0.000 | 39 | 0.000 |
| 10  | 0.000 | 25 | 0.000 | 40 | 0.000 |
| 11  | 0.000 | 26 | 0.000 | 41 | 0.000 |
| 12  | 0.000 | 27 | 0.000 | 42 | 0.000 |
| 13  | 0.000 | 28 | 0.000 | 43 | 0.000 |
| 14  | 0.000 | 29 | 0.000 | 44 | 0.000 |
| 15  | 0.000 | 30 | 0.000 | 45 | 0.000 |

T-ofs | T-meas | T-reg | T-life | Coord | →

## (2) Incremental input mode

In this mode, the incremental input is applied when the tool compensation data is input by the [INPUT] key.



Displaying that this is the incremental input mode.

| Inc |       |    |       |    |       |
|-----|-------|----|-------|----|-------|
| 1   | 0.000 | 16 | 0.000 | 31 | 0.000 |
| 2   | 0.000 | 17 | 0.000 | 32 | 0.000 |
| 3   | 0.000 | 18 | 0.000 | 33 | 0.000 |
| 4   | 0.000 | 19 | 0.000 | 34 | 0.000 |
| 5   | 0.000 | 20 | 0.000 | 35 | 0.000 |
| 6   | 0.000 | 21 | 0.000 | 36 | 0.000 |
| 7   | 0.000 | 22 | 0.000 | 37 | 0.000 |
| 8   | 0.000 | 23 | 0.000 | 38 | 0.000 |
| 9   | 0.000 | 24 | 0.000 | 39 | 0.000 |
| 10  | 0.000 | 25 | 0.000 | 40 | 0.000 |
| 11  | 0.000 | 26 | 0.000 | 41 | 0.000 |
| 12  | 0.000 | 27 | 0.000 | 42 | 0.000 |
| 13  | 0.000 | 28 | 0.000 | 43 | 0.000 |
| 14  | 0.000 | 29 | 0.000 | 44 | 0.000 |
| 15  | 0.000 | 30 | 0.000 | 45 | 0.000 |

T-ofs | T-meas | T-reg | T-life | Coord | →

## 6.4.3 Erasing the Tool Compensation Data

**Operation method (Erasing one line of tool compensation data at the cursor position)**

- (1) Move the cursor to the data to be erased using the [↑], [↓], , or  key.
- (2) Press the menu [Line clear] and the [INPUT] key.
- (3) Press the [Y] or [INPUT] key.  
To cancel the erasing, press a key other than [Y] or [INPUT].  The selected line of data (one line amount) is cleared to "0".  
The cleared data is displayed at the top of the compensation data.

**Operation method (Erasing the compensation data from compensation number 122 to 125.)**

- (1) Press the menu [Line clear].
- (2) Input the compensation number of the data range to be erased.  
122/125 [INPUT]
- (3) Press the [Y] or [INPUT] key.  
To cancel the erasing, press a key other than [Y] or [INPUT].  The compensation data for the selected compensation number is erased, and the menu highlight returns to normal.  
The cleared data is displayed at the top of the compensation data.



**Note**

- (1) If the [INPUT] key is pressed without selecting a compensation number, the line where the cursor is located is erased.
- (2) If the parameter "#11017 T-ofs set at run" is set to "1", the tool compensation amount data during automatic operation or during pause of operation can be erased.
- (3) This setting may be disabled due to the parameter "#8933 Disable lngth comp" or "8934 Disable wear comp" setting. For details, refer to "6.4.6 Disabling the Setting of Tool Compensation Amount".

## 6.4.4 Copying and Pasting the Tool Compensation Data

**Operation method (Copying/pasting one line of tool compensation data)**

- (1) Move the cursor to the data to be copied using the [↑],

[↓],  or  key.

- (2) Press the menu [Line copy].

- (3) Move the cursor to the line (compensation No.: 109) where the data is to be pasted.

- (4) Press the menu [Line paste].



The copied compensation data is written in the line where the cursor is.

The background color returns to normal.

The copied compensation data is held until another line is copied.

**Note**

- (1) If the compensation data for the copied line is changed after the menu [Line copy] is pressed, the data prior to the change is written when pasted.
- (2) In tool compensation type III, the copied data cannot be pasted to the different item (Wear/Length/Nose).
- (3) If the parameter "#11017 T-ofs set at run" is set to "1", the tool compensation amount data during automatic operation or during pause of operation can be erased.
- (4) This setting may be disabled due to the parameter "#8933 Disable lngth comp" or "8934 Disable wear comp" setting. For details, refer to "6.4.6 Disabling the Setting of Tool Compensation Amount".

## 6.4.5 Undoing Change of Tool Compensation Data

- (1) Move the cursor to the data to be set using the [↑], [↓],

, or  key.

- (2) Input a numeric value.  
(Example) 10 [INPUT]

- (3) Press the menu [Undo].



The value is returned to the previous value.

**Note**

- (1) This setting will be disabled due to the parameter "#8933 Disable lngth comp" or "#8934 Disable wear comp" setting. For details, refer to "6.4.6 Disabling the Setting of Tool Compensation Amount".
- (2) When "#8939 Undo confirm msg" is set to "1", the menu [Undo] is highlighted and confirmation message "OK?(Y/N)" is displayed. The program returns to the previous status by pressing [Y] or [INPUT] key. If any key other than [Y] or [INPUT] is pressed, the operation to undo will be canceled. When the operation is canceled, the menu highlight returns to normal and the message disappears.
- (3) When the program does not return to the previous status by pressing [Undo], [Undo] is not highlighted and the operation message "Data protect" or "Cannot return to origin" appears.
- (4) The menu [Undo] cannot be used to clear multiple lines.

## 6.4.6 Disabling the Setting of Tool Compensation Amount

Depending on the setting of the parameter "#8933 Disable lngth comp"/"#8934 Disable wear comp", the setting of the shape compensation amount/wear compensation amount is disabled.

Depending on the tool compensation type, different operation will be disabled.

| Tool compensation type |                      | "#8933 Disable lngth comp" = "1"                                                                                                                                                    | "#8934 Disable wear comp" = "1"                                                                                                                                                               |
|------------------------|----------------------|-------------------------------------------------------------------------------------------------------------------------------------------------------------------------------------|-----------------------------------------------------------------------------------------------------------------------------------------------------------------------------------------------|
| <b>Type I</b>          | ----                 | The menus [=Input], [+Input], [Line copy], [Line paste], [Line clear], and [Undo] are grayed out and cannot be selected.<br>Any setting by [INPUT] key is disabled.                 | ----                                                                                                                                                                                          |
| <b>Type II</b>         | ----                 | The menus [Line copy], [Line paste], and [Line clear] are grayed out and cannot be selected.<br>The length and radius setting by [=Input], [+Input], and [INPUT] keys are disabled. | The menus [Line copy], [Line paste], and [Line clear] are grayed out and cannot be selected.<br>The length wear and radius wear setting by [=Input], [+Input], and [INPUT] keys are disabled. |
| <b>Type III</b>        | "Wear"               | ----                                                                                                                                                                                | The menus [=Input], [+Input], [Line copy], [Line paste], [Line clear], and [Undo] are grayed out and cannot be selected.<br>Any setting by [INPUT] key is disabled.                           |
|                        | "Length"             | The menus [=Input], [+Input], [Measure], [Line copy], [Line paste], [Line clear], and [Undo] are grayed out and cannot be selected.<br>Any setting by [INPUT] key is disabled.      | ----                                                                                                                                                                                          |
|                        | "Nose"               | The menus [Line copy], [Line paste], and [Line clear] are grayed out and cannot be selected.<br>The nose R setting by [=Input], [+Input], and [INPUT] keys are disabled.            | The menus [Line copy], [Line paste], and [Line clear] are grayed out and cannot be selected.<br>The R wear setting by [=Input], [+Input], and [INPUT] keys are disabled.                      |
|                        | "Cutting-edge angle" | The menus [=Input], [Line copy], [Line paste], [Line clear] and [Undo] are grayed out and cannot be selected.<br>Any setting by [INPUT] key is disabled.                            | ----                                                                                                                                                                                          |

### 6.4.7 Measuring Tool Compensation Amount

The measurement method will differ depending on the setting of the parameter "#11087 Meas basic point".

**Measuring the tool compensation amount of Z axis and X axis (diameter axis) with the machine zero point designation method (#11087 = 0)**

- (1) Select the tool to be measured with manual numerical value command. (Refer to "9.6 Manual Numerical Value Command" for details.)  
(Example) T1003

- (2) Displays the tool compensation amount screen.  
Menu [Offset]



The tool compensation amount screen is displayed. The tool compensation number of the selected tool is displayed at the top, and the cursor is located on the first line.

<Note>

- If the parameter "#8972 T code offset disp" is set to "0", the tool compensation number of selected tool is not displayed at the top. Locate the cursor onto the tool compensation number of the tool to be measured.
- When the axis to apply the mirror image is to be measured, turn ON the mirror image.

- (3) Press the menu [Length data].
- (4) Select the "Manual handle feed" mode or "Jog feed" mode.
- (5) Select the Z axis, and manually move the tool to the work end face (program origin).

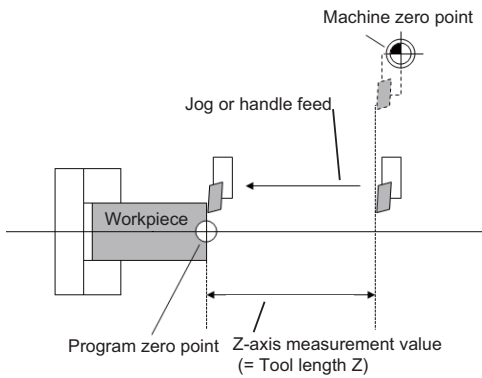

- (6) Enter the name of axis to be measured, and the measurement value (radius) of workpiece.  
Z0.

When you enter "Z", the cursor is moved to the Z axis column.

<Note>

- If you input an axis name that does not exist, the cursor does not move.
- The second and subsequent characters are not considered to be the axis name and, therefore, the cursor does not move. (Example: If you enter "XZ", the cursor moves on the X axis, but the cursor does not move on the Z axis.)  
Also, if anything other than tool length data is displayed, the cursor does not move even when the first input value is the axis name.
- If multiple axes which have the same first letter of the axis name set by the parameter "#1022 ax-name2" exist, the axis address key moves the cursor to the first found axis (in the order of 1st axis --> 2nd axis --> additional axis --> 2nd additional axis).  
When you want to move the cursor to a low priority axis, input the axis name to be measured and the measurement value (radius value) of the workpiece before moving the cursor to the target axis with [←] or [→] key.

Value "Z0." is displayed in the input column.

- (7) Press the menu [Measure].

The measured value (Z axis machine position - Input value (0)) is set in the tool length data at the cursor position. The input column is cleared.

<Note>

- For the axis to which the mirror image is turned ON, the measurement position considering the mirror state is displayed.

- (8) Select the X axis, and manually move the tool to the work side face.

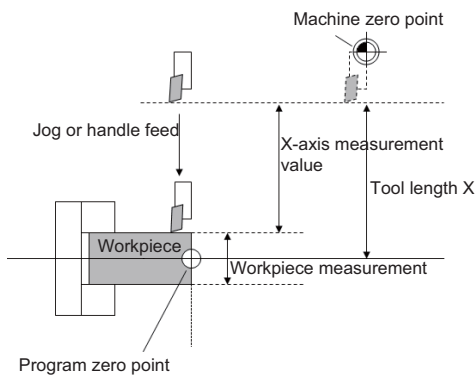



6 Setting a Tool and a Workpiece

- (9) Enter the name of axis to be measured, and the measurement value (diameter) of workpiece. X20.

When you enter "X", the cursor is moved to the X-axis column.

<Note>

- If you input an axis name that does not exist, the cursor does not move.
  - The second and subsequent characters are not considered to be the axis name and, therefore, the cursor does not move. (Example: If you enter "XZ", the cursor moves on the X axis, but the cursor does not move on the Z axis.)
- Also, if anything other than tool length data is displayed, the cursor does not move even when the first input value is the axis name.
- If multiple axes which have the same first letter of the axis name set in the parameter "#1022 ax-name2" exist, the axis address key moves the cursor to the first found axis (in the order of 1st axis --> 2nd axis --> additional axis --> 2nd additional axis). When you want to move the cursor to a low priority axis, input the axis name to be measured and the measurement value (radius value) of the workpiece before moving the cursor to the target axis with [←] or [→] key.

Value "X20." is displayed in the input column.

- (10) Press the menu [Measure].

The measured value (X-axis machine position - Input value (20)) is set in the tool length data at the cursor position. The input column is cleared.

<Note>

- For the axis to which the mirror image is turned ON, the measurement position considering the mirror status is displayed.

**Note**

- (1) If the parameter "#11017 T-ofs set at run" is set to "1", the tool compensation amount data during automatic operation or during pause of operation can be measured.
- (2) This setting may be disabled due to the parameter "#8933 Disable lngth comp" or "8934 Disable wear comp" setting. For details, refer to "6.4.6 Disabling the Setting of Tool Compensation Amount".
- (3) When entering data without decimal points, you can select the 1-mm (or 1-inch) data input or the input in the minimum input unit (same as "#1003 iunit") by designating the "#8119 Comp. unit switch" parameter.

<1-mm unit: "#8119 Comp. unit switch" is "0".>

| Input | Result  |
|-------|---------|
| 1     | 1.000   |
| 100   | 100.000 |
| 10.   | 10.000  |
| .012  | 0.012   |



<Minimum input unit (#1003 iunit B): "#8119 Comp. unit switch" is "1".>

| Input | Result |
|-------|--------|
| 1     | 0.001  |
| 100   | 0.100  |
| 10.   | 10.000 |
| .012  | 0.012  |



**Measuring the tool compensation amount of Z axis and X axis (diameter axis) with the parameter designation method (when #11087 = 1)**

- (1) Select the tool to be measured with manual numerical value command. (Refer to "9.6 Manual Numerical Value Command" for details.)

(Example) T1003

- (2) Displays the tool compensation amount screen.  
Menu [Offset]



The tool compensation amount screen is displayed. The tool compensation number of the selected tool is displayed at the top, and the cursor is located on the first line.

<Note>

- If the parameter "#8972 T code offset disp" is set to "0", the tool compensation number of selected tool is not displayed at the top. Locate the cursor onto the tool compensation number of the tool to be measured.

- (3) Press the menu [Tool length data].



This switches to the tool length data display.

<Note>

- When the axis to apply the mirror image is to be measured, turn ON the mirror image.

- (4) Select the "Manual handle feed" mode or "Jog feed" mode.

- (5) Select the Z axis, and manually move the tool to the work side face.

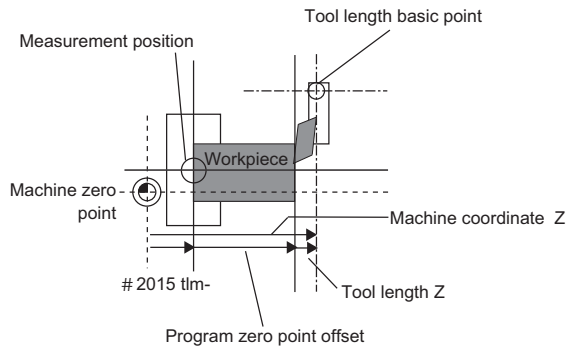

- (6) Enter the name of axis to be measured, and the measurement value (radius) of workpiece. Z50.

When you enter "Z", the cursor is moved to the Z axis column.

<Note>

- If you input an axis name that does not exist, the cursor does not move.
  - The second and subsequent characters are not considered to be the axis name and, therefore, the cursor does not move. (Example: If you enter "XZ", the cursor moves on the X axis, but the cursor does not move on the Z axis.)
- Also, if anything other than tool length data is displayed, the cursor does not move even when the first input value is the axis name.
- If multiple axes which have the same first letter of the axis name set by the parameter "#1022 ax-name2" exist, the axis address key moves the cursor to the first found axis (in the order of 1st axis --> 2nd axis --> additional axis --> 2nd additional axis). When you want to move the cursor to a low priority axis, input the axis name to be measured and the measurement value (radius value) of the workpiece before moving the cursor to the target axis with [←] or [→] key.

Value "Z50." is displayed in the input column.

- (7) Press the menu [Measure].

The measured value (Z axis machine position - measurement zero point (#2015 tml-) - Input value (50)) is set in the tool length data at the cursor position. The input column is cleared.

<Note>

- For the axis to which the mirror image is turned ON, the measurement position considering the mirror status is displayed.

- (8) Select the X axis, and manually move the tool to the work side face.

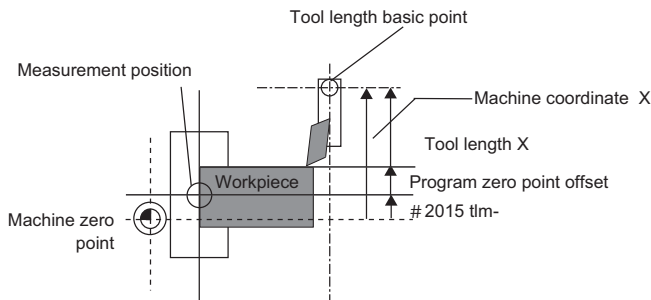

- (9) Enter the name of axis to be measured, and the measurement value (diameter) of workpiece.  
X20.



When you enter "X", the cursor is moved to the X-axis column.

<Note>

- If you input an axis name that does not exist, the cursor does not move.
- The second and subsequent characters are not considered to be the axis name and, therefore, the cursor does not move. (Example: If you enter "XZ", the cursor moves on the X axis, but the cursor does not move on the Z axis.)
- If multiple axes which have the same first letter of the axis name set by the parameter "#1022 ax-name2" exist, the axis address key moves the cursor to the first found axis (in the order of 1st axis --> 2nd axis --> additional axis --> 2nd additional axis). When you want to move the cursor to a low priority axis, input the axis name to be measured and the measurement value (radius value) of the workpiece before moving the cursor to the target axis with [←] or [→] key.

Value "X20." is displayed in the input column.

- (10) Press the menu [Measure].



The measured value (X axis machine position - measurement zero point (#2015 tml-) - Input value (20)) is set in the tool length data at the cursor position. The input column is cleared.

<Note>

- For the axis to which the mirror image is turned ON, the measurement position considering the mirror status is displayed.

**Note**

- (1) If the parameter "#11017 T-ofs set at run" is set to "1", the tool compensation amount data during automatic operation or during pause of operation can be measured.
- (2) This setting may be disabled due to the parameter "#8933 Disable lngth comp" or "8934 Disable wear comp" setting. For details, refer to "6.4.6 Disabling the Setting of Tool Compensation Amount".
- (3) When entering data without decimal points, you can select the 1-mm (or 1-inch) data input or the input in the minimum input unit (same as "#1003 iunit") by designating the parameter "#8119 Comp. unit switch".

<1-mm unit: "#8119 Comp. unit switch" is "0".>

| Input | ➔ | Result  |
|-------|---|---------|
| 1     |   | 1.000   |
| 100   |   | 100.000 |
| 10.   |   | 10.000  |
| .012  |   | 0.012   |

<Minimum input unit (#1003 iunit B): "#8119 Comp. unit switch" is "1".>

| Input | ➔ | Result |
|-------|---|--------|
| 1     |   | 0.001  |
| 100   |   | 0.100  |
| 10.   |   | 10.000 |
| .012  |   | 0.012  |

**Measuring the tool compensation amount of Z axis and X axis (diameter axis) with the workpiece coordinate system offset designation method (when #11087 = 2)**

- (1) Select the tool to be measured with manual numerical value command. (Refer to "9.6 Manual Numerical Value Command" for details.)  
(Example) T1003

- (2) Displays the tool compensation amount screen. Menu [Offset]



The tool compensation amount screen is displayed. The tool compensation number of the selected tool is displayed at the top, and the cursor is located on the first line.

<Note>

- If the parameter "#8972 T code offset disp" is set to "0", the tool compensation number of selected tool is not displayed at the top. Locate the cursor onto the tool compensation number of the tool to be measured.

- (3) Press the menu [Tool length data].



This switches to the tool length data display.

- (4) Select the "Manual handle feed" mode or "Jog feed" mode.

- (5) Select the Z axis, and manually move the tool to the work side face.

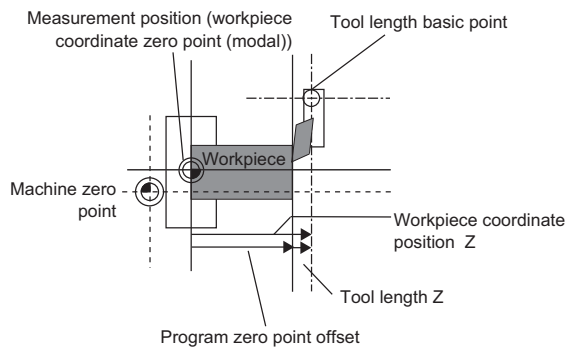

- (6) Enter the name of axis to be measured, and the measurement value (radius) of workpiece.  
Z50.

➔ When you enter "Z", the cursor is moved to the Z axis column.

<Note>

- If you input an axis name that does not exist, the cursor does not move.
- The second and subsequent characters are not considered to be the axis name and, therefore, the cursor does not move. (Example: If you enter "XZ", the cursor moves on the X axis, but the cursor does not move on the Z axis.)  
Also, if anything other than tool length data is displayed, the cursor does not move even when the first input value is the axis name.
- If multiple axes which have the same first letter of the axis name set by the parameter "#1022 ax-name2" exist, the axis address key moves the cursor to the first found axis (in the order of 1st axis --> 2nd axis --> additional axis --> 2nd additional axis).  
When you want to move the cursor to a low priority axis, input the axis name to be measured and the measurement value (radius value) of the workpiece before moving the cursor to the target axis with [←] or [→] key.

Value "Z50." is displayed in the input column.

- (7) Press the menu [Measure].

➔ The measured value (Z axis workpiece coordinate position - Input value (50)) is set in the tool length data at the cursor position.  
The input column is cleared.

- (8) Select the X axis, and manually move the tool to the work side face.

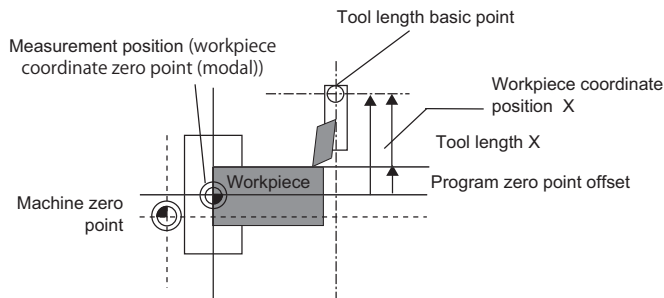

- (9) Enter the name of axis to be measured, and the measurement value (diameter) of workpiece.  
X20.

When you enter "X", the cursor is moved to the X-axis column.

<Note>

- ♦If you input an axis name that does not exist, the cursor does not move.
- ♦The second and subsequent characters are not considered to be the axis name and, therefore, the cursor does not move. (Example: If you enter "XZ", the cursor moves on the X axis, but the cursor does not move on the Z axis.)  
Also, if anything other than tool length data is displayed, the cursor does not move even when the first input value is the axis name.
- ♦If multiple axes which have the same first letter of the axis name set by the parameter "#1022 ax-name2" exist, the axis address key moves the cursor to the first found axis (in the order of 1st axis --> 2nd axis --> additional axis --> 2nd additional axis). When you want to move the cursor to a low priority axis, input the axis name to be measured and the measurement value (radius value) of the workpiece before moving the cursor to the target axis with [←] or [→] key.

Value "X20." is displayed in the input column.

- (10) Press the menu [Measure].

The measured value (X axis workpiece coordinate position - Input value (20)) is set in the tool length data at the cursor position.  
The input column is cleared.

**Note**

- (1) If the parameter "#11017 T-ofs set at run" is set to "1", the tool compensation amount data during automatic operation or during pause of operation can be measured.
- (2) This setting may be disabled due to the parameter "#8933 Disable lngth comp" or "8934 Disable wear comp" setting. For details, refer to "6.4.6 Disabling the Setting of Tool Compensation Amount".
- (3) When entering data without decimal points, you can select the 1-mm (or 1-inch) data input or the input in the minimum input unit (same as "#1003 iunit") by designating the "#8119 Comp. unit switch" parameter.

<1-mm unit: "#8119 Comp. unit switch" is "0".>

| Input | → | Result  |
|-------|---|---------|
| 1     |   | 1.000   |
| 100   |   | 100.000 |
| 10.   |   | 10.000  |
| .012  |   | 0.012   |

<Minimum input unit (#1003 iunit B): "#8119 Comp. unit switch" is "1".>

| Input | → | Result |
|-------|---|--------|
| 1     |   | 0.001  |
| 100   |   | 0.100  |
| 10.   |   | 10.000 |
| .012  |   | 0.012  |

### 6.4.8 Moving to designated Compensation Number

There are two methods to switch from the designated compensation number display. You can switch the operation by using the "#8975 Change No. search" parameter.

(Example 1) Select compensation number 16. (If "#8975 Change No. search" is "0")

- (1) Displays the tool compensation amount screen.
- (2) Press the menu [Ofs No search].
- (3) Enter the compensation number you wish to display, and press [INPUT].  
16 [INPUT]  The compensation number that you have set is displayed at the top, and the cursor is located on the first data. The highlighting of the menu [Ofs No. search] is canceled.

(Example 2) Select compensation number 16. (If "#8975 Change No. search" is "1")



- (1) Displays the tool compensation amount screen.
- (2) Enter the compensation number you wish to display.  
16
- (3) Press the menu [Ofs No search].  The compensation number that you have set is displayed at the top, and the cursor is located on the first data.

#### **Note**

- (1) If a compensation number exceeding the limit is designated, the operation message "Setting error" is displayed.



### 6.5 Setting the Tool Management Data (Tool Management Screen)

- Setup —  (M system)
- Setup —  (L system)

Tool management data can be set and displayed on the tool management (T-Mng.) screen. These data are relevant to which displayed on the [T-ofs] or [T-life] screen, that can be set the tool information. Thus the mutually-referenced data can be set and displayed on this screen.

■List view

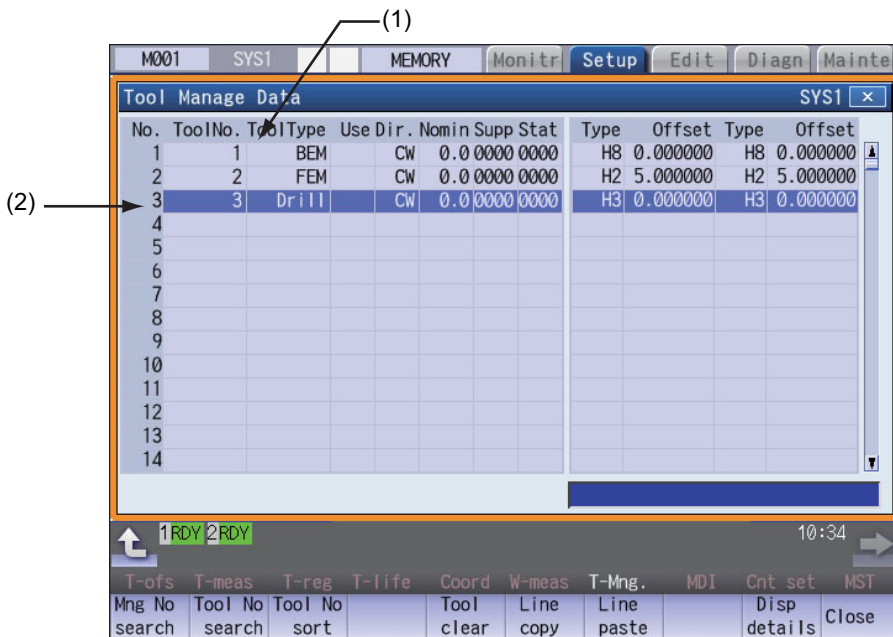

■Detailed display

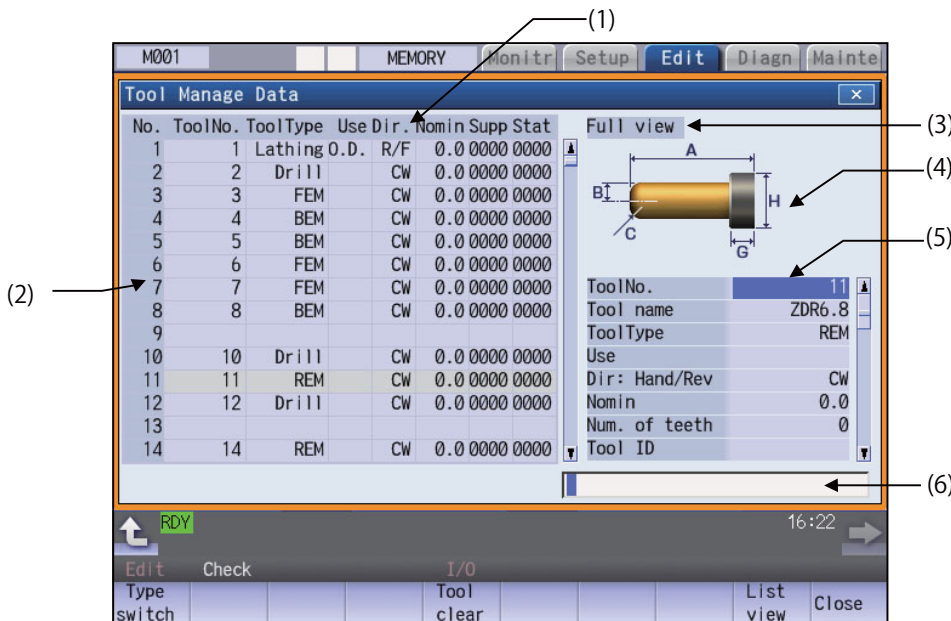

## Display items

| Display items                             | Details                                                                                                                                                                                                                                                                                                                       |
|-------------------------------------------|-------------------------------------------------------------------------------------------------------------------------------------------------------------------------------------------------------------------------------------------------------------------------------------------------------------------------------|
| (1) Tool management data list portion     | The preset tool management data is listed.<br>The tool management data list consists of the right side and left side parts.<br>When you select the [Tool Manage Data - Detail View] and switch to the [Detail View], the right part of the tool management data list is switched to the detail view of tool management data.  |
| (2) Data No.                              | Indicates the number of the tool management data.                                                                                                                                                                                                                                                                             |
| (3) Display data type                     | It indicates the item type that is displayed in the detail view of tool management data.<br>The display data type can be "Full view" (*1), "Custom" (*2) (*3), "Basic info", "Shape info", "Cut cond.", "Offset", "T-life", or "Added info".<br>After the power is turned ON again, the last display data type is maintained. |
| (4) Tool shape drawing                    | It displays the tool shape of the tool management data at cursor position according to the tool type.<br>The display and hiding are switched according to the display data type.                                                                                                                                              |
| (5) Tool management data detailed portion | Displays or sets the tool data that has been selected from the tool management data list.<br>The display items are changed depending on the tool type and the display data type.                                                                                                                                              |
| (6) Input section                         | This displays the input data.                                                                                                                                                                                                                                                                                                 |

(\*1) The display items differ depending on MTB settings.

(\*2) The display data type of "Custom" is "Full view". This may not be displayed depending on MTB settings.

(\*3) The type names and item list differ depending on MTB settings.

6.5.1 List of Display Items

○: Display/setting enabled      ●: Display only      -: Non-display

| Display data         |                     |                    | Tool management data list portion |             | Tool management data detailed portion |             |            |            |           |         |        |            |
|----------------------|---------------------|--------------------|-----------------------------------|-------------|---------------------------------------|-------------|------------|------------|-----------|---------|--------|------------|
|                      |                     |                    | Left side                         | Right side  | Full view                             | Custom (*9) | Basic info | Shape info | Cut cond. | Off-set | T-life | Added info |
| Tool shape drawing   |                     |                    | -                                 | -           | ○                                     | ○           | ○          | ○          | -         | -       | -      | -          |
| Tool management data | Basic info          | Tool No.           | ○                                 | -           | ○                                     | ○           | ○          | ○          | ○         | ○       | ○      | ○          |
|                      |                     | Tool name          | -                                 | -           | ○ (*10)                               | ○ (*10)     | ○          | -          | -         | -       | -      | -          |
|                      |                     | Tool type          | ○                                 | -           | ○                                     | ○           | ○          | ○          | ○         | ○       | ○      | ○          |
|                      |                     | Use                | ○                                 | -           | ○ (*10)                               | ○ (*10)     | ○          | -          | -         | -       | -      | -          |
|                      |                     | Dir: Hand/Rev (*1) | ○                                 | -           | ○ (*10)                               | ○ (*10)     | ○          | -          | -         | -       | -      | -          |
|                      |                     | Nomin              | ○                                 | -           | ○ (*10)                               | ○ (*10)     | ○          | -          | -         | -       | -      | -          |
|                      |                     | Num. of teeth      | -                                 | -           | ○ (*10)                               | ○ (*10)     | ○          | -          | ○ (*8)    | -       | -      | -          |
|                      |                     | Tool ID            | -                                 | -           | ○ (*10)                               | ○ (*10)     | ○          | -          | -         | -       | -      | -          |
|                      |                     | Supp               | ○                                 | -           | ○ (*10)                               | ○ (*10)     | -          | -          | -         | -       | -      | -          |
|                      |                     | Stat               | ●                                 | -           | ● (*10)                               | ● (*10)     | -          | -          | -         | -       | -      | -          |
|                      |                     | Setting Angle      | -                                 | -           | ○ (*10)                               | ○ (*10)     | -          | ○          | -         | -       | -      | -          |
|                      |                     | GangTool ofs Y     | -                                 | -           | ○ (*10)                               | ○ (*10)     | -          | ○          | -         | -       | -      | -          |
|                      | Shape info (*2)     |                    | -                                 | -           | ○ (*10)                               | ○ (*10)     | -          | ○          | -         | -       | -      | -          |
|                      | Cut cond.           | Spindle rpm S      | -                                 | -           | ○ (*10)                               | ○ (*10)     | -          | -          | ○         | -       | -      | -          |
|                      |                     | Feedrate F         | -                                 | -           | ○ (*10)                               | ○ (*10)     | -          | -          | ○         | -       | -      | -          |
|                      |                     | Material           | -                                 | -           | ○ (*10)                               | ○ (*10)     | -          | -          | ○         | -       | -      | -          |
|                      |                     | Coolant M code     | -                                 | -           | ○ (*10)                               | ○ (*10)     | -          | -          | ○         | -       | -      | -          |
| Added info           | Custom 1 to 12 (*3) | -                  | -                                 | ○ (*4)(*10) | ○ (*10)                               | -           | -          | -          | -         | -       | ○ (*4) |            |
| Life (*5)            |                     | -                  | -                                 | -           | ○ (*10)                               | -           | -          | -          | -         | ○       | -      |            |
| Compensation         |                     | -                  | ○ (*6)                            | -           | ○ (*10)                               | -           | -          | -          | ○ (*7)    | -       | -      |            |

(\*1) In case of mill tools, lathing drill and lathing tap, "rotation" is applied, while in case of lathe turning, groove and thread cut, "tool hand" is applied.

(\*2) The display/setting contents differ depending on the tool types. Refer to "List of display items for shape info" in this section for details of setting items.

(\*3) The display/setting format and setting range of display item names, number of items and setting values depend on MTB specifications.

(\*4) When the parameter "#1445 Tol-Custom-nondisp" is set to "1", "Added info" is not displayed.

(\*5) The display/setting contents differ depending on the tool compensation type and tool life management type. Refer to "List of display items for life data" in this section for details of setting items.

(\*6) The display contents differ depending on the tool compensation type and parameter "#8969 Tool offset type 1" and "#8970 Tool offset type 2". Refer to "List of display items for compensation data (List view)" in this section for details of setting items.

(\*7) The display/setting contents differ depending on the tool compensation type. Refer to "List of display items for compensation data (Disp details)" in this section for details of setting items.

(\*8) The item displays between "Material" and "Coolant M code".

(\*9) The type name "Custom" differs depending on MTB specifications.

(\*10) This may not be displayed depending on MTB specifications.

**List of display items for shape info**

The display contents of shape info differ depending on the selected tools.

[Mill tools]

○: Display/setting enabled

-: Not used

| Item           | Tool type      |               |               |            |                 |           |           |            |
|----------------|----------------|---------------|---------------|------------|-----------------|-----------|-----------|------------|
|                | Not set        | Ball end mill | Flat end mill | Drill      | Radius end mill | Chamfer   | Tap       | Face mill  |
| :A             | Length         |               |               |            |                 |           |           |            |
| :B             | Diameter       |               |               |            |                 |           |           |            |
| :C             | -              | -             | -             | Nose angle | Corner R        | Tip angle | Pitch     | Cutter L   |
| :D             | -              | -             | -             | -          | -               | Tip dia.  | Root dia. | Shank dia. |
| :E             | -              | -             | -             | -          | -               | -         | -         | -          |
| :F             | -              | -             | -             | -          | -               | -         | -         | -          |
| :G             | Holder H       |               |               |            |                 |           |           |            |
| :H             | Holder D       |               |               |            |                 |           |           |            |
| 3D CHK Tool CR | 3D CHK Tool CR |               |               |            |                 |           |           |            |

[Turning tools]

○: Display/setting enabled

-: Not used

| Item           | Tool type          |                      |            |               |             |
|----------------|--------------------|----------------------|------------|---------------|-------------|
|                | Lathe turning      | Groove               | Thread cut | Lathing drill | Lathing tap |
| :A             | Tool length A      |                      |            |               |             |
| :B             | Tool length B      |                      |            |               |             |
| :C             | Nose R             | Nose R               | -          | Nose angle    | Pitch       |
| :D             | Nose angle         | Nose width           | -          | -             | Root dia.   |
| :E             | Cutting edge angle | Maximum groove depth | -          | -             | -           |
| :F             | Tool width         | Tool width           | Tool width | -             | -           |
| :G             | Holder H           |                      |            |               |             |
| :H             | Holder D           |                      |            |               |             |
| 3D CHK Tool CR | 3D CHK Tool CR     |                      |            |               |             |

## List of display items of life data

○: Display/setting enabled    ●: Display only    -: Non-display

| Display data (Life data) |                   | M system                  |                          | L system               |                         |
|--------------------------|-------------------|---------------------------|--------------------------|------------------------|-------------------------|
|                          |                   | Tool life management I/II | Tool life management III | Tool life management I | Tool life management II |
| Life                     | Group No.         | ○                         | -                        | -                      | ○                       |
|                          | Status            | ○                         | ○                        | -                      | ○ (*2)                  |
|                          | Mthd              | ○                         | ○                        | -                      | ●                       |
|                          | H No.             | ○                         | ○                        | -                      | -                       |
|                          | L compen          | ○                         | ○                        | -                      | -                       |
|                          | D No.             | ○                         | ○                        | -                      | -                       |
|                          | R compen          | ○                         | ○                        | -                      | -                       |
|                          | Auxil.            | ○                         | ○                        | -                      | -                       |
|                          | Ofset No          | -                         | -                        | -                      | ○                       |
|                          | Life (*1)         | ○                         | ○                        | -                      | ●                       |
|                          | Used (*1)         | ○                         | ○                        | -                      | ○                       |
|                          | Usage time (*1)   | -                         | -                        | ○                      | -                       |
|                          | Life time (*1)    | -                         | -                        | ○                      | -                       |
|                          | Usage count (*1)  | -                         | -                        | ○                      | -                       |
|                          | T life count (*1) | -                         | -                        | ○                      | -                       |
|                          | Status A          | -                         | -                        | ○                      | -                       |
| Status B                 | -                 | -                         | ○                        | -                      |                         |

(\*1) Setting values and units are displayed.

(\*2) Status is displayed under "Used".

## List of display items for compensation data (List view)

The parameter "#8969 Tool offset type 1" enables to switch the display items for 1st and 2nd column and the parameter "#8970 Tool offset type 2" enables to switch the display items for 3rd and 4th column on the right side of the list view.

[Tool compensation type I]

Tool compensation No. displays in the 1st column, tool compensation amount displays in the 2nd column and 3rd and 4th column are set to blank, irrespective of the value set by the parameter.

#8969 Tool offset type 1

| Setting value | 1st column (type)       | 2nd column (compensation amount) |
|---------------|-------------------------|----------------------------------|
| 0 to 11       | H tool compensation No. | Length compensation              |

#8970 Tool offset type 2

—: Blank

| Setting value | 3rd column | 4th column |
|---------------|------------|------------|
| 0 to 11       | -          | -          |

[Tool compensation type II/ Tool compensation type III (M system)]

#8969 Tool offset type 1

| Setting value | 1st column (type)        | 2nd column (compensation amount) |
|---------------|--------------------------|----------------------------------|
| 0, 5 to 11    | H tool compensation No.  | Length compensation              |
| 1             | H tool compensation No.  | Length compensation              |
| 2             | D tool compensation No.  | Radius compensation              |
| 3             | +H tool compensation No. | Length wear                      |
| 4             | +D tool compensation No. | Radius wear                      |

## #8970 Tool offset type 2

| Setting value | 3rd column (type)        | 4th column (compensation amount) |
|---------------|--------------------------|----------------------------------|
| 0, 5 to 11    | D tool compensation No.  | R compen                         |
| 1             | H tool compensation No.  | L compen                         |
| 2             | D tool compensation No.  | R compen                         |
| 3             | +H tool compensation No. | L wear                           |
| 4             | +D tool compensation No. | R wear                           |

[Tool compensation type III (L system)]

## #8969 Tool offset type 1

| Setting value | 1st column (type) (*1)                             | 2nd column (compensation amount) |
|---------------|----------------------------------------------------|----------------------------------|
| 0             | "1st axis name" tool compensation No.              | 1st axis tool length             |
| 1             | "1st axis name" tool compensation No.              | 1st axis tool length             |
| 2             | "2nd axis name" tool compensation No.              | 2nd axis tool length             |
| 3             | "Additional axis name" tool compensation No.       | Additional axis tool length      |
| 4             | "+ 1st axis name" tool compensation No.            | 1st axis wear                    |
| 5             | "+ 2nd axis name" tool compensation No.            | 2nd axis wear                    |
| 6             | "+ Additional axis name" tool compensation No.     | Additional axis wear             |
| 7             | R                                                  | Nose R                           |
| 8             | +R                                                 | R wear                           |
| 9             | P                                                  | Point                            |
| 10            | "2nd additional axis name" tool compensation No.   | 2nd additional axis tool length  |
| 11            | "+ 2nd additional axis name" tool compensation No. | 2nd additional axis wear         |

## #8970 Tool offset type 2

| Setting value | 3rd column (type) (*1)                             | 4th column (compensation amount) |
|---------------|----------------------------------------------------|----------------------------------|
| 0             | "2nd axis name" tool compensation No.              | 2nd axis tool length             |
| 1             | "1st axis name" tool compensation No.              | 1st axis tool length             |
| 2             | "2nd axis name" tool compensation No.              | 2nd axis tool length             |
| 3             | "Additional axis name" tool compensation No.       | Additional axis tool length      |
| 4             | "+ 1st axis name" tool compensation No.            | 1st axis wear                    |
| 5             | "+ 2nd axis name" tool compensation No.            | 2nd axis wear                    |
| 6             | "+ Additional axis name" tool compensation No.     | Additional axis wear             |
| 7             | R                                                  | Nose R                           |
| 8             | +R                                                 | R wear                           |
| 9             | P                                                  | Point                            |
| 10            | "2nd additional axis name" tool compensation No.   | 2nd additional axis tool length  |
| 11            | "+ 2nd additional axis name" tool compensation No. | 2nd additional axis wear         |

(\*1) Names set in "#1013 axname" corresponding to the axis are displayed in "\*\*\*\* axis name".

**Note**

(1) For the compensation amount, when "#1041 I\_Inch" is set to "0" (metric system), the fraction part is fixed in 3 digits and when it is set to "1" (inch system), the fraction part is fixed in 4 digits, and the values after those digits are cut off.

List of display items for compensation data (Disp details)

○: Display/setting enabled      -: Non-display

| Display data (Compensation data) |                                                         | Tool compensation type I | Tool compensation type II | Tool compensation type III |          |
|----------------------------------|---------------------------------------------------------|--------------------------|---------------------------|----------------------------|----------|
|                                  |                                                         |                          |                           | L system                   | M system |
| Compensation                     | H No.                                                   | ○                        | ○                         | -                          | -        |
|                                  | D No.                                                   | -                        | ○                         | -                          | -        |
|                                  | Length                                                  | ○                        | ○                         | -                          | -        |
|                                  | L wear                                                  | -                        | ○                         | -                          | -        |
|                                  | Radius (*3)                                             | -                        | ○                         | -                          | -        |
|                                  | R wear (*3)                                             | -                        | ○                         | -                          | -        |
|                                  | Tool L offset #                                         | -                        | -                         | ○                          | ○        |
|                                  | Wear offset #                                           | -                        | -                         | ○                          | ○        |
|                                  | Tool length "1st axis name" (*1)(*2)(*4)(*7)            | -                        | -                         | ○                          | -        |
|                                  | Tool length "2nd axis name" (*1)(*2)(*4)(*7)            | -                        | -                         | ○                          | -        |
|                                  | Tool length "Additional axis name" (*1)(*2)(*4)(*7)     | -                        | -                         | ○                          | -        |
|                                  | Tool length "2nd additional axis name" (*1)(*4)(*5)(*7) | -                        | -                         | ○                          | -        |
|                                  | Tool length "Axis name set in "base_I"" (*1)(*6)(*7)    | -                        | -                         | -                          | ○        |
|                                  | Tool length "Axis name set in "base_J"" (*1)(*6)(*7)    | -                        | -                         | -                          | ○        |
|                                  | Tool length "Axis name set in "base_K"" (*1)(*6)(*7)    | -                        | -                         | -                          | ○        |
|                                  | Wear "1st axis name" (*1)(*2)(*4)(*7)                   | -                        | -                         | ○                          | -        |
|                                  | Wear "2nd axis name" (*1)(*2)(*4)(*7)                   | -                        | -                         | ○                          | -        |
|                                  | Wear "Additional axis name" (*1)(*2)(*4)(*7)            | -                        | -                         | ○                          | -        |
|                                  | Wear "2nd additional axis name" (*1)(*4)(*5)(*7)        | -                        | -                         | ○                          | -        |
|                                  | Wear "Axis name set in "base_I"" (*1)(*6)(*7)           | -                        | -                         | -                          | ○        |
|                                  | Wear "Axis name set in "base_J"" (*1)(*6)(*7)           | -                        | -                         | -                          | ○        |
|                                  | Wear "Axis name set in "base_K"" (*1)(*6)(*7)           | -                        | -                         | -                          | ○        |
|                                  | Nose R (*3)                                             | -                        | -                         | ○                          | ○        |
|                                  | R wear (*3)                                             | -                        | -                         | ○                          | ○        |
|                                  | Point                                                   | -                        | -                         | ○                          | ○        |
|                                  | Side-cut                                                | -                        | -                         | ○                          | -        |
|                                  | End-cut                                                 | -                        | -                         | ○                          | -        |

(\*1) Names set by the parameter "#1022 axname2" corresponding to the axis are displayed in "\*\*\*\* axis name".

(\*2) If the number of axes in the part system is 2 or less, the name of non-existing axis is displayed according to the setting of the parameter "#1281 ext17/bit1" (Selection of additional tool offset axis) as follows.

0: The axis name is not displayed.

1: The axis name designated by "#1028 base\_K" is displayed in the 2nd axis, and the axis name designated by "#1027 base\_J" is displayed in the additional axis.

(\*3) When the parameter "#8117 OFS Diam DESIGN" is set to "1", the symbol "Φ" is displayed on the right side of the item name.

(\*4) When "#1019 dia" (Diameter specification axis) is set to "1" for the axis, the symbol "Φ" is displayed on the right side of the item name.



(\*5) The axis that is set in "#12104 2nd add T-ofs set" is displayed in the 2nd additional axis name. If it does not set, the axis name is not displayed. Also, when "#12103 2nd add T-ofs ON" is set to "0", the line for the 2nd additional axis is not displayed.

(\*6) The 2nd axis names set by "#1022 axname2" are displayed for the axes set in the parameters "#1026 base\_I", "#1027 base\_J" and "#1028 base\_K". However, if any axes designated by the parameter "#1026 base\_I" to "#1028 base\_K" does not exist, the axis name of the parameter "#1026 base\_I" to "#1028 base\_K" will be displayed instead.



(\*7) The tool compensation data of an axis which has been set to "1" (hide) by the parameter "#12117 T-ofs hide axis" is not displayed.

## 6.5.2 Data Setting Range

The value of each item is maintained even after the power is turned OFF and ON.

| Setting item  | Details                                                                                                                                                                                                                                                                                                                                                                                                                                                                                                                                                                                                                                                                                                                                                                                                                                                                                                                                                                 | Setting range                                                                                                                                                                                                                                                                          |
|---------------|-------------------------------------------------------------------------------------------------------------------------------------------------------------------------------------------------------------------------------------------------------------------------------------------------------------------------------------------------------------------------------------------------------------------------------------------------------------------------------------------------------------------------------------------------------------------------------------------------------------------------------------------------------------------------------------------------------------------------------------------------------------------------------------------------------------------------------------------------------------------------------------------------------------------------------------------------------------------------|----------------------------------------------------------------------------------------------------------------------------------------------------------------------------------------------------------------------------------------------------------------------------------------|
| Tool No.      | Sets the tool No.<br>A maximum of 8 digits of data can be input.                                                                                                                                                                                                                                                                                                                                                                                                                                                                                                                                                                                                                                                                                                                                                                                                                                                                                                        | 1 to 99999999                                                                                                                                                                                                                                                                          |
| Name          | Sets the tool name.<br>A maximum of 8 alphanumeric characters and symbols can be set for the name. (*1)                                                                                                                                                                                                                                                                                                                                                                                                                                                                                                                                                                                                                                                                                                                                                                                                                                                                 | A maximum of 8 characters                                                                                                                                                                                                                                                              |
| Type          | Sets the tool type.<br>The tool type will be "Drill" when no value is input.                                                                                                                                                                                                                                                                                                                                                                                                                                                                                                                                                                                                                                                                                                                                                                                                                                                                                            | 1: Ball end mill<br>2: Flat end mill<br>3: Drill<br>4: Radius end mill<br>5: Chamfer<br>6: Tap<br>7: Face mill<br>51: Lathe turning<br>52: Groove<br>53: Thread cut<br>54: Lathing drill<br>55: Lathing tap                                                                            |
| Use           | Sets the usage of the tool.                                                                                                                                                                                                                                                                                                                                                                                                                                                                                                                                                                                                                                                                                                                                                                                                                                                                                                                                             | 0: None<br>1: Outer diameter<br>2: Inner diameter<br>3: End face                                                                                                                                                                                                                       |
| Dir: Hand/Rev | <p>This sets the tool hand and spindle rotation direction. The items to be set vary depending on the tool type.</p> <p>&lt;Tools that are set by spindle rotation direction&gt;<br/>Mill tools, lathing drill and lathing tap</p> <p>&lt;Tools that are set by tool hand&gt;<br/>Lathe turning, groove, thread cut</p> <p>For turning tool or grooving tool, the tool direction will change depending on the tool hand setting.</p> <p>&lt;Example of turning tool&gt;</p> <div style="display: flex; justify-content: space-around; align-items: center;"> <div style="text-align: center;"> <p>Right hand/Back<br/>Left hand/Back</p>  <p>Workpiece<br/>back</p> </div> <div style="text-align: center;"> <p>Right hand/Front<br/>Left hand/Front</p>  <p>Workpiece<br/>front</p> </div> </div> | <p>&lt;Spindle rotation direction&gt;<br/>0: CW<br/>1: CCW</p> <p>&lt;Tool hand&gt;<br/>0: Right/Front (R/F)<br/>1: Left/Front (L/F)<br/>2: Right/Back (R/B)<br/>3: Left/Back (L/B)</p> <p>&lt;Note&gt;<br/>♦The codes in parentheses are displayed in "Tool Manage Data" section.</p> |
| Nomin         | Sets the nominal of the tools.<br>When milling tools are selected in types, "nominal diameter" can be set and when turning tools are selected, "nominal" can be set.                                                                                                                                                                                                                                                                                                                                                                                                                                                                                                                                                                                                                                                                                                                                                                                                    | Setting range varies depending on the parameter "#1041 Initial inch".<br>mm: 0.0 to 999.9<br>inch: 0.00 to 99.99                                                                                                                                                                       |
| Num. of teeth | Sets the number of teeth of the tools with 1 digit.<br>When lathe turning, groove and thread cut tools are selected, it is grayed out and cannot be set.                                                                                                                                                                                                                                                                                                                                                                                                                                                                                                                                                                                                                                                                                                                                                                                                                | 0 to 9                                                                                                                                                                                                                                                                                 |
| Tool ID       | Sets the information arbitrarily to identify the tools such as tool model No. described in a catalog.<br>A maximum of 8 alphanumeric characters and symbols can be set for the ID. (*1)                                                                                                                                                                                                                                                                                                                                                                                                                                                                                                                                                                                                                                                                                                                                                                                 | A maximum of 8 characters                                                                                                                                                                                                                                                              |
| Supp          | Sets the supplementary information of the tools.<br>The display/setting values depend on MTB specifications.                                                                                                                                                                                                                                                                                                                                                                                                                                                                                                                                                                                                                                                                                                                                                                                                                                                            | 0x0000 to 0xFFFF                                                                                                                                                                                                                                                                       |
| Stat          | Displays the status of the tools.<br>It cannot be set and only reference is available.<br>The displayed values depend on MTB specifications.                                                                                                                                                                                                                                                                                                                                                                                                                                                                                                                                                                                                                                                                                                                                                                                                                            | -                                                                                                                                                                                                                                                                                      |

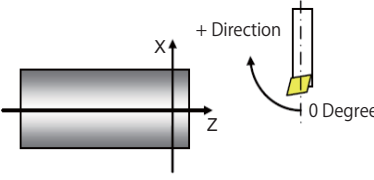

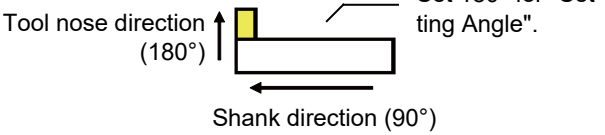
| Setting item  | Details                                                                                                                                                                                                                                                                                                                                                                                                                                                                                                                                                                                                                                                                                                                                                                                                                                                                                                                                                              | Setting range        |
|---------------|----------------------------------------------------------------------------------------------------------------------------------------------------------------------------------------------------------------------------------------------------------------------------------------------------------------------------------------------------------------------------------------------------------------------------------------------------------------------------------------------------------------------------------------------------------------------------------------------------------------------------------------------------------------------------------------------------------------------------------------------------------------------------------------------------------------------------------------------------------------------------------------------------------------------------------------------------------------------|----------------------|
| Setting Angle | <p>Sets the tool installation angle.<br/>Specifies the angle, assuming the direction perpendicular to Z axis as 0 degrees with CW as positive (+).</p>  <p>&lt;Setting example&gt;<br/>           Setting angle = 90      Setting angle = 180      Setting angle = 270</p>  <p>When there is a tool rotary axis, set the angle assuming that the angle of the axis is 0 degrees.</p> <p>If the directions of the tool nose and shank are different such as internal diameter machining tool, set the tool nose angle for "Setting Angle".</p> <p>&lt;Example of grooving tool for front face machining&gt;</p>  <p>Tool nose direction (180°)      Set 180° for "Setting Angle".<br/>Shank direction (90°)</p> | 0 to 359.999 degrees |

## 6 Setting a Tool and a Workpiece

| Setting item    | Details                                                                                                            | Setting range                                                                                                  |
|-----------------|--------------------------------------------------------------------------------------------------------------------|----------------------------------------------------------------------------------------------------------------|
| Length : A      | Tool type: all tools<br>Sets the tool length.                                                                      | <Length><br>Setting range varies depending on the parameter "#1041 Initial inch".                              |
| Diameter : B    | Tool type: Mill tools, lathing drill and lathing tap<br>Sets the tool diameter. (*2)                               | mm: 0.000 to 9999.999<br>inch: 0.0000 to 999.9999                                                              |
| Length : B      | Tool type: Lathe turning, groove, thread cut<br>Sets the tool length.                                              | <Angle><br>0.000 to 180.000 degrees                                                                            |
| Nose angle : C  | Tool type: Drill<br>Sets the nose angle.                                                                           |                                                                                                                |
| Corner R : C    | Tool type: Radius end mill<br>Sets the corner R circular radius.                                                   |                                                                                                                |
| Tip angle : C   | Tool type: Chamfer<br>Sets the tip angle.                                                                          |                                                                                                                |
| Pitch : C       | Tool type: Tap<br>Sets the pitch.                                                                                  |                                                                                                                |
| Cutter L : C    | Tool type: Face mill<br>Sets the cutter length.                                                                    |                                                                                                                |
| Nose R : C      | Tool type: Lathe turning, groove<br>Sets the nose R.                                                               |                                                                                                                |
| Tip dia. : D    | Tool type: Chamfer<br>Sets the tool tip diameter. (*2)                                                             |                                                                                                                |
| Root dia. : D   | Tool type: Tap<br>Sets the root diameter.                                                                          |                                                                                                                |
| Shank dia. : D  | Tool type: Face mill<br>Sets the shank diameter. (*2)                                                              |                                                                                                                |
| Nose angle : D  | Tool type: Lathe turning<br>Sets the nose angle.                                                                   |                                                                                                                |
| Nose width : D  | Tool type: Groove<br>Sets the nose width                                                                           |                                                                                                                |
| Edge angle : E  | Tool type: Lathe turning<br>Sets the edge angle.                                                                   |                                                                                                                |
| Max groove D: E | Tool type: Groove<br>Sets the groove depth.                                                                        |                                                                                                                |
| Tool width: F   | Tool type: Lathe turning, groove, thread cut<br>Sets the tool width.                                               |                                                                                                                |
| Holder H: G     | Tool type: all tools<br>Sets the holder height.                                                                    |                                                                                                                |
| Holder D : H    | Tool type: all tools<br>Sets the holder diameter.                                                                  |                                                                                                                |
| 3D CHK Tool CR  | Sets the color to be used in 3D check screen.<br>Tool type: all tools<br>Red will be set when no value is input.   | 1: Gray<br>2: Red<br>3: Yellow<br>4: Blue<br>5: Green<br>6: Light blue<br>7: Purple<br>8: Pink                 |
| Spindle rpm S   | Sets the spindle rotation speed.                                                                                   | 0 to 99999999                                                                                                  |
| Feedrate F      | Sets the tool feedrate.                                                                                            | Setting range varies depending on the parameter "#1041 Initial inch".<br>mm: 0 to 1000000<br>inch: 0 to 100000 |
| Material        | Sets the material of the tool.<br>A maximum of 4 alphanumeric characters and symbols can be set for the name. (*1) | A maximum of 4 characters                                                                                      |
| Coolant M code  | Sets the coolant M code.                                                                                           | 0 to 99999999                                                                                                  |

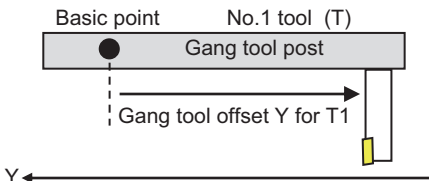
| Setting item   | Details                                                                                                                                                                                                                                                                                                                                                                                                            | Setting range                                                                                                                                 |
|----------------|--------------------------------------------------------------------------------------------------------------------------------------------------------------------------------------------------------------------------------------------------------------------------------------------------------------------------------------------------------------------------------------------------------------------|-----------------------------------------------------------------------------------------------------------------------------------------------|
| GangTool ofs Y | <p>For a machine equipped with a gang tool post, specify the basic point of the gang tool offset Y, and input the offset in Y axis direction between the basic point and each tool. You can determine the basic point in any desired position. You can determine the basic point arbitrarily.</p> <p>&lt;Setting example&gt;</p>  | <p>Setting range varies depending on the parameter "#1041 Initial inch".</p> <p>mm: -9999.999 to 9999.999<br/>inch: -999.9999 to 999.9999</p> |
| Custom 1 to 12 | Sets the custom information.                                                                                                                                                                                                                                                                                                                                                                                       | Display format and setting range vary depending on the MTB specifications.                                                                    |
| Group No.      | Sets the group No.<br>When the group No. is cleared, the life management data is also cleared.                                                                                                                                                                                                                                                                                                                     | 0 to 99999999<br>Group No. is cleared when it is set to "0".                                                                                  |
| Status         | Sets the status. (*3)                                                                                                                                                                                                                                                                                                                                                                                              | Setting range varies depending on the tool life management method.<br>For details, refer to "6.6 Tool Life Management".                       |
| Method         | Sets the method. (*4)(*5)                                                                                                                                                                                                                                                                                                                                                                                          |                                                                                                                                               |
| H No.          | Sets the H No. (*4)                                                                                                                                                                                                                                                                                                                                                                                                |                                                                                                                                               |
| L compen       | Sets the L offset. (*4)                                                                                                                                                                                                                                                                                                                                                                                            |                                                                                                                                               |
| D No.          | Sets the D No. (*4)                                                                                                                                                                                                                                                                                                                                                                                                |                                                                                                                                               |
| R compen       | Sets the R offset. (*4)                                                                                                                                                                                                                                                                                                                                                                                            |                                                                                                                                               |
| Aux.           | Sets the auxiliary data. (*4)                                                                                                                                                                                                                                                                                                                                                                                      |                                                                                                                                               |
| Offset num     | Sets the compensation No.                                                                                                                                                                                                                                                                                                                                                                                          |                                                                                                                                               |
| Life           | Sets the life. (*4)(*5)                                                                                                                                                                                                                                                                                                                                                                                            |                                                                                                                                               |
| Used           | Sets the used. (*3)                                                                                                                                                                                                                                                                                                                                                                                                |                                                                                                                                               |
| Operating time | Sets the maximum life time.                                                                                                                                                                                                                                                                                                                                                                                        |                                                                                                                                               |
| Life time      | Sets the usage life time.                                                                                                                                                                                                                                                                                                                                                                                          |                                                                                                                                               |
| T usage count  | Sets the maximum life count.                                                                                                                                                                                                                                                                                                                                                                                       |                                                                                                                                               |
| T life count   | Sets the usage life count.                                                                                                                                                                                                                                                                                                                                                                                         |                                                                                                                                               |
| Status A       | Sets the status A.                                                                                                                                                                                                                                                                                                                                                                                                 |                                                                                                                                               |
| Status B       | Sets the status B.                                                                                                                                                                                                                                                                                                                                                                                                 |                                                                                                                                               |

| Setting item      | Details                                                                                                                                                                                                                                                                            | Setting range                                                                                                                                    |
|-------------------|------------------------------------------------------------------------------------------------------------------------------------------------------------------------------------------------------------------------------------------------------------------------------------|--------------------------------------------------------------------------------------------------------------------------------------------------|
| H No.             | Sets the H No.                                                                                                                                                                                                                                                                     | Setting range varies depending on the tool compensation type. For details, refer to "6.4 Setting Tool Compensation Amount (Tool Offset Screen)". |
| D No.             | Sets the D No.                                                                                                                                                                                                                                                                     |                                                                                                                                                  |
| Length            | Sets the tool length compensation amount.                                                                                                                                                                                                                                          |                                                                                                                                                  |
| L wear            | Sets the compensation amount of tool length wear.                                                                                                                                                                                                                                  |                                                                                                                                                  |
| Radius            | Sets the tool radius compensation amount.                                                                                                                                                                                                                                          |                                                                                                                                                  |
| R wear            | Sets the compensation amount of tool length wear.                                                                                                                                                                                                                                  |                                                                                                                                                  |
| Tool L offset num | Set the tool L offset No.                                                                                                                                                                                                                                                          |                                                                                                                                                  |
| Wear offset #     | Set the wear offset No.                                                                                                                                                                                                                                                            |                                                                                                                                                  |
| Tool length data  | <L system><br>Sets the tool length compensation amount of 1st axis, 2nd axis, additional axis, and 2nd additional axis. (*6)<br><M system><br>Sets the tool length compensation amount of the axes designated by the parameters "#1026 base_I", "#1027 base_J" and "#1028 base_K". |                                                                                                                                                  |
| Wear data         | <L system><br>Sets the wear compensation amount of 1st axis, 2nd axis, additional axis, and 2nd additional axis. (*6)<br><M system><br>Sets the wear compensation of the axes designated by the parameters "#1026 base_I", "#1027 base_J" and "#1028 base_K".                      |                                                                                                                                                  |
| Nose R            | Sets the nose R.                                                                                                                                                                                                                                                                   |                                                                                                                                                  |
| R-wear            | Sets the R-wear.                                                                                                                                                                                                                                                                   |                                                                                                                                                  |
| Point             | Sets the point.                                                                                                                                                                                                                                                                    |                                                                                                                                                  |
| Side-cut          | Sets the side-cutting-edge angle. (*7)                                                                                                                                                                                                                                             |                                                                                                                                                  |
| End-cut           | Sets the end-cutting-edge angle. (*7)                                                                                                                                                                                                                                              |                                                                                                                                                  |

(\*1) The symbols "/" (Slash), "\" (Backslash), "" (Double quotes) and "=" (Equals) cannot be used for names or IDs. Also, "=" (Equals) cannot be used as the first character.

(\*2) When the parameter "#8968 Tool shape radius" is set to "0", input the value of diameter. When the parameter is set to "1", input the value of radius.

(\*3) In case of tool life management I/II for M system and tool life management II for L system, it cannot be set in the state that group No. is not set.

(\*4) In case of tool life management I/II for M system, it cannot be set in the state that group No. is not set.

(\*5) It cannot be set with tool life management II for L system. Only reference is available.

(\*6) The axis names set by the parameter "#1022 axname2" are displayed for 1st axis, 2nd axis, additional axis, and 2nd additional axis.

(\*7) It cannot be set for M system.

### Note

(1) If a value outside of the setting range is entered, an error occurs, and the value cannot be set.

(2) When the sorting of tool data is in progress, the operation message "Sorting of tool data is in progress" appears, and the data cannot be set.

Refer to the figures below for the graphic and the nose position of each tool.

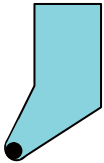
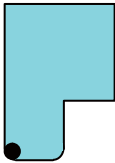
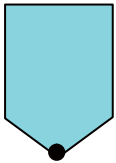
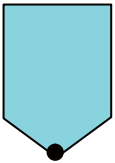
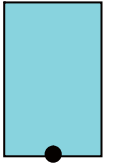
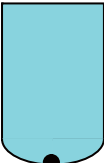
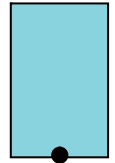
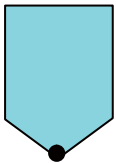
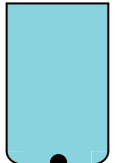
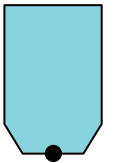
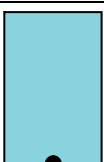
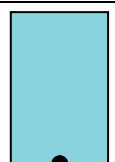
|                                                                                   |                                                                                   |                                                                                   |                                                                                    |                                                                                     |
|-----------------------------------------------------------------------------------|-----------------------------------------------------------------------------------|-----------------------------------------------------------------------------------|------------------------------------------------------------------------------------|-------------------------------------------------------------------------------------|
| Lathe turning                                                                     | Groove                                                                            | Thread cut                                                                        | Lathing drill                                                                      | Lathing tap                                                                         |
|  |  |  |  |  |
| Ball end mill                                                                     | Flat end mill                                                                     | Drill                                                                             | Radius end mill                                                                    | Chamfer                                                                             |
|  |  |  |  |  |
| Tap                                                                               | Face mill                                                                         |                                                                                   |                                                                                    |                                                                                     |
|  |  |                                                                                   |                                                                                    |                                                                                     |

● indicates the tool nose position.

### 6.5.3 Menu Configuration

#### Menus (List view)

| Menus          | Details                                                                                                                                                                                                                                                                                                                                                                           |
|----------------|-----------------------------------------------------------------------------------------------------------------------------------------------------------------------------------------------------------------------------------------------------------------------------------------------------------------------------------------------------------------------------------|
| Mng No search  | Displays the tool management data with the designated tool management number at top.                                                                                                                                                                                                                                                                                              |
| Tool No search | Displays the tool management data with the designated tool number at top.                                                                                                                                                                                                                                                                                                         |
| Tool No sort   | Sorts the tool No. in ascending order.                                                                                                                                                                                                                                                                                                                                            |
| Tool clear     | Clears the tool management data from the cursor line.<br>Setting method: First data number to be cleared/last data number<br>(Example) 10/30: The line data of data numbers 10 to 30 is cleared.<br>10/E: All line data that has data number 10 or less is cleared.<br>If you press the [INPUT] key without entering the data number, data at the current cursor line is cleared. |
| Line copy      | Copies a single line of data locating at the cursor position.                                                                                                                                                                                                                                                                                                                     |
| Line paste     | Writes the copied data (single line data) in the cursor line.                                                                                                                                                                                                                                                                                                                     |
| Disp details   | Switches to the detail view of tool management data.                                                                                                                                                                                                                                                                                                                              |
| Close          | This closes the pop-up window and quits this function.                                                                                                                                                                                                                                                                                                                            |

**Menus (when the cursor is at [ToolNo.] of [Disp details])**

| Menus       | Details                                                                                         |
|-------------|-------------------------------------------------------------------------------------------------|
| Type switch | Switch the display data type of the detail view of tool management data by pressing the button. |
| Tool clear  | Clear the tool management data of the currently selected tool number.                           |
| List view   | Switch to the tool management data list.                                                        |
| Close       | This closes the pop-up window and quits this function.                                          |

**Menus (when the cursor is at [ToolType] of [Disp details])****Note**

(1) For L system, the menus [Lathe turning] to [Lathing tap] are displayed on page 1, the menus [Ballendmill] to [Facemill] are displayed on page 2.

| Menus           | Details                                                                                         |
|-----------------|-------------------------------------------------------------------------------------------------|
| Type switch     | Switch the display data type of the detail view of tool management data by pressing the button. |
| Ball endmill    | Select the [Ball endmill].<br>It is also selected if the value "1" is entered.                  |
| Flat endmill    | Select the [Flat endmill].<br>It is also selected if the value "2" is entered.                  |
| Drill           | Select the [Drill].<br>It is also selected if the value "3" is entered.                         |
| Bulnose endmill | Select the [Bulnoseendmill].<br>It is also selected if the value "4" is entered.                |
| Chamfer         | Select the [Chamfer].<br>It is also selected if the value "5" is entered.                       |
| Tap             | Select the [Tap].<br>It is also selected if the value "6" is entered.                           |
| Face mill       | Select the [Face mill]. It is also selected if the value "7" is entered.                        |
| Close           | This closes the pop-up window and quits this function.                                          |
| Lathe turning   | Select the [Lathe turning]. It is also selected if the value "51" is entered.                   |
| Groove          | Select the [Groove]. It is also selected if the value "52" is entered.                          |
| Thread cut      | Select the [Thread cut]. It is also selected if the value "53" is entered.                      |
| Lathing drill   | Select the [Lathing drill]. It is also selected if the value "54" is entered.                   |
| Lathing tap     | Select the [Lathing tap]. It is also selected if the value "55" is entered.                     |

**Menus (when the cursor is at [3D CHK Tool CR] of [Disp details])**

| Menus       | Details                                                                                         |
|-------------|-------------------------------------------------------------------------------------------------|
| Type switch | Switch the display data type of the detail view of tool management data by pressing the button. |
| Gray        | Select the gray color. It is also selected if the value "1" is entered.                         |
| Red         | Select the red color. It is also selected if the value "2" is entered.                          |
| Yellow      | Select the yellow color. It is also selected if the value "3" is entered.                       |
| Blue        | Select the blue color. It is also selected if the value "4" is entered.                         |
| Green       | Select the green color. It is also selected if the value "5" is entered.                        |
| Light blue  | Select the aqua color. It is also selected if the value "6" is entered.                         |
| Purple      | Select the purple color. It is also selected if the value "7" is entered.                       |
| Pink        | Select the pink color. It is also selected if the value "8" is entered.                         |
| Close       | This closes the pop-up window and quits this function.                                          |

**Menus (when the cursor is at [Use] of [Disp details])**

| Menus       | Details                                                                                                 |
|-------------|---------------------------------------------------------------------------------------------------------|
| Type switch | Switch the display data type of the detail view of tool management data by pressing the button.         |
| Leave blank | Select the [Leave blank]. This column is set to blank. It is also selected if the value "0" is entered. |
| Outer dia.  | Select the [Outer dia.]. It is also selected if the value "1" is entered.                               |
| Inner dia.  | Select the [Inner dia.]. It is also selected if the value "2" is entered.                               |
| End face    | Select the [End face]. It is also selected if the value "3" is entered.                                 |
| List view   | Switch to the tool management data list.                                                                |
| Close       | This closes the pop-up window and quits this function.                                                  |

**Menus (when the cursor is at [Spindle rotation direction] of [Disp details])**

| Menus       | Details                                                                                         |
|-------------|-------------------------------------------------------------------------------------------------|
| Type switch | Switch the display data type of the detail view of tool management data by pressing the button. |
| CW          | Select the [CW]. It is also selected if the value "0" is entered.                               |
| CCW         | Select the [CCW]. It is also selected if the value "1" is entered.                              |
| List view   | Switch to the tool management data list.                                                        |
| Close       | This closes the pop-up window and quits this function.                                          |

**Menus (when the cursor is at [Tool hand] of [Disp details])**

| Menus        | Details                                                                                         |
|--------------|-------------------------------------------------------------------------------------------------|
| Type switch  | Switch the display data type of the detail view of tool management data by pressing the button. |
| Right/ Front | Select the [Right/Front]. It is also selected if the value "0" is entered.                      |
| Left/ Front  | Select the [Left/Front]. It is also selected if the value "1" is entered.                       |
| Right/ Back  | Select the [Right/Back]. It is also selected if the value "2" is entered.                       |
| Left/ Back   | Select the [Left/Back]. It is also selected if the value "3" is entered.                        |
| List view    | Switch to the tool management data list.                                                        |
| Close        | This closes the pop-up window and quits this function.                                          |



**Menus (List Menus (when none of the above conditions is met))**

| Menus       | Details                                                                                         |
|-------------|-------------------------------------------------------------------------------------------------|
| Type switch | Switch the display data type of the detail view of tool management data by pressing the button. |
| List view   | Switch to the tool management data list.                                                        |
| Close       | This closes the pop-up window and quits this function.                                          |





## 6.5.4 Registering New Tool Management Data

**Operation method**

- |                                                                                                                                                 |                                                                                   |                                                                                                                                              |
|-------------------------------------------------------------------------------------------------------------------------------------------------|-----------------------------------------------------------------------------------|----------------------------------------------------------------------------------------------------------------------------------------------|
| (1) Display the tool management screen.                                                                                                         |  | The tool management data list is displayed.                                                                                                  |
| If the details of tool management data is already displayed, press the menu [List view] and switch to the display of tool management data list. |                                                                                   |                                                                                                                                              |
| (2) Use the [↑] or [↓] key to select the data number, which the tool No. is not specified yet.                                                  |                                                                                   |                                                                                                                                              |
| (3) Press the [INPUT] key.                                                                                                                      |                                                                                   |                                                                                                                                              |
| (4) Input the tool number.<br>100 [INPUT]                                                                                                       |  | The tool management data of tool number 100 is registered in the selected data number, and the cursor is shifted to the next lower position. |

## 6.5.5 Switching the Item Type of the Tool Management Data Detailed Portion

**Operation method**

- |                                                                                   |                                                                                     |                                                                                                                                                                                                                                                                                                                                                                                                                                               |
|-----------------------------------------------------------------------------------|-------------------------------------------------------------------------------------|-----------------------------------------------------------------------------------------------------------------------------------------------------------------------------------------------------------------------------------------------------------------------------------------------------------------------------------------------------------------------------------------------------------------------------------------------|
| (1) Display the tool management screen.                                           |    | The tool management data list is displayed.                                                                                                                                                                                                                                                                                                                                                                                                   |
| (2) Use the [↑] or [↓] key to select the data number to be displayed its details. |                                                                                     |                                                                                                                                                                                                                                                                                                                                                                                                                                               |
| (3) Press the [INPUT] key.                                                        |                                                                                     |                                                                                                                                                                                                                                                                                                                                                                                                                                               |
| (4) Press the menu [Type switch].                                                 |  | <p>Each time you press the menu, the item type shown in the detailed view is switched in the following sequence. "Full view" -&gt; "Custom" (*1) -&gt; "Basic info" -&gt; "Shape info" -&gt; "Cut cond." -&gt; "Offset" -&gt; "T-life" -&gt; "Added info" (*2) -&gt; "Full view".</p> <p>The cursor is moved to the top of the tool management data detail view. The selected type is maintained even after the power is turned ON again.</p> |

(\*1) The type "Custom" is skipped if there is no setting by MTB.

(\*2) If the machine parameter "#1445 Tol-Custom-nondisp" (Hide added info on tool management screen) is set to "1", the "Added info" type is skipped and it is switched to the next type.

## 6.5.6 Displaying Data by Designating Tool Management Data No.



There are two methods to switch the display from the designated tool management data number. You can switch the operation by using the "#8975 No. search process" parameter.

**Operation method**

(Example 1) Select data number 12. ("#8975 No. search process" is "0")

- (1) Display the tool management screen.  The tool management data list is displayed.
- (2) Press the menu [Manage. No. search].
- (3) Enter the tool management data number to display, and press the [INPUT] key.  
12 [INPUT]

(Example 2) Select data number 12. ("#8975 No. search process" is "1")

- (1) Display the tool management screen.  The tool management data list is displayed.
- (2) Enter the tool management data number to be displayed.  
12
- (3) Press the menu [Manage. No. search].  The specified data number is displayed at the top, and the cursor is located onto the first data.

**Note**



- (1) If a data number exceeding the limit is designated, the operation message "Setting error" is displayed.

## 6.5.7 Displaying Data by Designating Tool No.

**Operation method ("#8975 No. search process" is "0")**

The designated tool number is searched from the tool management data under the cursor position, and the tool number is displayed at the top when it is found. If the designated tool number is not found until the end of the tool management data, the search is performed from the head.

(Example) Search data number 12.

- |                                                                                                |                                                                                   |                                                                                                                                                                                                                                                                                                                                                                                                              |
|------------------------------------------------------------------------------------------------|-----------------------------------------------------------------------------------|--------------------------------------------------------------------------------------------------------------------------------------------------------------------------------------------------------------------------------------------------------------------------------------------------------------------------------------------------------------------------------------------------------------|
| (1) Display the tool management screen.                                                        |  | The tool management data list is displayed.                                                                                                                                                                                                                                                                                                                                                                  |
| (2) Press the menu [Tool No. search].                                                          |                                                                                   |                                                                                                                                                                                                                                                                                                                                                                                                              |
| (3) Enter the tool management data number to display, and press the [INPUT] key.<br>12 [INPUT] |  | After the search is completed, the operation message "Search complete" appears.<br>The input column is cleared.<br>The designated tool number is searched from the tool management data under the cursor position, and first-found tool management data is displayed at the top.<br>The cursor is shifted to the head line of the display.<br>The highlight of the menu [Tool No. search] returns to normal. |

**Note**

- (1) If the tool number cannot be found, the message "Designated tool number not found" is displayed, and the input section is not cleared.



**Operation method ("#8975 No. search process" is "1")**

(Example) Search tool number 12.

The designated tool number is searched from the tool management data under the cursor position, and the tool number is displayed at the top when it is found. If the designated tool number is not found until the end of the tool management data, the search is performed from the head.

When you press the menu [Tool No. search] again after the search is completed, the search restart for the previously searched tool No.

The previously searched tool number is maintained until the tool management screen is closed, or the display is switched to the detailed view.

- |                                                      |                                                                                     |                                                                                                                                                                                                                                                                                                                                            |
|------------------------------------------------------|-------------------------------------------------------------------------------------|--------------------------------------------------------------------------------------------------------------------------------------------------------------------------------------------------------------------------------------------------------------------------------------------------------------------------------------------|
| (1) Display the tool management screen.              |  | The tool management data list is displayed.                                                                                                                                                                                                                                                                                                |
| (2) Enter the tool number you wish to display.<br>12 |                                                                                     |                                                                                                                                                                                                                                                                                                                                            |
| (3) Press the menu [Tool No. search].                |  | After the search is completed, the operation message "Search complete" appears.<br>The input column is cleared.<br>The designated tool number is searched from the tool management data under the cursor position, and first-found tool management data is displayed at the top.<br>The cursor is shifted to the head line of the display. |

- (4) Press the menu [Tool No. search] again.

The search restart for the previously searched tool No. After the search is completed, the operation message "Search complete" appears. The input column is cleared. The designated tool number is searched from the tool management data under the cursor position, and first-found tool management data is displayed at the top. The cursor is shifted to the head line of the display.



### Note

- (1) If the tool number cannot be found, the message "Designated tool number not found" is displayed, and the input section is not cleared.

## 6.5.8 Sorting the Data by Tool No.

Sort the tool management data in ascending order of tool numbers.

### Operation method

- |                                         |                                                                                     |                                                                                                                                                                                                                                                                                                                                                                                                                           |
|-----------------------------------------|-------------------------------------------------------------------------------------|---------------------------------------------------------------------------------------------------------------------------------------------------------------------------------------------------------------------------------------------------------------------------------------------------------------------------------------------------------------------------------------------------------------------------|
| (1) Display the tool management screen. |    | The tool management data list is displayed.                                                                                                                                                                                                                                                                                                                                                                               |
| (2) Press the menu [Tool No sort].      |                                                                                     |                                                                                                                                                                                                                                                                                                                                                                                                                           |
| (3) Press the [Y] or [INPUT] key.       |  | The operation message "Sorting of tool data is in progress" flashes during tool data sorting. The operation message "Sorting of tool data is complete" is displayed after the tool data has been sorted. The tool management data is sorted in ascending order of tool numbers, and they are displayed from the beginning. The cursor moves to the top line. The highlight of the menu [Tool No. sort] returns to normal. |



### Note

- (1) During data sorting in ascending order of tool numbers, you cannot stop this sorting on the way.
- (2) Once you have sorted the data in ascending order of tool numbers, you cannot return them to the previous sort order.
- (3) If the same tool number is found multiple times, data is sorted in the order in which they are found from the top.
- (4) If no tool number is set and if data is sorted, that line is skipped during display.
- (5) The tool data is sorted for the currently displayed part system.
- (6) During data sorting, you cannot operate on the screen. Operate the screen after data sorting.



## 6.5.9 Deleting the Tool Management Data

**Deleting the tool management data in [List view]**

■Method 1: Delete the tool management data of the cursor line.

- (1) Display the tool management screen.  The tool management data list is displayed.
- (2) Use the [↑] or [↓] key to move the cursor onto the line to be deleted.
- (3) Delete the selected data.  
Menu [Tool clear] [INPUT]
- (4) Press the [Y] or [INPUT] key.  Press any key except [Y] and [INPUT] keys to cancel.  
To cancel the erasing, press a key other than [Y] or [INPUT]. Once deleted, the data is empty.



■Method 2: Delete the tool management data of the designated line.

- (1) Display the tool management screen.  The tool management data list is displayed.  
  
If the details of tool management data is displayed, press the menu [List view] and switch to the display of tool management data list.
- (2) Press the menu [Tool clear].
- (3) Specify the line clear range, by separating the first and last data numbers by a slash (/) from each other, and press the [INPUT] key.  
1/5 [INPUT]  
To delete data down to the last line, set "E".  
(Example) 5/E:
- (4) Press the [Y] or [INPUT] key.  The tool management data, that corresponds to the designated data number, is cleared and highlight of the menu display is released.  
To cancel the erasing, press a key other than [Y] or [INPUT]. Data of the cleared range is empty.

**Note**

- (1) If a value outside of the clear range is specified, the operation message "Setting error" is displayed.

**Deleting the tool management data in [Disp details]**



- (1) Display the tool management screen.  The tool management data list is displayed.  
 If the details of tool management data is displayed, press the menu [Disp details] and switch to the display of tool management data list.
- (2) Use the [↑] or [↓] key to move the cursor onto the tool number.
- (3) Delete the selected data.  
 Menu [Tool clear]  
 The menu [Tool clear] is displayed only when the cursor is located on the tool number.
- (4) Press the [Y] or [INPUT] key.  The tool management data, that is displayed in the detailed view of tool management data, is erased.  
 To cancel the erasing, press a key other than [Y] or [INPUT].

**Note**

- (1) If you wish to change the tool data to be deleted, locate the cursor onto the tool management data list and select a tool data again.

## 6.5.10 Copying and Pasting the Tool Management Data

**Operation method**

- (1) Display the tool management screen.  The tool management data list is displayed.
- (2) Use the [↑] or [↓] key to move the cursor onto the line to be copied.
- (3) Press the menu [Line copy].
- (4) Use the [↑] or [↓] key to move the cursor onto the line to be pasted.
- (5) Press the menu [Line paste].  The copied data is written in the line at the cursor position.  
 The highlighted copy line is released.

**Note**

- (1) Once data is copied, it is held until the next tool management data is copied or until the tool management screen is closed.
- (2) For tool life management I, you cannot paste to the data that does not have the tool number. It causes a paste error.

(3) The following information is not copied or pasted.

×: Not copied or pasted

| Display data       | Common |
|--------------------|--------|
| Tool shape drawing | ×      |

×: Not copied or pasted    -: Not managed

| Display data (Life data) |                | M system                  |                          | L system               |                         |
|--------------------------|----------------|---------------------------|--------------------------|------------------------|-------------------------|
|                          |                | Tool life management I/II | Tool life management III | Tool life management I | Tool life management II |
| Life                     | Status         | ×                         | ×                        | -                      | ×                       |
|                          | Method         | ×                         | ×                        | -                      | ×                       |
|                          | H No.          | ×                         | ×                        | -                      | -                       |
|                          | L offset       | ×                         | ×                        | -                      | -                       |
|                          | D No.          | ×                         | ×                        | -                      | -                       |
|                          | R offset       | ×                         | ×                        | -                      | -                       |
|                          | Aux.           | ×                         | ×                        | -                      | -                       |
|                          | Offset num     | -                         | -                        | -                      | ×                       |
|                          | Life           | ×                         | ×                        | -                      | ×                       |
|                          | Used           | ×                         | ×                        | -                      | ×                       |
|                          | Operating time | -                         | -                        | ×                      | -                       |
|                          | Life time      | -                         | -                        | ×                      | -                       |
|                          | T usage count  | -                         | -                        | ×                      | -                       |
|                          | T life count   | -                         | -                        | ×                      | -                       |
|                          | Status A       | -                         | -                        | ×                      | -                       |
| Status B                 | -              | -                         | ×                        | -                      |                         |

×: Not copied or pasted    -: Not managed

| Display data (Compensation data) |                                 | Tool compensation type I | Tool compensation type II | Tool compensation type III |          |
|----------------------------------|---------------------------------|--------------------------|---------------------------|----------------------------|----------|
|                                  |                                 |                          |                           | L system                   | M system |
| Compensation                     | Length                          | ×                        | ×                         | -                          | ×        |
|                                  | L wear                          | -                        | ×                         | -                          | ×        |
|                                  | Radius                          | -                        | ×                         | -                          | ×        |
|                                  | R wear                          | -                        | ×                         | -                          | ×        |
|                                  | Tool L offset num               | -                        | -                         | ×                          | -        |
|                                  | Wear offset #                   | -                        | -                         | ×                          | -        |
|                                  | Length 1st axis name            | -                        | -                         | ×                          | -        |
|                                  | Length 2nd axis name            | -                        | -                         | ×                          | -        |
|                                  | Length additional axis name     | -                        | -                         | ×                          | -        |
|                                  | Length 2nd additional axis name | -                        | -                         | ×                          | -        |
|                                  | Wear 1st axis name              | -                        | -                         | ×                          | -        |
|                                  | Wear 2nd axis name              | -                        | -                         | ×                          | -        |
|                                  | Wear additional axis name       | -                        | -                         | ×                          | -        |
|                                  | Wear 2nd additional axis name   | -                        | -                         | ×                          | -        |
|                                  | Nose R                          | -                        | -                         | ×                          | -        |
|                                  | R-wear                          | -                        | -                         | ×                          | -        |
|                                  | Point                           | -                        | -                         | ×                          | -        |
|                                  | Side-cut                        | -                        | -                         | ×                          | -        |
|                                  | End-cut                         | -                        | -                         | ×                          | -        |

## 6.5.11 Specifying Display Format and Setting Range of Additional Information

The display format and setting range of additional information can be changed by entering tool data file (TOOLALL.DAT) described in the specified format.

[Setting]

| No. | Addresses | Details          | Data range (Meaning)                                                                                                                                                                                                                                                                                                                                                                                                                                                                                | Supplement                                                                                                                                                                                                                                                                                                                                             |
|-----|-----------|------------------|-----------------------------------------------------------------------------------------------------------------------------------------------------------------------------------------------------------------------------------------------------------------------------------------------------------------------------------------------------------------------------------------------------------------------------------------------------------------------------------------------------|--------------------------------------------------------------------------------------------------------------------------------------------------------------------------------------------------------------------------------------------------------------------------------------------------------------------------------------------------------|
| 1   | N         | Custom data No.  | 1 to 12                                                                                                                                                                                                                                                                                                                                                                                                                                                                                             | Custom 1 to 12                                                                                                                                                                                                                                                                                                                                         |
| 2   | B         | Number of bytes  | 0: 4 bytes<br>1: 1 bytes<br>2: 2 bytes<br>4: 4 bytes                                                                                                                                                                                                                                                                                                                                                                                                                                                |                                                                                                                                                                                                                                                                                                                                                        |
| 3   | K         | Type             | 0: Signed decimal<br>1: Unsigned decimal<br>2: Hexadecimal<br>3: Bit<br>4: With decimal point (fixed number of digits)<br>5: With decimal point (linked with iunit and I_inch)<br>6: With decimal point (linked with iunit)<br>7: With decimal point (linked with I_inch)<br>8: Character string                                                                                                                                                                                                    | <ul style="list-style-type: none"> <li>•Data with decimal point is valid only when it is 4 bytes and digits information is required.</li> <li>•Character string is valid only when it is 4 bytes.</li> </ul>                                                                                                                                           |
| 4   | D         | Number of digits | 0, 11 to 88<br>If the data is without decimal point, it is set to "0" is set.<br>High-order is the number of digits of integer part<br>Low-order is the number of fraction part<br><Note><br>•Designate the data so that the total of fraction and integer part does not exceed 10 digits.                                                                                                                                                                                                          | <ul style="list-style-type: none"> <li>•When the display data is linked with iunit and I_inch, the number of digits when iunit = B and I_inch = 0 (mm) is set.</li> <li>•When I_inch = 0 (inch), the integer part decreases 1 digit and the fraction part increases 1 digit.</li> <li>•When iunit = C, the fraction part increases 1 digit.</li> </ul> |
| 5   | L         | Maximum value    | Specify the configurable maximum value and minimum value.                                                                                                                                                                                                                                                                                                                                                                                                                                           |                                                                                                                                                                                                                                                                                                                                                        |
| 6   | S         | Minimum value    | In case a check is not necessary, set that minimum value is larger than maximum value.<br>When the kind is character string, the number of characters shall be 0 to 4.<br>When the data with decimal point is selected for the kind, eliminate the decimal point from the value when iunit = B, and I_inch = 0 (mm).<br>(Example 1) In case of 0.000 to 99.999<br>Minimum value: 0, Maximum value: 99999<br>(Example 2) In case of -99.999 to 10.000<br>Minimum value: -99999, Maximum value: 10000 |                                                                                                                                                                                                                                                                                                                                                        |

### Note

(1) When the illegal value is set, it is handled as 4 bytes, signed decimal data without range check.

[Setting example]

```
N1B1K0D0L100S-100
N2B0K4D33L999999S-999999
```



## 6.6 Tool Life Management



This function manages the tool life by monitoring the cumulative cutting hours and the cumulative number of cuttings. The tool which reaches the end of its tool life can be exchanged at proper timing, this realizes uniform quality machining. Tool life information (the estimated tool life, the estimated number of cuttings, etc.) can be registered on the tool life management screen.

The tool life management function is enabled when the parameter "#1103 TLife" is set to "1"

There are some types of the tool life management method, two for M system and three for L system. It depends on the MTB specifications which type is to be selected. (The setting can be switched by the parameter "#1096 T\_Ltyp")

| Setting value of #1096 | Machining center system (M system) | Lathe system (L system) |
|------------------------|------------------------------------|-------------------------|
| 1                      | Tool life management I             | Tool life management I  |
| 2                      | Tool life management II            | Tool life management II |
| 3                      | Tool life management III           | (*1)                    |

(\*1) When "3" is set for L system, the tool life management I is applied.

For details of the respective management types, refer to "6.6.1 Tool Life Management (M System)" and "6.6.2 Tool Life Management (L System)".

Tool life management screen

| Group No. |          |    |      |      |      |       |      |       |  |
|-----------|----------|----|------|------|------|-------|------|-------|--|
| #         | Tool No. | ST | Mthd | HNo. | DNo. | Auxil | Life | Used  |  |
| 1         | 1        | 02 | 002  | 1    | 1    | 0     | 25   | 25set |  |
| 2         | 2        | 00 | 000  | 2    | 2    | 0     | 60   | 0min  |  |
| 3         |          |    |      |      |      |       |      |       |  |

Sets estimated tool life hours, estimated number of cuttings, etc.

Machining program

```
T01M06
G43G01Z50.0H1
.....
```

T command (Tool command)

Updates tool life status such as cumulative cutting hours and cumulative number of cuttings

Tool life management function  
Counts the actual data (cutting hours and the number of cuttings).  
Checks that the spindle tool reaches the end of its tool life.

## 6.6.1 Tool Life Management (M System)

Select a type of the tool life management and register the tool life data, and then issue the T command (tool command) to start the tool life management.

■ Selecting the tool life management type

Features of the respective tool life managements are described in the table below.

| Type | Feature                                                                                                                                                                                                  | Group registration           | Tool selection                                                                  |
|------|----------------------------------------------------------------------------------------------------------------------------------------------------------------------------------------------------------|------------------------------|---------------------------------------------------------------------------------|
| I    | The usage of a tool commanded by the machining program is monitored.                                                                                                                                     | Available                    | Selected by the T command (tool command) directly                               |
| II   | Command a group No./a tool No. to which the same type of the tool is registered by the machining program, and the corresponding tool is automatically selected from the group to monitor its usage. (*1) | Available                    | Selected from the group automatically (Automatic spare tool selection function) |
| III  | The usage of a tool commanded by the machining program is monitored.                                                                                                                                     | Not available (Group 1 only) | Selected by the T command (tool command) directly                               |

(\*1) The setting to handle the tool command (as the group No. or the tool No.) is specified by the parameter "#1104 T\_Com2".



The method to select the tool from the group (in the order of the tool registration or of the length of the remaining tool life) is specified by the parameter "#1105 T\_Sel2".

■ Registering the tool life data

Register the tool life data which is to be used on the tool life management screen. The tool life data is set by the estimated tool life (hours) or by the estimated number of cuttings.

6.6.1.1 Registering Tool Life Management Data on the Group Unit Display Screen

You can register the tool life management data on this screen. The tool usage is displayed on this screen. Press the menu [T-life group] to change to this screen when the group list is displayed.

Use the  or  key to scroll the screen if all the registered tools cannot be displayed in the display area of the screen. This screen is common to the tool life managements I, II and III.

<Normal display>

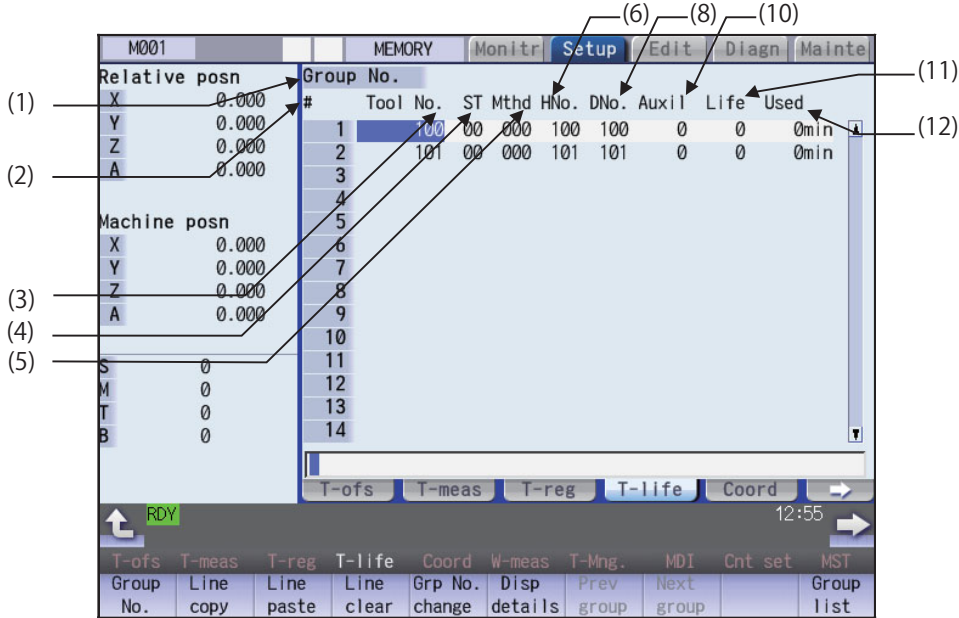

<Detailed display>

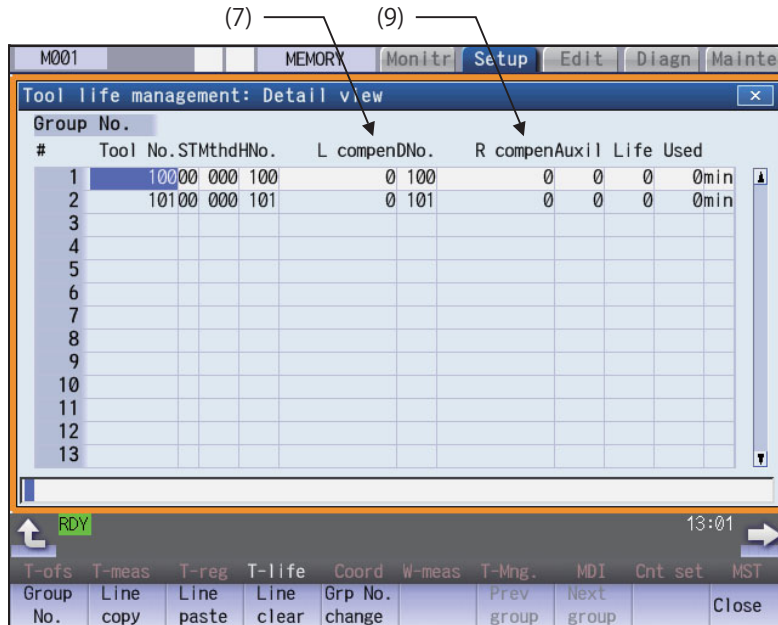

**Note**

(1) When the part system is changed while the data is being edited on the group unit display screen, the editing data will be discarded. To display the group unit of the changed part system, return to the group list display screen first and then display the group unit display screen again.

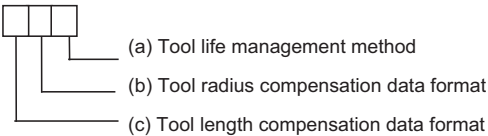
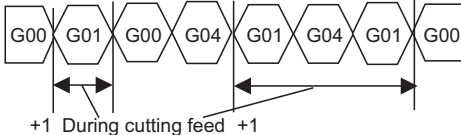
| Display items |                                                                                                                                                                                                                                                                                                                                                                                                                                                                                                                                                                                                                                                                                                                                                                                                                                                                                                                                                                                                                                                                                                                                                                                                                                                                                                                                                                                                                                                                                               |               |
|---------------|-----------------------------------------------------------------------------------------------------------------------------------------------------------------------------------------------------------------------------------------------------------------------------------------------------------------------------------------------------------------------------------------------------------------------------------------------------------------------------------------------------------------------------------------------------------------------------------------------------------------------------------------------------------------------------------------------------------------------------------------------------------------------------------------------------------------------------------------------------------------------------------------------------------------------------------------------------------------------------------------------------------------------------------------------------------------------------------------------------------------------------------------------------------------------------------------------------------------------------------------------------------------------------------------------------------------------------------------------------------------------------------------------------------------------------------------------------------------------------------------------|---------------|
| Display items | Details                                                                                                                                                                                                                                                                                                                                                                                                                                                                                                                                                                                                                                                                                                                                                                                                                                                                                                                                                                                                                                                                                                                                                                                                                                                                                                                                                                                                                                                                                       | Setting range |
| (1) Group No. | This is the group No. of the tool which is subject to the tool life management. (*1)<br>Tools with the same group No. are regarded as spare tools.                                                                                                                                                                                                                                                                                                                                                                                                                                                                                                                                                                                                                                                                                                                                                                                                                                                                                                                                                                                                                                                                                                                                                                                                                                                                                                                                            | 1 to 99999999 |
| (2) #         | This is the data setting No. This is not the magazine pot No.                                                                                                                                                                                                                                                                                                                                                                                                                                                                                                                                                                                                                                                                                                                                                                                                                                                                                                                                                                                                                                                                                                                                                                                                                                                                                                                                                                                                                                 |               |
| (3) Tool No.  | This is the No. corresponding to the each individual tool. Maximum 1000 tools can be registered.<br>This is a fixed tool No. actually output for the tool command and so on.                                                                                                                                                                                                                                                                                                                                                                                                                                                                                                                                                                                                                                                                                                                                                                                                                                                                                                                                                                                                                                                                                                                                                                                                                                                                                                                  | 1 to 99999999 |
| (4) ST        |  <p>Tool status<br/>0: Unused tool<br/>Normally set to "0" when the tool is replaced with a new tool.<br/>1: Tool in use<br/>This becomes "1" when the cutting actually starts.<br/>2: Normal life tool<br/>This becomes "2" when the usage data (usage time and No. of uses) exceeds the life data.<br/>3: Abnormal tool 1 (*2)<br/>4: Abnormal tool 2 (*2)</p>                                                                                                                                                                                                                                                                                                                                                                                                                                                                                                                                                                                                                                                                                                                                                                                                                                                                                                                                                                                                                                             |               |
| (5) Mthd      |  <p>(a) Tool life management method<br/>0: Cumulative cutting hours<br/>This is the method to manage by the actual cutting time.<br/>1: Cumulative number of mounting times<br/>This is the method to manage by the number of times the tool is treated as a spindle tool at the tool change etc. However, when no cutting feed command (G01, G02, G03 etc.) is issued for the spindle tool, the number of mounting times is not counted.<br/>2: Cumulative number of cuttings<br/>This is the method to manage by counting the number of times when the rapid traverse command (G00 etc.) is changed to the cutting feed command (G01, G02, G03 etc.). However, a rapid traverse or a cutting feed command with no movement is not counted.</p>  <p>(b) Tool radius compensation data format<br/>(c) Tool length compensation data format<br/>0: Compensation number format<br/>1: Incremental compensation format<br/>2: Direct compensation format<br/>Displays the length dimension or radius dimension of the tool compensation amount of the compensation number designated by "HNo." or "DNo." in the display item "L compen" or "R compen".<br/>If the value of the display item "L compen" or "R compen" is changed, the length dimension or radius dimension of the tool compensation amount is rewritten.</p> |               |

| Display items | Details                                                                                                                                                                                                                                                                                                                                               | Setting range                                                                |
|---------------|-------------------------------------------------------------------------------------------------------------------------------------------------------------------------------------------------------------------------------------------------------------------------------------------------------------------------------------------------------|------------------------------------------------------------------------------|
| (6) HNo.      | Length compensation number.<br>Entering a new tool number automatically assigns the same compensation number as the tool number.<br>If a new tool number is entered that is outside the allowable compensation number range, the compensation number is assigned to "0".<br>The compensation number can also be changed to any number as needed.      | 1 to 999                                                                     |
| (7) L compen  | Length dimension of tool compensation amount of the compensation number designated by "HNo.".                                                                                                                                                                                                                                                         | (*3)                                                                         |
| (8) DNo.      | Tool radius compensation number.<br>Entering a new tool number automatically assigns the same compensation number as the tool number.<br>If a new tool number is entered that is outside the allowable compensation number range, the compensation number is assigned to "0".<br>The compensation number can also be changed to any number as needed. | 1 to 999                                                                     |
| (9) R compen  | Radius dimension of tool compensation amount of the compensation number designated by "DNo.".                                                                                                                                                                                                                                                         | (*3)                                                                         |
| (10) Aux.     | This depends on the MTB specifications.                                                                                                                                                                                                                                                                                                               | 0 to 65535                                                                   |
| (11) Life     | Set the tool life for each tool to this column based on the format set in the "Mthd" column, selecting from the cutting time (minutes), the number of mounting times (to spindle), or the number of cuttings (holes to be drilled).<br>The tool life is infinite when "0" is set.                                                                     | Cutting time: 0 to 4000 (min.)<br>Number of mounting times: 0 to 65000 (set) |
| (12) Used     | This displays the usage data for each tool based on the method specified for the tool life management method.                                                                                                                                                                                                                                         | Number of cuttings: 0 to 65000 (set)                                         |

(\*1) The group No. is not displayed for the tool life management III.

(\*2) This depends on the MTB specifications.

(\*3) The "L compen" and "R compen" calculation/direct compensation amount setting/display range are as follows based on a combination of settings of "#1003 iunit" (input unit) and "#1041 Initial inch".

| #1003 iunit | #1041 I_inch | Setting range               |
|-------------|--------------|-----------------------------|
| B           | 0            | -9999.999 to 9999.999       |
|             | 1            | -999.9999 to 999.9999       |
| C           | 0            | -9999.9999 to 9999.9999     |
|             | 1            | -999.99999 to 999.99999     |
| D           | 0            | -9999.99999 to 9999.99999   |
|             | 1            | -999.999999 to 999.999999   |
| E           | 0            | -9999.999999 to 9999.999999 |
|             | 1            | -999.9999999 to 999.9999999 |

When the input value is set to the one without decimal point, the setting unit follows to the parameter "#8119 Comp. unit switch".

The tool compensation amount to be displayed by "L compen" and "R compen" are switched depending on the tool compensation type as follows:

| Tool compensation type | Item     | Setting range                                                                                               |
|------------------------|----------|-------------------------------------------------------------------------------------------------------------|
| I                      | L compen | The compensation amount that is set in the designated compensation number                                   |
|                        | R compen |                                                                                                             |
| II                     | L compen | The compensation amount that is set in the length of the designated compensation number                     |
|                        | R compen | The compensation amount that is set in the radius of the designated compensation number                     |
| III                    | L compen | The compensation amount that is set in the Z axis of tool length data of the designated compensation number |
|                        | R compen | The compensation amount that is set in nose R of the designated compensation number                         |

**Note**

(1) The tool usage data is not counted in the following cases even when the tool life management is valid.

- ♦The value of "Life" is "0".
- ♦The display of "ST" is "2" (Normal life tool).  
Only when the parameter "#1259 set31/bit0" is set to "0". (\*1)
- ♦The display of "ST" is "3" (Abnormal tool 1) or "4" (Abnormal tool 2).
- ♦Miscellaneous function lock
- ♦Dry run
- ♦Single block
- ♦Skip
- ♦Graphic check
- ♦When the automatic machine lock signal is being input at least for one axis.  
If the automatic machine lock signal is turned ON at the middle of the program, the tool usage data is counted on the block where the signal is turned ON. However, the data will not be counted on the subsequent blocks.

(\*1) When the parameter "#1259 set31/bit0" is set to "1" and, the usage data is counted until when it reaches the maximum value indicated below even if the display of "ST" is "2" (Normal life tool).

Cutting time: 4000 minutes

Number of cuttings: 65000 sets

**Menus**

| Menus          | Details                                                                                                                                                                                                                                                                                                                            |
|----------------|------------------------------------------------------------------------------------------------------------------------------------------------------------------------------------------------------------------------------------------------------------------------------------------------------------------------------------|
| Group No.      | This displays the data of a group when that group No. of tool life management data is set and the [INPUT] key is pressed. (*1)<br>The group No. can be referred to in the group list.                                                                                                                                              |
| Line copy      | Copies one line of tool life management data where the cursor is located.                                                                                                                                                                                                                                                          |
| Line paste     | The copied tool life management data is written to the data in the line where the cursor is located.<br>If the data is changed after the menu [Line copy] is pressed, the data before change (at the time when the menu [Line copy] is pressed) is pasted.<br>The copied data can be pasted repeatedly until a new data is copied. |
| Line clear     | This deletes the designated tool life management data.<br>The range to be deleted can be specified. Specify the range with the first line No. and the last line No. separated by "/".<br>If the [INPUT] key is pressed without specifying a line, the data in the line where the cursor is located is erased.                      |
| Grp No. change | This changes a group No. (*1)<br>If a new group No. is set and the [INPUT] key pressed, the group No. changes.<br>An error occurs if an existing group No. is specified.                                                                                                                                                           |
| Disp details   | Displays the pop-up window for details of the selected group.                                                                                                                                                                                                                                                                      |
| Prev group     | Displays the previous group No. data. (*1)                                                                                                                                                                                                                                                                                         |
| Next group     | Displays the next group No. data. (*1)                                                                                                                                                                                                                                                                                             |
| Group list     | This displays the list of tool life data groups. (*1)                                                                                                                                                                                                                                                                              |
| Group regist   | This creates a new group. (*2)                                                                                                                                                                                                                                                                                                     |
| Group delete   | This deletes all tool life management data contained in the currently displayed group No. (*2)                                                                                                                                                                                                                                     |
| Close          | This closes the pop-up window for details of the selected group.                                                                                                                                                                                                                                                                   |

(\*1) This menu is not valid for the tool life management III.

(\*2) This menu is not displayed for the tool life management III.

**Operation method (Designating a group No.)**

- (1) Press the menu [Group No.].
- (2) Enter the group number to be displayed in the input area, and press the [INPUT] key.

**Note**

- (1) If a group No. that does not exist is designated, a message appears to confirm the creation of a new No. A new group is created if [Y] or [INPUT] is pressed.



**Operation method (Changing a group No.)**

- (1) Press the menu [Grp No.change].
- (2) Enter the group number to be replaced in the input area, and press the [INPUT] key.

**Note**

- (1) An error occurs if the group No. duplicates a pre-existing group No.

**Operation method (Setting the tool life management data)**

- (1) Move the cursor to the data to be set using the , , [↑], [↓], [←] or [→] key.  
It is possible to move to the line after the registered line.  
Set a tool No. for this line to newly register tool life management data.
- (2) Set the tool life management data in the input area, and press the [INPUT] key.

**Note**

- (1) When no value is set in the status ("ST"), the setting is invalid.
- (2) The same tool cannot be registered in more than one group.
- (3) If the tool No. is not set, the other data cannot be set.
- (4) Change the "Mthd" to initialize the related items.  
When the tool life management method (the 3rd digit) is changed, the data in "Life" and "Usage" are cleared to "0", and the setting units are also changed.  
When tool radius compensation data format (the 2nd digit) is changed, the data in "R compen" is cleared to 0".  
When tool length compensation data format (the 1st digit) is changed, the data in "L compen" is cleared to 0".  
The number of digits after the decimal point is also changed depending on the specifications.

**Operation method (Copying/pasting the tool life management data)**

- (1) Move the cursor to the line to be copied.
- (2) Press the menu [Line copy].
- (3) Move the cursor to the line where the data is to be pasted.
- (4) Press the menu [Line paste].

**Note**

- (1) It is not possible to paste into a line for which a tool No. has not been set.
- (2) Once copied, the data is held until a new data item is copied.

**Operation method (Deleting the tool life management data by one line)**

- (1) Move the cursor to the line to be deleted.
- (2) Press the menu [Line clear] and [INPUT] keys.
- (3) Press the [Y] or [INPUT] key.  
Press a key other than [Y] or [INPUT] in order not to delete the data.

**Operation method (Designating and deleting the multiple lines of data)**

- (1) Press the menu [Line clear].
- (2) Set the range to be deleted by marking the first and last # Nos. with a "/".  
(Example) 122/125 [INPUT]
- (3) Press the [Y] or [INPUT] key.  
Press a key other than [Y] or [INPUT] in order not to delete the data.

**Operation method (Registering a group)**

- (1) Press the menu [Group regist].
- (2) Enter the group number to be registered in the input area, and press the [INPUT] key.

**Note**

- (1) An error occurs if the group No. duplicates a pre-existing group No.
- (2) The group is not registered if one of the operations below is performed after registering a new group No.
  - When you quit this operation without registering even 1 item of the tool life management data.
  - When the screen is changed to that of other than the group unit display.
  - When the part system is changed.

**Operation method (Deleting a group)**

- (1) Move the cursor to the group No. to be deleted.
- (2) Press the menu [Group delete] and [INPUT] key.
- (3) Press the [Y] or [INPUT] key.



## 6.6.1.2 Operation Descriptions (Tool life management I/III)

The tool No. which is to be used is specified by T command with this management type.

A tool which is mounted to the spindle by the tool change command (M06) is subject to the tool life management.

The tool usage is monitored based on the tool life management method (cumulative cutting hours, cumulative number of mounting times or cumulative number of cuttings) which is set in the "Mthd" column on the group unit display screen.

When the use of the tool is started, "1" which indicates the status of "Tool in use" is displayed in the "ST" column. The cumulative cutting hours (or the cumulative number of cuttings) is displayed in the "Used" column.

When the cumulative cutting hours (or the cumulative number of cuttings) has reached the value set in the "Life" column, the display of the "ST" column changes to "2" which indicates the status of "Normal life tool".

[Display example of the "Mthd" column on the group unit display screen]

When "0" (management by the cumulative cutting hours) is set for the tool life management method, and the tool of No. 2 has been used for one minute.

| Group No. |          | 1  |      |      |      |       |      |      |  |
|-----------|----------|----|------|------|------|-------|------|------|--|
| #         | Tool No. | ST | Mthd | HNo. | DNo. | Auxil | Life | Used |  |
| 1         | 1        | 00 | 000  | 1    | 1    | 0     | 120  | 0min |  |
| 2         | 2        | 01 | 000  | 2    | 2    | 0     | 120  | 1min |  |
| 3         |          |    |      |      |      |       |      |      |  |

### Tool compensation operation

The tool is compensated by the amount of the tool compensation No. specified by either of the following addresses in the machining program:

- Address H of the G43/G44 command (tool length compensation)
- Address D of the G41/G42 command (tool radius compensation)

The first 2 digits of "Mthd" (tool radius compensation data format/tool length compensation data format), "HNo." and "DNo." tool life management screen are not used for the tool compensation.

## 6.6.1.3 Operation Descriptions (Tool life management II)

Specify the tool to be used by issuing the T command.

Either of the following command methods can be selected for T command of the tool life management II:

- The method to designate the group No. in which the target tool is registered
- The method to designate the tool No. of the target tool

It depends on the MTB specifications which method is to be selected. (The setting can be changed by the combination of the parameters "#1104 T\_Com2" and "#1227 aux11/bit1".)

◆When the group No. is designated

This function selects a tool in accordance with the setting of the parameter "#1105 T\_sel2" from the group which is designated by the T command, and the selected tool is set to the spare tool.

◆When the tool No. is designated

This function searches the group in which the tool, whose No. is designated by the T command, is registered. And then a tool is selected in accordance with the setting of the parameter "#1105 T\_sel2" from the group, and the selected tool is set to the spare tool.

After the selected tool is mounted to the spindle by the tool change command (M06), it will be managed by the tool life management.

The tool usage is monitored based on the tool life management method (cumulative cutting hours, cumulative number of mounting times or cumulative number of cuttings) which set in the "Mthd" column on the group unit display screen. When the use of the tool is started, "1" which indicates the status of "Tool in use" is displayed in the "ST" column. The cumulative cutting hours (or the cumulative number of cuttings) is displayed in the "Used" column. When the cumulative cutting hours (or the cumulative number of cuttings) has reached the value set in the "Life" column, the display of the "ST" column changes to "2" which indicates the status of "Normal life tool".

[Display example of the group unit display screen]

When the tool of No.11 which is selected from the group 2 has been used for one minute.

| Group No. |          | 2  |      |      |      |       |      |      |  |
|-----------|----------|----|------|------|------|-------|------|------|--|
| #         | Tool No. | ST | Mthd | HNo. | DNo. | Auxil | Life | Used |  |
| 1         | 11       | 01 | 000  | 11   | 11   | 0     | 120  | 1min |  |
| 2         | 12       | 00 | 000  | 12   | 12   | 0     | 120  | 0min |  |
| 3         |          |    |      |      |      |       |      |      |  |

When the tool life management method is set "0" (management by the cumulative cutting hours) in the "Mthd" column, the display of the "Life" and the "Used" columns are based on time.

### Tool compensation operation

#### ■When the parameter "#1227 aux1/bit1" = 0

The tool compensation is performed based on the setting value of the "Mthd" on the tool management screen.

The tool compensation data is acquired from the tool compensation screen regardless of the setting of the "Mthd".

#### 0: Compensation number format

The G43/G44 command executes the compensation using the data (the tool length and the length wear) corresponding to "HNo." of the selected tool.

The G41/G42 command executes the compensation using the data (the radius dimension and the radius wear) corresponding to "DNo." of the selected tool.

#### 1: Incremental compensation format

The G43/G44 command executes the compensation using the data (the tool length and the length wear) of the compensation No. specified by the address H, by adding the data (the tool length) corresponding to "HNo." of the selected tool to the said data.

The G41/G42 command executes the compensation using the data (the radius dimension and the radius wear) of the compensation No. specified by the address D, by adding the data (the radius dimension) corresponding to "DNo." of the selected tool to the said data.

#### 2: Direct compensation format

The G43/G44 command executes the compensation using the data (the tool length) corresponding to "HNo." of the selected tool.

The G41/G42 command executes the compensation using the data (the radius dimension) corresponding to "DNo." of the selected tool.

### Note

(1) The value specified by the address H of the G43/G44 command or the address D of the G41/G42 command is not used in the compensation number format or the direct compensation format.

#### ■When the parameter "#1227 aux1/bit1" = 1

The tool compensation operation varies as follows depending on the value of the address H or the address D.

| Condition                                             | Tool compensation operation                                                                                                                                 |
|-------------------------------------------------------|-------------------------------------------------------------------------------------------------------------------------------------------------------------|
| Address H of the G43/G44 command is "H99".            | The G43/G44 command executes the compensation using the data (the tool length and the length wear) corresponding to "HNo." of the selected tool.            |
| Address H of the G43/G44 command is other than "H99". | The G43/G44 command executes the compensation using the data (the tool length and the length wear) of the compensation No. specified by the address H.      |
| Address D of the G41/G42 command is "D99".            | The G41/G42 command executes the compensation using the data (the radius dimension and the radius wear) corresponding to "DNo." of the selected tool.       |
| Address D of the G41/G42 command is other than "D99". | The G41/G42 command executes the compensation using the data (the radius dimension and the radius wear) of the compensation No. specified by the address D. |



### 6.6.1.4 Registering the Tool Life Management Data Groups on the Group List Display Screen (Tool life management I/II)

Tool life management data groups can be registered and deleted.

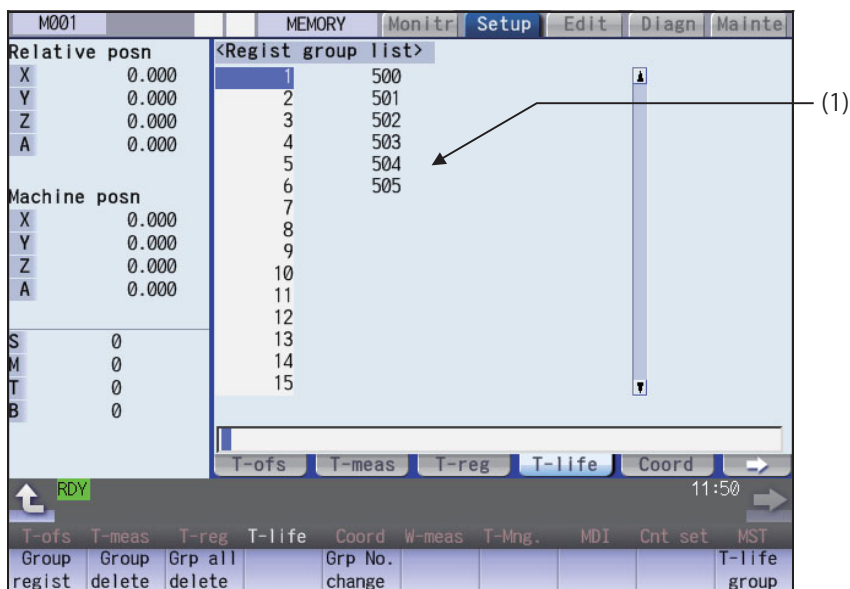

Press the menu [Group list] to change to this screen when the group unit is displayed.



#### Display items

| Display items         | Details                                                                                                                                                                                                                                                                                                                                                                                                                                                                                                                                                                                                                                                                                                                                                                                                                                                                                     |
|-----------------------|---------------------------------------------------------------------------------------------------------------------------------------------------------------------------------------------------------------------------------------------------------------------------------------------------------------------------------------------------------------------------------------------------------------------------------------------------------------------------------------------------------------------------------------------------------------------------------------------------------------------------------------------------------------------------------------------------------------------------------------------------------------------------------------------------------------------------------------------------------------------------------------------|
| (1) Regist group list | <p>The group Nos. registered as the tool life management data are listed in ascending order. Group Nos. can be set from 1 to 99999999, and maximum 1000 groups can be registered.</p> <p>Maximum 60 groups can be displayed at a time. Use the  or  key to scroll the screen if the No. of registered groups exceeds 60.</p> <p>An asterisk will be added to the No. of the group in which all tools have reached their lives.</p> <p>&lt;Note&gt;</p> <ul style="list-style-type: none"> <li>•The maximum number of the registered groups depends on the specifications.</li> <li>•In tool life management II, when all the tools' statuses (ST) of the target group become 2 to 4, "*" is displayed.</li> </ul> |

#### Menus

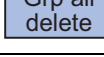
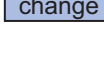
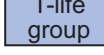
| Menus                                                                               | Details                                                                                                                                                                                                             |
|-------------------------------------------------------------------------------------|---------------------------------------------------------------------------------------------------------------------------------------------------------------------------------------------------------------------|
|  | Creates a new group and adds the group No. to the list.                                                                                                                                                             |
|  | This deletes all of the tool life management data included in the designated group No. If the group No. is not designated, the tool life management data for the group No. indicated by the cursor will be deleted. |
|  | This deletes all groups and their tool life management data registered in the part system which is currently selected.                                                                                              |
|  | This changes a group No. Specify a new group No. and press the [INPUT] key to change the group No. and then change the contents of the list. An error occurs if an existing group No. is specified.                 |
|  | The tool life management data of the group No. where the cursor is located is displayed. The tool life management data can be set and displayed on a group basis on this mode.                                      |

**Operation method (Registering a group)**

- (1) Press the menu [Group regist].
- (2) Set the No. of the group to be registered.  
(Example) 25 [INPUT]

**Note**

- (1) An error occurs if the group No. duplicates a pre-existing group No.
- (2) The group is not registered if one of the operations below is performed after registering a new group No.
  - ◆When you quit this operation without registering even 1 item of the tool life management data.
  - ◆The screen is changed to that of other than the group unit display.
  - ◆The part system is changed.

**Operation method (Deleting a group)**

- (1) Press the menu [Group delete].
- (2) Designate the group to be deleted.  The selected group No. is deleted.  
(Example) 72 [INPUT]

If nothing is input in the input area, the group at the cursor location is deleted.

**Operation method (Deleting all groups)**





- (1) Press the menu [Grp all delete].
- (2) Press the [Y] or [INPUT] key.  All the registered groups and their tool life management data is deleted.

**Note**

- (1) If no group has been registered, the operation message "Can't delete all groups" appears.



**Operation method (Changing a group No.)**

(Example) Changing the group No. from 5 to 20

- (1) Use the [↑], [↓],  or  key to move the cursor to the group No. 5.
- (2) Press the menu [Grp No.change].  The menu is highlighted.
- (3) Designate the group No. to be replaced.  The group No. changes to "20".  
20 [INPUT]

**Operation method (Changing to the group unit display)**

(Example) Displaying the tool life management data of the group No. 5.

- (1) Use the [↑], [↓],  or  key to move the cursor to the group No. 5.
- (2) Press the menu [T-life group] or [INPUT] keys.  The screen changes to the group unit display and the group No. "5" tool life management data displays.

### 6.6.2 Tool Life Management (L System)

Select a type of the tool life management and register tool life data, and then issue the T command (tool command) to start the tool life management.

#### ■Selecting the tool life management type

The tool life management I: The usage of a tool commanded by the machining program is monitored.

The tool life management II: Command a group No. in which the same type of the tool is registered by the machining program, and the corresponding tool is selected from the group to monitor its usage.

#### ■Registering the tool life data

Register the tool life data which is to be used on the tool life management screen. The tool life data is set by the estimated tool life (hours) or by the estimated number of cuttings.

#### ■Executing the tool life management

The tool life management is executed during the operation by the machining program.

T command (tool command) is issued based on the tool life management type of the tool life.

| Management type         | Command method          | Details                                           |
|-------------------------|-------------------------|---------------------------------------------------|
| Tool life management I  | Specifies the tool No.  | T ○○ΔΔ command<br>(○○: No., ΔΔ: compensation No.) |
| Tool life management II | Specifies the group No. | T □□□□99 command<br>(□□□□: group No.)             |

6.6.2.1 Registering the Tool Life Management Data (Tool Life Management I)

The tool life management data can be set and displayed.

Use the  or  key to scroll the screen if all the registered tools cannot be displayed in the display area of the screen.

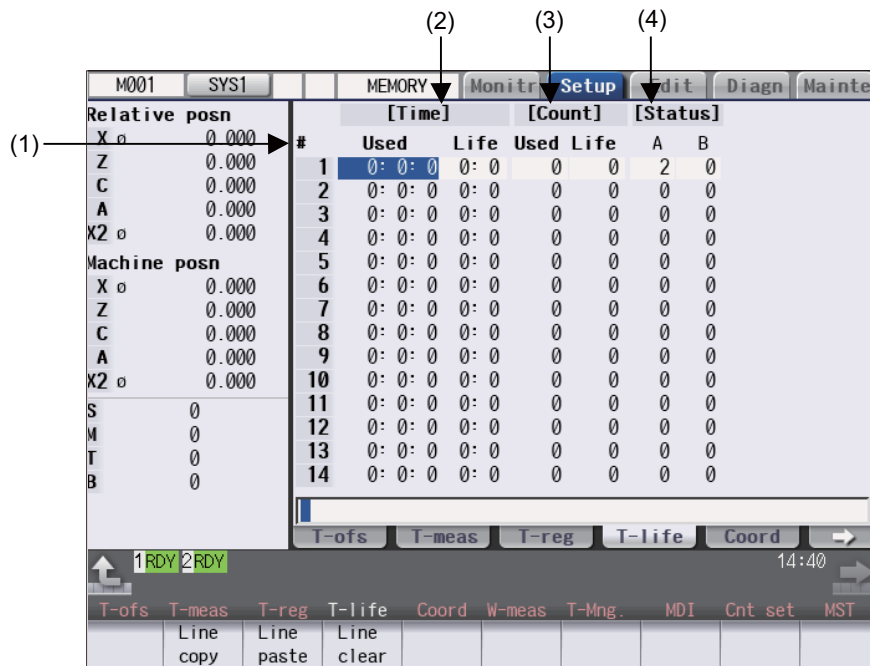



Display items

| Display items |        | Details                                                                                                                                                                                                                       | Setting range                                          |
|---------------|--------|-------------------------------------------------------------------------------------------------------------------------------------------------------------------------------------------------------------------------------|--------------------------------------------------------|
| (1)           | #      | Tool No.<br>The # No. is highlighted in the following cases.<br>- The cumulative cutting hours have reached the estimated tool life (hours).<br>- The cumulative number of cuttings exceeds the estimated number of cuttings. |                                                        |
| (2)           | Time   | Used<br>The cumulative cutting hours of the tool<br>The count goes up during cutting.                                                                                                                                         | 0:0 to 99:59 (hour:minute)                             |
|               | Life   | Setting for the estimated tool life<br>Set the estimated maximum tool life.<br>Unit of second is fixed to "0".                                                                                                                | 0:0 to 99:59 (hour:minute)<br>(0:0 = no warning given) |
| (3)           | Count  | Used<br>The cumulative number of cuttings for tool use<br>The count goes up during cutting.                                                                                                                                   | 0 to 65000 (times)                                     |
|               | Life   | Setting for estimated number of cuttings<br>Set the estimated maximum number of cuttings.                                                                                                                                     | 0 to 65000 (times)<br>(0:0 = no warning given)         |
| (4)           | Status | A<br>The tool life management status is indicated.<br>0: Not used<br>1: Current tool (tool being used)<br>2: Estimated tool life hours are exceeded.                                                                          | 0 to 2                                                 |
|               |        | B<br>(Used by MTB)                                                                                                                                                                                                            | 0 to 99                                                |

## Menus

| Menus      | Details                                                                                                                                                                                                                                                                                                                                            |
|------------|----------------------------------------------------------------------------------------------------------------------------------------------------------------------------------------------------------------------------------------------------------------------------------------------------------------------------------------------------|
| Line copy  | Copies one line of tool life management data where the cursor is located.                                                                                                                                                                                                                                                                          |
| Line paste | The copied tool life management data is written to the data in the line where the cursor is located.<br>If the data is changed after the menu [Line copy] is pressed, the data before change (at the time when the menu [Line copy] is pressed) is pasted.<br>The copied data can be pasted as many times as is required until new data is copied. |
| Line clear | This deletes the designated tool life management data.<br>The range to be deleted can be specified. Specify the range with the first line No. and the last line No. separated by "/".<br>If the [INPUT] key is pressed without specifying a line, the data in the line where the cursor is located is erased.                                      |

## Operation method (Setting the tool life management data)

- Move the cursor to the data to be set using the , , [↑], [↓], [←] or [→] key.  
It is possible to move to the line after the registered line.
- Enter the value in the input area, and then press the [INPUT] key.

## Operation method (Copying/pasting the tool life management data)

- Move the cursor to the line to be copied.
- Press the menu [Line copy].
- Move the cursor to the line where the data is to be pasted.
- Press the menu [Line paste].

**Note**

- Once copied, the data is held until a new data item is copied.

## Operation method (Deleting the tool life management data by one line)

- Move the cursor to the line to be deleted.
- Press the menu [Line clear] and [INPUT] keys.
- Press the [Y] or [INPUT] key.  
Press a key other than [Y] or [INPUT] in order not to delete the data.

**Operation method (Designating and deleting the multiple lines)**



- (1) Press the menu [Line clear].
- (2) Set the erasing range by marking the first and last # Nos. with a "/", and press the [INPUT] key.  
(Example) 122/125 [INPUT]
- (3) Press the [Y] or [INPUT] key.  
Press a key other than [Y] or [INPUT] in order not to delete the data.

**Note**

- (1) If the [INPUT] key is pressed without setting a # No., the line at the cursor is deleted.

**6.6.2.2 Registering Tool Life Management Data on the Group Unit Display Screen (Tool Life Management II)**

You can register the tool life management data on this screen. The tool usage is displayed on this screen. Press the menu [T-life group] to change to this screen when the group list is displayed.

Use the  or  key to scroll the screen if all the registered tools cannot be displayed in the display area of the screen.

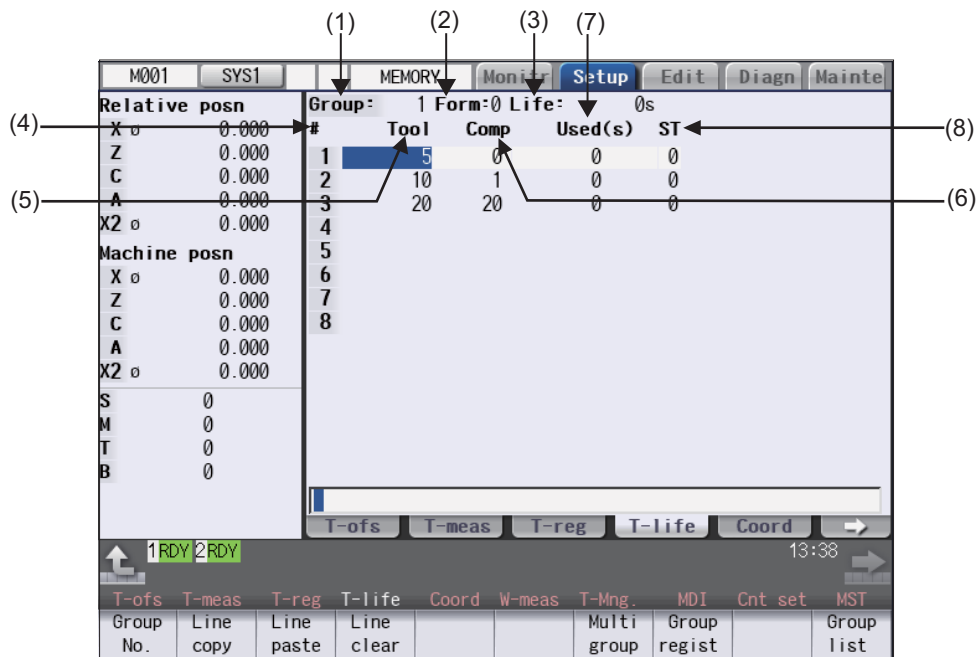



The number of groups to be displayed on a single screen depends on the setting of the parameter "#1107 Tlifsc". (This depends on the MTB specifications.)

| Setting value of #1107 | No. of display groups | Max. No. of registered tools |
|------------------------|-----------------------|------------------------------|
| 0                      | 1                     | 16                           |
| 1                      | 2                     | 8                            |
| 2                      | 4                     | 4                            |

[Display example: 4 groups are displayed on a single screen (#1107 Tlifsc = 2)]

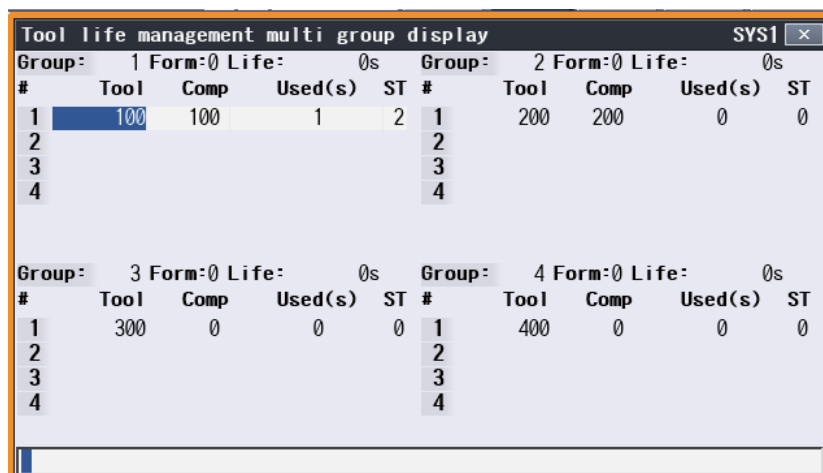

**Display items**

<Group information>

| Display items | Details                                                                                                                                                                                                                                 | Setting range                                                                              |
|---------------|-----------------------------------------------------------------------------------------------------------------------------------------------------------------------------------------------------------------------------------------|--------------------------------------------------------------------------------------------|
| (1) Group     | Life management group No.                                                                                                                                                                                                               | 1 to 9999                                                                                  |
| (2) Method    | This displays whether the group currently being displayed is managed by the cumulative cutting hours or the cumulative number of cuttings.                                                                                              | 0: Cumulative cutting hours<br>1: Cumulative number of cuttings                            |
| (3) Life      | The tool life management data for the currently displayed group is set in this column.<br>The following data and units are displayed based on the management method.<br>Estimated tool life: (s)<br>Estimated number of cuttings: (set) | Estimated tool life: 0 to 9999999 (sec)<br>Estimated number of cuttings: 0 to 999999 (set) |

<Tool Life management data in a group>

| Display items | Details                                                                                                                                                                                                                                                           | Setting range                                                                              |
|---------------|-------------------------------------------------------------------------------------------------------------------------------------------------------------------------------------------------------------------------------------------------------------------|--------------------------------------------------------------------------------------------|
| (4) #         | This displays whether the tool for which the # No. is highlighted is a life tool (ST=2) or a skip tool (ST=3).                                                                                                                                                    |                                                                                            |
| (5) Tool No.  | The tool No. is set in this column.                                                                                                                                                                                                                               | 1 to 999999                                                                                |
| (6) Comp No.  | The compensation No. is set in this column.                                                                                                                                                                                                                       | 1 to 80                                                                                    |
| (7) Used      | Estimated too life or estimated number of cuttings is set in this column. When the setting is omitted, "0" is displayed.<br>The following units for the usage data is displayed based on the management method.<br>Cutting time: (s)<br>Number of cuttings: (set) | Estimated tool life: 0 to 9999999 (sec)<br>Estimated number of cuttings: 0 to 999999 (set) |
| (8) ST        | This sets the tool status.<br>When the setting is omitted, "0" is displayed.<br>0: Unused tool<br>1: Used tool<br>2: Normal life tool<br>3: Skipped tool                                                                                                          | 0 to 3                                                                                     |

| Menus          |                                                                                                                                                                                                                                                                                                                                                    |
|----------------|----------------------------------------------------------------------------------------------------------------------------------------------------------------------------------------------------------------------------------------------------------------------------------------------------------------------------------------------------|
| Menus          | Details                                                                                                                                                                                                                                                                                                                                            |
| Group No.      | This displays the data of a group when that group No. of tool life management data is set and the [INPUT] key is pressed.<br>The group No. can be referred to in the group list.                                                                                                                                                                   |
| Line copy      | Copies one line of tool life management data where the cursor is located.                                                                                                                                                                                                                                                                          |
| Line paste     | The copied tool life management data is written to the data in the line where the cursor is located.<br>If the data is changed after the menu [Line copy] is pressed, the data before change (at the time when the menu [Line copy] is pressed) is pasted.<br>The copied data can be pasted as many times as is required until new data is copied. |
| Line clear     | This deletes the designated tool life management data.<br>The range to be deleted can be specified. Specify the range with the first line No. and the last line No. separated by "/".<br>If the [INPUT] key is pressed without specifying a line, the data in the line where the cursor is located is erased.                                      |
| Grp No. change | This changes a group No.<br>If a new group No. is specified and the [INPUT] key pressed, the group No. changes.<br>An error occurs if an existing group No. is specified.                                                                                                                                                                          |
| Group change   | The group active area is changed if parameter "#1107 TlIfsc" is set to "1" or "2".                                                                                                                                                                                                                                                                 |
| Multi group    | Changes to the multiple group life management data display mode based on the parameter "#1107 TlIfsc" setting value.                                                                                                                                                                                                                               |
| Group regist   | This creates a new group, and the group is displayed with the tool life management data empty.                                                                                                                                                                                                                                                     |
| Group list     | This displays the group list of tool life management data.                                                                                                                                                                                                                                                                                         |
| Close          | The multiple group display mode of the tool life management data is canceled.                                                                                                                                                                                                                                                                      |

#### Operation method (Designating a group No.)

- (1) Press the menu [Group No.].
- (2) Enter the group number to be displayed in the input area, and press the [INPUT] key.

#### Note

- (1) If a group No. that does not exist is set, a message appears to confirm the creation of a new No. A new group is created if [Y] or [INPUT] is pressed.  
When creating a new group, set the method and life data at the end of the group No., separating the data with a "/". If the method and life data are omitted, a new group is created with method = 0 (cutting time), and tool life data = 0.



#### Operation method (Changing a group No.)

- (1) Press the menu [Grp No.change].
- (2) Enter the group number to be replaced in the input area, and press the [INPUT] key.

#### Note

- (1) An error occurs if the group No. duplicates a pre-existing group No.

**Operation method (Setting the tool life management data)**

- (1) Move the cursor to the data to be set using the , , [↑], [↓], [←] or [→] key.  
It is possible to move to the line after the registered line.  
Set a tool No. for this line to newly register tool life management data.
- (2) Set the tool life management data in the input area, and press the [INPUT] key.

**Note**

- (1) It is not possible to set any other data if the tool No. and compensation No. have not been set.

**Operation method (Copying/pasting the tool life management data)**

- (1) Move the cursor to the line to be copied.
- (2) Press the menu [Line copy].
- (3) Move the cursor to the line where the data is to be pasted.
- (4) Press the menu [Line paste].

**Note**

- (1) Once copied, the data is held until a new data item is copied.

**Operation method (Deleting the tool life management data by one line)**

- (1) Move the cursor to the line to be deleted.
- (2) Press the menu [Line clear] and [INPUT] keys.
- (3) Press the [Y] or [INPUT] key.  
Press a key other than [Y] or [INPUT] in order not to delete the data.

**Operation method (Designating and deleting the multiple lines)**

- (1) Press the menu [Line clear].
- (2) Set the range to be deleted by marking the first and last # Nos. with a "/".  
(Example) 1/5 [INPUT]
- (3) Press the [Y] or [INPUT] key.  
Press a key other than [Y] or [INPUT] in order not to delete the data.

**Note**

- (1) If the [INPUT] key is pressed without setting a # No., the line at the cursor is deleted.

**Operation method (Registering a group)**

- (1) Press the menu [Group regist].
- (2) Set a group No., the management method and the tool life to register separated with "/".  
The tool life management method is to be set in the "Form" column.  
Set it to "0" to manage by cutting hours, and set it to "1" to manage by number of cuttings.  
Set the tool life data as follows:  
When "0" is set to the "Form" column, set the estimated tool life (hours).  
When "1" is set to the "Form" column, set the estimated number of cuttings.  
(Example) 25/1/3000 [INPUT]

**Note**

- (1) If the method and life data are omitted, a new group is created with method = 0 (cutting time), and tool life data = 0.
- (2) An error occurs if the group No. duplicates a pre-existing group No.
- (3) The group is not registered if one of the operations below is performed after registering a new group No.
  - ♦When you quit this operation without registering even 1 item of the tool life management data.
  - ♦The screen is changed to that of other than the group unit display.
  - ♦The part system is changed.

**Operation method (Changing the active area for multiple group display)**

- (1) Press the menu [Multi group].
- (2) Press the menu [Group change].  The cursor indicating the active status moves to the next group.

**6.6.2.3 Operation Descriptions (Tool life management I)**

The tool No. which is to be used is specified by T command with this management type. The commanded tool is subject to the tool life management.

When the machining using the tool is started, "1" which indicates the status of "Tool in use" is displayed in the "Status" column. The cumulative cutting hours (or the cumulative number of cuttings) is displayed in the "Used" column.

When the cumulative cutting hours or the cumulative number of cuttings has reached the value set in the "Life" column, the display of the "A" column changes to "2" which indicates "tool life end". (\*1)

- (\*1) The status changes to "2" as soon as the cumulative cutting hours reaches the estimated tool life.  
The status changes to "2" by the T command after the cumulative number of cuttings has reached the estimated number of cuttings.

6.6.2.4 Operation Descriptions (Tool life management II)

The tools to be used are classified into several groups and their tool lives are monitored on a group basis (by the cumulative cutting hours or the cumulative number of cuttings).

When the tool which is currently being used has reached the end of its tool life, a spare tool in the same group is selected to exchange automatically at the timing of the next T command. This function enables unmanned operation over a long time.

■ T command (tool command)

Follow the format below to specify the group No. in the T command.

T□□□□99: Start to use the tool in the group □□□□.

T□□□□88: Cancel the offset of the tool in the group □□□□.  
(This is the same as "T○○00"; ○○ indicates the tool currently being used.)

When the tool No. is specified by "T○○ΔΔ", the tool life management is not performed. (○○: tool No., ΔΔ: compensation No.)

■ Tool selection

When multiple tools are registered in the same group, a spare tool is selected in the order of the registration.

The tool change is performed at the timing when the "T□□□□99" is issued after the tool currently being used has reached the end of its life.

When the tool currently being used has not reached the end of its tool life, the tool change is not performed.

When the tool change cannot be performed because all the tools in the group have reached the end of their tool lives, the tool life management function continues counting for the group.

■ Tool compensation No. selection

Multiple tool compensation Nos. can be registered to a single tool in the same group with the tool life management II.

Command the "T□□□□99" again to change the compensation No.

Command the M code for re-counting to return to the first compensation No.

[Example when multiple compensation Nos. are registered to a single tool]

| Group: 1 Form:0 Life: 300s |      |      |         |    |
|----------------------------|------|------|---------|----|
| #                          | Tool | Comp | Used(s) | ST |
| 1                          | 17   | 1    | 0       | 0  |
| 2                          | 17   | 2    | 0       | 0  |
| 3                          | 17   | 3    | 0       | 0  |
| 4                          | 21   | 4    | 0       | 0  |
| 5                          |      |      |         |    |

**Machining program**

```

T0199;
:
T0199;
:
T0199;
:
T0199;
:
(The tool of No. 17 has
reached the end of its tool life.)
:
T0199;
:

```

**Tool selection**

- ... Selects the compensation No. 1. of the tool of No. 17.
- ... Selects the compensation No. 2. of the tool of No. 17.
- ... Selects the compensation No. 3. of the tool of No. 17.
- ... Selects the compensation No. 3. of the tool of No. 17.  
Hereafter, selects the compensation No. 3. of the tool of No. 17 until this tool has reached the end of its tool life.
- ... Selects the compensation No. 4. of the tool of No. 21.

**Note**

- (1) When you register or change the tool life management data in the selected tool group, command "T□□□□99" again to re-select the group. If a new registration or a change of the data is performed in the state that any tool is being selected and then the machining operation continues, the tool life management may not function properly.
- (2) "T□□□□99" or "T□□□□88" cannot be commanded when the parameter "#1441 Tcode\_Method\_Chg" is set to "1". When "T□□□□99" or "T□□□□88" is commanded, it is regarded as "T○○ΔΔ" command. (○○: tool No., ΔΔ: compensation No.)

**Counting the cumulative cutting hours/the cumulative number of cuttings**

There are two methods for the tool life management II; the management by the cumulative cutting hours or the management by the cumulative number of cuttings.

For the management method by the cumulative number of cuttings, it depends on the MTB specifications how and when the cumulative number will be incremented. (They are determined by the setting of the parameter "#1277 ext13/bit0".)

The cumulative number is not incremented when the display of the "ST" column on the tool management screen is "3" (Abnormal tool 1) or "4" (Abnormal tool 2).

**Re-count M code**

When multiple compensation Nos. are registered for a single tool, the first compensation No. can be selected with the re-count M code.

The re-count M code can be set by the parameter "#1108 TirectM". The re-count M code is invalid when the setting value is "0". Do not set "1", "2" or "30".

**Note**

- (1) For the management method by the cumulative number of cuttings, the cumulative number will be incremented once when the machining is performed after the re-count M code is commanded.
- (2) For the management method by the cumulative cutting hours, the cumulative number is not changed even though the re-count M code is commanded, because the machining time is cumulated with this method.

**Status [ST]**

For the tool life management II, the data of the cumulative cutting hours (or the cumulative number of cuttings) is saved for each registered tool.

However, when several tools of the same No. are registered as shown the figures below, the tool life is managed by the total amount of the cumulative cutting hours (or the cumulative number of cuttings) of each tool. Thus, the display of the "ST" column for the tool, which has not reached the end of its tool life yet, may be "2" ("Normal life tool").

Management by cutting hours (Life: 300 seconds)

| Group: |      | 1    | Form:0  | Life: 300s |  |
|--------|------|------|---------|------------|--|
| #      | Tool | Comp | Used(s) | ST         |  |
| 1      | 17   | 1    | 150     | 2          |  |
| 2      | 17   | 2    | 150     | 2          |  |
| 3      | 17   | 3    | 0       | 2          |  |
| 4      | 21   | 4    | 0       | 0          |  |
| 5      |      |      |         |            |  |

Management by number of cuttings (Used: 20 times)

| Group: |      | 1    | Form:1    | Life: 20set |  |
|--------|------|------|-----------|-------------|--|
| #      | Tool | Comp | Used(set) | ST          |  |
| 1      | 17   | 1    | 10        | 2           |  |
| 2      | 17   | 2    | 10        | 2           |  |
| 3      | 17   | 3    | 0         | 2           |  |
| 4      | 21   | 4    | 0         | 0           |  |
| 5      |      |      |           |             |  |

The display of the "ST" column on the tool life management screen is updated to "2" when the NC is reset after the cumulative number of cuttings has reached the estimated number.

6.6.2.5 Registering the Tool Life Management Data Groups on the Group List Display Screen (Tool Life Management II)

Tool life management data groups can be registered and deleted. The tool life management method and the tool life data can also be set in this screen.

Press the menu [Group list] to change to this screen when the group unit is displayed.

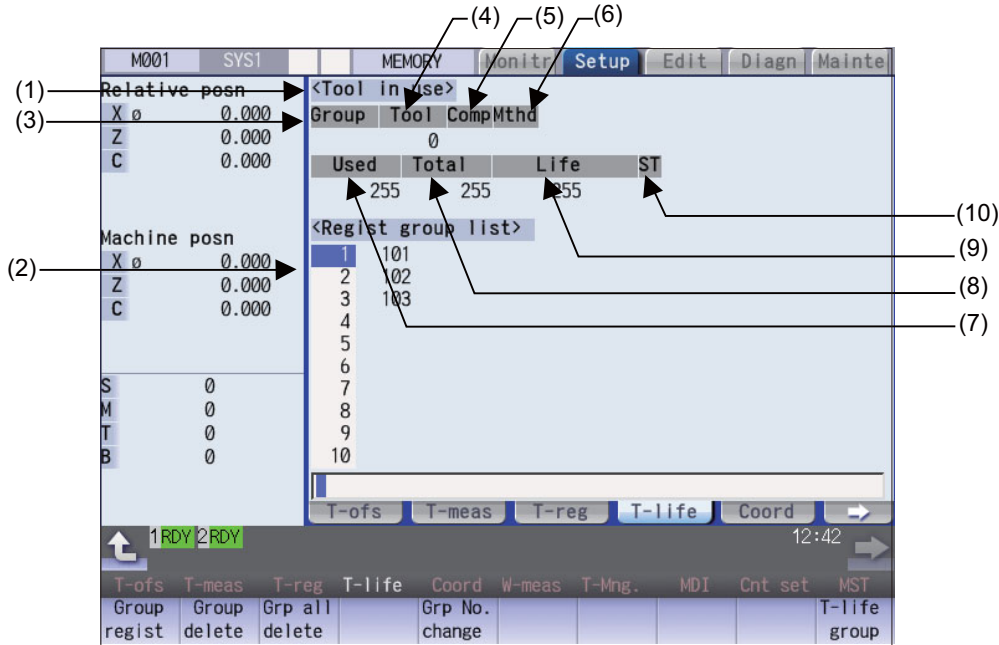

Display items

| Display items         | Details                                                                                                                                                                                                                                                                                                                                             |
|-----------------------|-----------------------------------------------------------------------------------------------------------------------------------------------------------------------------------------------------------------------------------------------------------------------------------------------------------------------------------------------------|
| (1) Tool in use       | The life management information of the tool currently being used appears here.                                                                                                                                                                                                                                                                      |
| (2) Regist group list | The group Nos. registered as the tool life management data are displayed in a list. Group Nos. can be set from 1 to 9999, and maximum 80 groups can be set. An asterisk will be added to the No. of the group in which all tools have reached their lives.<br><Note><br>♦The maximum number of the registered groups depends on the specifications. |

<Tool in use>

| Display items | Details                                                                                                                                                                                                                                                       | Display range                                                                                     |
|---------------|---------------------------------------------------------------------------------------------------------------------------------------------------------------------------------------------------------------------------------------------------------------|---------------------------------------------------------------------------------------------------|
| (3) Group     | Displays the life management group No. currently being used.                                                                                                                                                                                                  | 1 to 9999                                                                                         |
| (4) Tool No.  | Displays the tool No. currently being used.                                                                                                                                                                                                                   | 1 to 999999                                                                                       |
| (5) Comp No.  | Displays the compensation No. currently being used.                                                                                                                                                                                                           | 1 to 80                                                                                           |
| (6) Method    | Displays whether the group currently being used is controlled by the cutting time or number of cuttings.                                                                                                                                                      | 0: Cumulative cutting hours<br>1: Cumulative number of cuttings                                   |
| (7) Used      | Displays the usage data for the tool currently being used.                                                                                                                                                                                                    | Cumulative cutting hours: 0 to 99999999 (sec)<br>Cumulative number of cuttings: 0 to 999999 (set) |
| (8) Total     | Displays the total usage data for the tool currently being used. In the case of tools using multiple compensation Nos., the total usage data for all compensation Nos. displays. In the case of only one compensation No., the same value as "Used" displays. |                                                                                                   |
| (9) Life      | Displays the life value for the tool currently being used.                                                                                                                                                                                                    | 0: Unused tool<br>1: Used tool<br>2: Normal life tool<br>3: Skipped tool                          |
| (10) ST       | Displays the status of the tool currently being used.                                                                                                                                                                                                         |                                                                                                   |

Menu items and operation methods are the same as for M system. Refer to "6.6.1.4 Registering the Tool Life Management Data Groups on the Group List Display Screen (Tool life management I/II)".

### 6.6.3 Tool Life Management Set Allocation to Part Systems

The number of tool life management sets can be set per part system.

This function is divided into following methods and which one is used depends on the MTB specifications (parameters "#1439 Tlife-SysAssign", "#12055 Tol-lifenum").

Arbitrary allocation: Arbitrarily allocates the number of tool life management sets to each part system.

Fixed allocation: Automatically and evenly allocates the number of tool life management sets to each part system.

The arbitrary allocation enables the efficient allocation because when a certain part system needs only a small number of tool life management sets, the rest can be allocated to another part system.

#### Fixed allocation

Set the parameter "#1439 Tlife-SysAssign" (Part system allocation of life management tools) to "0" to evenly allocate the number of the tool life management sets to each part system.

#### Arbitrary allocation

Set the parameter "#1439 Tlife-SysAssign" (Part system allocation of life management tools) to "1" to arbitrarily allocate the number of the tool life management sets to each part system.

The number to be allocated for each part system can be set in the parameter "#12055 Tol-lifenum".

#### Precautions

- (1) For 1-part system, up to the number of tool life management sets in the system is available regardless of the parameter setting.
- (2) Even when the specification allows arbitrary allocation, fixed allocation is applied if the parameter "#12055 Tollifenum" = 0 for all part systems.
- (3) When the specification allows arbitrary allocation, if the total number of the tool life management sets which set in the parameter "#12055 Tol-lifenum" exceeds that which set in the system, the alarm "Y05 Initial parameter error" occurs.
- (4) When the tool life management data, which exceeds the number of the tool life management sets, is input to the file, the message "Can't write file for dev B" at the time when the input data to be input exceeds that of current tool life management sets. The remaining data cannot be input. The unregistered data needs to be set again.



## 6.7 Setting and Measuring a Workpiece

### 6.7.1 Workpiece Measurement (M System)



The coordinate point for each axis can be measured on the workpiece measurement screen of the Setup screen. Install the sensor on the spindle, turn the measurement switch ON, and select manual feeding or handle feeding on the workpiece position measurement screen to bring the sensor into contact with the workpiece. Then, measure the coordinate point of each axis.

To make surface, hole, and width measurements, calculate each center coordinate from the measured coordinate, and set the obtained value to the workpiece coordinate system offset.

For the rotation measurement, the measurement result is set in the workpiece coordinate system offset (rotation center) and parameters "#8623 Coord rot centr(H)", "#8624 Coord rot centr(V)", and "#8627 Coord rot angle".

■For surface measurement (As for the hole or width measurement, the guide drawing (3) differs.)

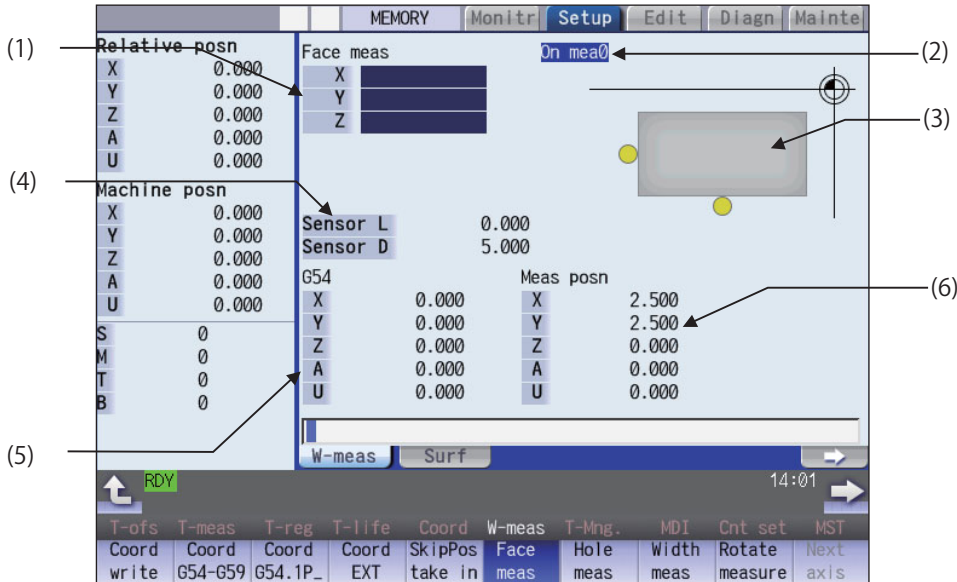

■For rotation measurement

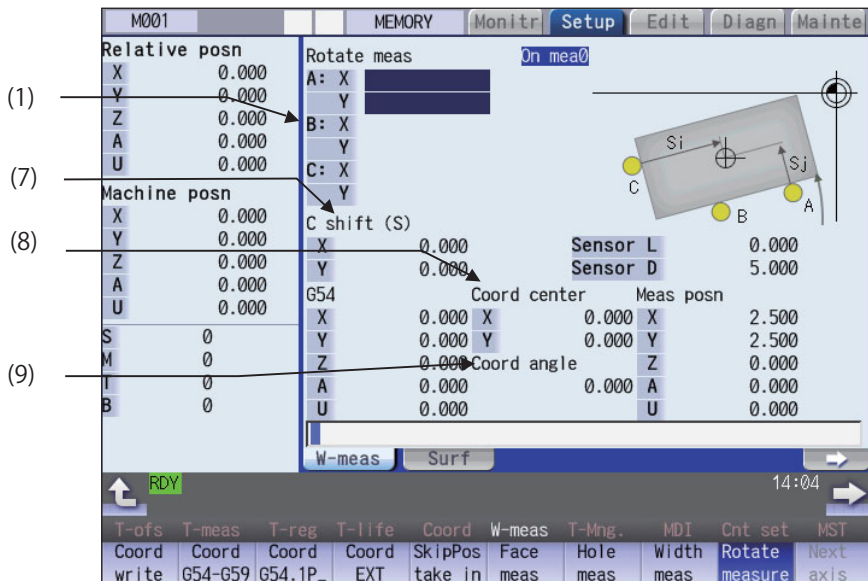

Manual numerical value command can be executed when manual numerical value command window is displayed by inputting an address key such as MST, etc.

## Display items

| Display items |                                    | Details                                                                                                                                                                                                                                                                                                                                                                                                                                                                                                                                                                                                                                                                                      |
|---------------|------------------------------------|----------------------------------------------------------------------------------------------------------------------------------------------------------------------------------------------------------------------------------------------------------------------------------------------------------------------------------------------------------------------------------------------------------------------------------------------------------------------------------------------------------------------------------------------------------------------------------------------------------------------------------------------------------------------------------------------|
| (1)           | Measurement counter                | Displays the measurement position.<br><br>As for the axis names, the 2nd axis names ("#1022 axname2") based on the basic axis name set by the parameters "#1026 base_I", "#1027 base_J" and "#1028 base_K" are displayed. Hereafter indicated as I=X, J=Y, and K=Z axes in this manual.<br><br>The measurement position becomes blank when setting the coordinate system offset amount, resetting the NC, or changing the measurement mode (when the menu [Face meas], [Hole meas], [Width meas], or [Rotate measure] is selected).<br>The display contents differ depending on the measurement pattern (surface measurement, hole measurement, width measurement, or rotation measurement). |
|               | Surface measurement counter        | Displays the calculated measurement position from the skip position for each axis (X-, Y-, Z-axes).                                                                                                                                                                                                                                                                                                                                                                                                                                                                                                                                                                                          |
|               | Hole measurement counter           | Displays 3 (A, B, C) measurement positions.                                                                                                                                                                                                                                                                                                                                                                                                                                                                                                                                                                                                                                                  |
|               | Width measurement counter          | Displays 2 (A, B) measurement positions.                                                                                                                                                                                                                                                                                                                                                                                                                                                                                                                                                                                                                                                     |
|               | Rotation measurement counter       | Displays 3 (A, B, C) measurement positions (X-, Y-axes).                                                                                                                                                                                                                                                                                                                                                                                                                                                                                                                                                                                                                                     |
| (2)           | Display of measurement in progress | "On mea" is displayed when the measurement switch on the machine operation board is ON.<br>Refer to "Manual measurement status display" in "6.3.1 Tool Measurement (M System)" for details.                                                                                                                                                                                                                                                                                                                                                                                                                                                                                                  |
| (3)           | Guide graphic                      | Displays the measurement image.<br>The contents of the guide drawing differ depending on the measurement pattern (surface measurement, hole measurement, width measurement, or rotation measurement).                                                                                                                                                                                                                                                                                                                                                                                                                                                                                        |
| (4)           | Sensor length and diameter         | Sensor length: Displays the length to the tip of the touch probe.<br>("#8701 Tool Length" setting value)<br>Sensor diameter: Displays the diameter of the ball at the tip of the touch probe.<br>("#8702 Tool Dia" setting value)                                                                                                                                                                                                                                                                                                                                                                                                                                                            |
| (5)           | Coordinate system offset           | Displays the currently selected coordinate system offset.                                                                                                                                                                                                                                                                                                                                                                                                                                                                                                                                                                                                                                    |
| (6)           | Measurement position counter       | Displays the measurement position for all axes.<br>X axis: X axis machine position + sensor radius +center compensation (Horizontal)<br>Y axis: Y axis machine position + sensor radius +center compensation (Vertical)<br>Z axis: Z axis machine position - sensor length<br>4th axis and over: Respective machine position<br>Sensor length: "#8701 Tool Length"<br>Sensor radius: "#8702 Tool Dia" /2<br>Center compensation (H): "#8703 OFFSET X"<br>Center compensation (V): "#8704 OFFSET Y"                                                                                                                                                                                           |
| (7)           | Center shift amount                | Displays the shift amount of the coordinate rotation center.                                                                                                                                                                                                                                                                                                                                                                                                                                                                                                                                                                                                                                 |
| (8)           | Coordinate rotation center         | Displays the coordinates that are the center during coordinate rotation.<br>This is the setting value of "#8623 Coord rot centr (H)" and "#8624 Coord rot centr (V)".                                                                                                                                                                                                                                                                                                                                                                                                                                                                                                                        |
| (9)           | Coordinate rotation angle          | Displays the rotation angle during coordinate rotation. This is the setting value of "#8627 Coord rot angle".                                                                                                                                                                                                                                                                                                                                                                                                                                                                                                                                                                                |

| Menus           |                                                                                                                                                                                                                                                                                                                                                                                                                                                                                                                                                                                                                                                                                                                                                                                                                                                        |
|-----------------|--------------------------------------------------------------------------------------------------------------------------------------------------------------------------------------------------------------------------------------------------------------------------------------------------------------------------------------------------------------------------------------------------------------------------------------------------------------------------------------------------------------------------------------------------------------------------------------------------------------------------------------------------------------------------------------------------------------------------------------------------------------------------------------------------------------------------------------------------------|
| Menus           | Details                                                                                                                                                                                                                                                                                                                                                                                                                                                                                                                                                                                                                                                                                                                                                                                                                                                |
| Coord write     | The results calculated from the measurement counter are set in the displayed workpiece coordinate system offset. Only the axis for which a value is displayed in the measurement counter can be set.<br><br><Note><br><ul style="list-style-type: none"> <li>•If the workpiece coordinate system to be set is G54 to G59, the local coordinate system offset value will be zero. (Only for the measured axis.)</li> <li>•When the parameter "#8924 Meas. confirm msg" is "1", this menu is highlighted and the operation message "OK?(Y/N)" appears. The measurement result is written as tool compensation amount by pressing [Y] or [INPUT] key. Even if other key is pressed, the result is not written. When this menu is pressed again while displaying the message, the highlighting is canceled and the operation message is erased.</li> </ul> |
| Coord G54-G59   | This selects the displayed workpiece coordinate system from the sub-menu (G54 - G59). Select the workpiece coordinate system to display the selected workpiece coordinate system offset in the coordinate system offset section.<br>(Perform the offset amount setting at the menu [Coord write].)                                                                                                                                                                                                                                                                                                                                                                                                                                                                                                                                                     |
| Coord G54.1 P   | Input the P number to display the selected extended workpiece coordinate system (G54.1 Pn) offset in the coordinate system offset section.<br>(Perform the offset amount setting at the menu [Coord write].)<br>This menu is not displayed if the extended workpiece coordinate system offset specification is disabled.                                                                                                                                                                                                                                                                                                                                                                                                                                                                                                                               |
| Coord EXT       | This displays the external workpiece coordinate system offset in the coordinate system offset section.<br>(Perform this setting at the menu [Coord write].)                                                                                                                                                                                                                                                                                                                                                                                                                                                                                                                                                                                                                                                                                            |
| SkipPos take in | This creates a false signal when performing simple measurement (measurement without using the touch probe) and reads the skip position. Press this menu to display the measurement position measured from the machine position of the axis moved last (axis 1 or 2) at the measurement counter. The skip position cannot be read for an axis of auxiliary axis state.                                                                                                                                                                                                                                                                                                                                                                                                                                                                                  |
| Face meas       | This enables surface measurement.<br>Surface measurement is possible when the power is turned ON.                                                                                                                                                                                                                                                                                                                                                                                                                                                                                                                                                                                                                                                                                                                                                      |
| Hole meas       | This enables hole measurement. (The cursor moves to the measurement counter point A.)                                                                                                                                                                                                                                                                                                                                                                                                                                                                                                                                                                                                                                                                                                                                                                  |
| Width meas      | This enables width measurement. (The cursor moves to the measurement counter point A.)                                                                                                                                                                                                                                                                                                                                                                                                                                                                                                                                                                                                                                                                                                                                                                 |
| Rotate measure  | This enables rotation measurement. (The cursor moves to the measurement counter point A.)                                                                                                                                                                                                                                                                                                                                                                                                                                                                                                                                                                                                                                                                                                                                                              |
| Next axis       | This changes the axes displayed at the coordinate system offset and measurement position counter every 5 axes.<br><br><Note><br><ul style="list-style-type: none"> <li>•This displays when the number of enabled axes is 6 or over.</li> </ul>                                                                                                                                                                                                                                                                                                                                                                                                                                                                                                                                                                                                         |
| Center shift    | This sets the center shift amount. (The cursor moves to the 1st axis of "C shift (S)" when this is selected.)                                                                                                                                                                                                                                                                                                                                                                                                                                                                                                                                                                                                                                                                                                                                          |
| Rotate center   | This sets the coordinate rotation center. (The cursor moves to the 1st axis of "Coord center" when this is selected.)                                                                                                                                                                                                                                                                                                                                                                                                                                                                                                                                                                                                                                                                                                                                  |
| Rotate angle    | This sets the coordinate rotation angle. (The cursor moves to "Coord rot angle" when this is selected.)                                                                                                                                                                                                                                                                                                                                                                                                                                                                                                                                                                                                                                                                                                                                                |

Details of the "Measurement counter" and "Guide drawing" display areas

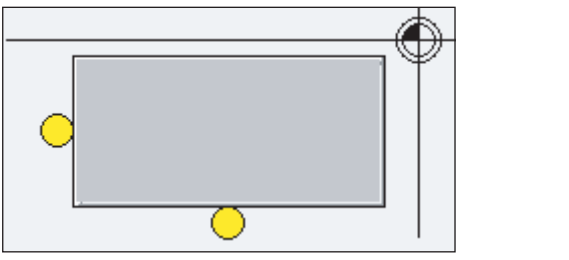
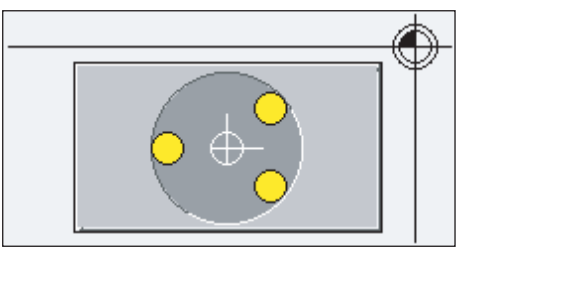
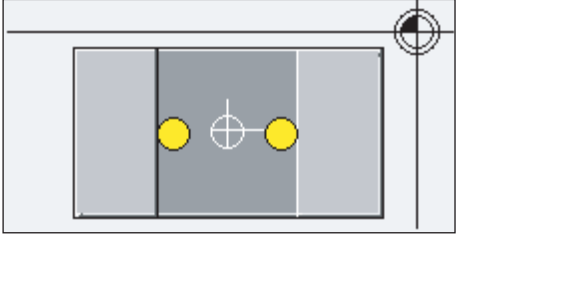
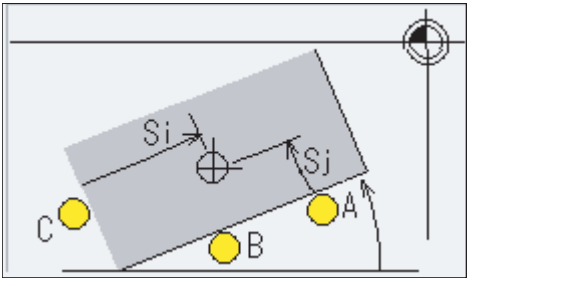
| Menus                 | Measurement counter                                                                                                                                                                                                                                                         | Guide graphic |           |    |          |      |  |                                                                                    |  |      |  |    |  |                                                                                      |
|-----------------------|-----------------------------------------------------------------------------------------------------------------------------------------------------------------------------------------------------------------------------------------------------------------------------|---------------|-----------|----|----------|------|--|------------------------------------------------------------------------------------|--|------|--|----|--|--------------------------------------------------------------------------------------|
| <p>Face meas</p>      | <p>Face meas</p> <table border="1"> <tr> <td>X</td> <td>-1566.122</td> </tr> <tr> <td>Y</td> <td>-433.368</td> </tr> <tr> <td>Z</td> <td></td> </tr> </table>                                                                                                               | X             | -1566.122 | Y  | -433.368 | Z    |  |  |  |      |  |    |  |                                                                                      |
| X                     | -1566.122                                                                                                                                                                                                                                                                   |               |           |    |          |      |  |                                                                                    |  |      |  |    |  |                                                                                      |
| Y                     | -433.368                                                                                                                                                                                                                                                                    |               |           |    |          |      |  |                                                                                    |  |      |  |    |  |                                                                                      |
| Z                     |                                                                                                                                                                                                                                                                             |               |           |    |          |      |  |                                                                                    |  |      |  |    |  |                                                                                      |
| <p>Hole meas</p>      | <p>Hole meas</p> <table border="1"> <tr> <td>A:X</td> <td>-1566.122</td> </tr> <tr> <td>Y</td> <td>-433.368</td> </tr> <tr> <td>B:X</td> <td></td> </tr> <tr> <td>Y</td> <td></td> </tr> <tr> <td>C:X</td> <td></td> </tr> <tr> <td>Y</td> <td></td> </tr> </table>         | A:X           | -1566.122 | Y  | -433.368 | B:X  |  | Y                                                                                  |  | C:X  |  | Y  |  |    |
| A:X                   | -1566.122                                                                                                                                                                                                                                                                   |               |           |    |          |      |  |                                                                                    |  |      |  |    |  |                                                                                      |
| Y                     | -433.368                                                                                                                                                                                                                                                                    |               |           |    |          |      |  |                                                                                    |  |      |  |    |  |                                                                                      |
| B:X                   |                                                                                                                                                                                                                                                                             |               |           |    |          |      |  |                                                                                    |  |      |  |    |  |                                                                                      |
| Y                     |                                                                                                                                                                                                                                                                             |               |           |    |          |      |  |                                                                                    |  |      |  |    |  |                                                                                      |
| C:X                   |                                                                                                                                                                                                                                                                             |               |           |    |          |      |  |                                                                                    |  |      |  |    |  |                                                                                      |
| Y                     |                                                                                                                                                                                                                                                                             |               |           |    |          |      |  |                                                                                    |  |      |  |    |  |                                                                                      |
| <p>Width meas</p>     | <p>Width meas</p> <table border="1"> <tr> <td>A:X</td> <td>-1566.122</td> </tr> <tr> <td>Y</td> <td>-433.368</td> </tr> <tr> <td>Z</td> <td></td> </tr> <tr> <td>B:X</td> <td></td> </tr> <tr> <td>Y</td> <td></td> </tr> <tr> <td>Z</td> <td></td> </tr> </table>          | A:X           | -1566.122 | Y  | -433.368 | Z    |  | B:X                                                                                |  | Y    |  | Z  |  |   |
| A:X                   | -1566.122                                                                                                                                                                                                                                                                   |               |           |    |          |      |  |                                                                                    |  |      |  |    |  |                                                                                      |
| Y                     | -433.368                                                                                                                                                                                                                                                                    |               |           |    |          |      |  |                                                                                    |  |      |  |    |  |                                                                                      |
| Z                     |                                                                                                                                                                                                                                                                             |               |           |    |          |      |  |                                                                                    |  |      |  |    |  |                                                                                      |
| B:X                   |                                                                                                                                                                                                                                                                             |               |           |    |          |      |  |                                                                                    |  |      |  |    |  |                                                                                      |
| Y                     |                                                                                                                                                                                                                                                                             |               |           |    |          |      |  |                                                                                    |  |      |  |    |  |                                                                                      |
| Z                     |                                                                                                                                                                                                                                                                             |               |           |    |          |      |  |                                                                                    |  |      |  |    |  |                                                                                      |
| <p>Rotate measure</p> | <p>Rotate meas</p> <table border="1"> <tr> <td>A:X1</td> <td>-1566.122</td> </tr> <tr> <td>Y1</td> <td>-433.368</td> </tr> <tr> <td>B:X1</td> <td></td> </tr> <tr> <td>Y1</td> <td></td> </tr> <tr> <td>C:X1</td> <td></td> </tr> <tr> <td>Y1</td> <td></td> </tr> </table> | A:X1          | -1566.122 | Y1 | -433.368 | B:X1 |  | Y1                                                                                 |  | C:X1 |  | Y1 |  |  |
| A:X1                  | -1566.122                                                                                                                                                                                                                                                                   |               |           |    |          |      |  |                                                                                    |  |      |  |    |  |                                                                                      |
| Y1                    | -433.368                                                                                                                                                                                                                                                                    |               |           |    |          |      |  |                                                                                    |  |      |  |    |  |                                                                                      |
| B:X1                  |                                                                                                                                                                                                                                                                             |               |           |    |          |      |  |                                                                                    |  |      |  |    |  |                                                                                      |
| Y1                    |                                                                                                                                                                                                                                                                             |               |           |    |          |      |  |                                                                                    |  |      |  |    |  |                                                                                      |
| C:X1                  |                                                                                                                                                                                                                                                                             |               |           |    |          |      |  |                                                                                    |  |      |  |    |  |                                                                                      |
| Y1                    |                                                                                                                                                                                                                                                                             |               |           |    |          |      |  |                                                                                    |  |      |  |    |  |                                                                                      |

6.7.1.1 Carrying Out Surface Measurement

When carrying out surface measurement, the position of each axis is measured and the measurement results are set in the workpiece coordinates system offset. The measurement position displays at the measurement counter.

<Measurement using touch probe>

Measurement counter X = X axis skip position + sensor radius (\*1)

Measurement counter Y = Y axis skip position + sensor radius (\*1)

Measurement counter Z = Z axis skip position - sensor length

(\*1) The sign (+ and -) changes depending on the direction of the axis moved last.

| Item          | Reference           |
|---------------|---------------------|
| Sensor radius | "#8702 Tool Dia"/2  |
| Sensor length | "#8701 Tool Length" |

<Simple measurement (measurement without using touch probe)>

Measurement counter X: X axis measurement position

Measurement counter Y: Y axis measurement position

Measurement counter Z: Z axis measurement position

**Operation method**

- (1) Press the menu [Face meas].
- (2) Perform the reference position return command, etc. to position the tool at the basic point.
- (3) Turn ON the measurement switch on the machine operation board.
- (4) Move the tool near the workpiece using manual feed and manual handle feed.

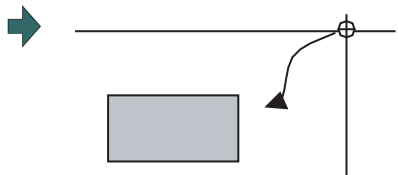



<Measurement using touch probe>

- (5) Move the tool in the X-direction until the sensor contacts the workpiece.

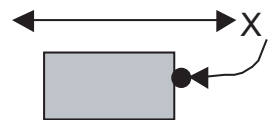
Upon contact, the axis automatically contacts the workpiece again. The measurement position measured from the skip position displays in the measurement counter X axis section.



<Simple measurement (without the touch probe)>

- (5) Move the tool in the X-direction to the arbitrary position and press the menu [SkipPos take in].  The skip position is calculated and the result displays in the measurement counter X axis section.
- (6) Select the workpiece coordinate system offset in which the measurement data will be set.  
(Example) To select G55  
Press the menus [Coord G54-G59] [G55].
- (7) Press the menu [Coord write].  The value achieved by adding or subtracting the external workpiece offset to or from the X axis measurement position based on the "#8709 Ext work sign rvs" is set in workpiece coordinate system selected at (6).  
The measurement counter displays blank.
- (8) Carry out the operations in steps (4) to (7) in the same way for the Y and Z axes.
- (9) Return the tool to the reference position, and turn the measurement switch OFF.

### 6.7.1.2 Carrying Out Hole Measurement

For hole measurement, measure the measurement position coordinate of two axes (X and Y) at three points, calculate the center of the hole, and set the result to the designated workpiece coordinate offset. The measurement position coordinate is displayed on the measurement counter.

<Measurement using touch probe>

Measurement counter X = X axis skip position

Measurement counter Y = Y axis skip position

<Simple measurement (measurement without using touch probe)>

Measurement counter X = X axis machine position + center compensation (H) + skip past amount (Horizontal axis) (\*1)

Measurement counter Y = Y axis machine position + center compensation (V) + skip past amount (Vertical axis) (\*1)

(\*1) The skip past amount is added for only the axis that moved last.

The sign ( + or - ) of the past amount depends on the movement direction of the axis.

| Item                    | Reference                  |
|-------------------------|----------------------------|
| Center compensation (H) | "#8703 OFFSET X"           |
| Center compensation (V) | "#8704 OFFSET Y"           |
| Skip past amount (H)    | "#8707 Skip past amout(H)" |
| Skip past amount (V)    | "#8708 Skip past amout(V)" |

## Operation method

- (1) Press the menu [Hole meas].



The menu is highlighted and the cursor displays at point A.  
Use the [↑] or [↓] key to move to points B and C.

- (2) Perform the reference position return command, etc. to position the tool at the basic point.

- (3) Turn ON the measurement switch on the machine operation board.

- (4) Move the tool into the hole using manual feed and manual handle feed.

<Measurement using touch probe>

- (5) Position the tool against the inner wall of the hole. Contact is performed by moving a single axis.

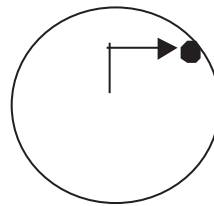

Upon contact, the axis automatically contacts the workpiece again. The skip position displays in the measurement counter point A, X and Y axis section.  
The cursor moves to point B. For point C, the cursor moves to point A.

<Without the touch probe (simple measurement)>

- (5) Move the tool to the arbitrary position and press the menu [SkipPos take in].



The skip position is calculated and the result is displayed for X and Y axes in the measurement counter A.  
The cursor moves to point B. For point C, the cursor moves to point A.

- (6) Measure points B and C in the same way.

- (7) Select the workpiece coordinate system offset in which the measurement data will be set.  
(Example) To select G55  
Press the menus [Coord G54-G59] [G55].

- (8) Press the menu [Coord write].



The hole center position is measured, and based on the "#8709 Ext work sign rvs", value achieved by adding or subtracting the external workpiece to or from the measurement result is set in workpiece coordinate system selected at (7).  
The measurement counter displays blank.

- (9) Return the tool to the reference position, and turn the measurement switch OFF.

6.7.1.3 Carrying Out Width Measurement

With width measurement, two points of the measurement position coordinate for each axis are measured, and then calculates the center between the points to set it as the workpiece coordinate offset. The measurement position displays at the measurement counter.

<Measurement using touch probe>

Measurement counter X = X axis skip position

Measurement counter Y = Y axis skip position

Measurement counter Z = Z axis skip position - sensor length

<Simple measurement (measurement without using touch probe)>

Measurement counter X = X axis machine position + center compensation (H) + skip past amount (Horizontal axis) (\*1)

Measurement counter Y = Y axis machine position + center compensation (V) + skip past amount (Vertical axis) (\*1)

Measurement counter Z = Z axis machine position - sensor length

(\*1) The skip past amount is added for only the axis that moved last.

The sign ( + or - ) of the past amount depends on the movement direction of the axis.

| Item                    | Reference                  |
|-------------------------|----------------------------|
| Sensor length           | "#8701 Tool Length"        |
| Center compensation (H) | "#8703 OFFSET X"           |
| Center compensation (V) | "#8704 OFFSET Y"           |
| Skip past amount (H)    | "#8707 Skip past amout(H)" |
| Skip past amount (V)    | "#8708 Skip past amout(V)" |

**Operation method**

- (1) Press the menu [Width meas].  The menu is highlighted and the cursor displays at point A. Use the [↑] or [↓] key to move to points A and B.
- (2) Perform the reference position return command, etc. to position the tool at the basic point.
- (3) Turn ON the measurement switch on the machine operation board.
- (4) Move the tool to the center of the groove using manual feed or manual handle feed.

<Measurement using touch probe>

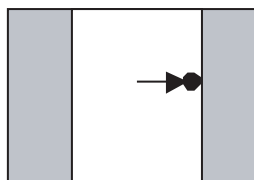

- (5) Position the tool against the inner wall of the groove.  Contact is performed by moving a single axis.



Upon contact, the axis automatically contacts the workpiece again. The skip position displays in the measurement counter point A. The cursor moves to point B. For point B, the cursor moves to point A.



<Simple measurement (without the touch probe)>

- (5) Move the tool to the arbitrary position and press the menu [SkipPos take in].  The skip position is calculated and the results displays in the movement axis section of the measurement counter A point.  
The cursor moves to point B. For point B, the cursor moves to point A.
- (6) Similarly, position the tool against the opposite side.  Upon contact, the axis automatically contacts the workpiece again. The skip position displays in the measurement counter point B.
- (7) Select the workpiece coordinate system offset in which the measurement data will be set.  
(Example) To select G55  
Press the menus [Coord G54-G59] [G55].
- (8) Press the menu [Coord write].  The width center position is measured, and based on the "#8709 Ext work sign rvs", value achieved by adding or subtracting the external workpiece offset to or from the measurement result is set in workpiece coordinate system offset G55 (coordinate system selected at (7)). The measurement counter displays blank.
- (9) Carry out the operations in steps (4) to (8) in the same way for the Y and Z axes.
- (10) Return the tool to the reference position, and turn the measurement switch OFF.

## 6.7.1.4 Carrying Out Rotation Measurement

When carrying out rotation measurement, the offset (rotation center and rotation angle) of the rotary coordinate system is measured, and the results are set to the workpiece coordinate system offset (rotation center) and the parameters "#8623 Coord rot centr(H)", "#8624 Coord rot centr(V)", and "#8627 Coord rot angle".

<Measurement using touch probe>

Measurement counter X = X axis skip position

Measurement counter Y = Y axis skip position

<Simple measurement (measurement without using touch probe)>

Measurement counter X = X axis machine position + center compensation (H) + skip past amount (Horizontal axis) (\*1)

Measurement counter Y = Y axis machine position + center compensation (V) + skip past amount (Vertical axis) (\*1)

(\*1) The skip past amount is added for only the axis that moved last.

The sign ( + or - ) of the past amount depends on the movement direction of the axis.

| Item                    | Reference                   |
|-------------------------|-----------------------------|
| Center compensation (H) | "#8703 OFFSET X"            |
| Center compensation (V) | "#8704 OFFSET Y"            |
| Skip past amount (H)    | "#8707 Skip past amount(H)" |
| Skip past amount (H)    | "#8708 Skip past amount(H)" |

**Operation method (Setting the center shift amount)**

- (1) Press the menu [Rotate measure].
- (2) Press the menu [Center shift].
- (3) Input the center shift amount (Si).  
10.000 [INPUT]
- (4) Input the center shift amount (Sj).  
-5.000 [INPUT]
- (5) Press the menu [Center shift].

**Operation method (Setting the center and angle of the coordinate rotation)**

The setting of the parameters "#8623 Coord rot centr(H)", "#8624 Coord rot centr(V)", and "#8627 Coord rot angle" can be changed.

- (1) Press the menu [Rotate measure].
- (2) Press the menu [Rotate center].
- (3) Input data in the 1st axis of "Coord center" column.  
0 [INPUT]
- (4) Input data in the 2nd axis of "Coord center" column.  
0 [INPUT]
- (5) Press the menu [Rotate center].

**Note**

- (1) Set the angle of the coordinate rotation in the same manner.

**Operation method (Carrying out the rotation measurement using touch probe to set the measurement results to the workpiece coordinate offset)**

- (1) Press the menu [Rotate measure].  The menu is highlighted and the cursor displays at point A.  
The cursor can be moved to A, B, or C, using the [↑] or [↓] key.
  - (2) Set the parameter "#8116 Coord rot para invd" to "1" (invalid).
  - (3) Turn the manual absolute switch ON.
  - (4) Set the following parameters to "0".  
#8623 Coord rot centr(H)  
#8624 Coord rot centr(V)  
#8627 Coord rot angle (\*1)
  - (5) Perform the reference position return command, etc. to position the tool at the basic point.
  - (6) Turn ON the measurement switch on the machine operation board.
  - (7) Referring to "Setting the center shift amount", set the center shift amount.  
This setting is not necessary if the coordinate rotation center is served as the workpiece coordinate zero point.
- (\*1) These parameter should be set to "0" to set the measured value to them.  
If the value other than "0" has been set, an error occurs when writing to the coordinate system.

## (8) &lt;Measurement using touch probe&gt;

Make the spindle contact the workpiece using manual feed or manual handle feed. →

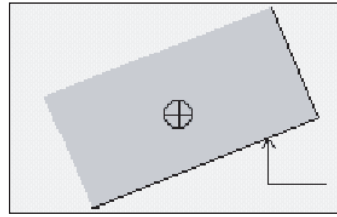

Upon contact, the skip position displays in the measurement counter point A.

The cursor moves to point B. For point C, the cursor moves to point A.

## &lt;Without the touch probe (simple measurement)&gt;

Move the spindle to the arbitrary position and press the menu [SkipPos take in]. →

The skip position is calculated and the results appear in the measurement counter point A.

The cursor moves to point B. For point C, the cursor moves to point A.

## (9) Measure points B and C in the same way.

## (10) Select the workpiece coordinate system offset in which the measurement data will be set.

(Example) To select G55  
Press the menus [Coord G54-G59] [G55].

## (11) Press the menu [Coord write]. →

The hole center position is measured.

Based on the parameter "#8709 Ext work sign rvs" setting, the value achieved by adding or subtracting the external workpiece offset to or from the measurement result is set in workpiece coordinate system selected at (10).

The parameters "#8623 Coord rot centr(H)", "#8624 Coord rot centr(V)", and "#8627 Coord rot angle" are updated.

The measurement counter displays blank.

## (12) Return the tool to the reference position, and turn the measurement switch OFF.

6.7.1.5 Performing Automatic Recontact When Contacting the Workpiece

When performing workpiece position measurement in either the JOG or handle mode, the following operations (automatic recontact) are performed after contacting the workpiece.

- (1) Moves to the measurement point using either the JOG or handle mode.

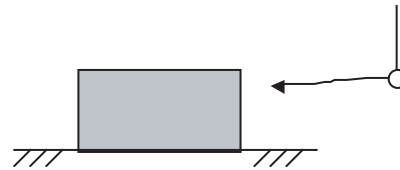

- (2) Stops at the measurement point.

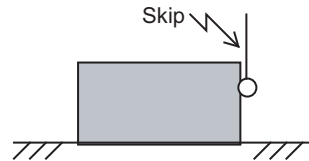

- (3) Returns by the measurement parameter return amount (#8705).

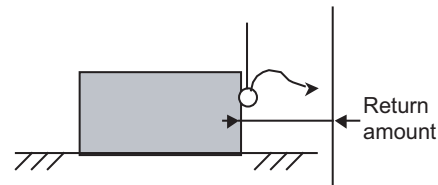

- (4) Moves to measurement point again at the measurement parameter feedrate (#8706).

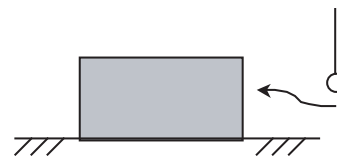

- (5) Stops at the measurement point. (The skip position is read.)

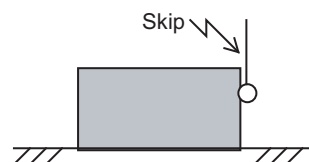

- (6) Returns by the measurement parameter return amount (#8705).

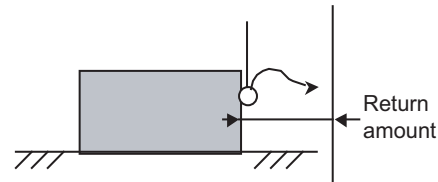

- (7) The next measurement can be performed after automatically contacting the workpiece again.

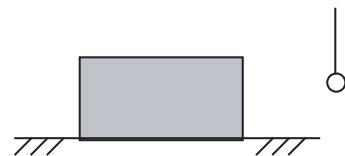

The return speed for (3) and (6) is 40 times the measurement parameter feedrate (#8706). However, if the return speed is faster than rapid traverse rate (override 100%), the rapid traverse rate will become the return speed.

### 6.7.2 Workpiece Measurement (L System)

The external workpiece coordinate offset data for the Z axis can be set by cutting the workpiece face by means of manual operations and inputting the workpiece measurement signal. By pressing the menu key, data can be set in the Z axis of an arbitrary coordinate offset.

Coordinate offset setting for the Z axis (2nd axis) of the part system 1 to 4 is possible.

Note that the workpiece coordinate offsets for multiple part systems cannot be measured at the same time.

For signals and R registers, refer to the instruction manual issued by the MTB.

**Note**

(1) Measurement is disabled for the part system with one-axis structure.

■ Example of measurement of external workpiece coordinate offset data for Z axis

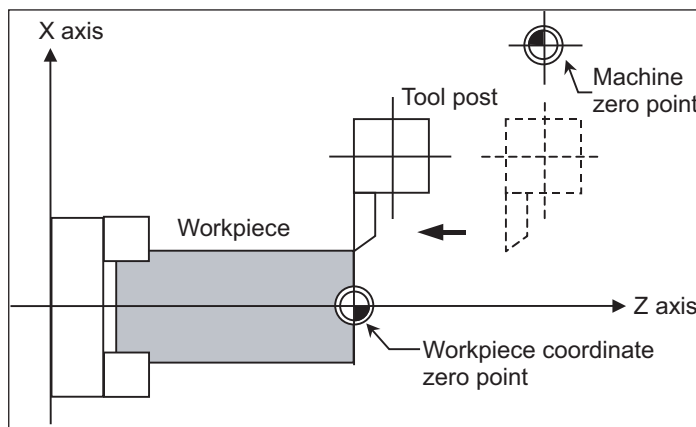

| M001          | SYS1         | MEMORY  | Monitr                                                        | Setup   | Edit    | Diagn  | Mainte |   |  |
|---------------|--------------|---------|---------------------------------------------------------------|---------|---------|--------|--------|---|--|
| Relative posn |              | EXT     | On mea0                                                       |         |         |        |        |   |  |
| (1)           | X 0          | 0.00000 | X                                                             | 0.00000 |         |        |        |   |  |
|               | Z            | 0.00000 | Z                                                             | 0.00000 |         |        |        |   |  |
|               | C            | 0.00000 | C                                                             | 0.00000 |         |        |        |   |  |
| (2)           | A            | 0.00000 | A                                                             | 0.00000 |         |        |        |   |  |
|               | Machine posn |         | Tool offset num                                               |         |         |        |        | 0 |  |
|               | X 0          | 0.00000 | Wear offset num                                               |         |         |        |        | 0 |  |
|               | Z            | 0.00000 | G54                                                           |         | X       |        |        |   |  |
| (3)           | C            | 0.00000 |                                                               | X       | 0.00000 | Z      |        |   |  |
|               | A            | 0.00000 |                                                               | Z       | 0.00000 | C      |        |   |  |
|               | S            |         |                                                               | C       | 0.00000 | A      |        |   |  |
| (4)           | M            | 0       |                                                               | A       | 0.00000 | W-meas |        |   |  |
|               | T            | 0       | 11:58                                                         |         |         |        |        |   |  |
|               | B            | 0       | T-ofs T-meas T-reg T-life Coord W-meas T-Mng. MDI Cnt set MST |         |         |        |        |   |  |
|               |              | Coord   | Coord                                                         | MeasVal |         |        |        |   |  |
|               |              | G54-G59 | G54.1P_                                                       | take in |         |        |        |   |  |

Manual numerical value command can be executed when manual numerical value command window is displayed by inputting an address key such as MST, etc.



## Display items

| Display items                            | Details                                                                                                                                                                                                                                                                                                                                                                                                                                                                                                               |
|------------------------------------------|-----------------------------------------------------------------------------------------------------------------------------------------------------------------------------------------------------------------------------------------------------------------------------------------------------------------------------------------------------------------------------------------------------------------------------------------------------------------------------------------------------------------------|
| (1) External workpiece coordinate offset | This displays the external workpiece coordinate offset.<br>When the workpiece measurement signal is input, the measurement result is set to 2nd axis of the external workpiece coordinate.<br><Note><br>•The 5th axis and following are not displayed.                                                                                                                                                                                                                                                                |
| (2) Tool L offset num                    | This displays the compensation No. of tool length data used by automatic calculation.<br><Note><br>•If an illegal value is set, the value is blank. ("0" is displayed.)                                                                                                                                                                                                                                                                                                                                               |
| (3) Wear offset num                      | This displays the compensation No. of tool nose wear data used by automatic calculation.<br><Note><br>•If an illegal value is set or tool nose wear data is not used for measurement ("#1226 aux10/bit0" is 1), the value is blank. ("0" is displayed.)                                                                                                                                                                                                                                                               |
| (4) Coordinate system offset             | This displays the coordinate system offset in which the measurement result is written when the menu [MeasVal take in] is pressed. G54 is displayed in default.<br>When the menu [MeasVal take in] is pressed, the measurement result is set to 2nd axis of the external workpiece coordinate.<br><Note><br>•The 5th axis and following are not displayed.<br>•The display of coordinate system offset area is switched by page up/down keys.<br>For details, refer to "6.8.4 Changing the Coordinate System Display". |
| (5) On mea                               | When the measurement switch is ON and the operation mode is manual mode (handle, jog, rapid traverse, or step), "On mea" is displayed, and the workpiece can be measured by the workpiece measurement signal.                                                                                                                                                                                                                                                                                                         |
| (6) Guide graphic                        | This displays the measurement area.                                                                                                                                                                                                                                                                                                                                                                                                                                                                                   |

## Menus

| Menus              | Details                                                                                                                                                                                                                                                                                                                                                                                                                                          |
|--------------------|--------------------------------------------------------------------------------------------------------------------------------------------------------------------------------------------------------------------------------------------------------------------------------------------------------------------------------------------------------------------------------------------------------------------------------------------------|
| Coord<br>G54-G59   | This selects the coordinate system offset which sets the measurement value when [MeasVal take in] is executed from sub-menu (G54 - G59). The workpiece coordinate system offset data is displayed after selected. However, the cursor is not displayed and the data cannot be set.                                                                                                                                                               |
| Coord<br>G54.1 P   | This selects the coordinate system offset which sets the measurement value when [MeasVal take in] is executed. Input the P No. to display the selected external workpiece coordinate system (G54.1 Pn) offset in the coordinate system offset area. However, the cursor is not displayed and the data cannot be set.<br>If the extended workpiece coordinate system offset specification is invalid, this menu is grayed out and non-selectable. |
| MeasVal<br>take in | This measures G54 - G59 and G54.1Pn. When this menu is pressed, the workpiece coordinate offset data is calculated from the machine coordinate, the used tool length, the tool nose wear compensation amount and the external workpiece coordinate offset, and the data is stored in Z axis of the selected coordinate system offset.                                                                                                            |

**Operation method (When the workpiece measurement signal is used)**

- |                                                                                                                                                                                                                                                           |                                                                                     |                                                                                                                                                                                                                                                                                        |
|-----------------------------------------------------------------------------------------------------------------------------------------------------------------------------------------------------------------------------------------------------------|-------------------------------------------------------------------------------------|----------------------------------------------------------------------------------------------------------------------------------------------------------------------------------------------------------------------------------------------------------------------------------------|
| (1) Execute the reference position return.                                                                                                                                                                                                                |    | The coordinate system is established.<br><Note><br>•If the workpiece is measured without establishing the reference position return, the operation message "Meas axis not returned to ref. position" appears.                                                                          |
| (2) Set the mode selection switch to the manual mode (handle, jog, rapid traverse, or step).                                                                                                                                                              |                                                                                     |                                                                                                                                                                                                                                                                                        |
| (3) Set the tool length measurement signal to "1".                                                                                                                                                                                                        |                                                                                     |                                                                                                                                                                                                                                                                                        |
| (4) Select whether to measure the workpiece coordinate on the main spindle side or sub-spindle side by using tool presetter sub-side valid signal.<br><Note><br>•Hold the state of this signal until the measurement with the selected tool is completed. |                                                                                     |                                                                                                                                                                                                                                                                                        |
| (5) Issue the T command with MDI operation, etc.                                                                                                                                                                                                          |    | The tool is selected.<br><Note><br>•Set the selected tool compensation No. in R register. The set R register differs according to parameter setting and the state of the tool presetter sub-side valid signal.<br>•Set the "tool length/wear data" for the tool being used beforehand. |
| (6) Cut the workpiece face slightly to even it.<br><Note><br>•Do not move the tool in the Z axis direction after cutting the workpiece face.<br>•If the workpiece does not need to be cut, carry out positioning to the measurement position.             |                                                                                     |                                                                                                                                                                                                                                                                                        |
| (7) Input the workpiece measurement signal.                                                                                                                                                                                                               |  | The Z axis external workpiece coordinate offset data is automatically calculated from the tool compensation data of the used tool and the machine value at the point this signal is input. The results are set as the data.                                                            |
| (8) Set the tool length measurement signal to OFF.                                                                                                                                                                                                        |                                                                                     |                                                                                                                                                                                                                                                                                        |



**Operation method (When the menu [MeasVal take in] is used)**

- |                                                                                                                                                                                                                                                              |   |                                                                                                                                                                                                                                                                                                                                                                |
|--------------------------------------------------------------------------------------------------------------------------------------------------------------------------------------------------------------------------------------------------------------|---|----------------------------------------------------------------------------------------------------------------------------------------------------------------------------------------------------------------------------------------------------------------------------------------------------------------------------------------------------------------|
| (1) Execute the reference position return.                                                                                                                                                                                                                   | ➔ | <p>The coordinate system is established.</p> <p>&lt;Note&gt;</p> <ul style="list-style-type: none"> <li>◆If the workpiece is measured without establishing the reference position return, the operation message "Meas axis not returned to ref. position" appears.</li> </ul>                                                                                  |
| (2) Set the mode selection switch to the manual mode (handle, jog, rapid traverse, or step).                                                                                                                                                                 |   |                                                                                                                                                                                                                                                                                                                                                                |
| (3) Select an arbitrary coordinate system offset.                                                                                                                                                                                                            | ➔ | <p>The designated coordinate system offset is selected.</p> <p>&lt;Note&gt;</p> <ul style="list-style-type: none"> <li>◆When switching to an arbitrary coordinate system offset display, press one of these menus; [Coord G54 - G59] [Coord G54.1P] or page key.</li> </ul>                                                                                    |
| (4) Select whether to measure the workpiece coordinate on the main spindle side or sub-spindle side by using tool presetter sub-side valid signal.                                                                                                           |   |                                                                                                                                                                                                                                                                                                                                                                |
| <p>&lt;Note&gt;</p> <ul style="list-style-type: none"> <li>◆Hold the state of this signal until the measurement with the selected tool is completed.</li> </ul>                                                                                              |   |                                                                                                                                                                                                                                                                                                                                                                |
| (5) Issue the T command with MDI operation, etc.                                                                                                                                                                                                             | ➔ | <p>The tool is selected.</p> <p>&lt;Note&gt;</p> <ul style="list-style-type: none"> <li>◆Set the selected tool compensation No. in R register. The set R register differs according to parameter setting and the state of the tool presetter sub-side valid signal.</li> <li>◆Set the "tool length/wear data" for the tool being used beforehand.</li> </ul>   |
| (6) Cut the workpiece face slightly to even it.                                                                                                                                                                                                              |   |                                                                                                                                                                                                                                                                                                                                                                |
| <p>&lt;Note&gt;</p> <ul style="list-style-type: none"> <li>◆Do not move the tool in the Z axis direction after cutting the workpiece face.</li> <li>◆If the workpiece does not need to be cut, carry out positioning to the measurement position.</li> </ul> |   |                                                                                                                                                                                                                                                                                                                                                                |
| (7) Press the menu [MeasVal take in].                                                                                                                                                                                                                        | ➔ | <p>The workpiece measurement is executed.</p> <p>The operation message "OK?(Y/N)" appears, so press the [Y] or [INPUT].</p> <p>The Z axis external workpiece coordinate offset data is automatically calculated from the tool compensation data of the used tool and the machine value at the point this signal is input. The results are set as the data.</p> |

**Details of automatic calculation formula (When the workpiece measurement signal is used)**

The external workpiece coordinate offset data is automatically calculated with the following expression.

$$\text{External workpiece coordinate offset} = \text{Machine coordinate value} - \text{Tool compensation data}$$

The tool compensation data used for the measurement is selected with the parameter "#1226 aux10/bit0".

| #1226 aux10/bit0 | Tool compensation data            |
|------------------|-----------------------------------|
| 0                | Tool length data + nose wear data |
| 1                | Tool length data                  |

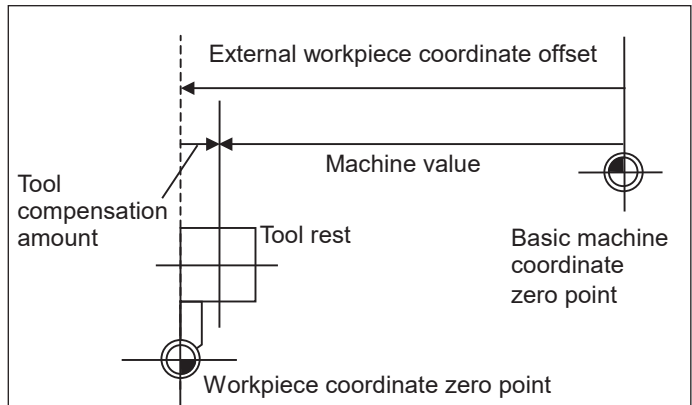

**Details of automatic calculation formula (When the menu [MeasVal take in] is used)**

The workpiece coordinate offset data is automatically calculated with the following expression.

The calculation formula changes depending on the parameter "#8709 Ext work sign rvs".

When "#8709" is "0":

$$\text{Workpiece coordinate offset} = \text{Machine coordinate value} - \text{External workpiece coordinate offset} - \text{Tool compensation data}$$

When "#8709" is "1":

$$\text{Workpiece coordinate offset} = \text{Machine coordinate value} + \text{External workpiece coordinate offset} - \text{Tool compensation data}$$

The tool compensation data used for the measurement is selected with the parameter "#1226 aux10/bit0".

| #1226 aux10/bit0 | Tool compensation data            |
|------------------|-----------------------------------|
| 0                | Tool length data + nose wear data |
| 1                | Tool length data                  |

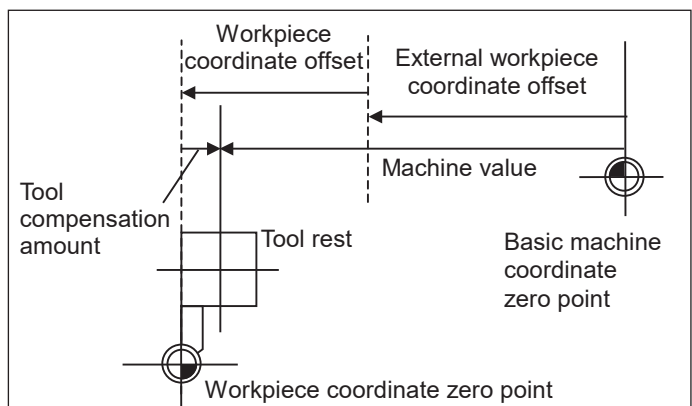

**The selected tool compensation No.**

For the compensation No. of the tool length and tool nose wear data used by automatic calculation, the No. set in R register in the following table is used.

| #1098 TIno. | #1130 set_t | #1218 aux02 / bit4 | Tool L offset num |              | Wear offset num |              |
|-------------|-------------|--------------------|-------------------|--------------|-----------------|--------------|
|             |             |                    | Main side         | Sub-side     | Main side       | Sub-side     |
| 0           | 0/1         | 0/1                | R2600, R2601      | R2604, R2605 | R2600, R2601    | R2604, R2605 |
| 1           | 0           | 0                  | R536, R537        |              |                 |              |
|             |             | 1                  | R2602, R2603      | R2606, R2607 |                 |              |
|             | 1           | 0/1                |                   |              |                 |              |

**Note**

- (1) When the compensation No. is 0, the compensation amount will be calculated as "0".
- (2) If the compensation No. exceeds the number of specified offset sets, the operation message "Offset No. not found" appears.  
However, when the workpiece measurement screen is not displayed, the message will not appear.
- (3) If the input data exceeds the setting range, the operation message "Data range error" appears.  
However, when the workpiece measurement screen is not displayed, the message will not appear.
- (4) If the data protection is valid, the operation message "Data protect" appears.  
However, when the workpiece measurement screen is not displayed, the message will not appear.
- (5) Whether to use the main side or sub-side is selected with the tool presetter sub-side valid signal.  
(OFF: Main side, ON: Sub-side)  
However, when the workpiece measurement screen is not displayed, the message will not appear.
- (6) Set the compensation No. in R register by the BCD code.

## 6.8 Setting Workpiece Coordinate System Offset

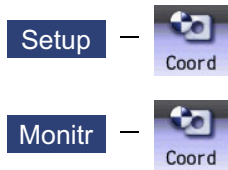

The coordinate system offset and workpiece installation error compensation controlled by the NC can be set and displayed on the monitor (Monitr) screen or the Setup screen.

Depending on the specifications, the number of coordinate system offset sets can be increased by 48, 96, or 300 sets.

### Note

- (1) The G92/G52 coordinate system offset cannot be set.
- (2) Workpiece installation error compensation is displayed only when the workpiece installation error compensation specification is valid.

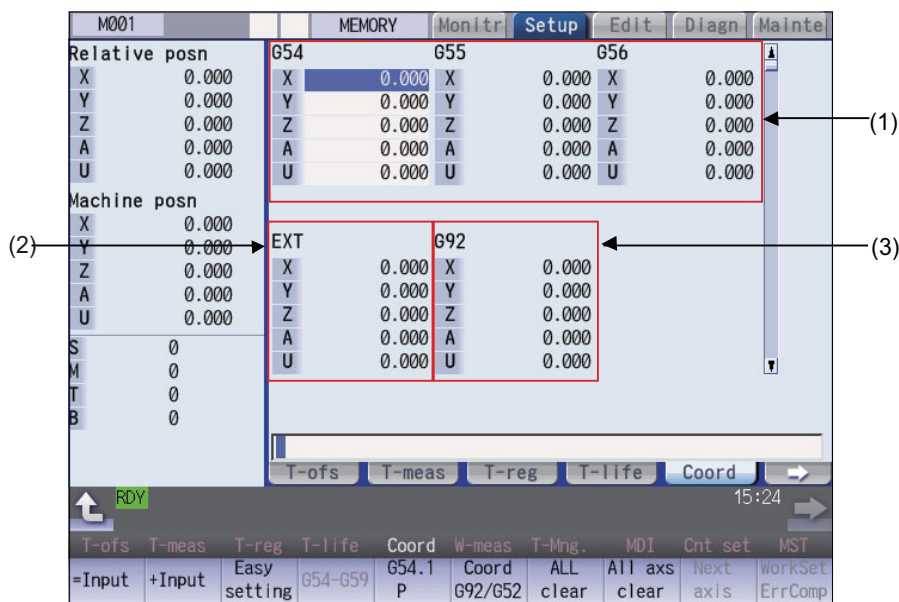

Manual numerical value command can be executed when manual numerical value command window is displayed by inputting an address key such as MST, etc.

| Display items                     |                                                                                                                                                                                                                                                                                                                                                                                                                                                                                |                                                                                                                                                                                                                                                                                                                                                                                                                               |
|-----------------------------------|--------------------------------------------------------------------------------------------------------------------------------------------------------------------------------------------------------------------------------------------------------------------------------------------------------------------------------------------------------------------------------------------------------------------------------------------------------------------------------|-------------------------------------------------------------------------------------------------------------------------------------------------------------------------------------------------------------------------------------------------------------------------------------------------------------------------------------------------------------------------------------------------------------------------------|
| Display items                     | Details                                                                                                                                                                                                                                                                                                                                                                                                                                                                        |                                                                                                                                                                                                                                                                                                                                                                                                                               |
| (1) Coordinate system offset area | <p>This sets and displays the offset amount for the workpiece coordinate system (G54 - G59), or the extended workpiece coordinate system (G54.1Pn). Use the menu operation or page up/down keys to specify which workpiece coordinate system offset to display or set.</p> <p>The workpiece coordinate system offset data can be set in absolute, incremental, or subtracted position.</p> <p>Setting range: - 99999.999 to 99999.999 (mm) (When "#1003 iunit"= B, micron)</p> | <p>The diagram illustrates the relationship between different coordinate systems. At the top is the 'Basic machine coordinate system' with origin 'M'. Below it is the 'External workpiece coordinate system'. Further down are two 'G54 workpiece coordinate system' (W1) and 'G55 workpiece coordinate system' (W2). A 'Reference position' (R) is also shown. Dashed lines indicate the offsets between these systems.</p> |
| (2) EXT offset area               | This displays or sets the offset data for the external workpiece system.                                                                                                                                                                                                                                                                                                                                                                                                       |                                                                                                                                                                                                                                                                                                                                                                                                                               |
| (3) G92/G52 offset area           | This displays the offset amount for G92 or the local coordinate system. The offset amount of the corresponding local coordinate system (G52) is displayed only when the cursor is at G54 to G59.                                                                                                                                                                                                                                                                               |                                                                                                                                                                                                                                                                                                                                                                                                                               |

**CAUTION**

If the tool compensation amount or workpiece coordinate system offset amount is changed during automatic operation (including during single block stop), the changes will be valid from the command in the next block or after several subsequent blocks.

**Menus**

| Menus         | Details                                                                                                                                                                                                                                                                                                                                                                      |
|---------------|------------------------------------------------------------------------------------------------------------------------------------------------------------------------------------------------------------------------------------------------------------------------------------------------------------------------------------------------------------------------------|
| =Input        | <p>This executes an absolute input.</p> <p>When "#8929 Disable=INPUT:comp" is set to "1", this menu cannot be selected.</p> <p>This menu is displayed when you select the menu [Input =/+ ] or [Input =/- ] under the menu [Input menu].</p>                                                                                                                                 |
| +Input        | <p>This executes an incremental input.</p> <p>This menu is displayed when you select the menu [Input =/+ ] or [Input -/+ ] under the menu [Input menu].</p>                                                                                                                                                                                                                  |
| -Input        | <p>This executes a subtraction input.</p> <p>This menu is displayed when you select the menu [Input -/+ ] or [Input =/- ] under the menu [Input menu].</p>                                                                                                                                                                                                                   |
| Easy setting  | <p>This sets the workpiece coordinate system offset so that the current machine coordinate becomes the workpiece coordinate zero point.</p> <p>Only the axis at the cursor position is set.</p> <p>When "#8935 W COORD CONFIRM" is set to "1", a operation message is displayed, and the menu is highlighted.</p>                                                            |
| G54-G59       | This displays the G54 - G59 workpiece coordinate system offset amount. The cursor moves to the G54 offset. This menu can be used when the G54 - G59 offsets are not displayed.                                                                                                                                                                                               |
| G54.1 P       | <p>Enter the P number displayed at the screen to display the extended workpiece coordinate (G54.1 Pn) offset in the coordinate system offset area. This menu is not displayed if the extended workpiece coordinate system offset specification is disabled.</p> <p>If the local coordinate system offset (G52) displays in the G92/G52 area, the display changes to G92.</p> |
| Coord G92/G52 | This displays the G92 or G52 coordinate system offset amount. The G92 offset data is always displayed when the cursor is not at the G54 to G59 offset data.                                                                                                                                                                                                                  |
| All clear     | <p>Coordinate system offset</p> <p>All coordinate system offset amounts for all axes are erased with the exception of G92 and EXT.</p> <p>Workpiece installation error compensation</p> <p>This erases all of workpiece installation error compensation data except the common workpiece installation error compensation amount.</p>                                         |

| Menus           | Details                                                                                                                                                                                                                                                                                                          |
|-----------------|------------------------------------------------------------------------------------------------------------------------------------------------------------------------------------------------------------------------------------------------------------------------------------------------------------------|
| All axis clear  | Coordinate system offset<br>This erases the local offset data for all axes corresponding to the offset data of the coordinate system where the cursor is located.<br>Workpiece installation error compensation<br>This erases the coordinate system compensation data where the cursor is located.               |
| Next axis       | This changes the axes displayed at the coordinate system offset and measurement position counter every five axes.<br><Note><br>•This displays when there are 6 or more axes.                                                                                                                                     |
| WorkSet ErrComp | This displays workpiece installation error compensation screen.<br>While the workpiece installation error is displayed, the menu will be kept highlighted.<br><Note><br>•It cannot be selected when the workpiece installation error compensation specification is not valid.                                    |
| RotAxis WorkCmp | This displays the screen of workpiece position offset for rotary axis.<br>While the workpiece position offset for rotary axis is being executed, the menu will be kept highlighted.<br><Note><br>•If the specification of workpiece position offset for rotary axis is not enabled, this menu is non-selectable. |
| Input menu      | Press this menu and select input menus to be displayed between [=Input], [+Input] and [-Input].                                                                                                                                                                                                                  |

### Note







- (1) The menus [Easy setting], [G54-G59], [G54.1P], [Coord G92/52] and [Next axis] are non-selectable on the screen of the workpiece position offset for rotary axis.
- (2) The menus [Easy setting], [G54-G59], [G54.1P] and [Coord G92/52] are non-selectable on the screen of the workpiece position offset for rotary axis. The menu [Next axis] is also non-selectable when the number of axes is 6 or less.

Sub-menus of [Input menu].

| Menus     | Details                                        |
|-----------|------------------------------------------------|
| Input =/+ | This displays the menus [=input] and [+Input]. |
| Input -/+ | This displays the menus [-input] and [+Input]. |
| Input =/- | This displays the menus [=input] and [-Input]. |

## 6.8.1 Setting the Coordinate System Offset Amount

**Operation method (Setting the workpiece coordinate system G54 - G59 offset amount)**

- (1) Press the menu [G54-G59].  The G54 - G59 workpiece coordinate system offset displays.
  
- (2) Use the ( ) keys to move the cursor to the workpiece coordinate system offset to be set.  
 Use the  and  page keys to change the coordinate system display.  
 Refer to "Changing the coordinate system offset using the page up/down keys (previous page: , next page: )" in "6.8.4 Changing the Coordinate System Display" for details.)
  
- (3) Use the [ $\uparrow$ ] or [ $\downarrow$ ] key to move the cursor to the axis for which data is to be set.
  
- (4) Set the offset amount.  
 122 [INPUT]  
 The value can also be designated by pressing the menu [=Input] instead of the [INPUT] key.
  
- (5) Set other data using the same method.

**Note**



- (1) It is possible to perform incremental input by pressing the menu [+Input] key instead of the [INPUT] key or the menu [=Input].  
 (Example) If the original data is 122.000:  
 $1.234 [+Input] \rightarrow 122.000 + 1.234 = 123.234$

**Setting the external coordinate system offset amount**



Set the external coordinate system offset amount to keep the current workpiece coordinate system offset amounts from G54 to G59, and also apply an offset to the entire system.  
 Furthermore, it is also possible to use the data transfer function to write data directly to the external coordinate system offset (EXT). (Refer to "Chapter 12 Performing a Backup Operation" for details of the data transfer function.)

## 6.8.2 Erasing the Coordinate System Offset Amount

**Operation method (Erasing the coordinate system (excluding G92) offset amount where the cursor is displayed for all axes.)**

- |                                    |                                                                                   |                                                                                                                                                                            |
|------------------------------------|-----------------------------------------------------------------------------------|----------------------------------------------------------------------------------------------------------------------------------------------------------------------------|
| (1) Press the menu [All ax clear]. |  | A message displays confirming whether it is okay to erase the data.                                                                                                        |
| (2) Press the [Y] key.             |  | All of the coordinate system indicated by the cursor is cleared to zero.<br>In addition, all axes data of the local offset (G52) for the coordinate system will be erased. |

**Operation method (Erasing all axis offset data of all coordinate systems (excluding G92 and EXT))**

- |                                 |                                                                                   |                                                                                                                                                     |
|---------------------------------|-----------------------------------------------------------------------------------|-----------------------------------------------------------------------------------------------------------------------------------------------------|
| (1) Press the menu [All clear]. |  | A message displays confirming whether it is okay to erase the data.                                                                                 |
| (2) Press the [Y] key.          |  | All coordinate system data is erased.<br>In addition, all axes data of the local offset (G52) for the G54 to G59 coordinate systems will be erased. |

**Note**

- (1) G92 data cannot be erased.

## 6.8.3 Setting the Workpiece Coordinate Origin

Press the menu [Easy setting] to set the coordinate system offset so that the current machine position (for all axes) becomes the workpiece coordinate origin. It is only possible to set those axes where the cursor is located.

If the menu [Easy setting] is pressed when there is the cursor in coordinate system offset (G54 to G59), the local offset (G52) data of the axis will be also erased.



### 6.8.4 Changing the Coordinate System Display

**Using the tab keys (←/→) to change cursor position**

The counter on which the cursor is displayed can be switched using the tab keys as shown below.

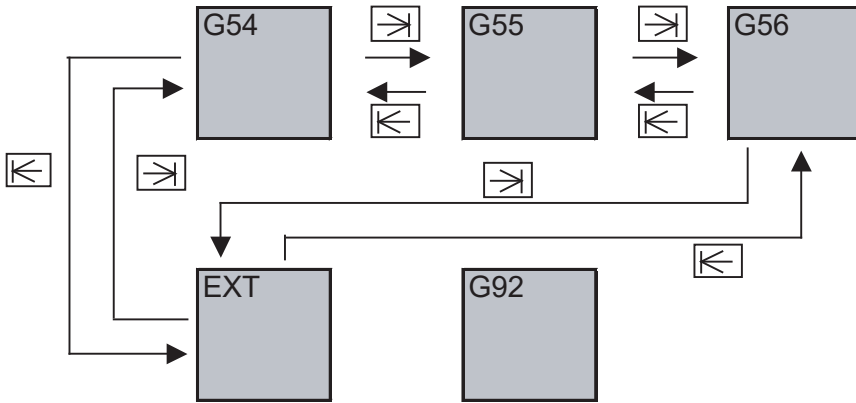

**Using the page changeover keys (previous page: ▲, next page: ▼) to change counter display**

The coordinate system offset display can be switched using the page changeover keys as shown below.

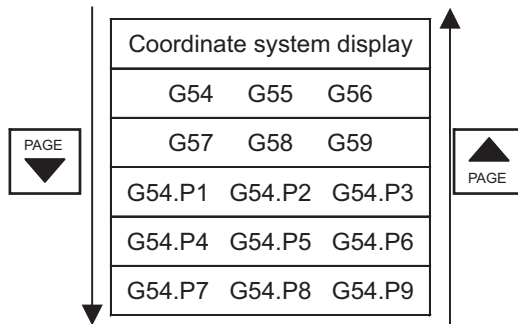

The additional specification is required for the G54.P1 - P300 workpiece coordinate system offset display.

### 6.8.5 Changing the Input Menus to Display

The offset data can also be input by menu operation, with absolute, incremental or subtracted position. You can change the menus to be displayed on the screen by pressing the menu [Input menu].

**Operation method**

(Example) To display the menus [-Input] and [+Input]

- (1) Press the menu [Input menu]. ➡ The menu which is currently being selected will be highlighted.
- (2) Press the menu [-/+ Input]. ➡ The menus [-Input] and [+Input] are displayed.

**Note**

- (1) The selected menus are maintained even after the power is turned ON again.

6.8.6 Compensating the Workpiece Installation Error Data

This function can set and display the workpiece installation error compensation controlled by the NC. This function is an additional specification. And this is the function for each part system.

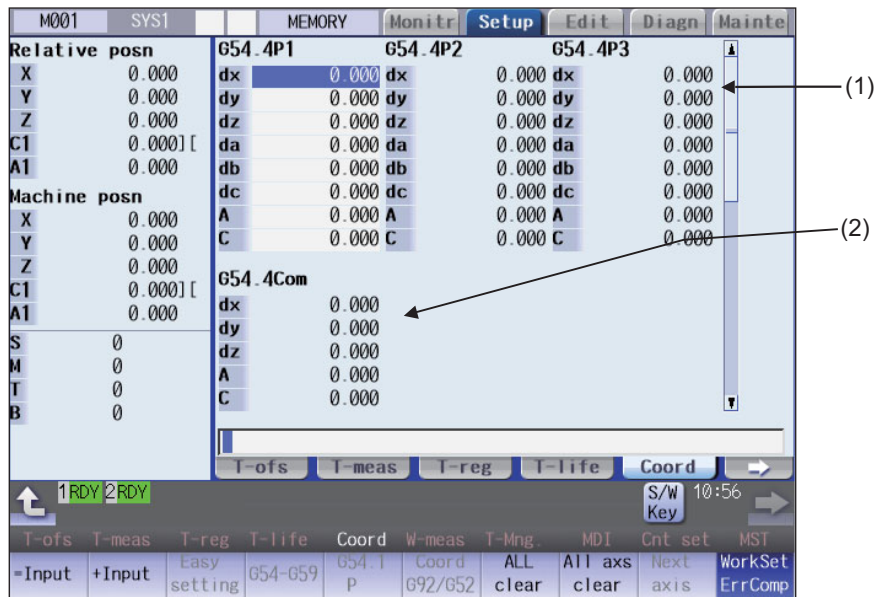

Display items

| Display items                                        | Details                                                                                                                                                                                                                                                                                                                                                                                                                                                                                                                                                                                                                                                                                                                                                                                                                                                                                                                                                                                                                                                                                                                                                                                                                                                                                                                                                                                                                                                                                                                                                                                                                                                                                                                                                                                                                                                                                                                                                                                                                                                                                                                                                                                                                                                                                                                                                                                                                                                                                    |
|------------------------------------------------------|--------------------------------------------------------------------------------------------------------------------------------------------------------------------------------------------------------------------------------------------------------------------------------------------------------------------------------------------------------------------------------------------------------------------------------------------------------------------------------------------------------------------------------------------------------------------------------------------------------------------------------------------------------------------------------------------------------------------------------------------------------------------------------------------------------------------------------------------------------------------------------------------------------------------------------------------------------------------------------------------------------------------------------------------------------------------------------------------------------------------------------------------------------------------------------------------------------------------------------------------------------------------------------------------------------------------------------------------------------------------------------------------------------------------------------------------------------------------------------------------------------------------------------------------------------------------------------------------------------------------------------------------------------------------------------------------------------------------------------------------------------------------------------------------------------------------------------------------------------------------------------------------------------------------------------------------------------------------------------------------------------------------------------------------------------------------------------------------------------------------------------------------------------------------------------------------------------------------------------------------------------------------------------------------------------------------------------------------------------------------------------------------------------------------------------------------------------------------------------------------|
| (1) Workpiece installation error compensation amount | <p>This displays and sets an offset amount of the workpiece installation coordinate system (G54.4Pn).<br/>                     The workpiece coordinate system offset data can be set in absolute, incremental, or subtracted position.<br/>                     The number of display or setting digits is determined by the value set in "#1003 iunit" for \$1.<br/>                     (Example) - 99999.999 to 99999.999 (mm) ("#1003 iunit"= B, micron)<br/>                     Details of displayed contents are as follows:</p> <div style="margin-left: 40px;"> <p>(a) Workpiece installation coordinate system → G54.4P1</p> <p>(b) Error in the XYZ directions</p> <ul style="list-style-type: none"> <li>dx 1.000 ← Δx(Error in the X directions)</li> <li>dy 10.000 ← Δy(Error in the Y directions)</li> <li>dz 100.000 ← Δz(Error in the Z directions)</li> </ul> <p>(c) Error in the rotation direction of each axis</p> <ul style="list-style-type: none"> <li>da 1000.000 ← Δa(Error in the rotation direction of X axis)</li> <li>db 10000.000 ← Δb(Error in the rotation direction of Y axis)</li> <li>dc -10.000 ← Δc(Error in the rotation direction of Z axis)</li> </ul> <p>(d) Table rotation axis position when measuring the errors</p> <ul style="list-style-type: none"> <li>A -100.000 ← Rotary axis 1</li> <li>C -1000.000 ← Rotary axis 2</li> </ul> </div> <p>(a) Workpiece installation coordinate system<br/>                     Workpiece installation error displays seven sets of error amount (G54.4P1 to G54.4P7) corresponding to the compensation No. commanded with address P.</p> <p>(b) Errors in the XYZ directions (Δx, Δy, Δz)<br/>                     Set the zero point of the workpiece installation coordinate system seen from the original workpiece coordinate system.<br/>                     The error name of each axis direction starts with d (fixed) then a small letter of an orthogonal coordinate axis (the axis name set in #7900 RCDAX_I, #7901 RCDAX_J, #7902 RCDAX_K) of \$1.<br/>                     ♦#7900 RCDAX_I ... If X, it is "dx".<br/>                     ♦#7901 RCDAX_J ... If Y, it is "dy".<br/>                     ♦#7902 RCDAX_K ... If Z, it is "dz".</p> <p>&lt;Note&gt;<br/>                     ♦When the orthogonal coordinate axis (the axis name set in #7900 RCDAX_I, #7901 RCDAX_J, #7902 RCDAX_K) is two letters, only the first letter is added in lowercase letters and displayed.</p> |

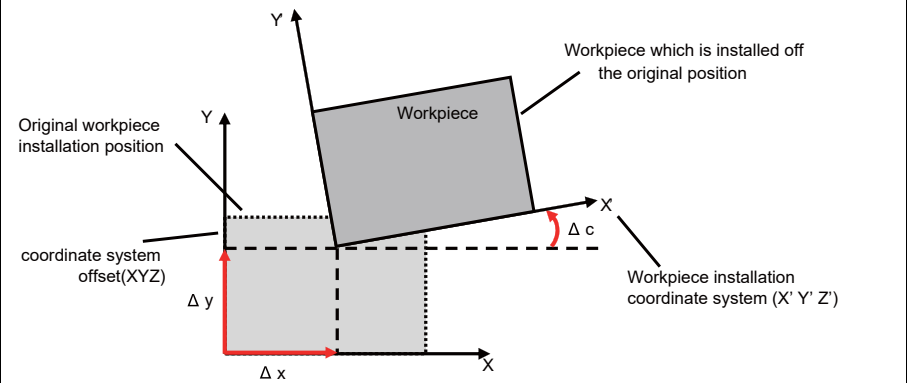
| Display items                                                               | Details                                                                                                                                                                                                                                                                                                                                                                                                                                                                                                                                                                                                                                                                                                                                                                                                                                                                                                                                                                                                                                                                                                                                                                                                                                                                                                                                                                                                                                                                                                                                                                                                                                                                                                                                                                                                                                                                                                                                                                                                                                                                                                                                                                                  |                                              |                                                |                 |  |                                 |   |           |                                                |  |  |           |                                                |  |  |           |                                                |                                                          |   |          |                       |  |  |          |                       |
|-----------------------------------------------------------------------------|------------------------------------------------------------------------------------------------------------------------------------------------------------------------------------------------------------------------------------------------------------------------------------------------------------------------------------------------------------------------------------------------------------------------------------------------------------------------------------------------------------------------------------------------------------------------------------------------------------------------------------------------------------------------------------------------------------------------------------------------------------------------------------------------------------------------------------------------------------------------------------------------------------------------------------------------------------------------------------------------------------------------------------------------------------------------------------------------------------------------------------------------------------------------------------------------------------------------------------------------------------------------------------------------------------------------------------------------------------------------------------------------------------------------------------------------------------------------------------------------------------------------------------------------------------------------------------------------------------------------------------------------------------------------------------------------------------------------------------------------------------------------------------------------------------------------------------------------------------------------------------------------------------------------------------------------------------------------------------------------------------------------------------------------------------------------------------------------------------------------------------------------------------------------------------------|----------------------------------------------|------------------------------------------------|-----------------|--|---------------------------------|---|-----------|------------------------------------------------|--|--|-----------|------------------------------------------------|--|--|-----------|------------------------------------------------|----------------------------------------------------------|---|----------|-----------------------|--|--|----------|-----------------------|
| <p>(1) Workpiece installation error compensation amount<br/>(Continued)</p> | <p>(c) Error in the rotation direction of each axis (<math>\Delta a</math>, <math>\Delta b</math>, <math>\Delta c</math>)<br/>                     Set <math>\Delta a</math>, <math>\Delta b</math>, and <math>\Delta c</math> to determine the XYZ directions of the workpiece installation coordinate system. Compared to the original workpiece coordinate system, the workpiece installation coordinate system's X axis is rotated by the angle <math>\Delta a</math>, Y axis is rotated by the angle <math>\Delta b</math>, and Z axis is rotated by the angle <math>\Delta c</math>.<br/>                     The positive direction of the rotation angle is the right-handed rotation.</p> <p>(d) Table rotary axis position when measuring the errors<br/>                     Set the machine coordinate values of the table rotary axis when <math>\Delta x</math>, <math>\Delta y</math>, <math>\Delta z</math>, <math>\Delta a</math>, <math>\Delta b</math>, and <math>\Delta c</math> are measured.<br/>                     The setting is not required for the machine configuration which does not have the table rotary axis.<br/>                     Two axes should be set for 5-axis machine table tilt type.<br/>                     Axis name to be displayed in the rotary axis 1 and 2 differs depending on the machine configuration.</p> <ul style="list-style-type: none"> <li>◆Table tilt type<br/>                             Displays the axis name #7942 ROTAXW1 for "Rotary axis1", the axis name #7952 ROTAXW2 for "Rotary axis 2"</li> <li>◆Tool tilt type<br/>                             The axis name "#7922 ROTAXT1" will be displayed for "rotary axis 1", and the axis name "#7932 ROTAXT2" will be displayed for "rotary axis 2".</li> <li>◆Combined type<br/>                             The axis name "#7932 ROTAXT2" will be displayed for "rotary axis 1", and the axis name "#7952 ROTAXW2" will be displayed for "rotary axis 2".</li> </ul>  <p>&lt;Note&gt;<br/>                     ◆XYZ are set for the basic axis IJK in this example.</p> |                                              |                                                |                 |  |                                 |   |           |                                                |  |  |           |                                                |  |  |           |                                                |                                                          |   |          |                       |  |  |          |                       |
| <p>(2) Common workpiece installation error offset amount</p>                | <p>You can set the error amount which is commonly added to the seven sets of the error amount corresponding to the compensation No. commanded with address P for the workpiece installation error (G54.4P1 to G54.4P7) in this area.</p> <p>Details of displayed contents are as follows:</p> <table border="0" data-bbox="606 1568 1356 1736"> <tr> <td>(a) Workpiece installation coordinate system</td> <td>→</td> <td><b>G54.4Com</b></td> <td></td> </tr> <tr> <td>(b) Error in the XYZ directions</td> <td>{</td> <td><b>dx</b></td> <td>0.000 ← <math>\Delta x</math>(Error in the X directions)</td> </tr> <tr> <td></td> <td></td> <td><b>dy</b></td> <td>0.000 ← <math>\Delta y</math>(Error in the Y directions)</td> </tr> <tr> <td></td> <td></td> <td><b>dz</b></td> <td>0.000 ← <math>\Delta z</math>(Error in the Z directions)</td> </tr> <tr> <td>(c) Table rotary axis position when measuring the errors</td> <td>{</td> <td><b>A</b></td> <td>0.000 ← Rotary axis 1</td> </tr> <tr> <td></td> <td></td> <td><b>C</b></td> <td>0.000 ← Rotary axis 2</td> </tr> </table> <p>(a) Workpiece installation coordinate system<br/>                     Displays the error amount which is commonly added to the seven sets of the error amount corresponding to the compensation No. commanded with address P for the workpiece installation error (G54.4P1 to G54.4P7).</p> <p>(b) Errors in the XYZ directions (<math>\Delta x</math>, <math>\Delta y</math>, <math>\Delta z</math>)<br/>                     Refer to the display item (1) "Workpiece installation error compensation amount".</p> <p>(c) Table rotary axis position when measuring the errors<br/>                     Refer to the display item (1) "Workpiece installation error compensation amount".</p> <p>&lt;Note&gt;<br/>                     ◆Error in the rotation direction of each axis (<math>\Delta a</math>, <math>\Delta b</math>, <math>\Delta c</math>) cannot be set.</p>                                                                                                                                                                                                          | (a) Workpiece installation coordinate system | →                                              | <b>G54.4Com</b> |  | (b) Error in the XYZ directions | { | <b>dx</b> | 0.000 ← $\Delta x$ (Error in the X directions) |  |  | <b>dy</b> | 0.000 ← $\Delta y$ (Error in the Y directions) |  |  | <b>dz</b> | 0.000 ← $\Delta z$ (Error in the Z directions) | (c) Table rotary axis position when measuring the errors | { | <b>A</b> | 0.000 ← Rotary axis 1 |  |  | <b>C</b> | 0.000 ← Rotary axis 2 |
| (a) Workpiece installation coordinate system                                | →                                                                                                                                                                                                                                                                                                                                                                                                                                                                                                                                                                                                                                                                                                                                                                                                                                                                                                                                                                                                                                                                                                                                                                                                                                                                                                                                                                                                                                                                                                                                                                                                                                                                                                                                                                                                                                                                                                                                                                                                                                                                                                                                                                                        | <b>G54.4Com</b>                              |                                                |                 |  |                                 |   |           |                                                |  |  |           |                                                |  |  |           |                                                |                                                          |   |          |                       |  |  |          |                       |
| (b) Error in the XYZ directions                                             | {                                                                                                                                                                                                                                                                                                                                                                                                                                                                                                                                                                                                                                                                                                                                                                                                                                                                                                                                                                                                                                                                                                                                                                                                                                                                                                                                                                                                                                                                                                                                                                                                                                                                                                                                                                                                                                                                                                                                                                                                                                                                                                                                                                                        | <b>dx</b>                                    | 0.000 ← $\Delta x$ (Error in the X directions) |                 |  |                                 |   |           |                                                |  |  |           |                                                |  |  |           |                                                |                                                          |   |          |                       |  |  |          |                       |
|                                                                             |                                                                                                                                                                                                                                                                                                                                                                                                                                                                                                                                                                                                                                                                                                                                                                                                                                                                                                                                                                                                                                                                                                                                                                                                                                                                                                                                                                                                                                                                                                                                                                                                                                                                                                                                                                                                                                                                                                                                                                                                                                                                                                                                                                                          | <b>dy</b>                                    | 0.000 ← $\Delta y$ (Error in the Y directions) |                 |  |                                 |   |           |                                                |  |  |           |                                                |  |  |           |                                                |                                                          |   |          |                       |  |  |          |                       |
|                                                                             |                                                                                                                                                                                                                                                                                                                                                                                                                                                                                                                                                                                                                                                                                                                                                                                                                                                                                                                                                                                                                                                                                                                                                                                                                                                                                                                                                                                                                                                                                                                                                                                                                                                                                                                                                                                                                                                                                                                                                                                                                                                                                                                                                                                          | <b>dz</b>                                    | 0.000 ← $\Delta z$ (Error in the Z directions) |                 |  |                                 |   |           |                                                |  |  |           |                                                |  |  |           |                                                |                                                          |   |          |                       |  |  |          |                       |
| (c) Table rotary axis position when measuring the errors                    | {                                                                                                                                                                                                                                                                                                                                                                                                                                                                                                                                                                                                                                                                                                                                                                                                                                                                                                                                                                                                                                                                                                                                                                                                                                                                                                                                                                                                                                                                                                                                                                                                                                                                                                                                                                                                                                                                                                                                                                                                                                                                                                                                                                                        | <b>A</b>                                     | 0.000 ← Rotary axis 1                          |                 |  |                                 |   |           |                                                |  |  |           |                                                |  |  |           |                                                |                                                          |   |          |                       |  |  |          |                       |
|                                                                             |                                                                                                                                                                                                                                                                                                                                                                                                                                                                                                                                                                                                                                                                                                                                                                                                                                                                                                                                                                                                                                                                                                                                                                                                                                                                                                                                                                                                                                                                                                                                                                                                                                                                                                                                                                                                                                                                                                                                                                                                                                                                                                                                                                                          | <b>C</b>                                     | 0.000 ← Rotary axis 2                          |                 |  |                                 |   |           |                                                |  |  |           |                                                |  |  |           |                                                |                                                          |   |          |                       |  |  |          |                       |

**CAUTION**

If the workpiece installation error compensation amount is changed during automatic operation (including during single block stop), the change will be valid from the command in the next block or after several subsequent blocks.

**Menus**

For details, refer to "6.8 Setting Workpiece Coordinate System Offset".

**Setting the workpiece installation error data**

For details, refer to "6.8.1 Setting the Coordinate System Offset Amount".

**Erasing the workpiece installation error data**

For details, refer to "6.8.2 Erasing the Coordinate System Offset Amount".

**Changing the cursor position using tab keys (←/→)**

The counter on which the cursor is displayed can be switched using the tab keys as shown below.

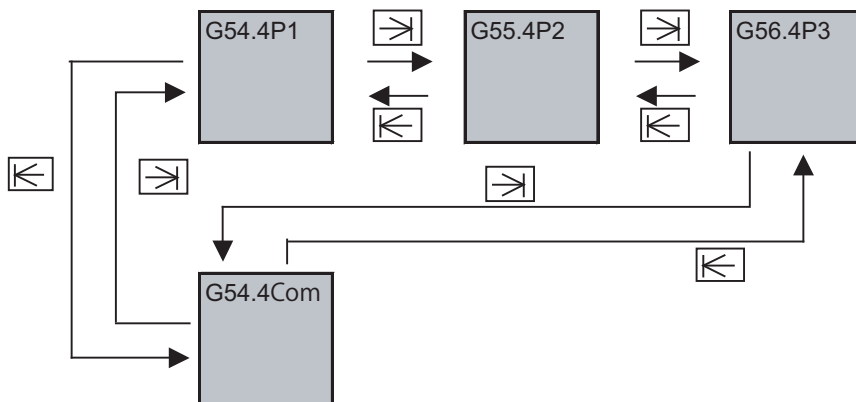

**Changing the counter display using the page up/down keys (previous page: ▲ / next page: ▼)**

The counter display of the workpiece installation error compensation amount can be switched using the page up/down keys as shown below. The cursor moves to "dx" (the first line) when the counter is switched.

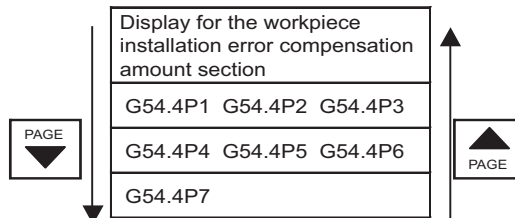

**Changing the input menus to display**

For details, refer to "6.8.5 Changing the Input Menus to Display".

6.8.7 Compensating the Workpiece Position for Rotary Axis

This function can set and display the workpiece position offset for rotary axis controlled by the NC.

This function is an additional specification. This function is available only in the first part system of M system.

Refer to "Programming Manual" for details on this function.

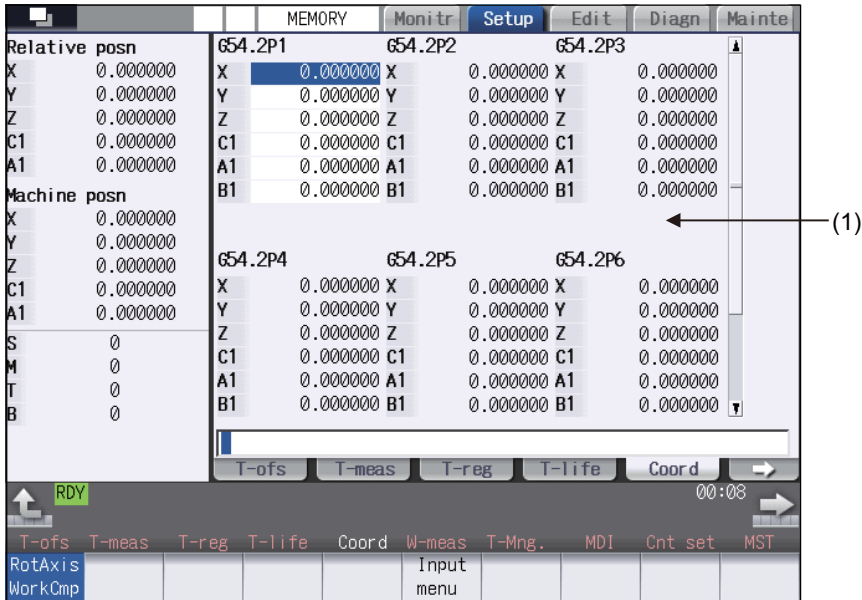

Display items

| Display items                                 | Details                                                                                                                                                                                                                                                                                                  |
|-----------------------------------------------|----------------------------------------------------------------------------------------------------------------------------------------------------------------------------------------------------------------------------------------------------------------------------------------------------------|
| (1) Workpiece position offset for rotary axis | <p>The workpiece position offset amount for rotary axis (G54.2 Pn) can be displayed and set.</p> <p>The workpiece position offset amount for rotary axis can be set in absolute, incremental, or subtracted position.</p> <p>Setting range: - 99999.999 to 99999.999 (mm) ("#1003 iunit"= B, micron)</p> |

**CAUTION**  
 If the workpiece position offset amount for rotary axis is changed during automatic operation (including during single block stop), the change will be valid after the next G54.2 command is issued.

**Menus**

For details, refer to "6.8 Setting Workpiece Coordinate System Offset".

**Setting the workpiece position offset for rotary axis**

For details, refer to "6.8.1 Setting the Coordinate System Offset Amount".

**Erasing the workpiece position offset for rotary axis**

For details, refer to "6.8.2 Erasing the Coordinate System Offset Amount".

**Changing the cursor position using tab keys (← / →)**

The counter on which the cursor is displayed can be switched using the tab keys as shown below.

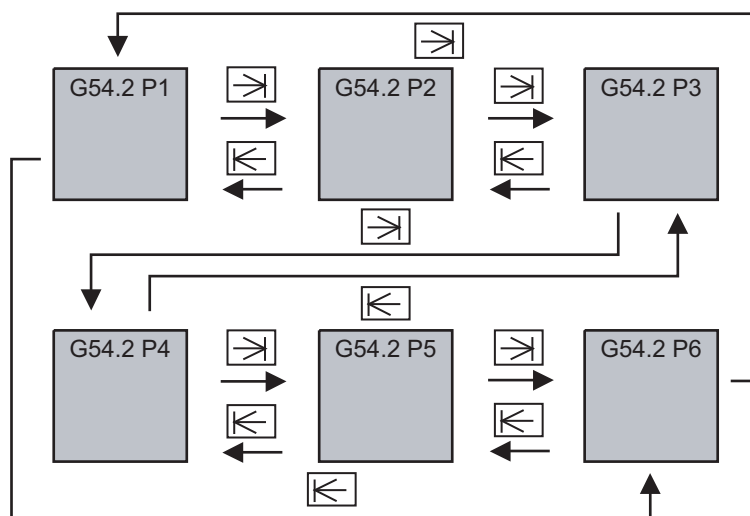

**Changing the counter display using the page up/down keys (previous page:  / next page:  )**

The counter display of the workpiece position offset amount can be switched using the page up/down keys as shown below.

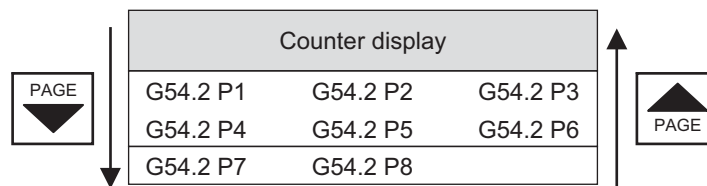

**Changing the displayed axis**

For the function of workpiece position offset for rotary axis, the number of axes that can be displayed simultaneously is 6. To display the subsequent axes, press the menu [Next axis].

**Changing the input menus to display**

For details, refer to "6.8.5 Changing the Input Menus to Display".

### 6.9 Setting Workpiece Coordinate System Shift

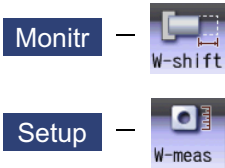

This function allows you to shift the workpiece coordinate system.

Workpiece coordinate system that is created at the machining program creation may not match to the coordinate system that actually programmed or programmed by automatic coordinate system setting. This function allows you to machine without changing the machining program by shifting from the measured coordinate system to the coordinate system that is assumed when the program is created. In addition, workpiece can be machined using the same program even if their shapes are changed.

The workpiece coordinate system shift value can be designated by manual setting or automatic setting.

Manual setting: Allows you to directly input the workpiece coordinate system shift value from the workpiece coordinate system shift screen or select the menu [Measure] to designate the workpiece coordinate system shift value.

Automatic setting: Allows you to designate the workpiece coordinate system shift value with the workpiece measurement signal.

The manual setting and automatic setting to designate the workpiece coordinate system shift value using the menu [Measure] are additional specifications.

When this function is enabled, the menu [W-shift] is displayed on the monitor (Monitr) screen. If the menu [W-meas] is selected on the setup (Setup) screen, the setting screen for the workpiece coordinate system shift screen is displayed.

#### Note

(1) When this function is disabled, the menu [W-shift] is not displayed on the monitor (Monitr) screen. If the menu [W-meas] is selected on the setup (Setup) screen, the external workpiece setting screen is displayed.

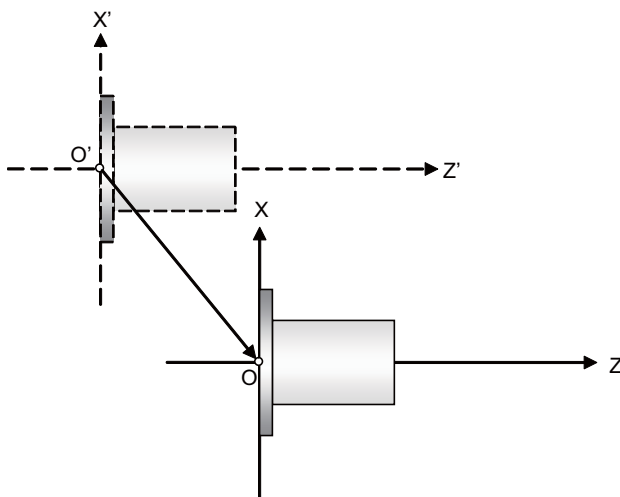

Set the shift value to O'- O as the shift value of the workpiece coordinate system shift value.

X' - Z': Measured coordinate system

X - Z: Coordinate system established when the program is created

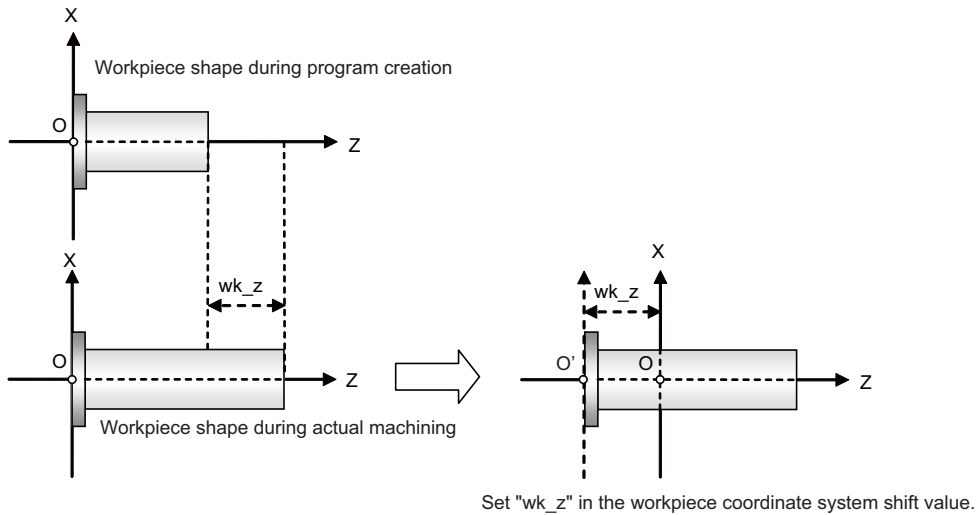

X - Z: Coordinate system established when the program is created

$wk\_z$ : The degree of change of the workpiece shape

<Monitor screen>

The screenshot shows the CNC monitor screen with various data fields and a dialog box. The dialog box is titled "WK coordinate shift" and contains the following data:

| Work shift value | Measure posn |
|------------------|--------------|
| X 0.000          | X 0.000      |
| Z 0.000          | Z 0.000      |
| C 0.000          | C 0.000      |
| A 0.000          | A 0.000      |
| X2 0.000         | X2 0.000     |

Annotations on the screen:

- (5) points to the "Machine posn" table.
- (6) points to the "S1" and "S2" fields.
- (7) points to the "WK coordinate shift" dialog box.



<Setup screen>

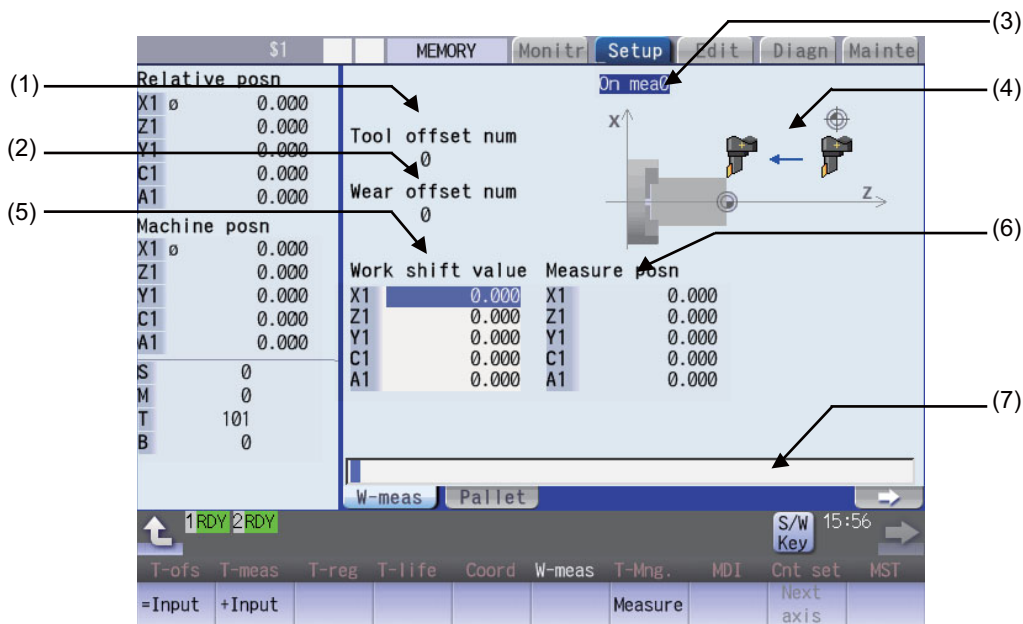

**Display items**

| Display items         | Details                                                                                                                                                                                                                                                                                                                                                                                                                                                             |
|-----------------------|---------------------------------------------------------------------------------------------------------------------------------------------------------------------------------------------------------------------------------------------------------------------------------------------------------------------------------------------------------------------------------------------------------------------------------------------------------------------|
| (1) Tool L offset num | This displays the compensation No. of the tool length data used in the automatic setting. (*1)                                                                                                                                                                                                                                                                                                                                                                      |
| (2) Wear offset num   | This displays the compensation No. of the tool nose wear data used in the automatic setting. (*2)                                                                                                                                                                                                                                                                                                                                                                   |
| (3) On mea            | When the measurement switch is ON and the operation mode is manual mode (handle, jog, rapid traverse, or step), "On mea" is displayed, and the workpiece can be measured by the workpiece coordinate system shift write mode signal. (*3)                                                                                                                                                                                                                           |
| (4) Guide graphic     | This displays the measurement area.                                                                                                                                                                                                                                                                                                                                                                                                                                 |
| (5) Work shift value  | This displays the currently designated workpiece coordinate system shift value. (*4)<br>The initial cursor position is located at the 1st axis in all part systems.<br>If the cursor position is changed using cursor movement keys or the menu [Next axis], it is held until the program is placed into the following status.<br>Monitor screen: The cursor position is not held.<br>Setup screen: The cursor position is held until the power is turned on again. |
| (6) Meas posn         | The measurement position (machine position - tool length compensation amount of the T-commanded tool) is displayed. (*4)                                                                                                                                                                                                                                                                                                                                            |
| (7) Input section     | This displays the input data.                                                                                                                                                                                                                                                                                                                                                                                                                                       |

(\*1) If an illegal value is set, the value is blank ("0" is displayed).



(\*2) If an illegal value is set or tool nose wear data is not used for measurement (parameter "#1226 aux10/bit0" is "1"), the value is blank ("0" is displayed).

(\*3) When the workpiece coordinate offset measurement specification is invalid, the value is not displayed during measurement even if the measurement switch is set ON.

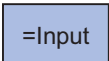
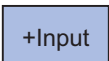
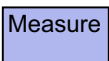

(\*4) To display the 9th axis and after, use the menu [Next axis].

## Menus

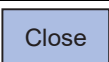
<Monitor screen>

| Menus                                                                             | Details                                                                                                                                                                                                                                                                       |
|-----------------------------------------------------------------------------------|-------------------------------------------------------------------------------------------------------------------------------------------------------------------------------------------------------------------------------------------------------------------------------|
|  | This executes an absolute input.<br>When the parameter "#8929 Disable=INPUT:comp" is set to "1", this menu is disabled.                                                                                                                                                       |
|  | This executes an incremental input.                                                                                                                                                                                                                                           |
|  | The workpiece coordinate system shift value is measured.                                                                                                                                                                                                                      |
|  | This changes the workpiece shift value and the axes displayed at the measurement position on a 8-axis basis. The cursor of the workpiece shift value then jumps to the top row.<br><br><Note><br>•When nine or more axes are included in a part system, this menu is enabled. |
|  | This closes the pop-up window and quits this function.                                                                                                                                                                                                                        |

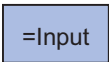
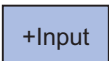
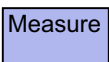
<Setup screen>

| Menus                                                                               | Details                                                                                                                                                                                                                                                                       |
|-------------------------------------------------------------------------------------|-------------------------------------------------------------------------------------------------------------------------------------------------------------------------------------------------------------------------------------------------------------------------------|
|    | This executes an absolute input.<br>When the parameter "#8929 Disable=INPUT:comp" is set to "1", this menu is disabled.                                                                                                                                                       |
|   | This executes an incremental input.                                                                                                                                                                                                                                           |
|  | The workpiece coordinate system shift value is measured.                                                                                                                                                                                                                      |
|  | This changes the workpiece shift value and the axes displayed at the measurement position on a 8-axis basis. The cursor of the workpiece shift value then jumps to the top row.<br><br><Note><br>•When nine or more axes are included in a part system, this menu is enabled. |

## 6.9.1 Manually Setting the Workpiece Coordinate System Shift Value

**Operation method (Set the absolute position "10.000" to the workpiece coordinate system shift value of the Z axis (2nd axis) on the Monitor screen.)**

- |                                                                                                                                                                        |   |                                                                     |
|------------------------------------------------------------------------------------------------------------------------------------------------------------------------|---|---------------------------------------------------------------------|
| (1) This displays the workpiece coordinate system shift.<br><Monitor screen><br>Press the menu [W-shift].<br><Setup screen><br>Press the menu [W-meas].                | ➔ | The workpiece coordinate system shift screen is displayed.          |
| (2) Use the [↑] or [↓] key to move the cursor onto the Z axis.                                                                                                         | ➔ | The cursor moves to the Z axis.                                     |
| (3) Designate the workpiece coordinate system shift value.<br>10 [INPUT]<br>The value can also be designated by pressing the menu [=Input] instead of the [INPUT] key. | ➔ | The designated value appears.<br>The cursor moves to the next axis. |

**Note**

- (1) If the parameter "#11017 T-ofs set at run" (Tool compensation amount setting during automatic operation enabled) is set to "1", the workpiece coordinate system shift value can also be designated in the automatic operation mode or operation pause mode.

**Operation method (Add the value "1.234" to the workpiece coordinate system shift value of the C axis (3rd axis) on the Monitor screen.)**

- |                                                                                                                                                         |   |                                                                                                                                                               |
|---------------------------------------------------------------------------------------------------------------------------------------------------------|---|---------------------------------------------------------------------------------------------------------------------------------------------------------------|
| (1) This displays the workpiece coordinate system shift.<br><Monitor screen><br>Press the menu [W-shift].<br><Setup screen><br>Press the menu [W-meas]. | ➔ | The workpiece coordinate system shift screen is displayed.                                                                                                    |
| (2) Use the [↑] or [↓] key to move the cursor onto the C axis.                                                                                          |   |                                                                                                                                                               |
| (3) Input a numeric value.<br>1.234 [+Input]                                                                                                            | ➔ | The input value added to the original value is displayed.<br>(Example) When the original value is set to "10.000",<br>"10.000 + 1.234 = 11.234" is displayed. |

**Note**

- (1) If the parameter "#11017 T-ofs set at run" (Tool compensation amount setting during automatic operation enabled) is set to "1", the workpiece coordinate system shift value can also be designated in the automatic operation mode or operation pause mode.



**Operation method (Measure the workpiece coordinate system shift value of the Z axis (2nd axis) on the Monitor screen.)**

- (1) Select the basic tool used to measure the workpiece shift value with the manual numerical value command.  The Manual numerical value command screen is displayed, and tool 1003 is selected.
- T1003  
The T command can also be issued with MDI operation, etc. If one block contains multiple T commands, the last T command is used as the selected tool.

- (2) This displays the workpiece coordinate system shift.  The workpiece coordinate system shift screen is displayed.
- <Monitor screen>  
Press the menu [W-shift].  
<Setup screen>  
Press the menu [W-meas].

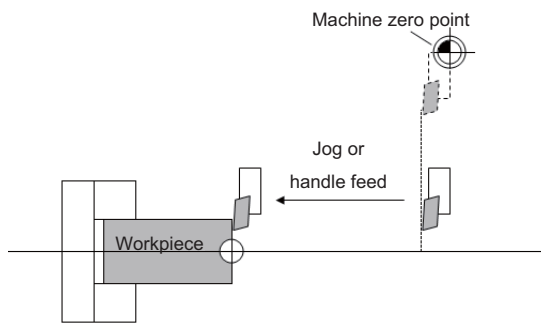
- (3) Select the "Manual handle feed" mode or "Jog feed" mode.
- (4) Select the Z axis, and manually move the tool to the work end face (program origin).



- (5) Input the name of the axis to be measured, and the measurement value from the workpiece to the tool nose.  When you input "Z0", the cursor moves to the Z axis column. Value "Z0." is displayed in the input column. If you input an axis name that does not exist, the cursor does not move. The second and subsequent characters are not considered to be the axis name and, therefore, the cursor does not move. (Example: If you enter "XZ", the cursor is moved on the X axis, but the cursor does not move on the Z axis.)
- Z0.
- (6) Press the menu [Measure].  The measurement result is set to the workpiece coordinate system shift value pointed by the cursor. The input column is cleared.

<Details on formula>

The measurement result is calculated in the following formula.

When the parameter "#8709 Ext work sign rvs" is set to "0":

|                                                                                                                       |
|-----------------------------------------------------------------------------------------------------------------------|
| Measurement result = (Machine position of Z axis) - (Tool length compensation data of T-command tool) - (Input value) |
|-----------------------------------------------------------------------------------------------------------------------|

When the parameter "#8709 Ext work sign rvs" is set to "1":

|                                                                                                                       |
|-----------------------------------------------------------------------------------------------------------------------|
| Measurement result = (Machine position of Z axis) - (Tool compensation data of T-command tool) * (-1) - (Input value) |
|-----------------------------------------------------------------------------------------------------------------------|

Select the tool compensation data used for the measurement with the parameter "#1226 aux10/bit0".

| #1226 aux10/bit0 | Tool compensation data            |
|------------------|-----------------------------------|
| 0                | Tool length data + nose wear data |
| 1                | Tool length data                  |

### Note

- (1) If the parameter "#11017 T-ofs set at run" (Tool compensation amount setting during automatic operation enabled) is set to "1", the tool compensation amount data can be input in the automatic operation mode or operation pause mode.
- (2) If you press the menu [Measure] while the axis name designated in the input section is different from that pointed at the cursor, the operation message "Setting error " is displayed.

## 6.9.2 Automatically Setting the Workpiece Coordinate System Shift Value

Carry out the automatic setting for the workpiece coordinate system shift value using the workpiece measurement signal. The PLC device is set to the value of the 1st part system. For information on how to carry out automatic setting in another part system, refer to the PLC Interface Instruction Manual.

**Operation method**

- |     |                                                                                                                                                                                                                                                                                                                       |   |                                                                                                                                                                                                                                                                                                                |
|-----|-----------------------------------------------------------------------------------------------------------------------------------------------------------------------------------------------------------------------------------------------------------------------------------------------------------------------|---|----------------------------------------------------------------------------------------------------------------------------------------------------------------------------------------------------------------------------------------------------------------------------------------------------------------|
| (1) | Carry out the reference position return.<br>If the workpiece is measured without establishing the reference position return, the operation message "Meas axis not returned to ref. position" appears. However, when the setup workpiece coordinate system shift screen is not displayed, the message will not appear. | ➔ | After the power is turned on, carry out the dog-type reference position return, and establish the coordinate system.<br>In the absolute position detection specification, configure the initial setting in advance if the absolute position is not established.                                                |
| (2) | Select the mode.                                                                                                                                                                                                                                                                                                      | ➔ | Set the mode selection switch to the manual mode (handle, jog, rapid traverse, or step).                                                                                                                                                                                                                       |
| (3) | Input the tool measurement mode signal (YC21).                                                                                                                                                                                                                                                                        | ➔ | Set the tool length measurement signal to "1". "On mea" is displayed on the setup workpiece coordinate system shift screen.                                                                                                                                                                                    |
| (4) | Select the main or sub part system.                                                                                                                                                                                                                                                                                   | ➔ | Select whether to measure the workpiece coordinate system shift value on the main spindle side or sub-spindle side by using tool presetter sub-side valid signal (YCD-A).<br>Hold the status of this signal until the workpiece coordinate system shift value measurement with the selected tool is completed. |
| (5) | Select a tool.<br><br>Set the selected tool compensation No. in R register. The set R register differs according to parameter setting and the state of the tool presetter sub-side valid signal. Set the "tool length/wear data" for the tool being used beforehand.                                                  | ➔ | Issue the T command by MDI operation, etc., then select tool.                                                                                                                                                                                                                                                  |
| (6) | Cut the workpiece face.<br>If the workpiece does not need to be cut, carry out positioning to the measurement position.                                                                                                                                                                                               | ➔ | If the workpiece face is not cut, cut the workpiece face slightly to even it.<br>Do not move the tool in the Z axis direction after cutting the workpiece face.                                                                                                                                                |
| (7) | Input the workpiece measurement signal (Y9E1).                                                                                                                                                                                                                                                                        | ➔ | Input the workpiece measurement signal. The Z axis external workpiece coordinate offset data is automatically calculated from the tool compensation data of the used tool and the machine value at the point this signal is input. The results are set as the data.                                            |

<Details on automatic calculation expression>

The workpiece coordinate system shift value is automatically calculated with the following expression:

When the parameter "#8709 Ext work sign rvs" is set to "0":

Workpiece coordinate system shift amount = Machine coordinate value - Tool compensation data

When the parameter "#8709 Ext work sign rvs" is set to "1":

Workpiece coordinate system shift value = -(Machine coordinate value - Tool compensation data) \* (-1)

Select the tool compensation data used for the measurement with the parameter "#1226 aux10/bit0".

| #1226 aux10/bit0 | Tool compensation data            |
|------------------|-----------------------------------|
| 0                | Tool length data + nose wear data |
| 1                | Tool length data                  |

<Compensation No. of selected tool>

The compensation number of the tool length and nose wear data used for automatic calculation is determined by the PLC ladder.

<Note>

- When the compensation No. is 0, the compensation amount will be calculated as "0".
- If the compensation No. exceeds the number of specified offset sets, the operation message "Offset No. not found" appears. However, when the setup workpiece coordinate system shift screen is not displayed, the message will not appear.
- If the input data exceeds the setting range, the operation message "Data range error" appears. However, when the setup workpiece coordinate system shift screen is not displayed, the message will not appear.
- If the data protection is valid, the operation message "Data protect" appears. However, when the setup workpiece coordinate system shift screen is not displayed, the message will not appear.
- Measurement is disabled for the part system with one-axis structure. The operation message "Can't measure" is displayed. However, when the setup workpiece coordinate system shift screen is not displayed, the message will not appear.
- Whether to use the main side or sub-side is selected with the tool presetter sub-side valid signal (YCDA). (OFF: Main side, ON: Sub-side)

- (8) Set the tool length measurement signal to OFF.  The measurement of the workpiece coordinate system shift value is completed.  
Select the tool compensation data used for the measurement with the parameter "#1226 aux10/bit0".

### Precautions

- (1) When the automatic setting is carried out for the workpiece coordinate system shift value without displaying the setup workpiece coordinate system shift screen, the message is not displayed even if an error occurs.

## 6.10 Measuring the Workpiece Installation Error Data



The workpiece installation error measurement screen is to measure the workpiece installation error and to set error offset amount. By setting the information of the workpiece to be measured or touch probe, etc. to be used for measurement in advance, the movement of the touch probe, reading the coordinate and calculation of the error are performed automatically. Also, you can set the calculated error to the offset amount of the specified workpiece installation coordinate system G54.4 Pn (n = 1 to 7).

This screen is displayed only when the additional specification of workpiece installation error compensation is valid in M system. This screen is a function for each part system.

### Measurement procedure

#### (1) Place the workpiece and touch probe

Place the workpiece on the table and set each rotary axis to 0°. In this state, manually move the touch probe to one third of X width from the end surface of the workpiece on X negative side and one third of Y width from the end surface of the workpiece on Y negative side as in the figure below. Moreover, manually move the touch probe close to the workpiece just until it contacts the workpiece from Z axis positive direction.

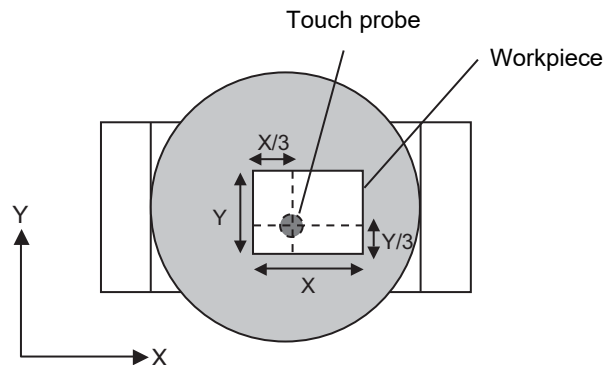

#### (2) Setting the measurement conditions

Press the menu [Measure cond.] on the workpiece installation error measurement screen to set the information of the touch probe or workpiece to be used for measurement and the common variable to store the measurement result.



## (3) Perform the measurement

After pressing the menu [Start measure] to set it to the measurement state, perform cycle start. After the measurement is started, automatically measure three points each for (1) to (3) on the top face, (4) to (6) on the left side face and (7) to (9) on the front face as in the figure below. After the measurement is completed, the calculated installation error is displayed on the screen.

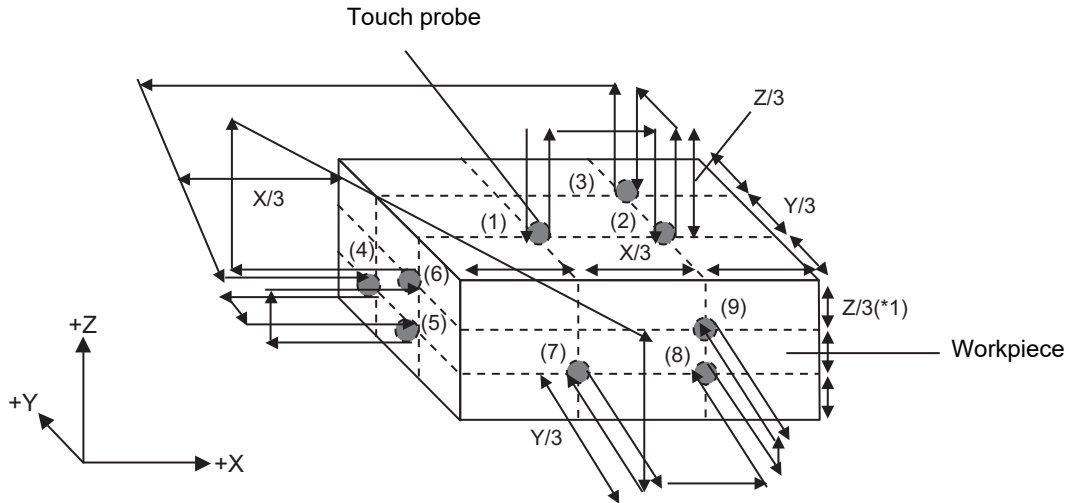

## (4) Setting the measurement result

Press the menu [Write WK err.] to set the measurement result displayed on the screen to the offset amount of the workpiece installation coordinate system G54.4Pn set in the measurement condition.

**Measurement operation descriptions**

Press the cycle start to measure three points each on the top face, side face and front face (five faces when the workpiece zero point is the workpiece center) and the workpiece installation error is calculated.

**■ Measure from the top face**

Measure three points on the top face to calculate the inclination on the top face.

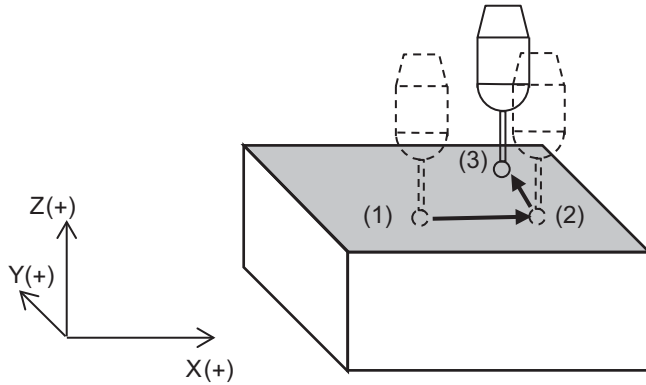
**■ Measure from the side face**

Measure three points on the side face to calculate the inclination on the side face.

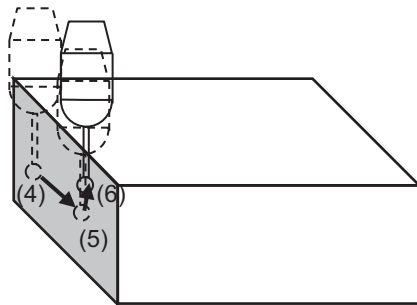
**■ Measure from the front face**

Measure three points on the front face to calculate the inclination on the front face.

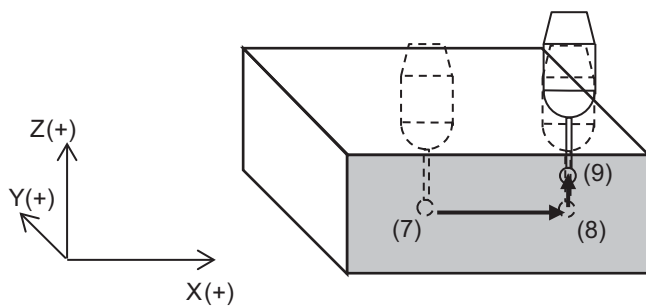

On each measurement point, after contacting the touch probe to the workpiece with skip operation, separate the touch probe from the workpiece once and then measure the coordinate on the workpiece with decelerated skip operation.

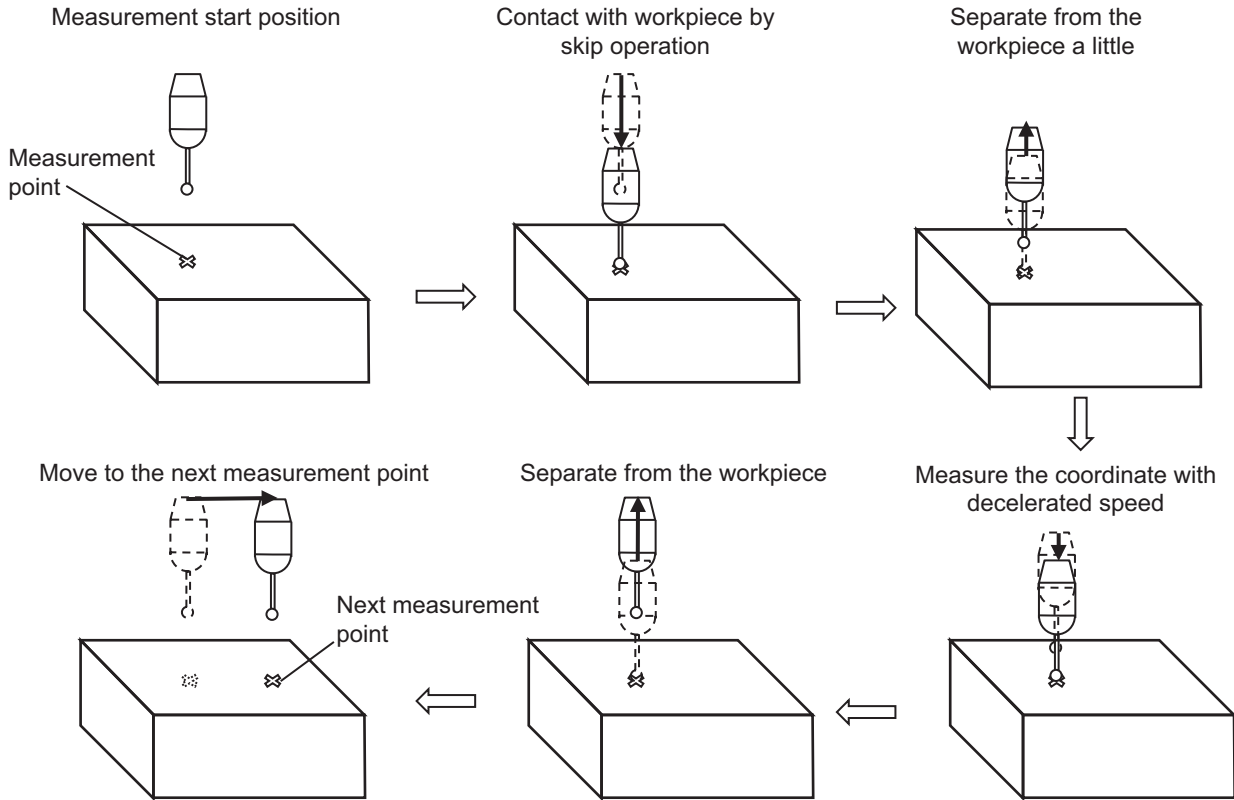

The measurement is started from the position one third away from each side in the direction perpendicular to the measurement face for each measurement point.

When the measurement face is switched, the touch probe moves at  $Z/3$  height from the top face of workpiece.

If the workpiece is greatly tilted and the height error between the measurement points on the same face is  $Z/3$  or more, the sensor may be damaged.

When the width in the X, Y, Z direction of the workpiece is X, Y, Z respectively, the sensor tip moves as in the following (1) to (9).

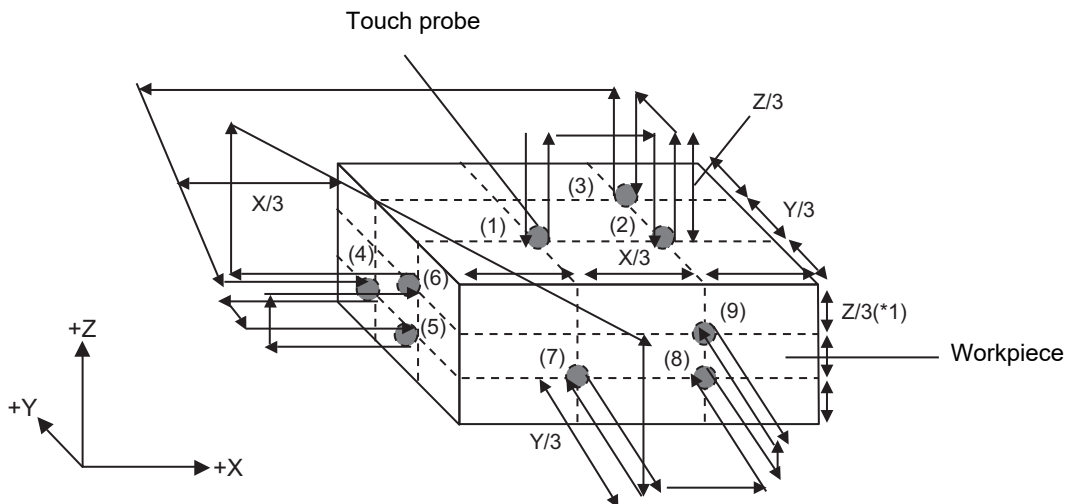

**Note**

(1) Assuming that the Z direction width of the workpiece is Z and the stylus length is S, when S is smaller than Z, the measurement height of side face and front face become S third and S \* two third from the top face.

Depending on which point on the workpiece the workpiece zero point is set on, the face to be measured is switched between the left face/right face, or front face/back face.

Selectable workpiece zero point position (0 to 4)

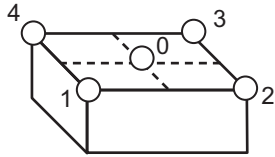

Switching measurement face at each workpiece zero point position

Workpiece zero point position: 0

Measurement face: top, left, back, right and front

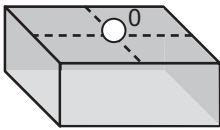

Workpiece zero point position: 1

Measurement face: top, left and front

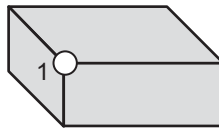

Workpiece zero point position: 2

Measurement face: top, right and front

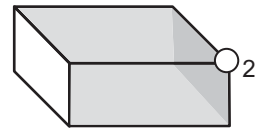

Workpiece zero point position: 3

Measurement face: top, right and back

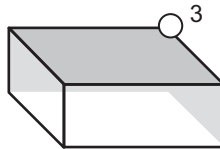

Workpiece zero point position: 4

Measurement face: top, left and back

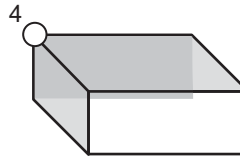

When the workpiece is greatly tilted, confirm the measurement face in the figure on the previous page and set the workpiece zero point so that the stylus bar portion does not contact the workpiece.

Tilted workpiece

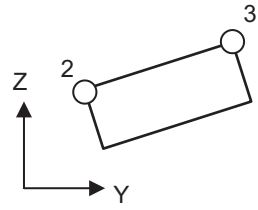
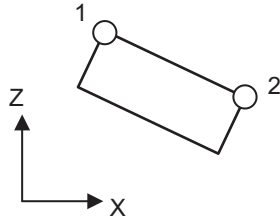
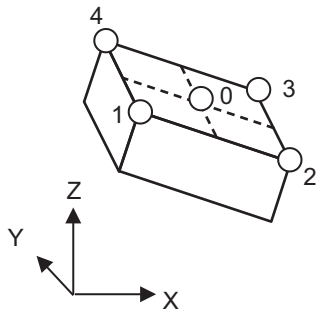

Measure with Workpiece zero point position: 1

Top

Left

Front

The stylus bar portion contacts the workpiece angle before the stylus ball contacts the face.

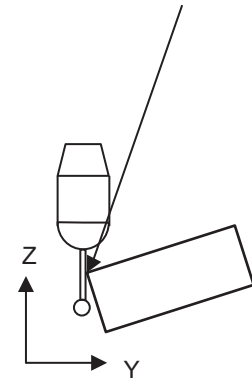
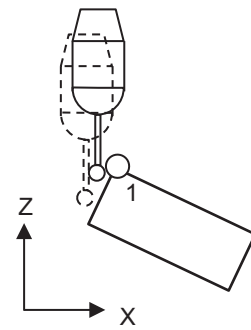
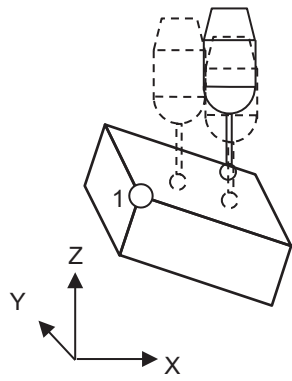

Measure with Workpiece zero point position: 4

Top

Left

Back

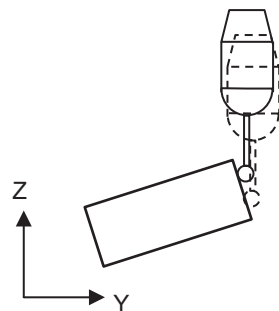
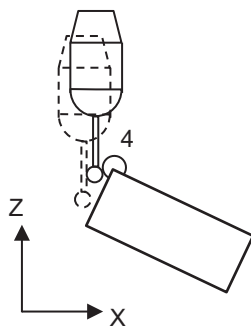
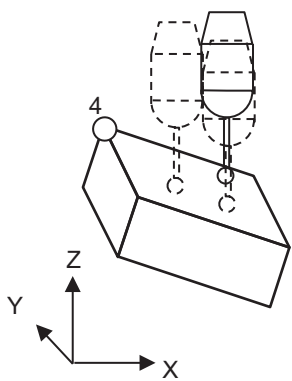

## Parameter setting examples

Example of parameter setting when measuring with the following configuration.

**[Sensor information]**

Touch probe: OMP60 (Renishaw)

Stylus sphere diameter: 5 mm

Stylus length: 50 mm

Over travel amount: 21 mm (in XY direction), 11 mm (in Z direction)

Tool length: 176 mm

**[Workpiece information]**

X width: 70 mm

Y width: 100 mm

Z width: 40 mm

**[NC setting information]**

Tool length: Set the sensor tool length (176 mm) to tool No. 2

Common variable No. to be used: 800 to 807

Destination for writing error compensation amount: G54.4 P3

Workpiece coordinate: G54.1 P5

Workpiece zero point: Center of the workpiece

## Parameter setting examples

| Parameter No. | Details                                                              | Value |
|---------------|----------------------------------------------------------------------|-------|
| #11700        | Starting common variable No. for storage of error measurement result | 800   |
| #8717         | WE measure wk zero                                                   | 0     |
| #8718         | WE meas. wk coord                                                    | 54.1  |
| #8719         | WE meas. ext wk No                                                   | 5     |
| #8720         | WE mea. wk X-width                                                   | 70    |
| #8721         | WE mea. wk Y-width                                                   | 100   |
| #8722         | WE mea. wk Z-width                                                   | 40    |
| #8723         | WK inst. err comp#                                                   | 3     |
| #8724         | Sensor T L comp No                                                   | 2     |
| #19101        | Stylus sphere dia.                                                   | 5     |
| #19102        | Stylus length                                                        | 50    |
| #19103        | Sensor over-travel                                                   | 11    |

6.10.1 Screen Configuration

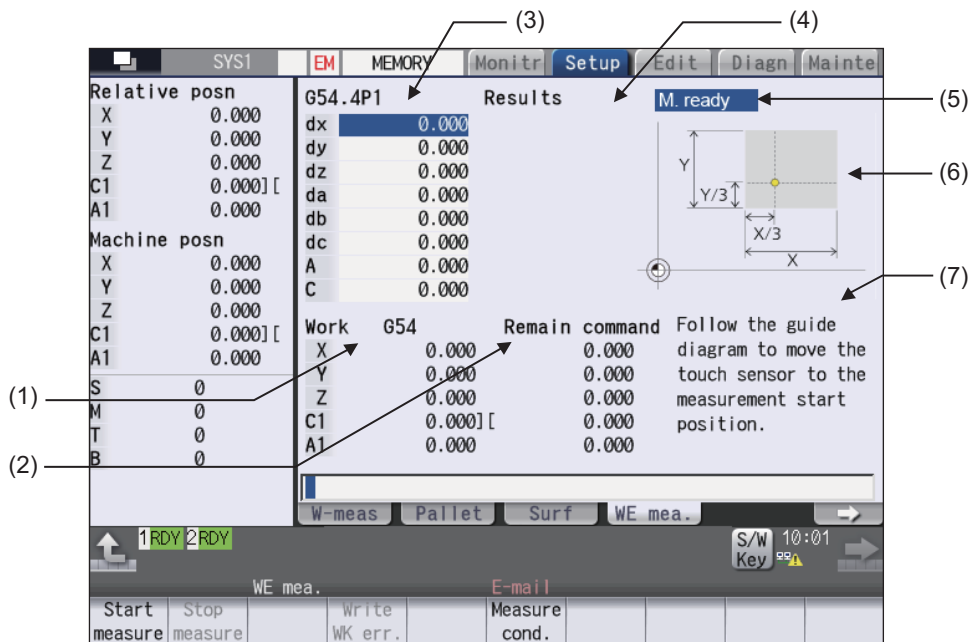

Display items

| Display items                                        | Details                                                                                                                                                                                                                                                                                                                                                                                                      |
|------------------------------------------------------|--------------------------------------------------------------------------------------------------------------------------------------------------------------------------------------------------------------------------------------------------------------------------------------------------------------------------------------------------------------------------------------------------------------|
| (1) Workpiece coordinate G54 counter                 | This displays the workpiece coordinate G54 counter.                                                                                                                                                                                                                                                                                                                                                          |
| (2) Remaining command counter                        | This displays the remaining command counter.                                                                                                                                                                                                                                                                                                                                                                 |
| (3) Workpiece installation error compensation amount | This displays the error offset amount of the workpiece installation coordinate system (G54.4Pn) corresponding to the set workpiece installation error No. Also, the error offset amount can be set.<br><br>For details, refer to "Display items" of "6.8.6 Compensating the Workpiece Installation Error Data".                                                                                              |
| (4) Measurement result                               | This displays the measurement result of workpiece installation error.<br><br><Note><br><ul style="list-style-type: none"> <li>•This displays the value of eight sets of common variables from the head No. of common variable set in the measurement condition.</li> </ul>                                                                                                                                   |
| (5) Measurement status                               | This displays the status of the followings according to the measurement status. <ul style="list-style-type: none"> <li>•M. ready<br/>This shows the measurement can be executed.<br/>When the cycle start is performed in this state, the measurement is started.</li> <li>•On mea<br/>This shows the measurement is in progress.</li> <li>•Complete<br/>This shows the measurement is completed.</li> </ul> |
| (6) Guide graphic                                    | This displays the installation position of touch probe when the measurement is started.                                                                                                                                                                                                                                                                                                                      |
| (7) Guidance                                         | This displays the guidance related to the measurement.                                                                                                                                                                                                                                                                                                                                                       |

| Menus         |                                                                                                                                                                              |
|---------------|------------------------------------------------------------------------------------------------------------------------------------------------------------------------------|
| Menus         | Details                                                                                                                                                                      |
| Start measure | The measurement is ready. When the cycle start is performed in this state, the measurement is started. When the measurement is completed, the measurement result is updated. |
| Stop measure  | This interrupts the measurement. When the measurement is interrupted, the measurement result is not updated.                                                                 |
| Write WK err. | This sets the measurement result to the workpiece installation error offset amount of the specified No.                                                                      |
| Measure cond. | This displays the pop-up window to set the measurement condition.                                                                                                            |

### 6.10.2 Setting the Measurement Condition

When the menu [Measure cond.] is selected, the pop-up window appears. Set the information of the workpiece and touch probe to be used for the measurement.

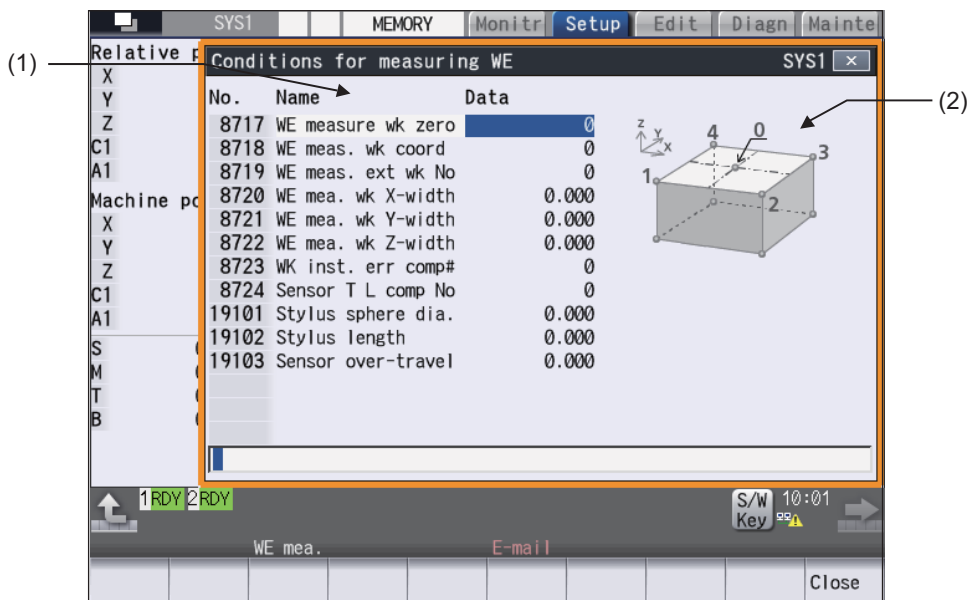



**Display items**

| Display items                        | Details                                                                                                                                                                                                              |
|--------------------------------------|----------------------------------------------------------------------------------------------------------------------------------------------------------------------------------------------------------------------|
| (1) Measurement condition parameters | This sets the parameters required for the measurement.                                                                                                                                                               |
| WE measure wk zero                   | This sets the workpiece zero point No.<br>Setting range: 0 to 4                                                                                                                                                      |
| WE meas. wk coord                    | This sets the workpiece zero point setting position at the time of the workpiece installation error measurement.<br>Setting range: 0 to 4                                                                            |
| WE meas. ext wk No                   | This sets No. after P of G54.1 when the workpiece coordinate of the workpiece where the workpiece installation error measurement is performed is extended workpiece coordinate system.<br>Setting range: 0, 54 to 59 |
| WE mea. wk X-width                   | This sets the width in X direction of the workpiece. (*1)<br>Setting range: 0.000 to 99999.999 (mm)                                                                                                                  |
| WE mea. wk Y-width                   | This sets the width in Y direction of the workpiece. (*1)<br>Setting range: 0.000 to 99999.999 (mm)                                                                                                                  |
| WE mea. wk Z-width                   | This sets the width in Z direction of the workpiece. (*1)<br>Setting range: 0.000 to 99999.999 (mm)                                                                                                                  |
| WK inst. err comp#                   | This sets the workpiece installation error No. to write the measurement result. (Example) For G54.4P1, set "1".<br>Setting range: 0 to 7                                                                             |
| Sensor T L comp No                   | This sets the offset No. of the touch probe to be used for the measurement. (Figure (c) below)<br>Setting range: 0 to 999                                                                                            |
| Stylus sphere dia.                   | This sets the diameter of stylus sphere of the touch probe. (Figure (a) below)<br>Setting range: 0.000, 1.000 to 10.000 (mm)                                                                                         |
| Stylus length                        | This sets the length of stylus of the touch probe. (Figure (b) below)<br>Setting range: 0.000 to 99999.999 (mm)                                                                                                      |
| Sensor over-travel                   | This sets the over travel amount (over travel allowance amount and over stroke) of the sensor to be used for the measurement. (Figure (d) below)<br>Setting range: 0.000 to 100.000 (mm)                             |
| (2) Guide graphic                    | This displays the guide drawing of workpiece zero point position.                                                                                                                                                    |

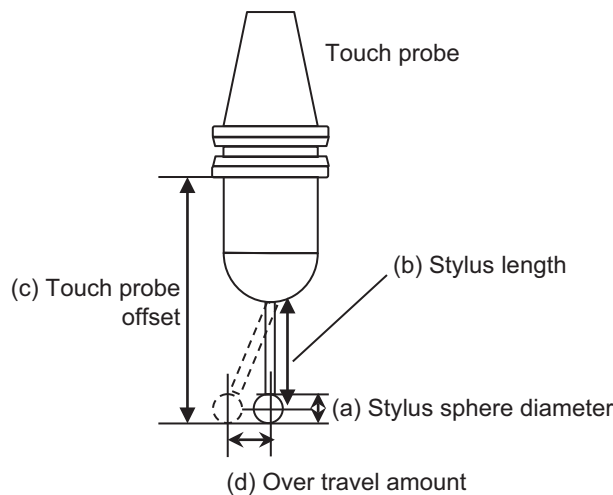





(\*1) If the range where the touch probe can be contacted is small due to the jog, etc., specify the width of the part outside the jig.

**Operation method**

- (1) Press the menu [Measure cond.].
- (2) Set the workpiece installation error No.  The numerical value input to the workpiece installation error No. is set. The cursor moves to the next line.  
With the cursor at the workpiece installation error No., input the numerical value and press [INPUT] key.  
(Example) 3 [INPUT]
- (3) In the same way, set each measurement condition.  
After the setting is completed, select the menu [Close] to close the pop-up window.

## 6.10.3 Performing Workpiece Installation Error Measurement

**Operation method (Performing the measurement)**

- (1) According to the guide graphic, move the touch probe manually to the measurement start position.
- (2) Press the menu [Start measure].  "M. Ready" is displayed in the measurement state. "EM" is displayed in the NC status.
- (3) Press the cycle start button.  The measurement status becomes "On mea" and the measurement is performed automatically.  
When the measurement is completed, the measurement result is updated. Also, "Complete" is displayed in the measurement status and the NC status "EM" disappears.
- (4) Press the menu [Write WK err.].  The confirmation message "OK to write measurement results?(Y/N)" appears.
- (5) Press the [Y] or [INPUT] key.  The measurement result is set to the offset amount of the workpiece installation coordinate system G54.4Pn set in the measurement condition.

**Note**

- (1) Confirm the skip signal (X6F8) is input when the touch probe is contacted before the measurement is performed. If the measurement is performed in the state that the skip signal cannot be input, the touch probe may be damaged.
- (2) If reset or emergency stop is performed during the measurement, the measurement is interrupted. In this case, the measurement result is not updated.
- (3) If the menu [Start measure] is pressed during the automatic operation, the operation message "Executing automatic operation" is displayed and the measurement is not started.
- (4) If the menu [Write WK err.] is pressed during the automatic operation, the operation message "Executing automatic operation" is displayed and the offset amount cannot be set.
- (5) If the offset amount of the workpiece coordinate system G54.4Pn (n=1 to 7) during the measurement, the operation message "Executing automatic operation" is displayed and the offset amount cannot be set.
- (6) When the workpiece installation error measurement is performed in multiple part systems continuously, write the error after error measurement before starting the measurement in the next part system. If the next measurement is started without writing the error, the last measurement result is lost.

**Operation method (Canceling the measurement)**

- |                                    |   |                                                                                                                                                                                        |
|------------------------------------|---|----------------------------------------------------------------------------------------------------------------------------------------------------------------------------------------|
| (1) Press the menu [Stop measure]. | ➔ | The menu [Stop measure] is highlighted and the confirmation message "Is it OK to discontinue measure?(Y/N)" is displayed.                                                              |
| (2) Press the [Y] or [INPUT] key.  | ➔ | The measurement preparation state is canceled. Also the highlight of the menu [Stop measure] is canceled and the NC status "EM" and the measurement status display "On mea" disappear. |

## 6.10.4 Precautions for Workpiece Installation Error Measurement

**Availability of check mode with other functions**

This section explains regarding the operation when the workpiece installation error measurement is performed with other functions.

Depending on the combination, the sensor may be damaged or the error may not be calculated correctly.

**■Function where the coordinate system changes**

When the function where the coordinate system changes is valid, the workpiece installation error measurement cannot be performed correctly. If performed, the sensor may be damaged or the error may not be calculated correctly.

Do not perform the workpiece installation error measurement combined with the following functions.

- Polar coordinate interpolation (G12.1)
- External workpiece coordinate offset (The setting value is not "0".)
- Local coordinate system (G52)
- Origin set
- Workpiece position offset for rotary axis (G54.2)
- Workpiece coordinate system shift
- Coordinate rotation by program (G68)
- Coordinate rotation by parameter
- 3-dimensional coordinate conversion (G68)
- Polar coordinate command (G16)
- Tool center point control (G43.4, 43.5)
- Inclined surface machining command (G68.2)
- R-navi (during the surface selection, during indexing)

**■Function where the path changes**

When the function where the path changes is valid, the workpiece installation error measurement cannot be performed correctly. If performed, the sensor may be damaged or the error may not be calculated correctly.

Do not perform the workpiece installation error measurement combined with the following functions.

- Tool length compensation (G43, 44)
- Tool position compensation (G43.7)
- Tool radius compensation (G38, 39, 41, 42)
- 3-dimensional tool radius compensation (G41.2, 42.2)
- Nose R (G41, 42, 46)
- Scaling (G51)
- The parameter setting mirror image
- Mirror image by external input
- Mirror image (G50.1)
- Normal line control (G41.1, 42.1)
- Workpiece installation error compensation (G54.4)

**■Function where the axes switch**

When the function where the axes switch is valid, the workpiece installation error measurement cannot be performed correctly. If performed, the sensor may be damaged or the error may not be calculated correctly.

Do not perform the workpiece installation error measurement combined with the following functions.

- ◆Axis name change
- ◆Mixed control (cross axis control)
- ◆Arbitrary axis exchange control
- ◆Control axis superimposition
- ◆Arbitrary axis superimposition control

**■Buffer correction**

Buffer correction cannot be executed while the workpiece installation error measurement is performed.

**■Restart search**

Restart search cannot be executed for the workpiece installation error measurement. If executed, the restart search is executed for the program before the workpiece installation error measurement is performed.

**■Collation and stop**

Collation and stop cannot be executed for the workpiece installation error measurement.

**■Chopping**

If the workpiece installation error measurement is performed during chopping, the sensor may be damaged. Error is not calculated correctly.

**■3D machine interference check**

If the tool length of the sensor is not set to the tool length of 3D interference check, the sensor may be damaged or the measurement may be stopped.

**Precautions**

- (1) Confirm the skip signal is input with the touch probe before the workpiece installation error measurement is performed. If the workpiece installation error measurement is performed in the state that the skip signal cannot be input, the sensor may be damaged.
- (2) When "0006 H/W stroke end axis exists" occurs, change the setting position of the workpiece.
- (3) When "0007 S/W stroke end axis exists" occurs, correct the parameter soft limit I (#2013 and #2014). Also, change the setting position of the workpiece.  
If the workpiece installation error measurement is performed in the following state, the measurement is performed in the state that the compensation is valid, the sensor may be damaged and the measurement result may not be correct.
  - When the coordinate system is shifted due to manual interruption with manual absolute OFF
  - When the compensation by the coordinate system shift such as local coordinate system setting, workpiece coordinate system shift and external workpiece offset, various coordinate conversions or various offsets is valid
- (4) If the workpiece installation error measurement is performed in the state that the parameter where the compensation is applied to the coordinate system such as the mirror image by parameter setting, mirror image by external input and coordinate rotation by parameter, the measurement is performed in the state that the compensation is valid, the sensor may be damaged and the measurement result may not be correct.
- (5) Single block stop cannot be performed during the workpiece installation error measurement.
- (6) Perform the measurement in the state that the measured machine error compensation amount is set to the compensation data and the machine error compensation is valid.
- (7) Measurement related parameters cannot be changed during cycle start. When changing the measurement related parameters, cancel the measurement before changing them.
- (8) When changing the mode to the one other than memory mode in the state "On mea", the operation error "M01 Invalid op mode in err measure 0246" occurs and the manual interruption, automatic operation handle interruption, MDI interruption, etc. cannot be performed. After changing the mode to the memory mode, press the cycle start button to restart the error measurement.
- (9) When the measurement macro is initialized or the measurement is started, do not change the parameter "#11701 WEM Mcr No" (Macro No. for workpiece installation error measurement). If changed, the sensor may be damaged.
- (10) After the error measurement is completed, if the next measurement is started without writing the error, press the menu [Stop measure] to stop the measurement and then press the menu [Start measure].
- (11) The workpiece installation error measurement can be performed when the axis names are X, Y and Z only. With other axis configuration, the measurement cannot be performed.
- (12) This function does not support multiple part systems.

# 7

---

## Setting Parameters

The parameters contain the user and machine parameters.

This chapter explains the details and operations for the user parameters on the Setup screen.

Refer to "Alarm/Parameter Manual" for details of each parameter.

Parameters can be set on the maintenance (Mainte) screen.

### 7.1 Setting User Parameters



Press the menu [User] on the Setup screen to display various user parameters.

Display example by part system (Switch the part system using the  $\$ \leftrightarrow \$$  key.)

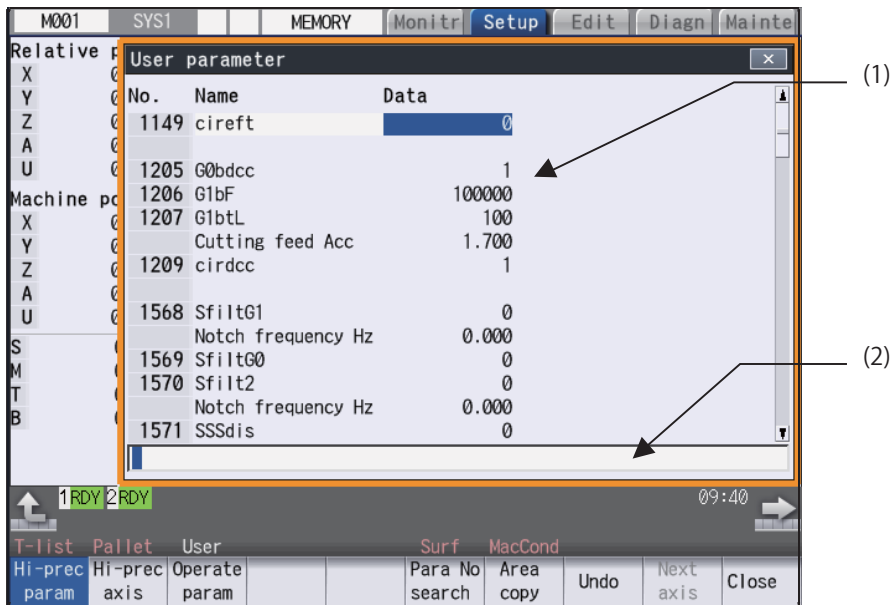

Display example by axis (Switch the fourth axis and after on the menu [Next axis].)

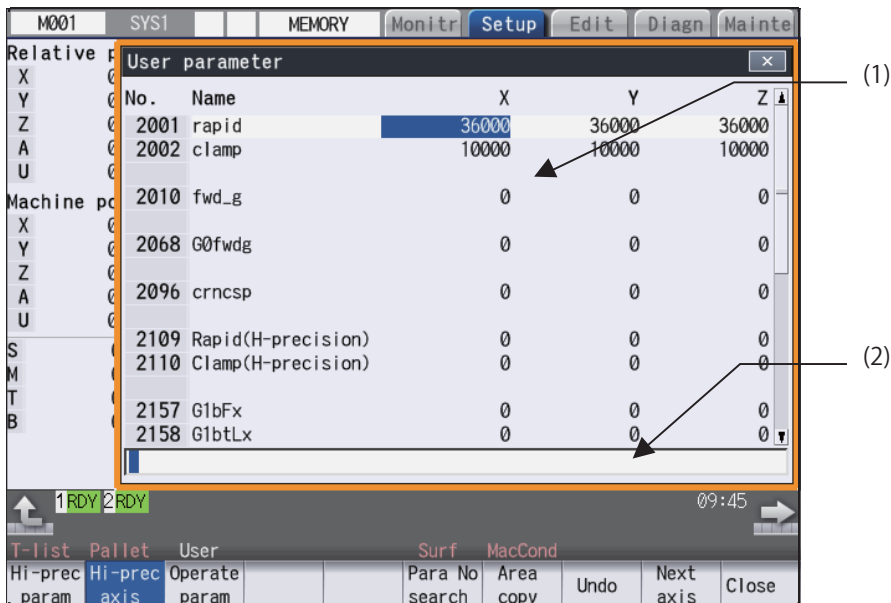

Display example by part system/axis



Display items

| Display items              | Details                                                                                                                                                                                           |
|----------------------------|---------------------------------------------------------------------------------------------------------------------------------------------------------------------------------------------------|
| (1) Parameter display area | Press the parameter selection menu [Process param] or [Hi-prec param] etc. to change the parameter display contents. The screen layout can be switched by part system (with [\$] key) or by axis. |
| (2) Input section          | The set key displays. Press the [INPUT] key to set the display data in the parameter where the cursor is located.                                                                                 |



## Menus

| Menus          | Details                                                                                                                                                                                                                                                                                                                                                                                                                                                                                                                                                                                                                                                                                                     |
|----------------|-------------------------------------------------------------------------------------------------------------------------------------------------------------------------------------------------------------------------------------------------------------------------------------------------------------------------------------------------------------------------------------------------------------------------------------------------------------------------------------------------------------------------------------------------------------------------------------------------------------------------------------------------------------------------------------------------------------|
| Process param  | This changes the display of each parameter type.<br><Note>                                                                                                                                                                                                                                                                                                                                                                                                                                                                                                                                                                                                                                                  |
| Fixed cycle    | <ul style="list-style-type: none"> <li>♦ The barrier data appears only for L system.</li> <li>♦ [Menu select] is displayed only when the parameter "#11032 Menu sel para lkof " (Menu select param setting enabled) is set to "1" or "2".</li> </ul>                                                                                                                                                                                                                                                                                                                                                                                                                                                        |
| Ctrl param 1   |                                                                                                                                                                                                                                                                                                                                                                                                                                                                                                                                                                                                                                                                                                             |
| Ctrl param 2   |                                                                                                                                                                                                                                                                                                                                                                                                                                                                                                                                                                                                                                                                                                             |
| I/O param      |                                                                                                                                                                                                                                                                                                                                                                                                                                                                                                                                                                                                                                                                                                             |
| Ethernet param |                                                                                                                                                                                                                                                                                                                                                                                                                                                                                                                                                                                                                                                                                                             |
| Link param     |                                                                                                                                                                                                                                                                                                                                                                                                                                                                                                                                                                                                                                                                                                             |
| Subpro stor    |                                                                                                                                                                                                                                                                                                                                                                                                                                                                                                                                                                                                                                                                                                             |
| Axis param     |                                                                                                                                                                                                                                                                                                                                                                                                                                                                                                                                                                                                                                                                                                             |
| Barrier data   |                                                                                                                                                                                                                                                                                                                                                                                                                                                                                                                                                                                                                                                                                                             |
| Hi-prec param  |                                                                                                                                                                                                                                                                                                                                                                                                                                                                                                                                                                                                                                                                                                             |
| Hi-prec axis   |                                                                                                                                                                                                                                                                                                                                                                                                                                                                                                                                                                                                                                                                                                             |
| Operate param  |                                                                                                                                                                                                                                                                                                                                                                                                                                                                                                                                                                                                                                                                                                             |
| Menu select    |                                                                                                                                                                                                                                                                                                                                                                                                                                                                                                                                                                                                                                                                                                             |
| Toleran param  |                                                                                                                                                                                                                                                                                                                                                                                                                                                                                                                                                                                                                                                                                                             |
| Para No search | This selects an arbitrary parameter number. Set the parameter number and press the [INPUT] key to move that number to the top and display the parameter. The cursor also moves to that number.                                                                                                                                                                                                                                                                                                                                                                                                                                                                                                              |
| Area copy      | This copies the parameter setting values in the designated range. The range is designated with numbers.<br>When the range is not designated, this copies the value of the parameter pointed by the cursor.<br>After copying, the menu will be changed to [Area paste].                                                                                                                                                                                                                                                                                                                                                                                                                                      |
| Area paste     | This pastes the range of parameters designated by [Area copy] to the corresponding parameters of the axis or part system pointed by the cursor.<br>After pasting, the confirmation message "Change the menu back to Area copy?(Y/N)" appears. Press the [Y] or [INPUT] key to go back to [Area copy]. When pressing the any key other than [Y] or [INPUT], the paste-enabled state will remain and you can continue pasting by pressing the menu [Area paste].<br><Note> <ul style="list-style-type: none"> <li>♦ While the confirmation message "Paste?(Y/N)" is displayed, the menu will be highlighted.</li> <li>♦ To go back to [Area copy] without pasting, switch the parameter type once.</li> </ul> |

| Menus     | Details                                                                                                                                                                                                    |
|-----------|------------------------------------------------------------------------------------------------------------------------------------------------------------------------------------------------------------|
| Undo      | This returns the last rewritten data to its previous value.<br><Note><br>• When the parameter "#8939 Undo confirm msg" is set to "1", the menu is highlighted while the confirmation message is displayed. |
| Next axis | This can be selected if the total number of part system display axes is 4 or more. This is used at the parameter screen with the array structure for each axis.                                            |
| Close     | This closes the pop-up window and quits this function.                                                                                                                                                     |

### 7.1.1 Selecting the Parameter Number

There are two switching methods to display a screen by designating the parameter No. Use the parameter "#8975 No. search process" to switch the operation

#### Operation method ("#8975 No. search process" is "0") (Select "#1041 Initial inch")

- (1) Press the menu [Para No search].
- (2) Enter a parameter No. to be displayed, and then press the [INPUT] key.  "#1041 Initial inch" is displayed at the head. The cursor moves to "#1041 Initial inch".  
1041 [INPUT]

#### Operation method ("#8975 No. search process" is "1") (Select "#1041 Initial inch")

- (1) Enter a parameter No. to be displayed.  
1041
- (2) Press the menu [Para No search].  "#1041 Initial inch" is displayed at the head. The cursor moves to "#1041 Initial inch".

#### Note

- (1) When the parameter "#8975 No. search process" is set to "1" and the cursor is at the parameter to be echoed back, the set value is displayed in the input column. Delete the set value in the input column, and then perform the menu [Para No search] operation.

### 7.1.2 Setting the Parameters

The method of setting the parameters is explained. Refer to "Alarm/Parameter Manual" for details of each parameter setting range.

#### Operation method (Normal) (Set "100" for Y1 axis of "#2001 rapid")

- (1) Press the menu [Hi-prec axis].
- (2) Use the [↑], [↓], [←] and [→] keys to move the cursor to the setting position.
- (3) Input the value.  
100 [INPUT]

#### Operation method (Batch data setting) (Set "4000" for Y1 axis and "3000" for Z1 axis for "#2002 clamp")

- (1) Press the menu [Hi-prec axis].
- (2) Use the [↑], [↓] keys to move the cursor to the setting position.
- (3) Input the value.  
Input format: 1st column/2nd column/3rd column  
/4000/3000 [INPUT]

#### Note

- (1) When a parameter is changed and [PR] displays at the top of the screen, reboot the machine to enable that parameter change.
- (2) When the [INPUT] key is pressed without inputting a value, the parameter setting value is not changed, and the cursor moves.
- (3) Parameters that can be set simultaneously must display within the currently displayed three columns.
- (4) If parameter values are simultaneously input in multiple columns, settings are made from the currently displayed column on the left side, no matter which column the cursor is positioned.
- (5) When the data protection is valid, the value cannot be set (including paste operation) for the high-accuracy control parameters (part system based), high-accuracy control axis parameters and tolerance parameters.

### 7.1.3 Copying and Pasting Parameters

Parameters can be copied and pasted in a parameter with the same number for another axis or part system.

#### Operation method (Specifying and copying the parameter where the cursor is located)

- (1) Press the menu [Area copy].
- (2) Move the cursor to the position of the parameter to be copied and press the [INPUT] key.  Copying position is displayed in the selected area color. (If you move the cursor, the highlighted position can be confirmed.)  
The menu highlight returns to normal and the menu will be changed to [Area paste].







#### Operation method (Copying parameter numbers in a specific range)

- (1) Move the cursor to the display area of the axis or part system to be copied.
- (2) Press the menu [Area copy].
- (3) Designate the copy range.  The range to be copied is displayed in the selected area color.  
Format: First No./Last No.  
8701/8705 [INPUT]  
An "E" can be used if the last number to be copied is the last number in the currently displayed parameter type.  
(Example) 8701/E  
The menu highlight returns to normal and the menu will be changed to [Area paste].

#### Note

- (1) The copy range remains enabled immediately before you change the parameter type. If you change the parameter type, the menu returns to [Area copy].
- (2) Only the currently displayed parameter type can be copied.

**Operation method (Pasting the copied parameters)**

- (1) Move the cursor to the axis or part system display area where the data will be pasted.
- (2) Press the menu [Area paste].  The menu will be highlighted and the confirmation message "Paste?(Y/N)" appears.
- (3) Press the [Y] or [INPUT] key.  The copied data is written to the parameter with the same number in the area where the cursor is positioned. The menu highlight returns to normal and the confirmation message "Change the menu back to Area copy?(Y/N)" appears.
- When the keys other than [Y] or [INPUT] are pressed, the data will not be written.
- <When returning to copying operation>
- (4) Press the [Y] or [INPUT] key.  The selected area color of the range to be copied will return to the previous color. The menu will be changed to [Area copy].
- <When continuing to copy>
- (4) Press a key other than [Y] or [INPUT].  The range to be copied remains the selected area color. The menu remains [Area paste].
- (5) Move the cursor to the display area of the axis or the part system to be pasted and then press the menu [Area paste].  The menu will be highlighted and the confirmation message "Paste?(Y/N)" appears.
- (6) Press the [Y] or [INPUT] key.  The copied data is written to the parameter with the same number as the copy source in the area pointed by the cursor. The operation after this is the same as (3).



**Note**

- (1) If the relevant parameter is changed after specifying the range to be copied, the value after the change is pasted.

**7.1.4 Undoing the Parameter Change**

This can undo the last rewritten parameter.

The input data can be returned to the previous value. By pressing the menu [Undo] again, the previous value is changed back to the value that you last input.

- (1) Input the value in the area pointed by the cursor.  The setting value is displayed and the cursor moves.
- (2) Press the menu [Undo].  The cursor returns to the original position and the value before setting is displayed.

**Note**

- (1) Even when the multiple axes data are set simultaneously using "/", all the data will be returned to the previous values before the setting.
- (2) The undo operation remains enabled until the screen or the parameter type is changed.
- (3) When the operation parameter "#8939 Undo confirm msg" is set to "1", the menu [Undo] is highlighted and the confirmation message "OK?(Y/N)" appears. The program returns to the previous status by pressing [Y] or [INPUT] key. If any key other than [Y] or [INPUT] is pressed, the operation to undo will be canceled. When the operation is canceled, the menu highlight returns to normal and the message disappears.

## 7.1.5 Parameter Configuration

The parameter number range and permissible operations for all parameter types are shown below.

○: Can be used      Δ: Operable under certain conditions (Refer to the section below for conditions.)

| Parameter type                        | Menu [Next axis] | System change key | Menu [Area copy] | Menu [Area paste] |
|---------------------------------------|------------------|-------------------|------------------|-------------------|
| Fixed cycle parameter                 | -                | Δ (*3)            | Δ (*3)           | Δ (*3)            |
| Fixed cycle                           | -                | Δ (*3)            | Δ (*3)           | Δ (*3)            |
| Control parameter 1                   | -                | -                 | -                | -                 |
| Control parameter 2                   | -                | Δ (*3)            | Δ (*3)           | Δ (*3)            |
| I/O parameter                         | -                | -                 | -                | -                 |
| Ethernet parameter                    | -                | -                 | -                | -                 |
| Computer link parameter               | -                | -                 | -                | -                 |
| Subprogram storage location parameter | -                | Δ (*3)            | Δ (*3)           | Δ (*3)            |
| Axis parameter                        | Δ (*1)           | -                 | Δ (*2)           | Δ (*2)            |
| Barrier data (*4)                     | -                | Δ (*3)            | ○                | ○                 |
| High-accuracy control parameter       | -                | Δ (*3)            | Δ (*3)           | Δ (*3)            |
| High-accuracy control axis parameter  | Δ (*1)           | -                 | Δ (*2)           | Δ (*2)            |
| Operation parameter                   | -                | -                 | -                | -                 |
| Menu selection parameter              | -                | -                 | -                | -                 |
| Tolerance parameter                   | Δ (*1)           | Δ (*3)            | Δ (*3)           | Δ (*3)            |

(\*1) This is valid only when the total number of valid NC axes and PLC axes in the entire part system is four or more.

(\*2) This is valid only when the total number of valid NC axes and PLC axes in the entire part system is two or more.

(\*3) This is valid only when the number of valid part systems is two or more.

(\*4) The barrier data appears only for L system.

## 7.1.6 Echoback

When 13 or more characters are set for Ethernet parameter to be echoed back, the set value is displayed in the input area and displayed in the data column with "...". When the cursor moves to a parameter which is not subject to echoback, the contents in the input area will be deleted.

Parameter to be a target of echo back

| Type                                  | No.  | Parameter name                     | Remarks                                                                                                      |
|---------------------------------------|------|------------------------------------|--------------------------------------------------------------------------------------------------------------|
| Ethernet parameter                    | 9711 | Host1 host name                    | The parameters which set "Host1" to "Host4" are also the target of the echoback.                             |
|                                       | 9712 | Host1 user name                    |                                                                                                              |
|                                       | 9714 | Host1 directory                    |                                                                                                              |
|                                       | 9811 | StartFilterIP LAN1-1               | The parameters which set "LAN1-2" to "LAN1-8", and "LAN2-1" to "LAN2-8" are also the target of the echoback. |
|                                       | 9812 | EndFilterIP LAN1-1                 |                                                                                                              |
| Subprogram storage location parameter | 8881 | Subprogram storage location D0:dir | The parameters which set the device 1 to the device 4 (D1 to D4) are also the target of the echoback.        |

### 7.1.7 Ethernet parameter

If the Ethernet parameter "Host 1 password" to "Host 4 password" is set, "\*\*\*\*\*" displays regardless of the password characters set in that data field.

### 7.1.8 Setting VNC Server Connection Password

If the VNC server connection password is set, "\*\*\*\*\*" is displayed regardless of the number of password setting characters in the data display field.

The details on key operation when inputting the password are saved in the key history as "\*".

For details on the VNC server, refer to "14 Appendix 1: VNC Server Function".

### 7.1.9 Precautions

When the data protection is valid, the value cannot be set (including paste operation) for the high-accuracy control parameters (part system based) and high-accuracy control axis parameters.

## 7.2 Selecting High-accuracy Control Parameters (Machining Cond I Screen)



A machining which meets the machining purpose or machining process can be performed by switching the high-accuracy parameter set according to the machining object on the Machining cond (MacCond) screen.

Multiple sets of high-accuracy parameter (parameter related to the high-accuracy control) can be configured in advance for each machining purpose (such as parts machining or die machining) and machining process (such as rough or finishing).

Procedure for using this function is as follows:

- (1) Initializing the machining condition parameter set
  - Initializing the machining condition parameter set in the "Machining cond" screen
  - Initializing the machining condition parameter set by data input/output
- (2) Setting the machining condition parameter set
  - Set the total of nine sets of machining condition parameter sets of "three applications x three conditions" in the "Machining cond" screen
- (3) Switching the machining condition parameter set
  - Switching the machining condition parameter set in the "Machining cond" screen
  - Switching the machining condition parameter set by G code command in the machining program

MTB password is required for operating this screen.

### Machining condition selection I screen

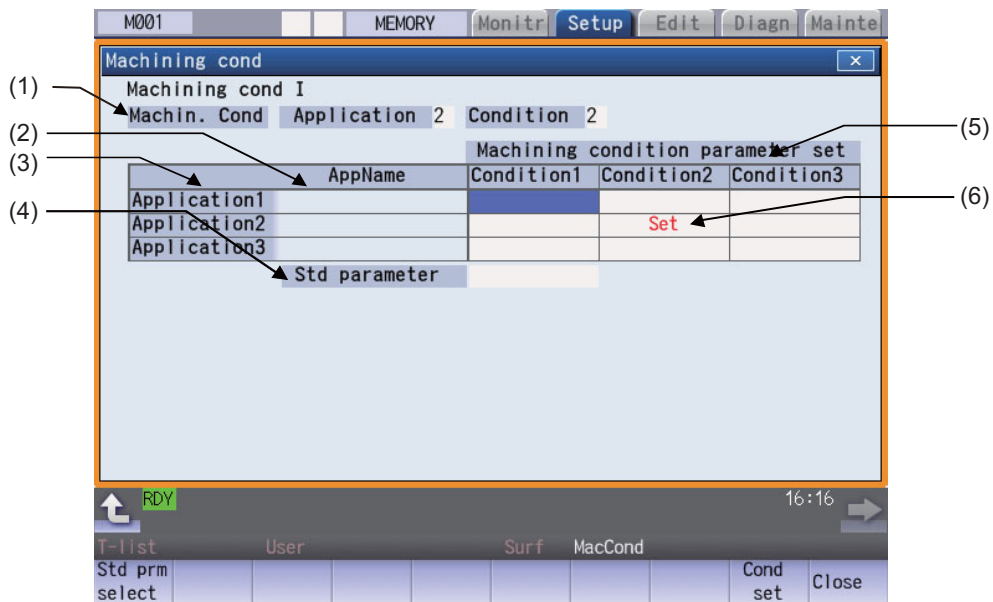



## Display items

| Display items                         | Details                                                                                                                                                                                                                                                                                                                                                           |
|---------------------------------------|-------------------------------------------------------------------------------------------------------------------------------------------------------------------------------------------------------------------------------------------------------------------------------------------------------------------------------------------------------------------|
| (1) During machining condition        | Displays the applications and conditions used for the current machining.<br>This shows No. 0 through 3 of the machining applications and conditions, which you have selected on the [Machining condition selection] screen or switched with a G code command.<br>While standard parameter is being selected, "0" is displayed on the applications and conditions. |
| (2) Application name                  | Displays the application name set in the menu [AppName set] in the "Machining cond screen".                                                                                                                                                                                                                                                                       |
| (3) Application                       | Displays Application 1 to 3.                                                                                                                                                                                                                                                                                                                                      |
| (4) Ref. param                        | "Set" is displayed in this column while the standard parameter is being selected.                                                                                                                                                                                                                                                                                 |
| (5) Machining condition parameter set | Displays the machining condition parameter set of application 1 to 3.<br>"Set" is displayed in the column of the selected machining condition parameter set.                                                                                                                                                                                                      |
| (6) Set                               | "Set" is displayed in the column of the selected machining condition parameter set.<br>It will not update if an application/condition is switched by G code command. It will update when selected on the machining condition selection screen.                                                                                                                    |

## Menus

| Menus            | Details                                                                                                                                                                                                                                                                                                                                                                                                                                   |
|------------------|-------------------------------------------------------------------------------------------------------------------------------------------------------------------------------------------------------------------------------------------------------------------------------------------------------------------------------------------------------------------------------------------------------------------------------------------|
| Std<br>prmselect | Switches machining condition to standard parameter.<br>After the menu is highlighted and the cursor moves to standard parameter, the confirmation message "Change to standard parameters?(Y/N)" will appear. If you press [Y] (or [INPUT]), the status of standard parameter changes to "Set".<br>If you press any key other than [Y] (or [INPUT]), it will be canceled. The cursor will remain on standard parameter even when canceled. |
| Cond<br>set      | Changes to the "Machining cond" screen.<br><Note><br>•MTB password is required for the maintenance screen.                                                                                                                                                                                                                                                                                                                                |
| Close            | This closes the pop-up window and quits this function.                                                                                                                                                                                                                                                                                                                                                                                    |

**Machining condition setting screen**

The machining condition parameter to be displayed is switched by enabling or disabling tolerance control.

<When tolerance control is disabled>

| No.  | Name               | Machining condition parameter set |            |            |
|------|--------------------|-----------------------------------|------------|------------|
|      |                    | Condition1                        | Condition2 | Condition3 |
| 1206 | G1bF               | 30000                             | 30000      | 30000      |
| 1207 | G1btL              | 0                                 | 0          | 0          |
|      | Cutting feed Acc   | 50.986                            | 50.986     | 50.986     |
| 1568 | SfiltG1            | 0                                 | 0          | 0          |
|      | Notch frequency Hz | 0.000                             | 0.000      | 0.000      |
| 1570 | Sfilt2             | 0                                 | 0          | 0          |
|      | Notch frequency Hz | 0.000                             | 0.000      | 0.000      |
| 2010 | fwd_g              | 0                                 | 0          | 0          |
| 8019 | R COMP             | 0                                 | 0          | 0          |
|      | Theor R decrease   | 229.569                           | 229.569    | 229.569    |
|      | R5mm arc dec speed | 94868.422                         | 94868.422  | 94868.422  |
|      | R1mm Arc dec speed | 42426.448                         | 42426.448  | 42426.448  |

<When tolerance control is enabled>

| No.  | Name               | Ref. param | Machining condition parameter set |            |            |
|------|--------------------|------------|-----------------------------------|------------|------------|
|      |                    |            | Condition1                        | Condition2 | Condition3 |
| 1206 | G1bF               | 5000       | 5000                              | 5000       | 5000       |
| 1207 | G1btL              | 50         | 50                                | 50         | 50         |
|      | Cutting feed Acc   | 0.170      | 0.170                             | 0.170      | 0.170      |
| 1568 | SfiltG1            | 50         | 50                                | 50         | 50         |
|      | Notch frequency Hz | 0.000      | 20.000                            | 20.000     | 20.000     |
| 2659 | tolerance          | 5.000      | 5.000                             | 5.000      | 5.000      |

## Display items

| Display items                         | Details                                                                                                                                                                                                                                                                                       |
|---------------------------------------|-----------------------------------------------------------------------------------------------------------------------------------------------------------------------------------------------------------------------------------------------------------------------------------------------|
| (1) Application                       | Displays the application being set.<br>To change to the next machining purpose, press the menu [App change].<br>When machining purpose being selected, the background is emphasized in red.<br>The background is not highlighted while the Standard parameter is selected.                    |
| (2) Parameter No.                     | Displays the number of a standard parameter.                                                                                                                                                                                                                                                  |
| (3) Parameter name                    | Displays the name of a standard parameter.                                                                                                                                                                                                                                                    |
| (4) Ref. param                        | Displays the value of the standard parameter designated on the parameter screen.<br>This item is not displayed when the machining parameter "#12066 Tolerance ctrl ON" is set to "0".<br><br><Note><br>♦"#2659 tolerance" indicates the setting value of the 1st axis in the 1st part system. |
| (5) Machining condition parameter set | Displays three sets of machining condition parameter set which belongs to the application purpose being set.<br>The background of the selected machining condition is highlighted in red.<br>The background is not highlighted while the Standard parameter is selected.                      |

## Menus

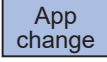
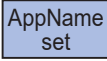
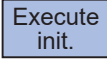
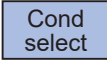
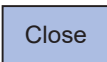
| Menus                                                                               | Details                                                                                                                                                                                                                                                                               |
|-------------------------------------------------------------------------------------|---------------------------------------------------------------------------------------------------------------------------------------------------------------------------------------------------------------------------------------------------------------------------------------|
|   | Switches the application being set to other application.<br>It switches from Application1 -> Application2 -> Application3 -> Application1 -> ... each time this menu key is pressed.                                                                                                  |
|  | Sets the application name for the application being set.<br>The name with up to 12 one-byte characters of numeric, English capital letter, and symbol can be set.<br><br><Note><br>♦However, "\", "/", ", ", "*", "", "<", ">", " ", and "space" cannot be used as a one-byte symbol. |
|  | Copies the setting values corresponding to the standard parameters to the all machining condition parameter sets.                                                                                                                                                                     |
|  | Changes to the machining condition selection screen.                                                                                                                                                                                                                                  |
|  | This closes the pop-up window and quits this function.                                                                                                                                                                                                                                |

## Initializing the machining condition parameter set

(1) Press the menu [MacCond] in the setup screen.

(2) Select the menu [Cond set] in the "Machining cond" screen.

(3) Select the menu [Execute init].

(4) Press the [Y] or [INPUT] key.



The setting value for the standard parameters corresponding to each machining condition parameter will be copied.

**Setting the machining condition parameter set**

- (1) Press the menu [MacCond] in the setup screen.
- (2) Select the menu [Cond set] in the "Machining cond" screen.
- (3) Move the cursor to the position of the parameter to be set.
- (4) Input the value, and then press [INPUT].

**Note**

- (1) It cannot be set without initializing the machining condition parameter set.

**Switching the machining condition parameter set**

- (1) Place the cursor on the position of the machining condition parameter set (application/condition) to be switched in the "Machining cond" screen.
- (2) Press the [INPUT] key.
- (3) Press the [Y] or [INPUT] key.

**Note**

- (1) The machining condition which is selected on the Machining cond screen applies to all part systems.
- (2) When the machining condition parameter set is switched, for the parameter "#2010 fwd\_g" (Feed forward gain) and "#2659 tolerance", the same value is applied to all NC axes in the switched part system.
- (3) For the operation search, the machining condition selection parameter is not switched. For the restart search, the machining condition selection parameter is switched.

**Canceling the machining condition parameter set and switch to standard parameter (Switch by cursor)**

- (1) Move the cursor to the standard parameter and press [INPUT] key on the "Machining cond" screen.
- (2) Press the [Y] or [INPUT] key.

**Canceling the machining condition parameter set and switch to standard parameter (Switch by menu [Std prmselect])**

- (1) Select the menu [Std prmselect] in the "Machining cond" screen.
- (2) Press the [Y] or [INPUT] key.



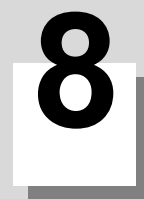

---

## Setting Machine Movable Area

This chapter describes the contents which can be set with the user parameters.

## 8.1 Setting the Stored Stroke Limit

The tool entry prohibited ranges can be set with stored stroke limit II or IIB.

Set the parameters to select the entry prohibited range, stored stroke limit II or IIB.

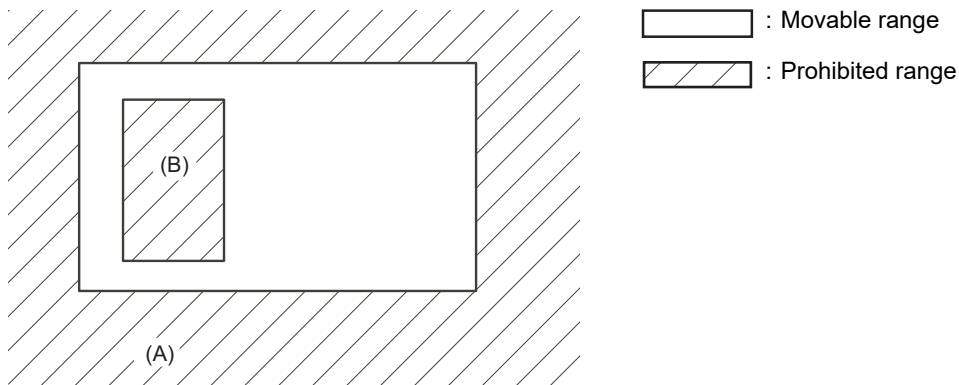

(A): Entry prohibited range by stored stroke limit II (outside)

(B): Entry prohibited range by stored stroke limit IIB (inside)

If the axis is moving over the set range, an alarm will appear and the axis will decelerate to a stop.

If the prohibited range is entered and an alarm occurs, movement will be possible only in the direction opposite the entry direction.

### Enabling conditions of stored stroke limit

When using the relative position detection system, the stored stroke limit is invalid until the reference position return is completed after the power is turned ON.

### Note

- (1) If the absolute position detection is valid when using the absolute position detection system, the stored stroke limit will be validated immediately after the power is turned ON.

### Stored stroke limit coordinates

The stored stroke limit check is carried out in the basic machine coordinate system established by the reference position return.

When the stored stroke limit has been validated while the reference position return has not been completed, the stored stroke limit check is executed with the basic machine coordinate system at the time of last power-OFF as temporary one. When the 1st dog-type reference position return is completed after the power is turned ON, the proper coordinate system is established.

### Note

- (1) While the reference position return has not been completed, only the manual and handle feed mode allow the axis movement. Automatic operation is validated after the reference position return is completed.

**CAUTION**

Always set the stored stroke limit. Failure to set this could result in collision with the machine end.

The stored stroke limit sets a prohibited range with the parameters or program command. The minimum and maximum values of the prohibited range are set as the coordinate value (radius value) on the machine coordinate system for each axis.

- The stroke check will not be executed when both maximum and minimum value are set to the same value.
- This function is valid after the reference position return if the system does not apply the absolute position detection system.
- Before the machine enters the prohibited range, an error "M01 Operation error 0007" (S/W stroke end) will occur, and the machine movement will stop. The alarm can be reset by moving the erroneous axis in the opposite direction.
- During automatic operation, if an alarm occurs with even one axis, all axes will decelerate to a stop.
- During manual operation, only the axis that caused the alarm will decelerate to a stop.
- The axis will always stop at a position before the prohibited range.
- The distance between the prohibited range and stop position will depend on the feedrate, etc.

The stored stroke limits II and IIB are handled as follows.

| Type | Prohibited range | Details                               |                          | Range setting parameters                 | Enabling conditions                                                                                                        |
|------|------------------|---------------------------------------|--------------------------|------------------------------------------|----------------------------------------------------------------------------------------------------------------------------|
| II   | Outside          | Select II or IIB with the parameters. | ♦"#8210 OT INSIDE" = "0" | "#8204 OT-CHECK-N"<br>"#8205 OT-CHECK-P" | ♦Reference position return is completed.<br>♦#8204 and #8205 are not set to the same value.<br>♦"#8202 OT-CHECK OFF" = "0" |
| IIB  | Inside           |                                       | ♦"#8210 OT INSIDE" = "1" |                                          |                                                                                                                            |

8.1.1 Stored Stroke Limit II

The boundary is set with the axis parameters "#8204 OT-CHECK-N" and "#8205 OT-CHECK-P" or with program commands. Either the inside or the outside of the set boundary is the prohibited range. Whether the inside or outside of the range is prohibited is determined by "#8210 OT-INSIDE". When the inside is selected, this function is called stored stroke limit IIB.

When using program commands, entry of the tool into the prohibited range is prohibited with G22, and entry into the prohibited range is enabled with G23.

The stored stroke limit II can be invalidated for each axis with setting "#8202 OT-CHECK OFF" to "1".

**Prohibited range**

X: Outside Z: Outside

X: Inside Z: Outside

X: Inside Z: Inside

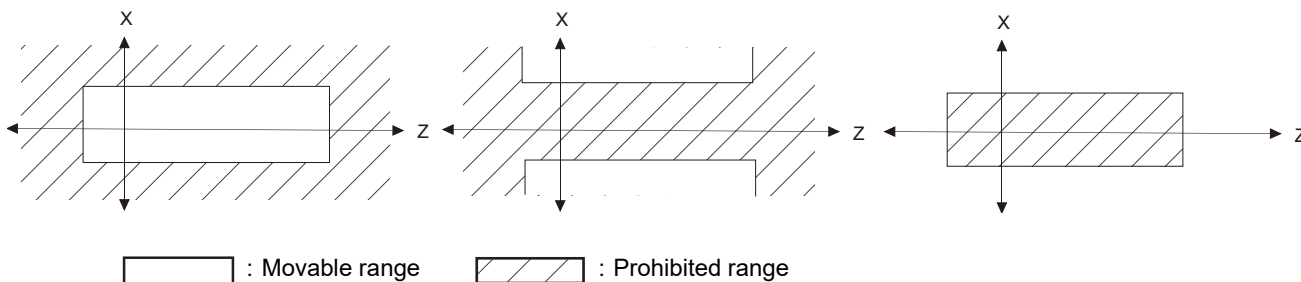



**(1) Stored stroke limit II (When prohibited range is on outside)**

When used with the stored stroke limit I function, the narrow range designated by the two types becomes the movement valid range.

The stored stroke limit I function is set by MTB.

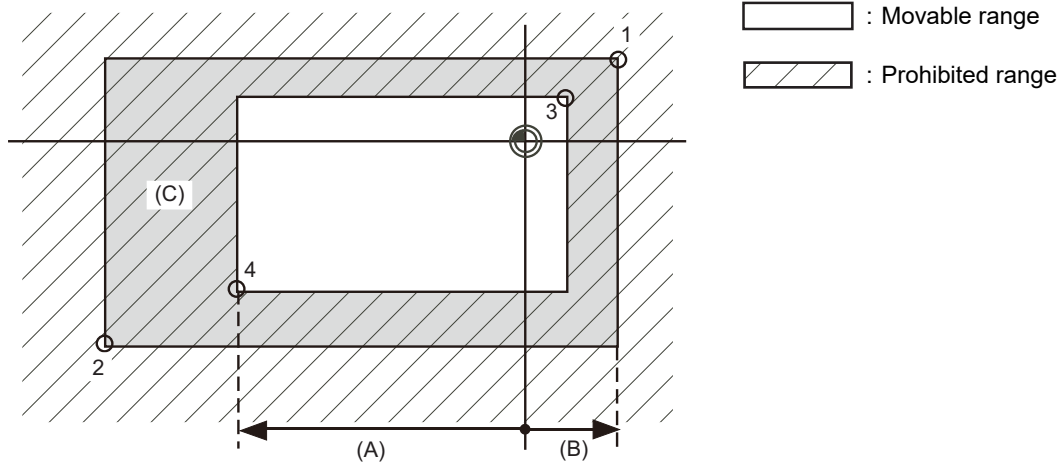

(A): Set value for (-) side

(B): Set value for (+) side

(C): The following ranges prohibited by stored stroke limit II are set with the coordinate values in the basic machine coordinate system.

Point 3: "#8205 OT-CHECK-P"

Point 4: "#8204 OT-CHECK-N"

Points 1 and 2 are the prohibited range set by MTB using the stored stroke limit I.

**(2) Stored stroke limit IIB (When prohibited range is on inside)**

A range except for that of the stored stroke limit I becomes the movement prohibited range.

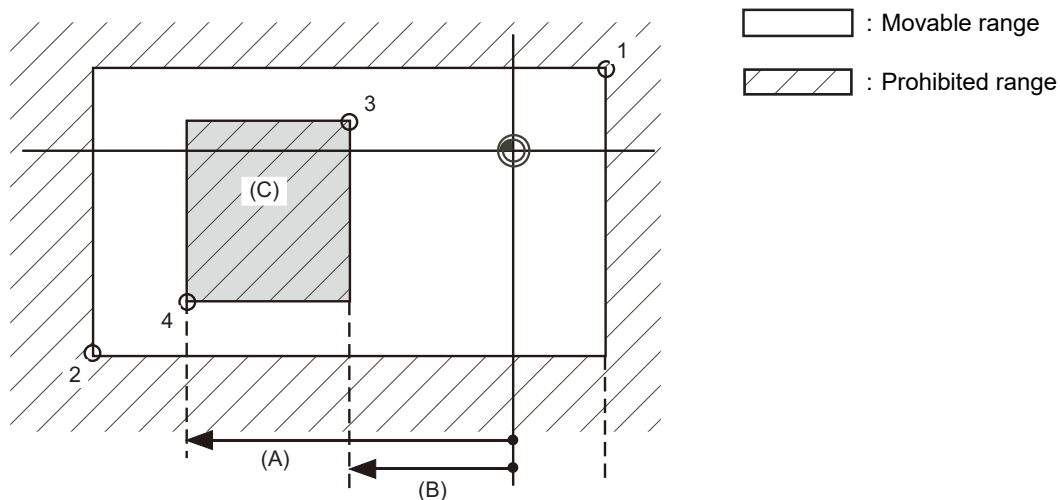

(A): Set value for (-) side

(B): Set value for (+) side

(C): The following ranges prohibited by stored stroke limit IIB are set with the coordinate values in the basic machine coordinate system.

Point 3: "#8205 OT-CHECK-P"

Point 4: "#8204 OT-CHECK-N"

Points 1 and 2 are the prohibited range set by MTB using the stored stroke limit I.

## 8.2 Chuck Barrier/Tailstock Barrier (L System)



Use this function to set and display the chuck barrier and tailstock barrier.

By limiting the tool nose movement range, the chuck barrier and tailstock barrier prevent the tool from colliding with the chuck and tailstock due to programming errors.

Three points can be input for both the chuck barrier and tailstock barrier. Select either [Enter length] or [Enter coordin] to input (set) the barrier data.

- (1) Enter length: To set the barrier position of the chuck or tailstock with the length (length between P points).
- (2) Enter coordin: To set the barrier positions of the chuck and tailstock with the distance from the workpiece center coordinates (P0). Input the radius value to set the X axis.

- (1) Enter length

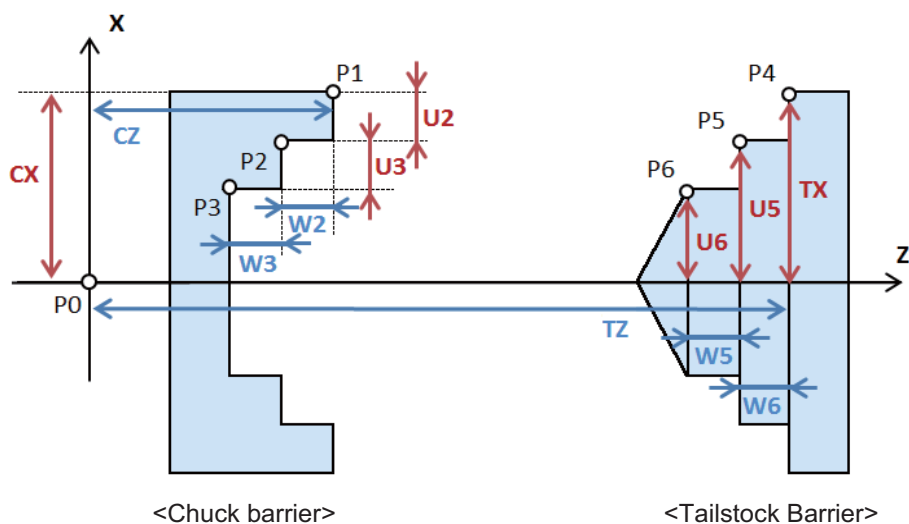

- (2) Enter coordin

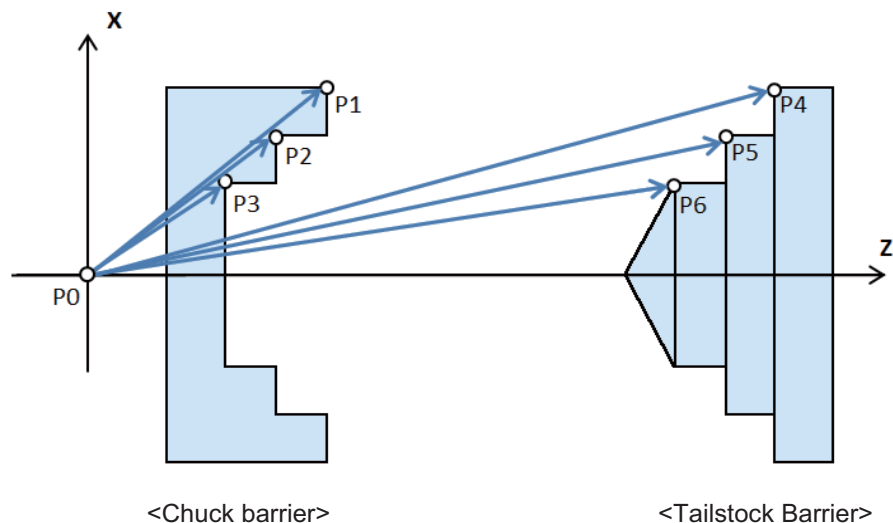

The barrier data which is set on this screen will be set to NC by converting to the parameter "#8301 P1" to "#8306 P6". Specify the workpiece center coordinates (P0) of X axis for the chuck and tailstock in advance with the parameter "#8300 P0" on the menu [Barrier data] of parameter screen. The workpiece center coordinates (P0) of Z axis are the machine coordinates zero point.

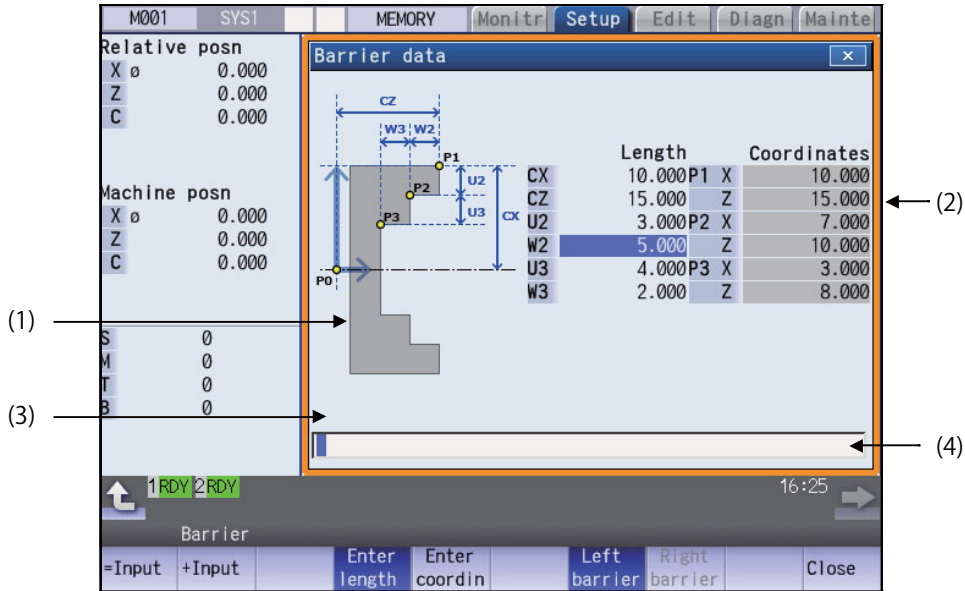

Display items

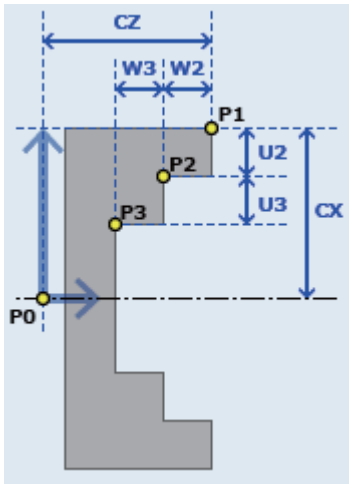
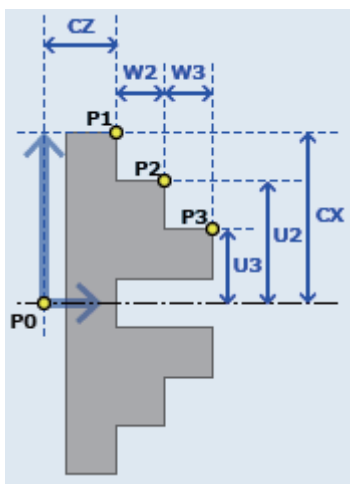
| Display items     | Details                                                                                                                                                                                                                                                                                                                                                                                                                               |
|-------------------|---------------------------------------------------------------------------------------------------------------------------------------------------------------------------------------------------------------------------------------------------------------------------------------------------------------------------------------------------------------------------------------------------------------------------------------|
| (1) Guide graphic | <p>This displays the guide drawing of barrier type. The guide drawing is switched according to the selected barrier form.</p> <p>The drawing is the left-side barrier guide drawing.</p> <p>Chuck type 1 guide drawing</p>  <p>Chuck type 2 guide drawing</p>  |

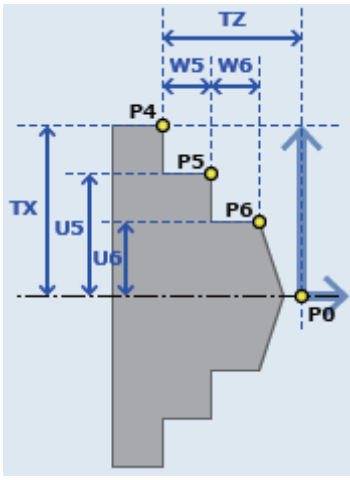
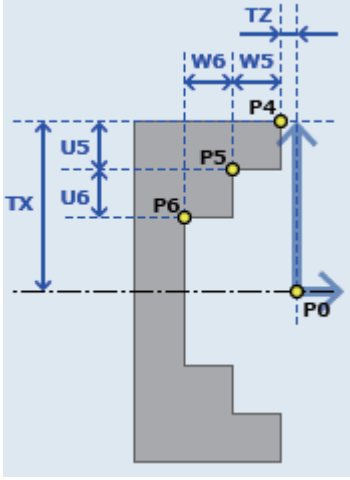
| Display items                 | Details                                                                                                                                                                                                                                                                                                                                                                                                                                                                                                                                                                                                                                                                                                                                                                                                                                                                                                                                                                                                                                                                                                                                                                                                                                                                                                                                                                                                                                                                                                                                                                                                                                                                                                                                                                                                                                                                                                                                                                                                                                                                                                                                                                                                                                                                                                                                                                                                                                                                                                                                                                                                                                                                                                           |                                                                                                                           |               |                   |        |             |                   |  |  |  |  |        |             |  |  |        |             |  |    |        |      |        |    |       |      |       |    |        |   |        |    |       |   |       |    |       |      |       |    |       |      |       |    |       |   |        |    |       |   |       |    |       |      |       |    |       |      |       |    |       |   |       |    |       |   |       |               |  |  |  |                   |  |  |  |  |        |             |  |  |        |             |  |    |        |      |        |    |       |      |       |    |        |   |        |    |       |   |       |    |       |      |       |    |       |      |       |    |       |   |        |    |       |   |       |    |       |      |       |    |       |      |       |    |       |   |       |    |       |   |       |
|-------------------------------|-------------------------------------------------------------------------------------------------------------------------------------------------------------------------------------------------------------------------------------------------------------------------------------------------------------------------------------------------------------------------------------------------------------------------------------------------------------------------------------------------------------------------------------------------------------------------------------------------------------------------------------------------------------------------------------------------------------------------------------------------------------------------------------------------------------------------------------------------------------------------------------------------------------------------------------------------------------------------------------------------------------------------------------------------------------------------------------------------------------------------------------------------------------------------------------------------------------------------------------------------------------------------------------------------------------------------------------------------------------------------------------------------------------------------------------------------------------------------------------------------------------------------------------------------------------------------------------------------------------------------------------------------------------------------------------------------------------------------------------------------------------------------------------------------------------------------------------------------------------------------------------------------------------------------------------------------------------------------------------------------------------------------------------------------------------------------------------------------------------------------------------------------------------------------------------------------------------------------------------------------------------------------------------------------------------------------------------------------------------------------------------------------------------------------------------------------------------------------------------------------------------------------------------------------------------------------------------------------------------------------------------------------------------------------------------------------------------------|---------------------------------------------------------------------------------------------------------------------------|---------------|-------------------|--------|-------------|-------------------|--|--|--|--|--------|-------------|--|--|--------|-------------|--|----|--------|------|--------|----|-------|------|-------|----|--------|---|--------|----|-------|---|-------|----|-------|------|-------|----|-------|------|-------|----|-------|---|--------|----|-------|---|-------|----|-------|------|-------|----|-------|------|-------|----|-------|---|-------|----|-------|---|-------|---------------|--|--|--|-------------------|--|--|--|--|--------|-------------|--|--|--------|-------------|--|----|--------|------|--------|----|-------|------|-------|----|--------|---|--------|----|-------|---|-------|----|-------|------|-------|----|-------|------|-------|----|-------|---|--------|----|-------|---|-------|----|-------|------|-------|----|-------|------|-------|----|-------|---|-------|----|-------|---|-------|
| (1) Guide drawing (continued) | <p>Tailstock type 1 guide drawing</p>                                                                                                                                                                                                                                                                                                                                                                                                                                                                                                                                                                                                                                                                                                                                                                                                                                                                                                                                                                                                                                                                                                                                                                                                                                                                                                                                                                                                                                                                                                                                                                                                                                                                                                                                                                                                                                                                                                                                                                                                                                                                                                                                                                                                                                                                                                                                                                                                                                                                                                                                                                                            | <p>Tailstock type 2 guide drawing</p>  |               |                   |        |             |                   |  |  |  |  |        |             |  |  |        |             |  |    |        |      |        |    |       |      |       |    |        |   |        |    |       |   |       |    |       |      |       |    |       |      |       |    |       |   |        |    |       |   |       |    |       |      |       |    |       |      |       |    |       |   |       |    |       |   |       |               |  |  |  |                   |  |  |  |  |        |             |  |  |        |             |  |    |        |      |        |    |       |      |       |    |        |   |        |    |       |   |       |    |       |      |       |    |       |      |       |    |       |   |        |    |       |   |       |    |       |      |       |    |       |      |       |    |       |   |       |    |       |   |       |
| (2) Barrier data              | <p>This displays the barrier data. The display items differ depending on the length/coordinates value input and left/right-side barrier. The setting range is from -99999.999 to 99999.999 (mm). However, minus data cannot be input for length data.</p> <p>&lt;Length input mode&gt;<br/>Set the chuck or tailstock position with the length (length between P points). When the value is set, the coordinates data is also updated.</p> <table border="0" data-bbox="523 965 1401 1189"> <tr> <td colspan="4">Chuck barrier</td> <td colspan="4">Tailstock barrier</td> </tr> <tr> <td></td> <td>Length</td> <td>Coordinates</td> <td></td> <td></td> <td>Length</td> <td>Coordinates</td> <td></td> </tr> <tr> <td>CX</td> <td>10.000</td> <td>P1 X</td> <td>10.000</td> <td>TX</td> <td>0.000</td> <td>P4 X</td> <td>0.000</td> </tr> <tr> <td>CZ</td> <td>15.000</td> <td>Z</td> <td>15.000</td> <td>TZ</td> <td>0.000</td> <td>Z</td> <td>0.000</td> </tr> <tr> <td>U2</td> <td>3.000</td> <td>P2 X</td> <td>7.000</td> <td>U5</td> <td>0.000</td> <td>P5 X</td> <td>0.000</td> </tr> <tr> <td>W2</td> <td>5.000</td> <td>Z</td> <td>10.000</td> <td>W5</td> <td>0.000</td> <td>Z</td> <td>0.000</td> </tr> <tr> <td>U3</td> <td>4.000</td> <td>P3 X</td> <td>3.000</td> <td>U6</td> <td>0.000</td> <td>P6 X</td> <td>0.000</td> </tr> <tr> <td>W3</td> <td>2.000</td> <td>Z</td> <td>8.000</td> <td>W6</td> <td>0.000</td> <td>Z</td> <td>0.000</td> </tr> </table> <p>&lt;Coordinates input mode&gt;<br/>Set the chuck or tailstock position with the distance from the workpiece center coordinates (P0). When the value is set, the length data is also updated.</p> <table border="0" data-bbox="523 1346 1401 1570"> <tr> <td colspan="4">Chuck barrier</td> <td colspan="4">Tailstock barrier</td> </tr> <tr> <td></td> <td>Length</td> <td>Coordinates</td> <td></td> <td></td> <td>Length</td> <td>Coordinates</td> <td></td> </tr> <tr> <td>CX</td> <td>10.000</td> <td>P1 X</td> <td>10.000</td> <td>TX</td> <td>0.000</td> <td>P4 X</td> <td>0.000</td> </tr> <tr> <td>CZ</td> <td>15.000</td> <td>Z</td> <td>15.000</td> <td>TZ</td> <td>0.000</td> <td>Z</td> <td>0.000</td> </tr> <tr> <td>U2</td> <td>3.000</td> <td>P2 X</td> <td>7.000</td> <td>U5</td> <td>0.000</td> <td>P5 X</td> <td>0.000</td> </tr> <tr> <td>W2</td> <td>5.000</td> <td>Z</td> <td>10.000</td> <td>W5</td> <td>0.000</td> <td>Z</td> <td>0.000</td> </tr> <tr> <td>U3</td> <td>4.000</td> <td>P3 X</td> <td>3.000</td> <td>U6</td> <td>0.000</td> <td>P6 X</td> <td>0.000</td> </tr> <tr> <td>W3</td> <td>2.000</td> <td>Z</td> <td>8.000</td> <td>W6</td> <td>0.000</td> <td>Z</td> <td>0.000</td> </tr> </table> |                                                                                                                           | Chuck barrier |                   |        |             | Tailstock barrier |  |  |  |  | Length | Coordinates |  |  | Length | Coordinates |  | CX | 10.000 | P1 X | 10.000 | TX | 0.000 | P4 X | 0.000 | CZ | 15.000 | Z | 15.000 | TZ | 0.000 | Z | 0.000 | U2 | 3.000 | P2 X | 7.000 | U5 | 0.000 | P5 X | 0.000 | W2 | 5.000 | Z | 10.000 | W5 | 0.000 | Z | 0.000 | U3 | 4.000 | P3 X | 3.000 | U6 | 0.000 | P6 X | 0.000 | W3 | 2.000 | Z | 8.000 | W6 | 0.000 | Z | 0.000 | Chuck barrier |  |  |  | Tailstock barrier |  |  |  |  | Length | Coordinates |  |  | Length | Coordinates |  | CX | 10.000 | P1 X | 10.000 | TX | 0.000 | P4 X | 0.000 | CZ | 15.000 | Z | 15.000 | TZ | 0.000 | Z | 0.000 | U2 | 3.000 | P2 X | 7.000 | U5 | 0.000 | P5 X | 0.000 | W2 | 5.000 | Z | 10.000 | W5 | 0.000 | Z | 0.000 | U3 | 4.000 | P3 X | 3.000 | U6 | 0.000 | P6 X | 0.000 | W3 | 2.000 | Z | 8.000 | W6 | 0.000 | Z | 0.000 |
| Chuck barrier                 |                                                                                                                                                                                                                                                                                                                                                                                                                                                                                                                                                                                                                                                                                                                                                                                                                                                                                                                                                                                                                                                                                                                                                                                                                                                                                                                                                                                                                                                                                                                                                                                                                                                                                                                                                                                                                                                                                                                                                                                                                                                                                                                                                                                                                                                                                                                                                                                                                                                                                                                                                                                                                                                                                                                   |                                                                                                                           |               | Tailstock barrier |        |             |                   |  |  |  |  |        |             |  |  |        |             |  |    |        |      |        |    |       |      |       |    |        |   |        |    |       |   |       |    |       |      |       |    |       |      |       |    |       |   |        |    |       |   |       |    |       |      |       |    |       |      |       |    |       |   |       |    |       |   |       |               |  |  |  |                   |  |  |  |  |        |             |  |  |        |             |  |    |        |      |        |    |       |      |       |    |        |   |        |    |       |   |       |    |       |      |       |    |       |      |       |    |       |   |        |    |       |   |       |    |       |      |       |    |       |      |       |    |       |   |       |    |       |   |       |
|                               | Length                                                                                                                                                                                                                                                                                                                                                                                                                                                                                                                                                                                                                                                                                                                                                                                                                                                                                                                                                                                                                                                                                                                                                                                                                                                                                                                                                                                                                                                                                                                                                                                                                                                                                                                                                                                                                                                                                                                                                                                                                                                                                                                                                                                                                                                                                                                                                                                                                                                                                                                                                                                                                                                                                                            | Coordinates                                                                                                               |               |                   | Length | Coordinates |                   |  |  |  |  |        |             |  |  |        |             |  |    |        |      |        |    |       |      |       |    |        |   |        |    |       |   |       |    |       |      |       |    |       |      |       |    |       |   |        |    |       |   |       |    |       |      |       |    |       |      |       |    |       |   |       |    |       |   |       |               |  |  |  |                   |  |  |  |  |        |             |  |  |        |             |  |    |        |      |        |    |       |      |       |    |        |   |        |    |       |   |       |    |       |      |       |    |       |      |       |    |       |   |        |    |       |   |       |    |       |      |       |    |       |      |       |    |       |   |       |    |       |   |       |
| CX                            | 10.000                                                                                                                                                                                                                                                                                                                                                                                                                                                                                                                                                                                                                                                                                                                                                                                                                                                                                                                                                                                                                                                                                                                                                                                                                                                                                                                                                                                                                                                                                                                                                                                                                                                                                                                                                                                                                                                                                                                                                                                                                                                                                                                                                                                                                                                                                                                                                                                                                                                                                                                                                                                                                                                                                                            | P1 X                                                                                                                      | 10.000        | TX                | 0.000  | P4 X        | 0.000             |  |  |  |  |        |             |  |  |        |             |  |    |        |      |        |    |       |      |       |    |        |   |        |    |       |   |       |    |       |      |       |    |       |      |       |    |       |   |        |    |       |   |       |    |       |      |       |    |       |      |       |    |       |   |       |    |       |   |       |               |  |  |  |                   |  |  |  |  |        |             |  |  |        |             |  |    |        |      |        |    |       |      |       |    |        |   |        |    |       |   |       |    |       |      |       |    |       |      |       |    |       |   |        |    |       |   |       |    |       |      |       |    |       |      |       |    |       |   |       |    |       |   |       |
| CZ                            | 15.000                                                                                                                                                                                                                                                                                                                                                                                                                                                                                                                                                                                                                                                                                                                                                                                                                                                                                                                                                                                                                                                                                                                                                                                                                                                                                                                                                                                                                                                                                                                                                                                                                                                                                                                                                                                                                                                                                                                                                                                                                                                                                                                                                                                                                                                                                                                                                                                                                                                                                                                                                                                                                                                                                                            | Z                                                                                                                         | 15.000        | TZ                | 0.000  | Z           | 0.000             |  |  |  |  |        |             |  |  |        |             |  |    |        |      |        |    |       |      |       |    |        |   |        |    |       |   |       |    |       |      |       |    |       |      |       |    |       |   |        |    |       |   |       |    |       |      |       |    |       |      |       |    |       |   |       |    |       |   |       |               |  |  |  |                   |  |  |  |  |        |             |  |  |        |             |  |    |        |      |        |    |       |      |       |    |        |   |        |    |       |   |       |    |       |      |       |    |       |      |       |    |       |   |        |    |       |   |       |    |       |      |       |    |       |      |       |    |       |   |       |    |       |   |       |
| U2                            | 3.000                                                                                                                                                                                                                                                                                                                                                                                                                                                                                                                                                                                                                                                                                                                                                                                                                                                                                                                                                                                                                                                                                                                                                                                                                                                                                                                                                                                                                                                                                                                                                                                                                                                                                                                                                                                                                                                                                                                                                                                                                                                                                                                                                                                                                                                                                                                                                                                                                                                                                                                                                                                                                                                                                                             | P2 X                                                                                                                      | 7.000         | U5                | 0.000  | P5 X        | 0.000             |  |  |  |  |        |             |  |  |        |             |  |    |        |      |        |    |       |      |       |    |        |   |        |    |       |   |       |    |       |      |       |    |       |      |       |    |       |   |        |    |       |   |       |    |       |      |       |    |       |      |       |    |       |   |       |    |       |   |       |               |  |  |  |                   |  |  |  |  |        |             |  |  |        |             |  |    |        |      |        |    |       |      |       |    |        |   |        |    |       |   |       |    |       |      |       |    |       |      |       |    |       |   |        |    |       |   |       |    |       |      |       |    |       |      |       |    |       |   |       |    |       |   |       |
| W2                            | 5.000                                                                                                                                                                                                                                                                                                                                                                                                                                                                                                                                                                                                                                                                                                                                                                                                                                                                                                                                                                                                                                                                                                                                                                                                                                                                                                                                                                                                                                                                                                                                                                                                                                                                                                                                                                                                                                                                                                                                                                                                                                                                                                                                                                                                                                                                                                                                                                                                                                                                                                                                                                                                                                                                                                             | Z                                                                                                                         | 10.000        | W5                | 0.000  | Z           | 0.000             |  |  |  |  |        |             |  |  |        |             |  |    |        |      |        |    |       |      |       |    |        |   |        |    |       |   |       |    |       |      |       |    |       |      |       |    |       |   |        |    |       |   |       |    |       |      |       |    |       |      |       |    |       |   |       |    |       |   |       |               |  |  |  |                   |  |  |  |  |        |             |  |  |        |             |  |    |        |      |        |    |       |      |       |    |        |   |        |    |       |   |       |    |       |      |       |    |       |      |       |    |       |   |        |    |       |   |       |    |       |      |       |    |       |      |       |    |       |   |       |    |       |   |       |
| U3                            | 4.000                                                                                                                                                                                                                                                                                                                                                                                                                                                                                                                                                                                                                                                                                                                                                                                                                                                                                                                                                                                                                                                                                                                                                                                                                                                                                                                                                                                                                                                                                                                                                                                                                                                                                                                                                                                                                                                                                                                                                                                                                                                                                                                                                                                                                                                                                                                                                                                                                                                                                                                                                                                                                                                                                                             | P3 X                                                                                                                      | 3.000         | U6                | 0.000  | P6 X        | 0.000             |  |  |  |  |        |             |  |  |        |             |  |    |        |      |        |    |       |      |       |    |        |   |        |    |       |   |       |    |       |      |       |    |       |      |       |    |       |   |        |    |       |   |       |    |       |      |       |    |       |      |       |    |       |   |       |    |       |   |       |               |  |  |  |                   |  |  |  |  |        |             |  |  |        |             |  |    |        |      |        |    |       |      |       |    |        |   |        |    |       |   |       |    |       |      |       |    |       |      |       |    |       |   |        |    |       |   |       |    |       |      |       |    |       |      |       |    |       |   |       |    |       |   |       |
| W3                            | 2.000                                                                                                                                                                                                                                                                                                                                                                                                                                                                                                                                                                                                                                                                                                                                                                                                                                                                                                                                                                                                                                                                                                                                                                                                                                                                                                                                                                                                                                                                                                                                                                                                                                                                                                                                                                                                                                                                                                                                                                                                                                                                                                                                                                                                                                                                                                                                                                                                                                                                                                                                                                                                                                                                                                             | Z                                                                                                                         | 8.000         | W6                | 0.000  | Z           | 0.000             |  |  |  |  |        |             |  |  |        |             |  |    |        |      |        |    |       |      |       |    |        |   |        |    |       |   |       |    |       |      |       |    |       |      |       |    |       |   |        |    |       |   |       |    |       |      |       |    |       |      |       |    |       |   |       |    |       |   |       |               |  |  |  |                   |  |  |  |  |        |             |  |  |        |             |  |    |        |      |        |    |       |      |       |    |        |   |        |    |       |   |       |    |       |      |       |    |       |      |       |    |       |   |        |    |       |   |       |    |       |      |       |    |       |      |       |    |       |   |       |    |       |   |       |
| Chuck barrier                 |                                                                                                                                                                                                                                                                                                                                                                                                                                                                                                                                                                                                                                                                                                                                                                                                                                                                                                                                                                                                                                                                                                                                                                                                                                                                                                                                                                                                                                                                                                                                                                                                                                                                                                                                                                                                                                                                                                                                                                                                                                                                                                                                                                                                                                                                                                                                                                                                                                                                                                                                                                                                                                                                                                                   |                                                                                                                           |               | Tailstock barrier |        |             |                   |  |  |  |  |        |             |  |  |        |             |  |    |        |      |        |    |       |      |       |    |        |   |        |    |       |   |       |    |       |      |       |    |       |      |       |    |       |   |        |    |       |   |       |    |       |      |       |    |       |      |       |    |       |   |       |    |       |   |       |               |  |  |  |                   |  |  |  |  |        |             |  |  |        |             |  |    |        |      |        |    |       |      |       |    |        |   |        |    |       |   |       |    |       |      |       |    |       |      |       |    |       |   |        |    |       |   |       |    |       |      |       |    |       |      |       |    |       |   |       |    |       |   |       |
|                               | Length                                                                                                                                                                                                                                                                                                                                                                                                                                                                                                                                                                                                                                                                                                                                                                                                                                                                                                                                                                                                                                                                                                                                                                                                                                                                                                                                                                                                                                                                                                                                                                                                                                                                                                                                                                                                                                                                                                                                                                                                                                                                                                                                                                                                                                                                                                                                                                                                                                                                                                                                                                                                                                                                                                            | Coordinates                                                                                                               |               |                   | Length | Coordinates |                   |  |  |  |  |        |             |  |  |        |             |  |    |        |      |        |    |       |      |       |    |        |   |        |    |       |   |       |    |       |      |       |    |       |      |       |    |       |   |        |    |       |   |       |    |       |      |       |    |       |      |       |    |       |   |       |    |       |   |       |               |  |  |  |                   |  |  |  |  |        |             |  |  |        |             |  |    |        |      |        |    |       |      |       |    |        |   |        |    |       |   |       |    |       |      |       |    |       |      |       |    |       |   |        |    |       |   |       |    |       |      |       |    |       |      |       |    |       |   |       |    |       |   |       |
| CX                            | 10.000                                                                                                                                                                                                                                                                                                                                                                                                                                                                                                                                                                                                                                                                                                                                                                                                                                                                                                                                                                                                                                                                                                                                                                                                                                                                                                                                                                                                                                                                                                                                                                                                                                                                                                                                                                                                                                                                                                                                                                                                                                                                                                                                                                                                                                                                                                                                                                                                                                                                                                                                                                                                                                                                                                            | P1 X                                                                                                                      | 10.000        | TX                | 0.000  | P4 X        | 0.000             |  |  |  |  |        |             |  |  |        |             |  |    |        |      |        |    |       |      |       |    |        |   |        |    |       |   |       |    |       |      |       |    |       |      |       |    |       |   |        |    |       |   |       |    |       |      |       |    |       |      |       |    |       |   |       |    |       |   |       |               |  |  |  |                   |  |  |  |  |        |             |  |  |        |             |  |    |        |      |        |    |       |      |       |    |        |   |        |    |       |   |       |    |       |      |       |    |       |      |       |    |       |   |        |    |       |   |       |    |       |      |       |    |       |      |       |    |       |   |       |    |       |   |       |
| CZ                            | 15.000                                                                                                                                                                                                                                                                                                                                                                                                                                                                                                                                                                                                                                                                                                                                                                                                                                                                                                                                                                                                                                                                                                                                                                                                                                                                                                                                                                                                                                                                                                                                                                                                                                                                                                                                                                                                                                                                                                                                                                                                                                                                                                                                                                                                                                                                                                                                                                                                                                                                                                                                                                                                                                                                                                            | Z                                                                                                                         | 15.000        | TZ                | 0.000  | Z           | 0.000             |  |  |  |  |        |             |  |  |        |             |  |    |        |      |        |    |       |      |       |    |        |   |        |    |       |   |       |    |       |      |       |    |       |      |       |    |       |   |        |    |       |   |       |    |       |      |       |    |       |      |       |    |       |   |       |    |       |   |       |               |  |  |  |                   |  |  |  |  |        |             |  |  |        |             |  |    |        |      |        |    |       |      |       |    |        |   |        |    |       |   |       |    |       |      |       |    |       |      |       |    |       |   |        |    |       |   |       |    |       |      |       |    |       |      |       |    |       |   |       |    |       |   |       |
| U2                            | 3.000                                                                                                                                                                                                                                                                                                                                                                                                                                                                                                                                                                                                                                                                                                                                                                                                                                                                                                                                                                                                                                                                                                                                                                                                                                                                                                                                                                                                                                                                                                                                                                                                                                                                                                                                                                                                                                                                                                                                                                                                                                                                                                                                                                                                                                                                                                                                                                                                                                                                                                                                                                                                                                                                                                             | P2 X                                                                                                                      | 7.000         | U5                | 0.000  | P5 X        | 0.000             |  |  |  |  |        |             |  |  |        |             |  |    |        |      |        |    |       |      |       |    |        |   |        |    |       |   |       |    |       |      |       |    |       |      |       |    |       |   |        |    |       |   |       |    |       |      |       |    |       |      |       |    |       |   |       |    |       |   |       |               |  |  |  |                   |  |  |  |  |        |             |  |  |        |             |  |    |        |      |        |    |       |      |       |    |        |   |        |    |       |   |       |    |       |      |       |    |       |      |       |    |       |   |        |    |       |   |       |    |       |      |       |    |       |      |       |    |       |   |       |    |       |   |       |
| W2                            | 5.000                                                                                                                                                                                                                                                                                                                                                                                                                                                                                                                                                                                                                                                                                                                                                                                                                                                                                                                                                                                                                                                                                                                                                                                                                                                                                                                                                                                                                                                                                                                                                                                                                                                                                                                                                                                                                                                                                                                                                                                                                                                                                                                                                                                                                                                                                                                                                                                                                                                                                                                                                                                                                                                                                                             | Z                                                                                                                         | 10.000        | W5                | 0.000  | Z           | 0.000             |  |  |  |  |        |             |  |  |        |             |  |    |        |      |        |    |       |      |       |    |        |   |        |    |       |   |       |    |       |      |       |    |       |      |       |    |       |   |        |    |       |   |       |    |       |      |       |    |       |      |       |    |       |   |       |    |       |   |       |               |  |  |  |                   |  |  |  |  |        |             |  |  |        |             |  |    |        |      |        |    |       |      |       |    |        |   |        |    |       |   |       |    |       |      |       |    |       |      |       |    |       |   |        |    |       |   |       |    |       |      |       |    |       |      |       |    |       |   |       |    |       |   |       |
| U3                            | 4.000                                                                                                                                                                                                                                                                                                                                                                                                                                                                                                                                                                                                                                                                                                                                                                                                                                                                                                                                                                                                                                                                                                                                                                                                                                                                                                                                                                                                                                                                                                                                                                                                                                                                                                                                                                                                                                                                                                                                                                                                                                                                                                                                                                                                                                                                                                                                                                                                                                                                                                                                                                                                                                                                                                             | P3 X                                                                                                                      | 3.000         | U6                | 0.000  | P6 X        | 0.000             |  |  |  |  |        |             |  |  |        |             |  |    |        |      |        |    |       |      |       |    |        |   |        |    |       |   |       |    |       |      |       |    |       |      |       |    |       |   |        |    |       |   |       |    |       |      |       |    |       |      |       |    |       |   |       |    |       |   |       |               |  |  |  |                   |  |  |  |  |        |             |  |  |        |             |  |    |        |      |        |    |       |      |       |    |        |   |        |    |       |   |       |    |       |      |       |    |       |      |       |    |       |   |        |    |       |   |       |    |       |      |       |    |       |      |       |    |       |   |       |    |       |   |       |
| W3                            | 2.000                                                                                                                                                                                                                                                                                                                                                                                                                                                                                                                                                                                                                                                                                                                                                                                                                                                                                                                                                                                                                                                                                                                                                                                                                                                                                                                                                                                                                                                                                                                                                                                                                                                                                                                                                                                                                                                                                                                                                                                                                                                                                                                                                                                                                                                                                                                                                                                                                                                                                                                                                                                                                                                                                                             | Z                                                                                                                         | 8.000         | W6                | 0.000  | Z           | 0.000             |  |  |  |  |        |             |  |  |        |             |  |    |        |      |        |    |       |      |       |    |        |   |        |    |       |   |       |    |       |      |       |    |       |      |       |    |       |   |        |    |       |   |       |    |       |      |       |    |       |      |       |    |       |   |       |    |       |   |       |               |  |  |  |                   |  |  |  |  |        |             |  |  |        |             |  |    |        |      |        |    |       |      |       |    |        |   |        |    |       |   |       |    |       |      |       |    |       |      |       |    |       |   |        |    |       |   |       |    |       |      |       |    |       |      |       |    |       |   |       |    |       |   |       |
| (3) Error message             | This is displayed when barrier data setting is illegal.                                                                                                                                                                                                                                                                                                                                                                                                                                                                                                                                                                                                                                                                                                                                                                                                                                                                                                                                                                                                                                                                                                                                                                                                                                                                                                                                                                                                                                                                                                                                                                                                                                                                                                                                                                                                                                                                                                                                                                                                                                                                                                                                                                                                                                                                                                                                                                                                                                                                                                                                                                                                                                                           |                                                                                                                           |               |                   |        |             |                   |  |  |  |  |        |             |  |  |        |             |  |    |        |      |        |    |       |      |       |    |        |   |        |    |       |   |       |    |       |      |       |    |       |      |       |    |       |   |        |    |       |   |       |    |       |      |       |    |       |      |       |    |       |   |       |    |       |   |       |               |  |  |  |                   |  |  |  |  |        |             |  |  |        |             |  |    |        |      |        |    |       |      |       |    |        |   |        |    |       |   |       |    |       |      |       |    |       |      |       |    |       |   |        |    |       |   |       |    |       |      |       |    |       |      |       |    |       |   |       |    |       |   |       |
| (4) Input section             | This displays the input data.                                                                                                                                                                                                                                                                                                                                                                                                                                                                                                                                                                                                                                                                                                                                                                                                                                                                                                                                                                                                                                                                                                                                                                                                                                                                                                                                                                                                                                                                                                                                                                                                                                                                                                                                                                                                                                                                                                                                                                                                                                                                                                                                                                                                                                                                                                                                                                                                                                                                                                                                                                                                                                                                                     |                                                                                                                           |               |                   |        |             |                   |  |  |  |  |        |             |  |  |        |             |  |    |        |      |        |    |       |      |       |    |        |   |        |    |       |   |       |    |       |      |       |    |       |      |       |    |       |   |        |    |       |   |       |    |       |      |       |    |       |      |       |    |       |   |       |    |       |   |       |               |  |  |  |                   |  |  |  |  |        |             |  |  |        |             |  |    |        |      |        |    |       |      |       |    |        |   |        |    |       |   |       |    |       |      |       |    |       |      |       |    |       |   |        |    |       |   |       |    |       |      |       |    |       |      |       |    |       |   |       |    |       |   |       |

## Menus

| Menus         | Details                                                                                                                                   |
|---------------|-------------------------------------------------------------------------------------------------------------------------------------------|
| =Input        | This executes an absolute input.                                                                                                          |
| +Input        | This executes an incremental input.                                                                                                       |
| Enter length  | This changes to the length input.                                                                                                         |
| Enter coordin | This changes to the coordinates value input.                                                                                              |
| Left barrier  | This changes to the left-side barrier data setting.<br>When the parameter "#8315 BARRIER TYPE (L)" is "0", this menu cannot be selected.  |
| Right barrier | This changes to the right-side barrier data setting.<br>When the parameter "#8316 BARRIER TYPE (R)" is "0", this menu cannot be selected. |
| Close         | This closes the pop-up window and quits this function.                                                                                    |





Menus when the menu [Left barrier] or [Right barrier] is pressed

| Menus          | Details                                                             |
|----------------|---------------------------------------------------------------------|
| Chuck type 1   | This changes the barrier form to the chuck barrier type 1. (*1)     |
| Chuck type 2   | This changes the barrier form to the chuck barrier type 2. (*1)     |
| T-stock type 1 | This changes the barrier form to the tailstock barrier type 1. (*2) |
| T-stock type 2 | This changes the barrier form to the tailstock barrier type 2. (*2) |





(\*1) This menu can be selected when the parameter "#8315 BARRIER TYPE (L)" or "#8316 BARRIER TYPE (R)" is "1".

(\*2) This menu can be selected when the parameter "#8315 BARRIER TYPE (L)" or "#8316 BARRIER TYPE (R)" is "2".

**Setting the barrier position with length (length between P points)**

- |                                                                                                                                                                                                                                                                       |                                                                                   |                                                                                                                                                                                                                                                               |
|-----------------------------------------------------------------------------------------------------------------------------------------------------------------------------------------------------------------------------------------------------------------------|-----------------------------------------------------------------------------------|---------------------------------------------------------------------------------------------------------------------------------------------------------------------------------------------------------------------------------------------------------------|
| (1) Press the menu [Enter length].                                                                                                                                                                                                                                    |  | The mode is switched to the length input mode. The highlight of the menu [Enter coordin] is canceled and the [Enter length] is highlighted.<br>The cursor is displayed at CX, and the length data can be set.                                                 |
| (2) Select whether the barrier to be set is right side or left side with the menu.<br>(Example) Press the menu [Left barrier].                                                                                                                                        |  | The display is switched to the menu of the barrier form.                                                                                                                                                                                                      |
| (3) Select the chuck type with the menu.<br>(Example) Press the menu [Chuck type 2].                                                                                                                                                                                  |  | The drawing is switched to the chuck barrier type 2 guide drawing.                                                                                                                                                                                            |
| (4) Input the value to CX.<br>20.000 [INPUT]<br>The setting can be performed also by pressing the menu [=Input] or [+Input] instead of the [INPUT] key. When the menu [+Input] is pressed, the value obtained by adding the input value to the original value is set. |  | The value "20.000" is set to the cursor position (CX), and the coordinates value is also updated.<br>The cursor moves to CZ.<br>Consistency check is performed for respective setting data, and an error message is displayed when an illegality is detected. |
| (5) Input the values to CZ to W3 in the same way.                                                                                                                                                                                                                     |                                                                                   |                                                                                                                                                                                                                                                               |

**Setting the barrier position with coordinates value (distance from the work center coordinates (barrier P0))**

- |                                                                                                                                                                                                                                                                         |                                                                                     |                                                                                                                                                                                                                                                        |
|-------------------------------------------------------------------------------------------------------------------------------------------------------------------------------------------------------------------------------------------------------------------------|-------------------------------------------------------------------------------------|--------------------------------------------------------------------------------------------------------------------------------------------------------------------------------------------------------------------------------------------------------|
| (1) Press the menu [Enter coordin].                                                                                                                                                                                                                                     |  | The mode is switched to the coordinates input mode. The highlight of the menu [Enter length] is cancelled and the menu [Enter coordin] is highlighted.<br>The cursor is displayed at P1 X, and the coordinates data can be set.                        |
| (2) Select whether the barrier to be set is right side or left side with the menu.<br>(Example) Press the menu [Right barrier].                                                                                                                                         |  | The display is switched to the menu of the barrier form.                                                                                                                                                                                               |
| (3) Select the tailstock type with the menu.<br>(Example) Press the menu [T-stock type 1].                                                                                                                                                                              |  | The drawing is switched to the tailstock barrier type 1 guide drawing.                                                                                                                                                                                 |
| (4) Input the value to P1 X.<br>30.000 [INPUT]<br>The setting can be performed also by pressing the menu [=Input] or [+Input] instead of the [INPUT] key. When the menu [+Input] is pressed, the value obtained by adding the input value to the original value is set. |  | The value "30.000" is set to the cursor position (P1 X), and the length is also updated.<br>The cursor moves to P1 Z.<br>Consistency check is performed for respective setting data, and an error message is displayed when an illegality is detected. |
| (5) Input the values to P1 Z to P3 Z in the same way.                                                                                                                                                                                                                   |                                                                                     |                                                                                                                                                                                                                                                        |

**Precautions**

- (1) When the parameter "#8310 Barrier ON" is set to "0", the chuck and tailstock barriers settings are disabled.
- (2) The parameter "#8300 P0" and "#8311 P7" to "#8314 P10" cannot be set on this screen. Set the parameters with the menu [Barrier data] on the parameter screen.
- (3) When the parameters "#8315" and "#8316" are both "0", the barrier data is handled as left barrier and chuck type 1. The chuck type cannot be changed.
- (4) When the parameter for chuck or tailstock is set to both right and left barriers, an error message appears.
- (5) When multiple errors are occurred, an error concerning the X axis is preferentially displayed.

## Other Setups



## 9.1 Pallet Program Registration



Machining programs can be registered per each pallet of the automatic pallet changer (hereinafter APC) and the indexing plane from the menu [Pallet] on the setup (Setup) screen.

The pallet program registration screens include "Standard Pallet Registration screen" and "Pallet 4 Page Registration screen", and those two screens can be switched by the parameters.

| #11001APC type | Screen                            |                       | Function                                                                                                                                                                                                     |
|----------------|-----------------------------------|-----------------------|--------------------------------------------------------------------------------------------------------------------------------------------------------------------------------------------------------------|
| 0              | Standard Pallet Registration      |                       | Registration of machining programs for pallet 1 & 2 is carried out. Pallet 1 & 2 can be registered at once.                                                                                                  |
| 1              | Pallet 4 Page Registration screen | Pallet List Screen    | Machining program device, file name, machining status, and index planes under machining for 4 planes of the pallet 1 to 12 are displayed.<br>Information of 2 pallets can be displayed at once.              |
|                |                                   | Pallet Details Screen | Machining program device, file name, machining status, and external workpiece coordinates for each plane of the pallet 1 to 12 are set.<br>Information of one pallet's 2 indexing planes can be set at once. |

### Note

(1) The number of pallets is determined by the parameter "#11002 Valid pallet num".

Manual numerical value command can be executed when manual numerical value command window is displayed by inputting an address key such as MST, etc.

For the pallet 4 page registration screen, the screen type (pallet list and pallet details) is memorized. When the screen is transferred to other screen and displayed again, the type which was displayed a moment ago is displayed. For the file selection, the pallet details is displayed.

9.1.1 Standard Pallet Registration

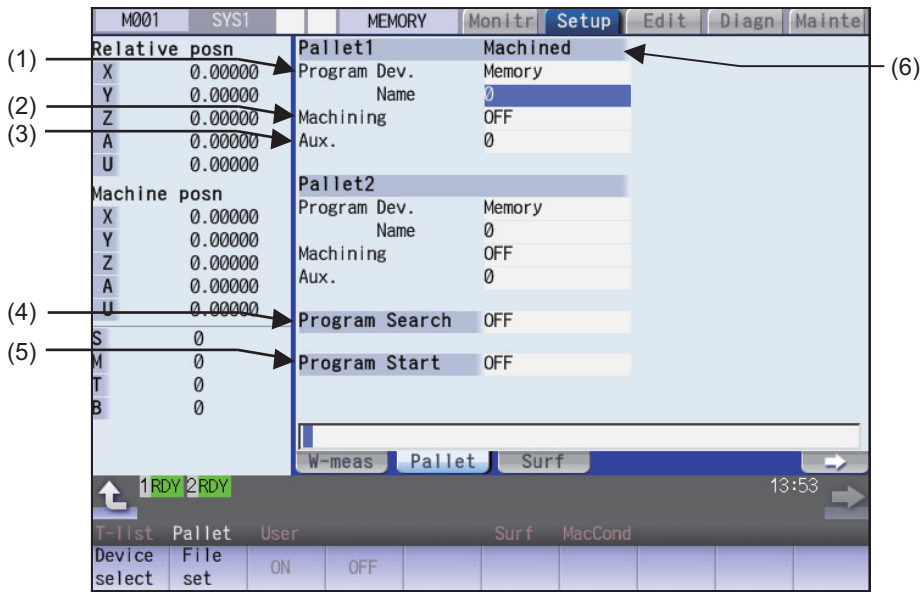

**Display items**

| Display items                 | Description                                                                                                                                                                                                                                 |
|-------------------------------|---------------------------------------------------------------------------------------------------------------------------------------------------------------------------------------------------------------------------------------------|
| (1) Pallet, Device, File name | The machining program device and file name registered for each pallet are displayed.                                                                                                                                                        |
| (2) Machining ON/OFF          | The ON/OFF state of machining for each pallet is displayed.                                                                                                                                                                                 |
| (3) Aux.                      | If auxiliary function is available, the auxiliary function data for each pallet is displayed. Refer to the manual issued by the MTB for details on the corresponding functions.                                                             |
| (4) Program Search ON/OFF     | The ON/OFF state of search for the registered machining program is displayed.                                                                                                                                                               |
| (5) Program Start ON/OFF      | The ON/OFF state of continuous start for the registered machining program is displayed. When set to ON, the searched program will be started for the pallet in the machine. This setting is valid only when pallet program search is valid. |
| (6) Machined                  | "Machined" is displayed for the pallet in the machine.                                                                                                                                                                                      |

**Menus**

| Menus         | Description                                                                                                                                                                                |
|---------------|--------------------------------------------------------------------------------------------------------------------------------------------------------------------------------------------|
| Device select | This displays the device menu. When selected, the device name of the pallet currently indicated by the cursor is changed.                                                                  |
| File set      | The file name to be registered can be selected from the list. A list of files of the currently selected device is displayed. This menu can be used only when the cursor is at file name.   |
| ON            | The state (Machining, Program Search, Program Start) indicated by the cursor is validated. This menu can be used only when the cursor is at Machining, Program Search, or Program Start.   |
| OFF           | The state (Machining, Program Search, Program Start) indicated by the cursor is invalidated. This menu can be used only when the cursor is at Machining, Program Search, or Program Start. |

**Operation method (Registering a machining program for the pallet)**

- (1) Using the [↑], [↓], [←], [→] keys, move the cursor to the area of the pallet for which a program is to be registered.
- (2) Press the menu [Device select] and select a device.  The cursor moves to "Device". The device menu (memory, HD, memory card, DS or USB memory) is displayed. If selected, the device selected in "Device" is displayed.
- (3) Move the cursor to "Program Name" and input the program No.
- (4) Move the cursor to "Machining" and press the menu [ON] or [OFF].
- (5) Move the cursor to "Program Search" and press the menu [ON] or [OFF].
- (6) Move the cursor to "Program Start" and press the menu [ON] or [OFF].

**Operation method (Selecting a file from the list)**

- (1) Move the cursor to "File name" and press the menu [File set].
- (2) Move the cursor to an arbitrary file and press the [INPUT] key.  
(An arbitrary file name can be directly entered as well.)

**Note**

- (1) When a file name is directly entered, whether or not the file exists is not checked.
- (2) When a file name is directly entered, if other than character strings or values within the setting range (1 to 99,999,999) is set, an error occurs.
- (3) If a directory is specified, a setting error occurs.
- (4) When the menu [Sort change] is pressed, the sorting method is changed. For details, refer to "10.1.3 Changing the Sorting Method".

9.1.2 Pallet List Screen

Machining program device, file name, machining status, and index planes under machining for 4 planes of the pallet 1 to 12 are displayed.

**Note**

(1) The number of pallets is determined by the parameter "#11002 Valid pallet num".

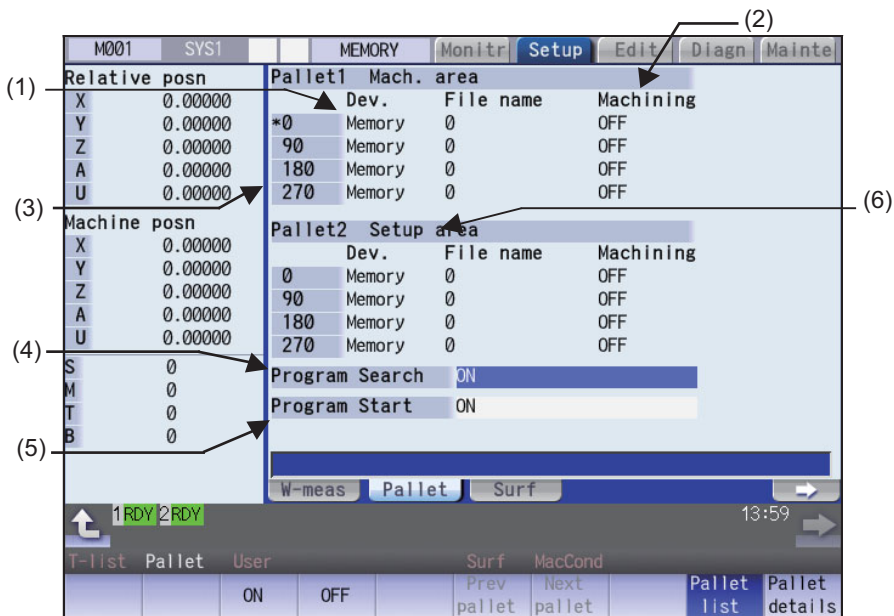

**Display items**

| Display items                         | Description                                                                                                                                                                                                                                                                                                                                                                                                                                                                                                                                                      |
|---------------------------------------|------------------------------------------------------------------------------------------------------------------------------------------------------------------------------------------------------------------------------------------------------------------------------------------------------------------------------------------------------------------------------------------------------------------------------------------------------------------------------------------------------------------------------------------------------------------|
| (1) Pallet, Device, File name         | Machining program device name and file name to be registered in each pallet's index plane are displayed.                                                                                                                                                                                                                                                                                                                                                                                                                                                         |
| (2) Machining ON/OFF                  | Whether machining for each pallet's index plane is valid or invalid is displayed.                                                                                                                                                                                                                                                                                                                                                                                                                                                                                |
| (3) Machining index plane             | 0°, 90°, 180°, 270° are displayed.<br>An asterisk (*) is displayed with the angle of the index plane.                                                                                                                                                                                                                                                                                                                                                                                                                                                            |
| (4) Program Search ON/OFF             | The ON/OFF state of search for the registered machining program is displayed.<br>When valid, the next program registered will be searched automatically as soon as the currently machining program finishes. The next program is one of the valid index plane programs after the pallet in the machine. External workpiece coordinate set in the pallet detailed screen during search is set in the external workpiece coordinate system shift (EXT). Auto restart is disabled. If auto restart is turned ON by PLC switch, it will be automatically turned OFF. |
| (5) Program Start ON/OFF              | The ON/OFF state of continuous start for the registered machining program is displayed.<br>When set to ON, the searched program will be started for the pallet in the machine. This setting is valid only when pallet program search is valid.                                                                                                                                                                                                                                                                                                                   |
| (6) Pallet information in the machine | Whether pallet is in the machine is displayed.<br>•Mach. area: When pallet is in the machine<br>•Setup area: When pallet is not in the machine                                                                                                                                                                                                                                                                                                                                                                                                                   |

**Menus**

| Menus          | Description                                                                                                                                                                                   |
|----------------|-----------------------------------------------------------------------------------------------------------------------------------------------------------------------------------------------|
| ON             | The state (Machining, Program Search, Program Start) indicated by the cursor is validated.<br>This menu can be used only when the cursor is at Machining, Program Search, or Program Start.   |
| OFF            | The state (Machining, Program Search, Program Start) indicated by the cursor is invalidated.<br>This menu can be used only when the cursor is at Machining, Program Search, or Program Start. |
| Prev pallet    | Information on the previous two pallets is displayed.                                                                                                                                         |
| Next pallet    | Information on the next two pallets is displayed.                                                                                                                                             |
| Pallet list    | A list of pallets is displayed.                                                                                                                                                               |
| Pallet details | The screen is shifted to the Pallet details screen.<br>The 0° or 90° data of the pallet displayed on the top line of the Pallet list screen is displayed.                                     |

**Operation method (Changing display pallet)**

- (1) When the pallet 1 and 2 are displayed, press the menu [Next pallet] or next page key. → Pallet 3 and 4 are displayed.
- (2) Press the menu [Prev pallet] or previous page key. → Pallet 1 and 2 are displayed.

**Operation method (Setting pallet program search)**

- (1) Using the [↑], [↓], [←], [→] keys, move the cursor to "Program Search" and press the menu [ON] or [OFF]. → The contents set in "Program Search" is displayed. The cursor moves to "Program Start".

**Operation method (Setting continuous start)**

- (1) Using the [↑], [↓], [←], [→] keys, move the cursor to "Program Start" and press the menu [ON] or [OFF]. → The contents set in "Program Start" is displayed. The cursor moves to "Program Search".

Every time the [↑], [↓], [←] or [→] key is pressed, the cursor switches between "Program Search" and "Program Start".

9.1.3 Pallet Details Screen

Machining program device, file name, machining status, Aux. and external workpiece coordinates for each plane of the pallet 1 to 12 are set.

**Note**

(1) The number of pallets is determined by the parameter "#11002 Valid pallet num".

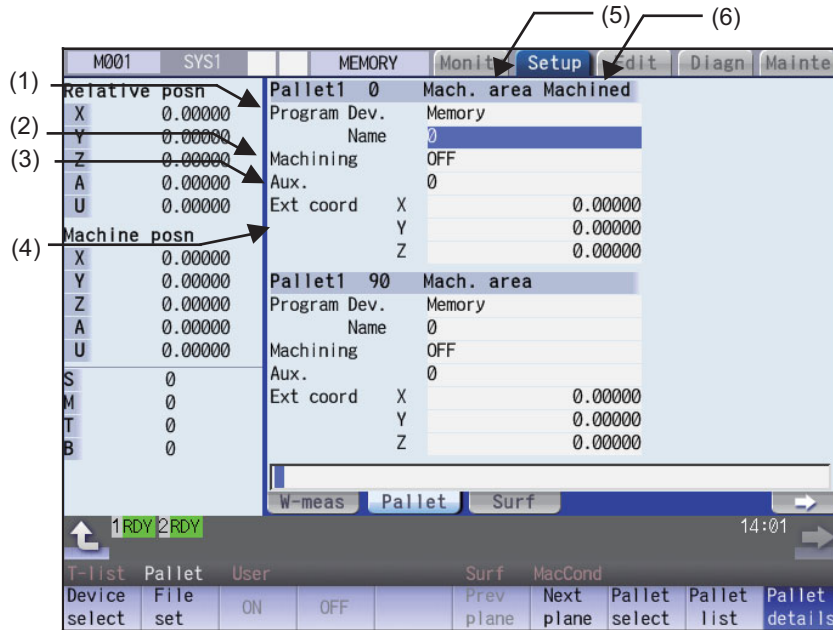

**Display items**

| Display items                         | Description                                                                                                                                                                                                                                                                                                                                                                                                                                                                                                                                                                                                                                                                                                                                                                                                                                                                                                                                                                |
|---------------------------------------|----------------------------------------------------------------------------------------------------------------------------------------------------------------------------------------------------------------------------------------------------------------------------------------------------------------------------------------------------------------------------------------------------------------------------------------------------------------------------------------------------------------------------------------------------------------------------------------------------------------------------------------------------------------------------------------------------------------------------------------------------------------------------------------------------------------------------------------------------------------------------------------------------------------------------------------------------------------------------|
| (1) Pallet, Device, File name         | Machining program device name and file name to be registered in each pallet's index plane are displayed.                                                                                                                                                                                                                                                                                                                                                                                                                                                                                                                                                                                                                                                                                                                                                                                                                                                                   |
| (2) Machining ON/OFF                  | Whether machining for each pallet's index plane is valid or invalid is displayed.                                                                                                                                                                                                                                                                                                                                                                                                                                                                                                                                                                                                                                                                                                                                                                                                                                                                                          |
| (3) Aux.                              | If auxiliary function is available, the auxiliary function data for each pallet is displayed. Refer to the manual issued by the MTB for details on the corresponding functions.                                                                                                                                                                                                                                                                                                                                                                                                                                                                                                                                                                                                                                                                                                                                                                                            |
| (4) Ext coord                         | The set data (X to Z axis) is set in the pallet No. and extended workpiece coordinate offset corresponding to the index plane.<br>The value set in the extended workpiece coordinate offset is written into the external workpiece coordinate system shift (EXT) according to the command from PLC.<br>When the extended workpiece coordinate offset for the machining surface of a pallet in machine is changed, only the changed axis data is written into the external workpiece coordinate system shift (EXT).<br>X to Z axis: External workpiece coordinate data<br>(Example) Pallet 1 0°: Extended workpiece coordinate offset 49 sets<br>Pallet 1 90°: Extended workpiece coordinate offset 50 sets<br>Pallet 1 180°: Extended workpiece coordinate offset 51 sets<br>Pallet 1 270°: Extended workpiece coordinate offset 52 sets<br>Pallet 2 0°: Extended workpiece coordinate offset 53 sets<br>:<br>Pallet 12 270°: Extended workpiece coordinate offset 96 sets |
| (5) Pallet information in the machine | Whether pallet is in the machine is displayed.<br>•Mach. area: When pallet is in the machine<br>•Setup area: When pallet is not in the machine                                                                                                                                                                                                                                                                                                                                                                                                                                                                                                                                                                                                                                                                                                                                                                                                                             |
| (6) Machined                          | "Machined" is displayed on the index plane of a pallet in the machine.                                                                                                                                                                                                                                                                                                                                                                                                                                                                                                                                                                                                                                                                                                                                                                                                                                                                                                     |

**Note**

- (1) "Pallet running" appears when the setting of "Program Dev.", "Program Name", "Machining", or "Aux." is executed to the index plane under machining of a pallet in machine. The "Program Dev.", "Program Name", "Machining", or "Aux." can be set when the index plane of a pallet in machine is not under machining.  
Even if the index plane of a pallet in machine is under machining, the external workpiece coordinate can be set.
- (2) For the pallet 4 page registration screen, do not use the extended workpiece coordinate offset because the extended workpiece coordinate offset value is reflected on the external workpiece coordinate system shift.

**Menus**

| Menus          | Description                                                                                                                                                                                                                                                                                                                                     |
|----------------|-------------------------------------------------------------------------------------------------------------------------------------------------------------------------------------------------------------------------------------------------------------------------------------------------------------------------------------------------|
| Device select  | This displays the device menu.<br>When selected, the device name of the pallet currently indicated by the cursor is changed.<br>When a device other than memory is selected, the route is displayed first.                                                                                                                                      |
| File set       | The file name to be registered can be selected from the list.<br>A list of files of the currently selected device is displayed.<br>This menu can be used only when the cursor is at file name.                                                                                                                                                  |
| ON             | The state (Machining) indicated by the cursor is validated.<br>This menu can be used only when the cursor is at Machining.                                                                                                                                                                                                                      |
| OFF            | The state (Machining) indicated by the cursor is invalidated.<br>This menu can be used only when the cursor is at Machining.                                                                                                                                                                                                                    |
| Prev plane     | Previous index plane is displayed.<br>When 0° or 90° index plane is being displayed, this menu displays the previous pallet, 180° or 270° index plane.<br>When 180° or 270° index plane is being displayed, this menu displays 0° or 90° index plane.<br>When 0° or 90° index plane of the pallet 1 is displayed, this menu cannot be selected. |
| Next plane     | Next index plane is displayed.<br>When 0° or 90° index plane is being displayed, this menu displays 180° or 270° index plane.<br>When 180° or 270° index plane is being displayed, this menu displays the next pallet, 0° or 90° index plane.<br>When 180° or 270° index plane of the last pallet is displayed, this menu cannot be selected.   |
| Pallet select  | An arbitrary pallet can be selected.<br>When the pallet No. is set and the [INPUT] key is pressed, the 0° or 90° pallet details data for that pallet is displayed.<br>The cursor will move to the 0° machining program file name.                                                                                                               |
| Pallet list    | The Pallet list screen will open.                                                                                                                                                                                                                                                                                                               |
| Pallet details | This displays the pallet details.                                                                                                                                                                                                                                                                                                               |

**Operation method (Changing display pallet)**

- (1) Press the menu [Pallet select]. Input pallet No. and press the [INPUT] key.  The pallet 5's 0° and 90° index plane will appear.  
(Example) 5 [INPUT]

**Operation method (Changing index planes)**

(Example) When the screen display status acquired after the above (Changing display pallets) operation

- (1) Press the menu [Next plane] or next page key. ➡ The pallet 5's 0° and 90° index plane will appear.
- (2) Press the [Prev plane] or previous page key. ➡ The pallet 5's 0° and 90° index plane will appear.

The display of pallet and index plane changes as follows.

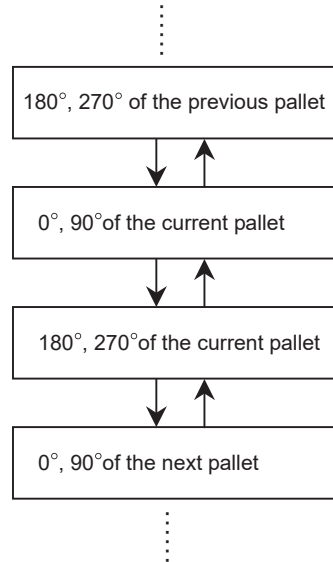
**Operation method (Setting values in each index plane)**

- (1) An arbitrary index plane is displayed using the operation method above.
- (2) Press the menu [Device select] and select a device. ➡ The cursor moves to "Device". The device menu (memory, HD, memory card, DS or USB memory) is displayed. If selected, the selected device is displayed in "Program Dev.". After setting, the cursor moves to "File name".
- (3) Move the cursor to "Program Name" and enter the program No.
- (4) Move the cursor to "Machining" and press the menu [ON] or [OFF].
- (5) Move the cursor to "Ext coord" and input values for 3 axes.



## 9.2 R-Navi



By setting machining surface coordinate system (feature coordinate system), an optional machining surface can be registered. By selecting registered machining surface on surface selection of monitor screen, commands programmed along three orthogonal axes can move the tool along the coordinate system of this machining surface (feature coordinate system). This selected surface is called a machining target surface. This enables a program with three orthogonal axes to carry out multi-surface machining including inclined surface machining.

This function is an additional specification, and the setting is common for all the part systems.

The following flow chart shows the sequence of registering a machining surface.

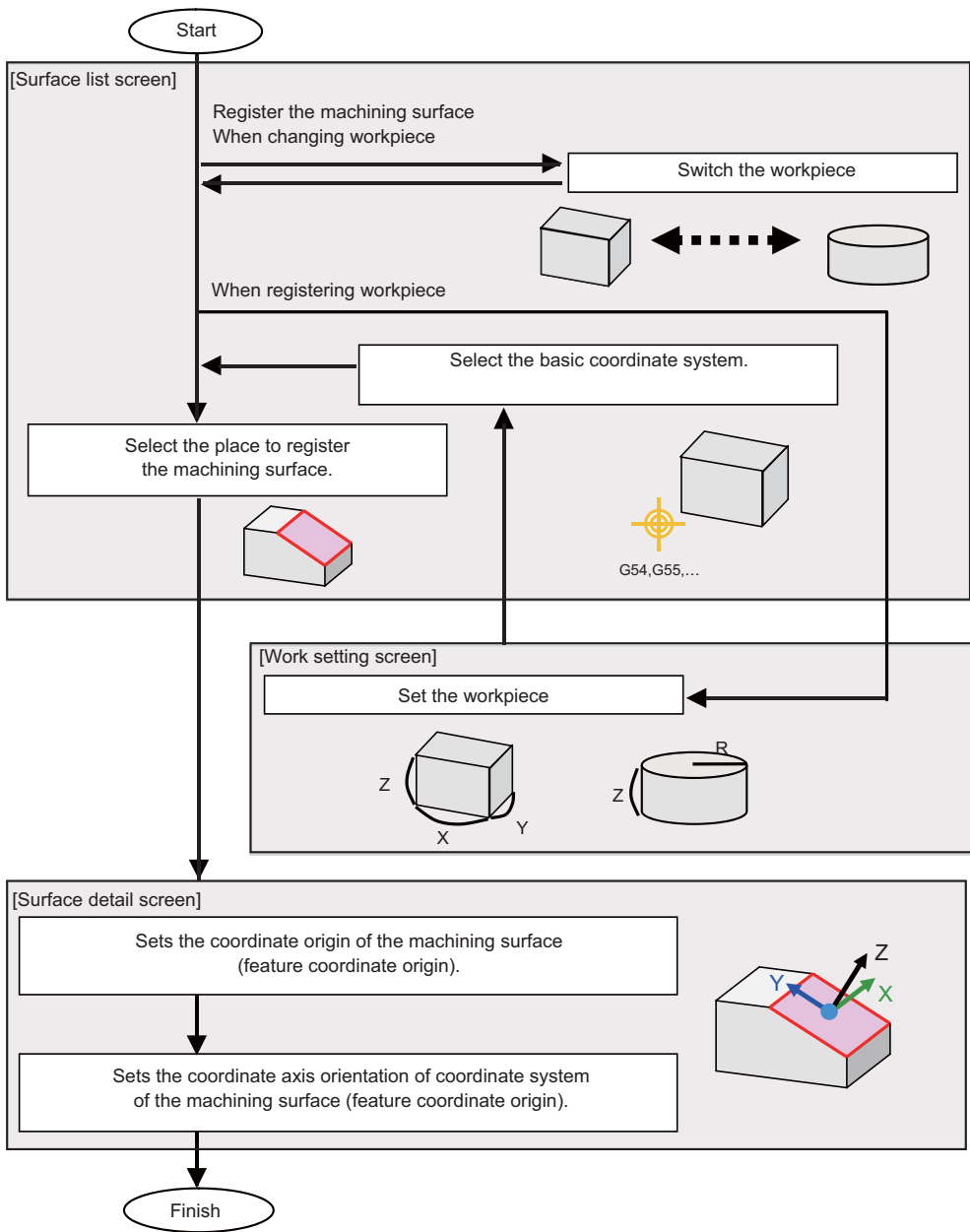

9.2.1 Selecting where to Register a Machining Surface (Machining Surface List Screen)

On the surface list screen the place to register a machining surface can be selected.

**Note**

(1) When workpiece is initially registered, the surface "BASE-SURFACE" registers. The coordinate zero and axial directions of this machining surface is the same as of the basic coordinate system. The following operations are disabled for this machining surface. The message "Setting error", "Clear not possible", or "Paste error" is displayed.

- Change the surface name
- Clear the surface
- Paste the surface
- Display the data (coordinate zero/axial direction) of the surface using the menu [Detail set]

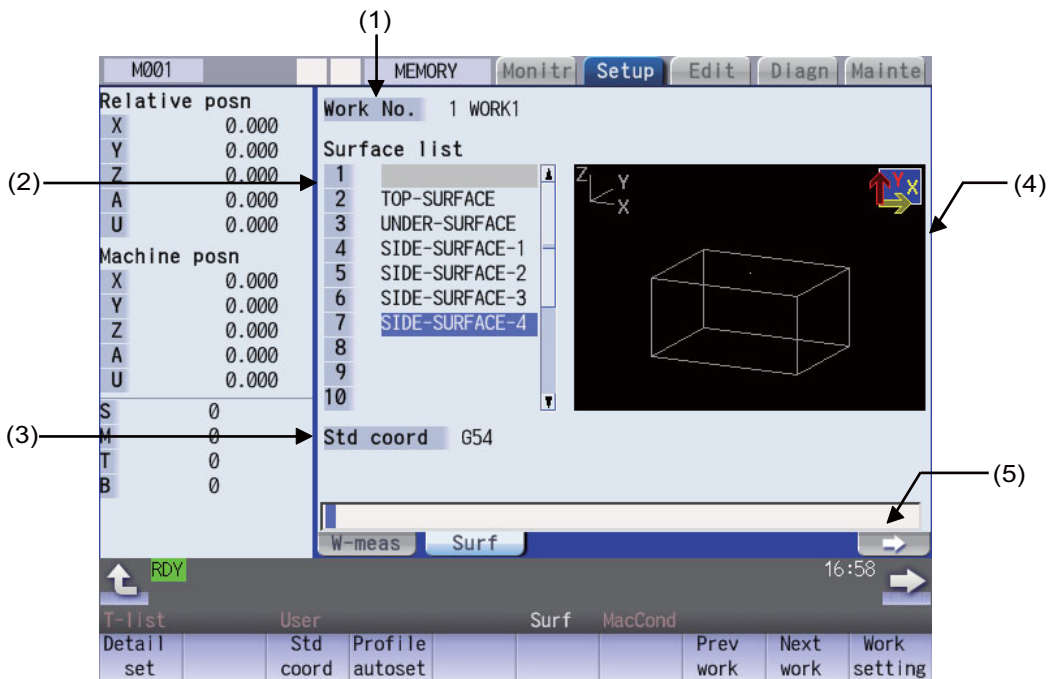

**Display items**

| Display items               | Description                                                                                                                                                                                                                                                                                                                                                            |
|-----------------------------|------------------------------------------------------------------------------------------------------------------------------------------------------------------------------------------------------------------------------------------------------------------------------------------------------------------------------------------------------------------------|
| (1) Work No.                | Displays the workpiece to which a machining surface is registered. The workpiece size, etc. are set through the work setting screen which is opened by the menu [Work setting].                                                                                                                                                                                        |
| (2) Surface list            | Displays a list of machining surfaces registered to the workpiece. Besides BASE-SURFACE up to 16 surfaces can be registered in this list.                                                                                                                                                                                                                              |
| (3) Basic coordinate system | Displays the basic coordinate system of the workpiece (workpiece coordinate system G54, G55...).                                                                                                                                                                                                                                                                       |
| (4) Workpiece graphic       | Displays the workpiece and the registered surfaces in a graphic form. Displays the workpiece and the registered surfaces in a graphic form. The surface pointed by the cursor in the list is highlighted, and the X, Y and Z coordinate axes of the surface (feature coordinate system) are indicated with arrow marks. (X axis is in yellow, Y in red and Z in green) |
| (5) Input section           | Displays the key entered. The data entered here will be reflected in the current cursor position when the [INPUT] key is pressed.                                                                                                                                                                                                                                      |

## Menus (T code list search window)

| Menus          | Description                                                                                                                                                                                                                                                                                                                             |
|----------------|-----------------------------------------------------------------------------------------------------------------------------------------------------------------------------------------------------------------------------------------------------------------------------------------------------------------------------------------|
| Detail set     | This opens the surface detail screen as a pop-up window.<br>The origin and axial directions of the feature coordinate system defined on the selected surface can be set on the surface detail screen.                                                                                                                                   |
| Std coord      | This selects the basic coordinate system of the workpiece that is subject to surface registration (G54 to G59 and extended workpiece coordinate G54.1Pn). After selecting, the workpiece coordinate system is displayed as the basic coordinate system.<br>Pressing this switches to the menu [Std coord].                              |
| Profile autose | If this menu is pressed while the workpiece subject to surface registration is a block, the top, bottom and four side faces of the workpiece are automatically registered as machining surfaces. The coordinate systems (feature coordinate systems) of each surface are also registered automatically.                                 |
| Graphic Dir    | This changes the coordinate system direction of the workpiece graphic (graphic display of the surface). If the coordinate system direction is switched using this menu, it is reflected on the workpiece graphic on the details/work setting screen, and held even after the power is turned OFF and ON.                                |
| Graphic Rot    | This switches the workpiece graphic (graphic display of the surface) by rotating it 90 degrees at a time around the vertical direction. The rotation by this menu is reflected on the workpiece graphic on the details/work setting screen, and held even after the power is turned ON again.                                           |
| Prev work      | This changes the workpiece subject to surface registration to the previous workpiece. If there is no previous workpiece, the last workpiece is displayed.                                                                                                                                                                               |
| Next work      | This changes the workpiece subject to surface registration to the next workpiece. If there is no next work, the first work is displayed.                                                                                                                                                                                                |
| Work setting   | This opens the work setting screen as a pop-up window.<br>On this screen, multiple workpieces can be registered (name registration), and the workpiece form (type and size) and position can be set to each of the registered workpieces.                                                                                               |
| Surface copy   | This copies the surface data of the specified line (one line). (*1)(*3)(*4)(*5)<br>If the [INPUT] key is pressed without specifying the line, the line where cursor is displaying will be copied.                                                                                                                                       |
| Surface paste  | This writes the copied surface data (one line) to the line where the cursor is displaying. (*1)(*2)(*3)(*5)                                                                                                                                                                                                                             |
| Surface clear  | This clears the surface data of the specified line (multiple lines possible). (*5)(*6)<br>Methods: Specify the No. of surface to start and the No. to finish deleting.<br>(Example) 1/E: Delete all surface data.<br>The line where the cursor is displaying will be deleted if the [INPUT] key is pressed without specifying the line. |

If the size has not been set for the workpiece, the menus except for [Prev work], [Next work], and [Work setting] will be grayed out and non-selectable.

(\*1) If the surface data of the copied line is changed, the data will be revised when it is pasted.

(\*2) This operation is disabled for the machining target surface (a surface along which three orthogonal coordinate axes are controlled at present) or the surface "BASE-SURFACE". The following message appears.

Machining target surface: "Can't paste machining surface"  
Surface "BASE-SURFACE": "Paste error"

(\*3) If the surface data of the copied line is deleted, pasting the data will be disabled. The message "Paste error" is displayed.

(\*4) The copied line will be maintained even if the screen changes.

(\*5) When the data protection is valid, this operation will be disabled. The message "Data protect" is displayed.



(\*6) When a line is deleted, this operation is disabled for the machining target surface (a surface along which three orthogonal coordinate axes are controlled at present) the surface "BASE-SURFACE". The following message appears.

Machining target surface: "Can't clear machining surface"  
Surface "BASE-SURFACE": "Clear not possible"

If the range specified for this operation includes BASE-SURFACE or the machining target surface (a surface along which three orthogonal coordinate axes are controlled at present) (1/E, for example), the surface data except for the surface "BASE-SURFACE" and the machining target surface will be deleted.

## 9.2.1.1 Selecting Where to Register a Machining Surface

**Operation method**

- (1) Move the cursor to the line where a machine surface is registered by using arrow keys ([↑], [↓]).
- (2) Input the surface name.  The surface name is registered.  
When not registering a surface name, skip this and go to operation (3).
- (3) Select the menu [Detail set] or press the [INPUT] key.  This opens the surface detail screen as a pop-up window.

**Note**

- (1) Set the surface name with up to 15 one-byte characters (numbers, upper-case alphabets and the symbols that the system recognizes). If a one-byte lower-case alphabet is used for naming, it will be changed to the upper-case letter.  
Note that the following characters cannot be used.  
\\ / : , \* ? " < > | space  
A character string made of a single-byte zero only cannot be registered as a work name.
- (2) The operation cannot be operated if the size is not set to workpiece. The message "Setting error" is displayed.
- (3) When the data protection is valid, the surface name cannot be changed. The message "Data protect" is displayed.

## 9.2.1.2 Changing the Surface Name

**Operation method**

- (1) Move the cursor to the row where the name of machine surface needs to be changed using arrow keys ([↑], [↓]).
- (2) Input the surface name.  The surface name is registered.  
To clear the surface name, input "0" (one-byte zero).

**Note**

- (1) When this operation is operated to the surface "BASE-SURFACE", the message "Setting error" is displayed.
- (2) This operation cannot be operated to the machining target surface (a surface along which three orthogonal coordinate axes are controlled at present). The message "Can't set machining surface" is displayed.
- (3) When the data protection is valid, the surface name cannot be changed. The message "Data protect" is displayed.

## 9.2.1.3 Switching the Workpiece

**Operation method**

- (1) Press the menus [Prev work] and [Next work].



<When the menu [Prev work] is pressed>

This will change the workpiece subject to surface registration to the previous workpiece. If there is no previous workpiece, the last workpiece is displayed. (The workpiece that has not set the size is displayed, too.) The cursor moves to the top line.

<When the menu [Next work] is pressed>

This will change the workpiece subject to surface registration to the next workpiece. If there is no next work, the first work is displayed. (The workpiece that has not set the size is displayed, too.) The cursor moves to the top line.

## 9.2.1.4 Selecting the Basic Coordinate System

The basic coordinate system of the workpiece subject to surface registration can be changed by selecting the menu [Std coord] and then selecting the sub-menu to be displayed.

**Operation method**

<Selecting the coordinate system G54-G59>

- (1) Press the menu [Std coord].  
The screen returns to the main menu of the surface list screen when [Retn] is selected.



The sub-menu is displayed.

- (2) Press the menu [G56].



G56 is set to the basic coordinate system.  
The screen returns to the main menu of the surface list screen.

<Selecting the coordinate system G54.1P>

- (1) Press the menu [Std coord].  
  
(2) Select the menu [G54.1P].  
Highlight of the menu will be canceled by selecting the menu [Retn].  
The screen returns to the main menu of the surface list screen by selecting [Retn] again.



The sub-menu is displayed.



The message "Input P number" is displayed.  
The menu is highlighted.

- (3) Input "20" and press the [INPUT] key.



G54.1P20 is set to the basic coordinate system.  
The screen returns to the main menu of the surface list screen.

**Note**

- (1) The basic coordinate system of the workpiece to which the machining target surface (a surface along which three orthogonal coordinate axes are controlled at present) is registered cannot be changed. The message "Can't set work including mach surface" is displayed.
- (2) When the data protection is valid, the basic coordinate system cannot be changed. The message "Data protect" is displayed.

## 9.2.1.5 Automatically Registering Top and Side Faces as Machining Surfaces

By pressing the menu [Profile auto set], the top, bottom and four side faces of the workpiece are automatically registered as machining surfaces. The coordinate systems (feature coordinate systems) of each surface are also registered automatically.

**Operation method**

- |                                         |   |                                                                                                           |
|-----------------------------------------|---|-----------------------------------------------------------------------------------------------------------|
| (1) Select the menu [Profile auto set]. | ➔ | The menu will be highlighted and the confirmation message "Execute auto-registration?(Y/N)" is displayed. |
| (2) Press the [Y] or [INPUT] key.       | ➔ | The automatic registration operates and the message "Auto-registration completed" is displayed.           |

**Note**

- (1) This operation is valid when the workpiece form is block. If the form is other than block, the message "Setting error" is displayed.
- (2) When any of the workpiece size (X, Y and Z directions) is not set, the menu [Profile auto set] will be grayed out and non-selectable.
- (3) The surface names to be registered are as follows:

|                |                                                                                           |
|----------------|-------------------------------------------------------------------------------------------|
| TOP-SURFACE    | A surface whose normal direction is +Z of the basic coordinate system                     |
| UNDER-SURFACE  | A surface whose normal direction is -Z of the basic coordinate system                     |
| SIDE-SURFACE-1 | A surface whose normal direction is +X of the basic coordinate system                     |
| SIDE-SURFACE-2 | The side surface that comes first when turning clockwise about Z axis from SIDE-SURFACE-1 |
| SIDE-SURFACE-3 | The side surface that comes second when turning clockwise about Z axis from SIDESURFACE-1 |
| SIDE-SURFACE-4 | The side surface that comes third when turning clockwise about Z axis from SIDE-SURFACE-1 |

- (4) This operation is disabled if 11 or more surfaces are registered besides those registered by this operation. The message "Setting error" is displayed.
- (5) If no surface name is registered, but the surface's coordinate system has been registered (the origin and coordinate axis directions of the feature coordinate system are other than zero), the surface is recognized as registered.
- (6) When the workpiece size is changed, this operation needs to be performed again because the coordinate systems set to each surface will shift. The setting of surface registered by this operation will be overwritten. However, the surface that is not able to overwrite (the registered surface is deleted or the name is changed) the setting will be registered again. (A renamed surface will be treated as the other surface.)
- (7) If a surface to register by this operation is the machining target surface (a surface along which three orthogonal coordinate axes are controlled at present), this operation cannot be operated. The message "Can't set machining surface" is displayed.
- (8) When the data protection is valid, this operation will be disabled. The message "Data protect" is displayed.
- (9) If there are two surfaces having the same name to be overwritten, the surface with the smaller No. will be overwritten. If the surface is the machining target surface this operation cannot be operated. The message "Can't set machining surface" is displayed.
- (10) There will be no data to be changed when error occurred and automatic register fails.

(11) Listed below are the surface names and data that are automatically set with [Profile auto set].

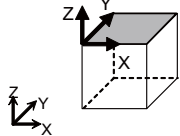
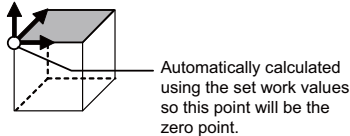
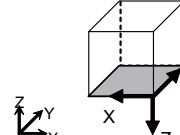
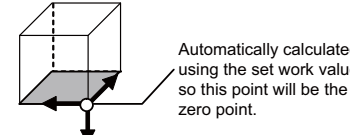
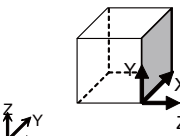
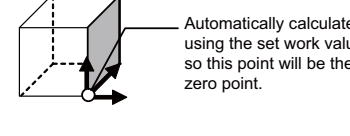
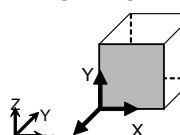
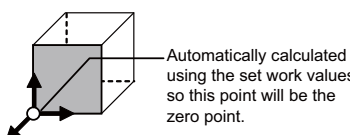
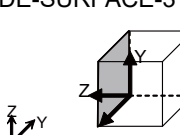
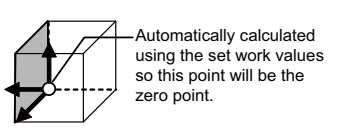
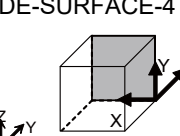
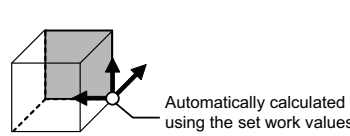
| Surface name                                                                                                 | Feature coordinate origin                                                           | Axis direction   | Method                  | Setting value                     |
|--------------------------------------------------------------------------------------------------------------|-------------------------------------------------------------------------------------|------------------|-------------------------|-----------------------------------|
| <b>TOP-SURFACE</b><br>      |    | Z axis direction | A point on the axis (+) | X: 0.000<br>Y: 0.000<br>Z: 1.000  |
|                                                                                                              |                                                                                     | X axis direction | A point on the axis (+) | X: 1.000<br>Y: 0.000<br>Z: 0.000  |
| <b>UNDER-SURFACE</b><br>    |    | Z axis direction | A point on the axis (+) | X: 0.000<br>Y: 0.000<br>Z: -1.000 |
|                                                                                                              |                                                                                     | X axis direction | A point on the axis (+) | X: -1.000<br>Y: 0.000<br>Z: 0.000 |
| <b>SIDE-SURFACE-1</b><br>   |    | Z axis direction | A point on the axis (+) | X: 1.000<br>Y: 0.000<br>Z: 0.000  |
|                                                                                                              |                                                                                     | X axis direction | A point on the axis (+) | X: 0.000<br>Y: 1.000<br>Z: 0.000  |
| <b>SIDE-SURFACE-2</b><br>  |   | Z axis direction | A point on the axis (+) | X: 0.000<br>Y: -1.000<br>Z: 0.000 |
|                                                                                                              |                                                                                     | X axis direction | A point on the axis (+) | X: 1.000<br>Y: 0.000<br>Z: 0.000  |
| <b>SIDE-SURFACE-3</b><br> |  | Z axis direction | A point on the axis (+) | X: -1.000<br>Y: 0.000<br>Z: 0.000 |
|                                                                                                              |                                                                                     | X axis direction | A point on the axis (+) | X: 0.000<br>Y: -1.000<br>Z: 0.000 |
| <b>SIDE-SURFACE-4</b><br> |  | Z axis direction | A point on the axis (+) | X: 0.000<br>Y: 1.000<br>Z: 0.000  |
|                                                                                                              |                                                                                     | X axis direction | A point on the axis (+) | X: -1.000<br>Y: 0.000<br>Z: 0.000 |

TOP-SURFACE is a surface whose normal direction is +Z of the basic coordinate system.

UNDER-SURFACE is a surface whose normal direction is -Z of the basic coordinate system.

SIDE-SURFACE-1 is a surface whose normal direction is +X of the basic coordinate system.

SIDE-SURFACE-2 to 4 are the surfaces obtained by rotating "SIDE-SURFACE1" about the Z axis of the basic coordinate system.

## 9.2.1.6 Switching the Coordinate System Direction of a Workpiece Graphic

The coordinate system direction of the workpiece graphic (graphic display of the surface) can be switched to three coordinate system directions using the menu [Graphic dir] or [Graphic Rot]. The coordinate system direction of the workpiece graphic is reflected on the workpiece setting screen, Surface detail screen, and surface detail screen of the monitor screen, and the parameter "#8980 R-Navi graphic dir" is also updated.

Each time the menu [Graphic dir] is pressed, the direction of the workpiece graphic is switched in the order of (1) to (3) as shown below:

- (1) #8980 R-Navi graphic direction = 0 (XYZ)

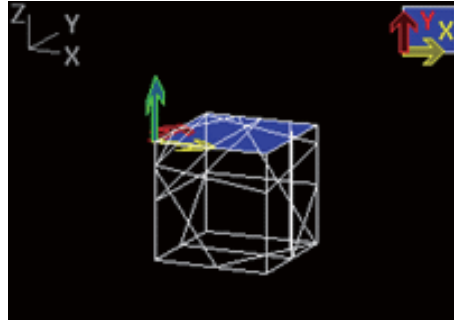

- (2) #8980 R-Navi graphic direction = 1 (YZX)

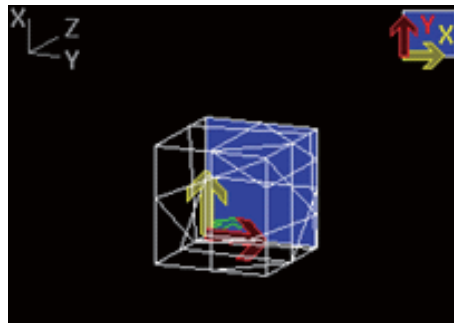

- (3) #8980 R-Navi graphic direction = 2 (ZXY)

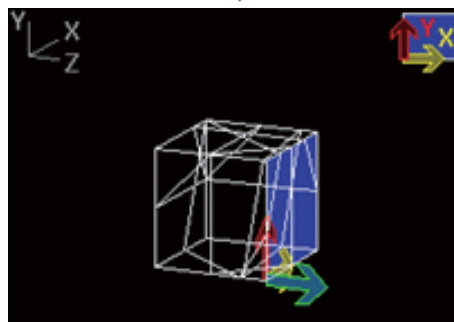



Each time the menu [Graphic Rot] is pressed, the direction of the workpiece graphic is switched in the order of (1) to (4) as shown below:

#8980 R-Navi graphic direction = 0 (XYZ)

(1) Default view

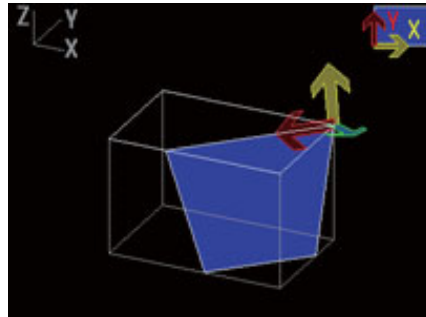

(2) Rotated by 90 degrees from the default view

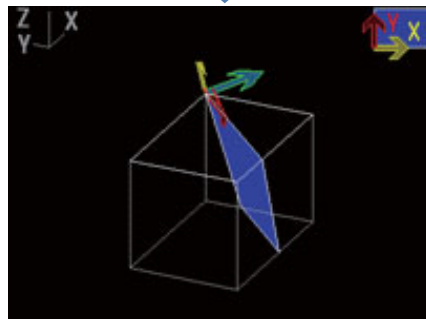

(3) Rotated by 180 degrees from the default view

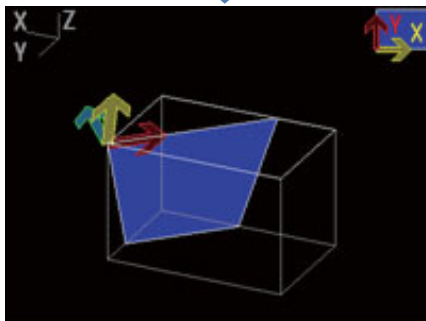

(4) Rotated by 270 degrees from the default view

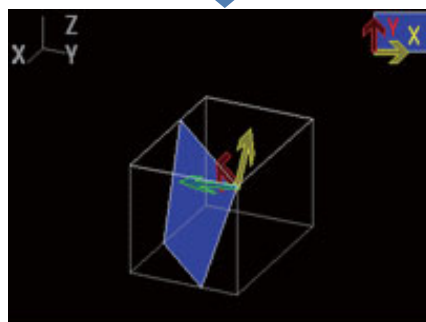

### Note

- (1) When data protection is valid, the coordinate system direction of the workpiece graphic can be switched using the menu, but the parameter value is not rewritten. In this case, when the power is turned ON again, the coordinate system direction of the workpiece graphic reverts to the same graphic direction that the parameter value is in.
- (2) The view direction of the guide drawing is not switched due to the setting of the parameter or this menu.

9.2.2 Registering and Setting the Workpiece (on the Work Setting Screen)

When the menu [Work setting] is pressed the workpiece setting screen opens as a pop-up window. On this screen, name, form, size, and position of the workpiece can be set.

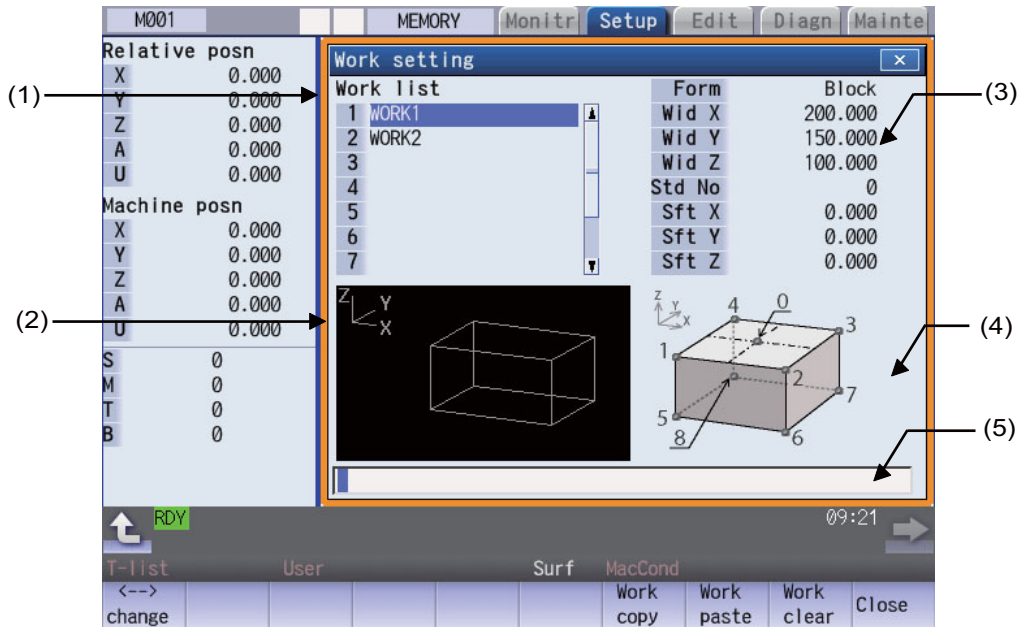

Display items

| Display items         | Description                                                                                                                                                                                                                                              |
|-----------------------|----------------------------------------------------------------------------------------------------------------------------------------------------------------------------------------------------------------------------------------------------------|
| (1) Work list         | Displays a list of currently registered workpieces. Up to 10 workpieces can be registered in this list.                                                                                                                                                  |
| (2) Workpiece graphic | Displays the form of the workpiece in 3D which is pointed by the cursor in the list.                                                                                                                                                                     |
| (3) Work setting      | Displays the setting value of the workpiece pointed by the cursor in the list. The number of digits after the decimal point will obey the parameter #1003 iunit of the 1st part system. (Example) - 99999.999 to 99999.999 (mm) (When "#1003 iunit"= B ) |
| (4) Guide graphic     | Displays the guide graphic that is related to the workpiece pointed by the cursor in the list.                                                                                                                                                           |
| (5) Input section     | Displays the key entered. The data entered here will be reflected in the current cursor position when the [INPUT] key is pressed.                                                                                                                        |

## Menus when the cursor is on the workpiece list

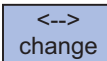
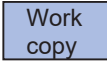
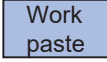
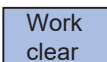
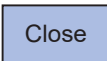
| Menus                                                                             | Description                                                                                                                                                                                                                                                                                                                                     |
|-----------------------------------------------------------------------------------|-------------------------------------------------------------------------------------------------------------------------------------------------------------------------------------------------------------------------------------------------------------------------------------------------------------------------------------------------|
|  | This moves the cursor between workpiece list and workpiece setting.                                                                                                                                                                                                                                                                             |
|  | This copies the data of workpiece pointed by the cursor (by one line). (*1)(*3)(*4)(*5)                                                                                                                                                                                                                                                         |
|  | This writes the copied workpiece data (one line) to the line where the cursor is displaying.<br>(*1)(*2)(*3)(*5)<br>The copied workpiece data will be deleted when pasted.                                                                                                                                                                      |
|  | This clears the workpiece data of the specified line (multiple lines possible). (*5)(*6)<br>Methods: Specify the No. of workpiece data to start and the No. to finish deleting.<br>(Example) 1/E: Delete all workpiece data.<br>The line where cursor is displaying will be deleted if the [INPUT] key is selected without specifying the line. |
|  | This closes the pop-up window and quits this function.                                                                                                                                                                                                                                                                                          |

(\*1) If the surface data being copied is changed, the data will be revised when it is pasted.

(\*2) This operation cannot be operated to the workpiece that includes the machining target surface (a surface along which three orthogonal coordinate axes are controlled at present). The message "Can't paste work including mach surface" is displayed.

(\*3) If the surface data being copied is deleted, the paste cannot be done. The message "Paste error" is displayed.



(\*4) The copied data will be deleted when the window is closed.

(\*5) When the data protection is valid, this operation will be disabled. The message "Data protect" is displayed.

(\*6) When a line is deleted, this operation is disabled for a workpiece that includes the machining target surface (a surface along which three orthogonal coordinate axes are controlled at present) and the message "Can't clear machining surface" is displayed.

If the range specified for this operation includes the workpiece that has the machining target surface (a surface along which three orthogonal coordinate axes are controlled at present) (1/E, for example), the workpieces except for the workpiece that includes the machining target surface will be deleted.

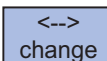
## Menus when the cursor is on the workpiece setting list

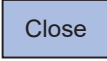
| Menus                                                                               | Description                                                                                                                                                    |
|-------------------------------------------------------------------------------------|----------------------------------------------------------------------------------------------------------------------------------------------------------------|
|  | This moves the cursor between workpiece list and workpiece setting.                                                                                            |
|  | The workpiece form will turn to block when this menu is selected.<br>If the cursor is outside the form area, this menu will be grayed out and non-selectable.  |
|  | The workpiece form will turn to pillar when this menu is selected.<br>If the cursor is outside the form area, this menu will be grayed out and non-selectable. |
|  | This closes the pop-up window and quits this function.                                                                                                         |

9.2.2.1 Registering the Workpiece

**Operation method**

- (1) Move the cursor to the workpiece list by using the menu [ <-> change]. ➔ Move the cursor to the top of the workpiece list.  
 Also, the cursor can be moved by tab keys ([←], [→]) to workpiece list.
- (2) Move the cursor to a line where no workpiece is registered.
- (3) Input the workpiece name. ➔ The name of workpiece is registered, and the cursor moves to the form line of workpiece setting.  
 If naming the workpiece is unnecessary, select [INPUT]. Also, the menu corresponding to the value of form is valid.
- (4) Select the form menu ([Block], [Pillar]) that needs to be set. ➔ The selected form will be reflected to the line of form and the cursor moves down a line.

Setting contents differs by the selected workpiece form.

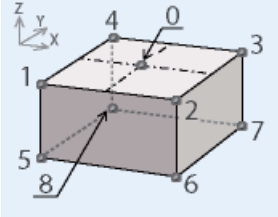
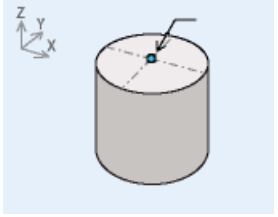
| Form   | Guide graphic                                                                       | Item   | Description                                                                                                        | Setting range (*1)                                                                      |
|--------|-------------------------------------------------------------------------------------|--------|--------------------------------------------------------------------------------------------------------------------|-----------------------------------------------------------------------------------------|
| Block  |   | Wid X  | Width in the X direction                                                                                           | 0.001mm(*2) - 99999.999mm                                                               |
|        |                                                                                     | Wid Y  | Width in the Y direction                                                                                           | 0.001mm(*2) - 99999.999mm                                                               |
|        |                                                                                     | Wid Z  | Width in the Z direction                                                                                           | 0.001mm(*2) - 99999.999mm                                                               |
|        |                                                                                     | Std No | Set a point to serve as a reference when setting the basic coordinate system's origin by the No. on guide graphic. | 0: A center of the top<br>1 to 4: An angle of the top<br>5 to 8: An angle of the bottom |
|        |                                                                                     | Sft X  | Shift distance from the point of Std No to the basic coordinate system's origin (in the X direction)               | -99999.999mm - 99999.999mm                                                              |
|        |                                                                                     | Sft Y  | Shift distance from the point of Std No to the basic coordinate system's origin (in the Y direction)               | -99999.999mm - 99999.999mm                                                              |
|        |                                                                                     | Sft Z  | Shift distance from the point of Std No to the basic coordinate system's origin (in the Z direction)               | -99999.999mm - 99999.999mm                                                              |
| Pillar |  | Dia D  | Diameter of the pillar                                                                                             | 0.001mm(*2) - 99999.999mm                                                               |
|        |                                                                                     | Hgt Z  | Height of the pillar                                                                                               | 0.001mm(*2) - 99999.999mm                                                               |
|        |                                                                                     | Sft X  | Shift distance from the top face's center to the basic coordinate system's origin (in the X direction)             | -99999.999mm - 99999.999mm                                                              |
|        |                                                                                     | Sft Y  | Shift distance from the top face's center to the basic coordinate system's origin (in the Y direction)             | -99999.999mm - 99999.999mm                                                              |
|        |                                                                                     | Sft Z  | Shift distance from the top face's center to the basic coordinate system's origin (in the Z direction)             | -99999.999mm - 99999.999mm                                                              |

(\*1) These values follow the setting of "#1003 iunit" for the 1st part system.

(\*2) Inputting 0 is possible.

(5) Input the workpiece size.



The value is input to the line where cursor is displaying and the cursor moves down a line.

**Note**

(1) Despite the presence of workpiece name, the workpiece will be treated as registered when its size meets the followings:

- Block: The three axes (X, Y and Z) are defined
- Pillar: The diameter D and height Z are defined

(2) Set the workpiece name with up to 20 one-byte characters (numbers, upper-case alphabets and the symbols that the system recognizes). If a one-byte lower-case alphabet is used for naming, it will be changed to the upper-case letter.

Note that the following characters cannot be used:

\ / : , \* ? " < > | space

A character string made of a single-byte zero only cannot be registered as a work name.

(3) When the data protection is valid, registering a workpiece is disabled. The message "Data protect" is displayed.

**Work size setting examples**

|  |                                                                                                                                                                                                                                                                      |
|--|----------------------------------------------------------------------------------------------------------------------------------------------------------------------------------------------------------------------------------------------------------------------|
|  | <p>Form: Block<br/>                 Wid X: 50.000<br/>                 Wid Y: 30.000<br/>                 Wid Z: 20.000<br/>                 Std No: 1<br/>                 Sft X: 0.000<br/>                 Sft Y: 0.000<br/>                 Sft Z: 0.000</p>     |
|  | <p>Form: Block<br/>                 Wid X: 50.000<br/>                 Wid Y: 30.000<br/>                 Wid Z: 20.000<br/>                 Std No: 5<br/>                 Sft X: -10.000<br/>                 Sft Y: -5.000<br/>                 Sft Z: -4.000</p> |
|  | <p>Form: Pillar<br/>                 Dia D: 60.000<br/>                 Hgt Z: 20.000<br/>                 Sft X: 0.000<br/>                 Sft Y: 0.000<br/>                 Sft Z: 0.000</p>                                                                      |
|  | <p>Form: Pillar<br/>                 Dia D: 60.000<br/>                 Hgt Z: 20.000<br/>                 Sft X: 50.000<br/>                 Sft Y: 35.000<br/>                 Sft Z: 5.000</p>                                                                    |

## 9.2.2.2 Changing the Workpiece Name

**Operation method**

- |                                                                                                                                                          |   |                                                                                               |
|----------------------------------------------------------------------------------------------------------------------------------------------------------|---|-----------------------------------------------------------------------------------------------|
| (1) Move the cursor to the workpiece list by using the menu [ <--> change].<br>Also, the cursor can be moved by tab keys ([ ←], [→ ]) to workpiece list. | ➔ | Move the cursor to the top of the workpiece list.                                             |
| (2) Move the cursor to a line where the workpiece is registered using arrow keys ([↑], [↓]).                                                             |   |                                                                                               |
| (3) Input the workpiece name.<br>To clear the workpiece name, input "0"(one-byte 0).                                                                     | ➔ | The name of workpiece is changed, and the cursor moves to the form line of workpiece setting. |

**Note**

- (1) Form, size, data of the surface will not change by changing the name.
- (2) The name of workpiece for which the machining target surface (a surface along which three orthogonal coordinate axes are controlled at present) has been registered, cannot be changed.  
The message "Can't set work including mach surface" is displayed.
- (3) When the data protection is valid, a workpiece name cannot be changed. The message "Data protect" is displayed.

## 9.2.2.3 Changing the Form of the Work

**Operation method**

- |                                                                                                                                                                                                                                                                                                                                                                                                                         |   |                                                                                                                                                        |
|-------------------------------------------------------------------------------------------------------------------------------------------------------------------------------------------------------------------------------------------------------------------------------------------------------------------------------------------------------------------------------------------------------------------------|---|--------------------------------------------------------------------------------------------------------------------------------------------------------|
| (1) Move the cursor to workpiece setting by using the menu [ <--> change].<br>If the cursor is already on the workpiece setting, move the cursor to the line of the workpiece shape by using arrow keys ([↑], [↓]).<br>The cursor can be moved by tab keys ([ ←], [→ ]) to workpiece setting.<br>Also, the cursor will move to workpiece setting by selecting the [INPUT] key when the cursor is in the workpiece list. | ➔ | Move the cursor to the top of workpiece setting.<br>The menu corresponding to the value of form becomes valid.                                         |
| (2) Select the form menu ([Block], [Pillar]) that needs to be set.                                                                                                                                                                                                                                                                                                                                                      | ➔ | The selected form will be reflected to the line of form and the cursor moves down a line.<br>The guide graphic changes according to the selected form. |

**Note**

- (1) This operation cannot be operated to the workpiece that includes the machining target surface (a surface along which three orthogonal coordinate axes are controlled at present). The message "Can't set work including mach surface" is displayed.
- (2) Even if the form changes, the size to be displayed is the data before the change, and the data of surface will not be changed.
- (3) When the data protection is valid, a workpiece form cannot be changed. The message "Data protect" is displayed.

## 9.2.2.4 Changing the Workpiece Size

**Operation method**

- |                                                                                                                                                                                                                                                                                                                                                                              |   |                                                                                                    |
|------------------------------------------------------------------------------------------------------------------------------------------------------------------------------------------------------------------------------------------------------------------------------------------------------------------------------------------------------------------------------|---|----------------------------------------------------------------------------------------------------|
| <p>(1) Move the cursor to workpiece setting by using the menu [ &lt;--&gt; change]. If the cursor is already on the workpiece setting this operation is unnecessary.<br/>The cursor can be moved by tab keys ([←], [→]) to workpiece setting.<br/>Also, the cursor will move to workpiece setting by selecting the [INPUT] key when the cursor is in the workpiece list.</p> | ➔ | <p>Move the cursor to the top of workpiece setting.</p>                                            |
| <p>(2) Move the cursor to the line of size that needs to be set using arrow keys ([↑], [↓]).</p>                                                                                                                                                                                                                                                                             |   |                                                                                                    |
| <p>(3) Input the workpiece size.</p>                                                                                                                                                                                                                                                                                                                                         | ➔ | <p>The value is input to the line where cursor is displaying and the cursor moves down a line.</p> |

**Note**

- (1) This operation cannot be operated to the workpiece that includes the machining target surface (a surface along which three orthogonal coordinate axes are controlled at present). The message "Can't set work including mach surface" is displayed.
- (2) The data of surface will not change by changing the size. Set again on the surface detail screen.
- (3) When the data protection is valid, a workpiece size cannot be changed. The message "Data protect" is displayed.
- (4) The setting contents differ by selected workpiece form. Refer to "9.2.2.1 Registering the Workpiece" for details.

9.2.3 Setting the Details of the Surface (on the Surface Detail Screen)

By selecting the menu [Detail set] of the surface list screen, this opens the surface detail screen as a pop-up window. On this screen the coordinate origin (feature coordinate origin) and coordinate axis orientation of a coordinate system defined along the surface can be set.

**Note**

- (1) This screen is not displayed in the following case. The message "Setting error" is displayed.
  - When the surface "BASE-SURFACE" is selected on the surface list screen.

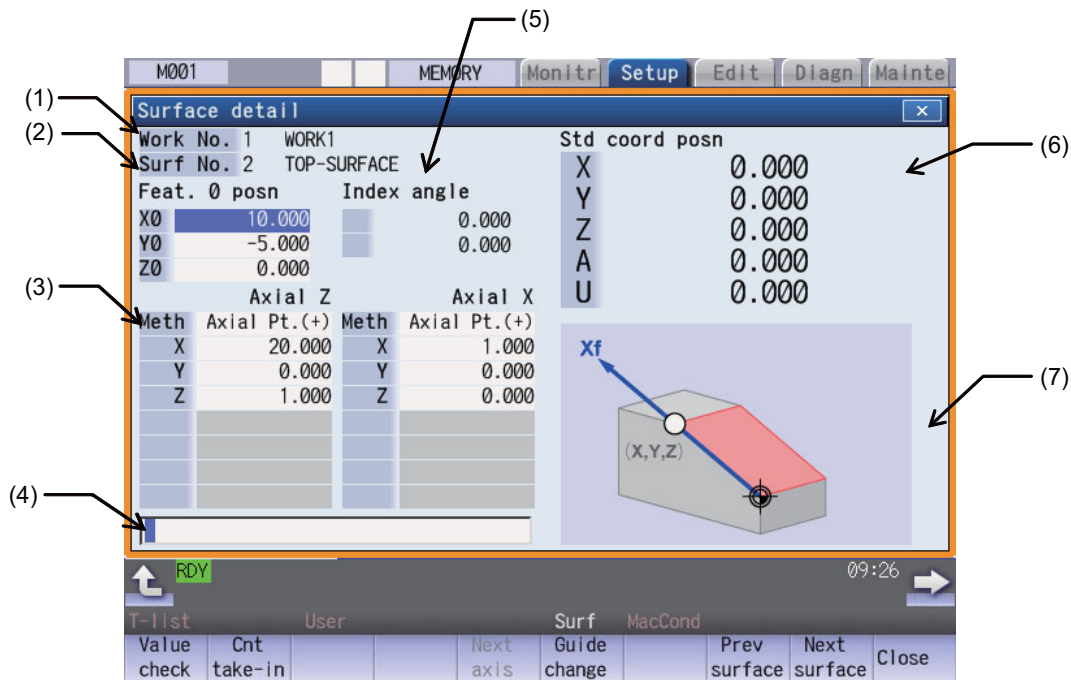

**Display items**

| Display items                   | Description                                                                                                                                                                                                                                                                                                                                                                                                                                             |
|---------------------------------|---------------------------------------------------------------------------------------------------------------------------------------------------------------------------------------------------------------------------------------------------------------------------------------------------------------------------------------------------------------------------------------------------------------------------------------------------------|
| (1) Workpiece No. / Surface No. | Displays the work and surface of current settings.                                                                                                                                                                                                                                                                                                                                                                                                      |
| (2) Feature coordinate origin   | Displays the settings of surface coordinate origin (feature coordinate origin). The number of digits after the decimal point will obey the parameter #1003 iunit of the 1st part system.<br>(Example) - 99999.999 to 99999.999 (mm) (When "#1003 iunit" = B )                                                                                                                                                                                           |
| (3) Axis direction setting      | Displays the designation type of two coordinate axis directions of the surface, and the values (coordinates, rotation type, etc. ) needed for the designation type. The initial values of the designation type and the axis combination can be set by #8954 and #8955.<br>The number of digits after the decimal point will obey the parameter #1003 iunit of the 1st part system.<br>(Example) - 99999.999 to 99999.999 (mm) (When "#1003 iunit" = B ) |
| (4) Input section               | Displays the key entered. The data entered here will be reflected in the current cursor position when the [INPUT] key is pressed.                                                                                                                                                                                                                                                                                                                       |

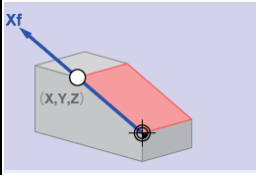
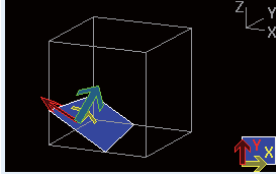

| Display items                         | Description                                                                                                                                                                                                                                                                                                                                                                                                                                                                                                                                                                                                                                                                                                                                                                                                                                                   |
|---------------------------------------|---------------------------------------------------------------------------------------------------------------------------------------------------------------------------------------------------------------------------------------------------------------------------------------------------------------------------------------------------------------------------------------------------------------------------------------------------------------------------------------------------------------------------------------------------------------------------------------------------------------------------------------------------------------------------------------------------------------------------------------------------------------------------------------------------------------------------------------------------------------|
| (5) Index angle                       | <p>Displays the index angle calculated from the values set to the currently displaying two coordinate axes.</p> <p>The number of digits after the decimal point is fixed to three.</p> <p>The axis names to be displayed on the index angle are different according to the machine configuration.</p> <pre> Index angle A      0.000 ← Rotary axis 1 C      0.000 ← Rotary axis 2 </pre> <ul style="list-style-type: none"> <li>♦ Tool tilt type<br/>Displays the axis name of #7932 ROTAXT2 for "Rotary axis1", the axis name of #7922 ROTAXT1 for "Rotary axis 2".</li> <li>♦ Table tilt type<br/>Displays the axis name #7942 ROTAXW1 for "Rotary axis1", the axis name #7952 ROTAXW2 for "Rotary axis 2"</li> <li>♦ Combined type<br/>Displays the axis name #7932 ROTAXT2 for "Rotary axis1", the axis name #7952 ROTAXW2 for "Rotary axis 2"</li> </ul> |
| (6) Basic coordinate position counter | <p>Displays the value of the basic coordinate position counter (the counter that shows the coordinate position of basic coordinate system).</p> <p>Use the menu [Next axis] to open the counter of the 6th or subsequent axis.</p>                                                                                                                                                                                                                                                                                                                                                                                                                                                                                                                                                                                                                            |
| (7) Guide graphic/workpiece graphic   | <p>Displays either the workpiece graphic or the guide graphic that illustrates the registration method of the currently selected coordinate axes.</p> <p>Switching between guide graphic and work graphic is performed by using the menu [Guide change].</p>                                                                                                                                                                                                                                                                                                                                                                                                                                                                                                                                                                                                  |

| Menus        |                                                                                                                                                                                                                                                                                                                                                                                                                                                                                              |
|--------------|----------------------------------------------------------------------------------------------------------------------------------------------------------------------------------------------------------------------------------------------------------------------------------------------------------------------------------------------------------------------------------------------------------------------------------------------------------------------------------------------|
| Menus        | Description                                                                                                                                                                                                                                                                                                                                                                                                                                                                                  |
| Value check  | This menu enables you to check if it is possible to define a surface using the set coordinate axial directions.                                                                                                                                                                                                                                                                                                                                                                              |
| Cnt take-in  | This sets the cursor position values in the basic coordinate position counter.<br><Note><br>♦The menu will be grayed out if the cursor is in display item (3) "Axis direction setting" and the counter take-in has been disabled by the selected designation type.                                                                                                                                                                                                                           |
| Next axis    | This switches the axes displayed on the basic coordinate position counter between the 1st to 5th axes and the 6th and subsequent axes when the valid axis number is six or more.<br><Note><br>♦The menu will be grayed out and non-selectable when the number of valid axes is five or less.                                                                                                                                                                                                 |
| Guide change | This switches between guide graphic and work graphic.<br><br><div style="display: flex; justify-content: space-around; align-items: center;"> <div style="text-align: center;"> <p>[Guide graphic]</p>  </div> <div style="font-size: 2em;">↔</div> <div style="text-align: center;"> <p>[Work graphic]</p>  </div> </div> |
| Prev surface | This switches the setting surface to the previous surface. If there is no previous surface, the last surface is displayed.                                                                                                                                                                                                                                                                                                                                                                   |
| Next surface | This switches the setting surface to next surface. If there is no next surface, the first surface is displayed.                                                                                                                                                                                                                                                                                                                                                                              |
| Close        | This closes the pop-up window and quits this function.                                                                                                                                                                                                                                                                                                                                                                                                                                       |
| Comb change  | This changes the combination of two coordinate axes to be specified.                                                                                                                                                                                                                                                                                                                                                                                                                         |
| Axial rotate | This menu rotates the coordinate system (reversing the Z axis direction or rotating X/Y coordinates by 90 deg.) with respect to the coordinate axes defined along the machining surface.                                                                                                                                                                                                                                                                                                     |

### Note

(1) The menus on the 1st page are different if the cursor is on the axial direction setting type.

9.2.3.1 Moving the Cursor

The cursor moves by the tab keys ([←], [→]) and the arrow keys ([↑], [↓]) on the surface detail screen.

9.2.3.2 Setting the Surface Coordinate Origin (Feature Coordinate Origin)

Specify the surface coordinate origin (feature coordinate origin). The value of the coordinate origin is the offset from the basic coordinate system's origin. Also the X, Y and Z directions are those of the basic coordinate system.

**Note**

- (1) When this operation is performed for the machining target surface (a surface along which three orthogonal coordinate axes are controlled at present), the error message "Can't set machining surface" is displayed.
- (2) When the data protection is valid, entering or changing data is disabled on this screen. The message "Data protect" is displayed.

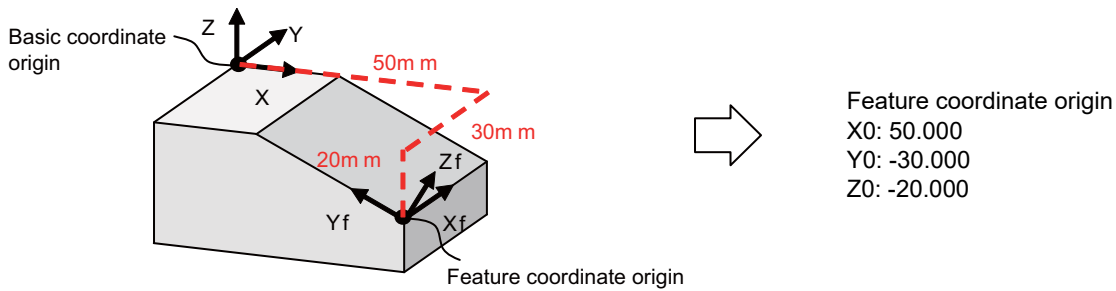

**Operation method**

- (1) Move the cursor to the feature coordinate origin. ➡ The cursor moves to the top of the feature coordinate origin.
- (2) Move the cursor to the line to set the value of origin.
- <When inputting the value directly>
- (3) Input the value of origin. ➡ The inputted value will be set in the cursor position.
- <To take in the value of the basic coordinate position counter (a counter that displays the position with respect to the basic coordinate system)>
- (3) Select the menu [Cnt take-in]. ➡ The value of the basic coordinate position counter will be set to the position of the counter.

**Note**

- (1) The counter values of the axes specified by the parameters #7900 RCDAX\_I to #7902 RCDAX\_K will be taken. The relation between the feature coordinate origin and the parameters is listed below. If any of the parameter settings is illegal or any of the axes is set as non-display ("#1069 no\_dsp" is "1"), the counter take-in will be disabled. In this case the message "Counter take in not possible" will appear.

| Feature coordinate origin | Corresponding parameter |
|---------------------------|-------------------------|
| X0                        | #7900 RCDAX_I           |
| Y0                        | #7901 RCDAX_J           |
| Z0                        | #7902 RCDAX_K           |

9.2.3.3 Specifying the Surface Coordinate Axial Directions

Specify the surface coordinate axial directions. There are five types of methods for specifying the coordinate axial directions: "Axial point (+)", "Longitude/Latitude", "Longitude/Projection angle", "Start point/End point" and "Index angle". "Axial point (+)", "Start point/End point", and "Index angle" can take in the value of the basic coordinate position counter by selecting the menu [Cnt take-in].

**Note**

- (1) When this operation is performed for the machining target surface (a surface along which three orthogonal coordinate axes are controlled at present), the error message "Can't set machining surface" is displayed.
- (2) When the data protection is valid, entering or changing data is disabled on this screen. The message "Data protect" is displayed.

**[Method 1] Axial point (+)**

With this method you specify one point, except for the feature coordinate origin, using an offset from the feature coordinate origin (an offset in the basic coordinate system direction), and the coordinate axial direction is determined by this point and the feature coordinate origin. The direction from the feature coordinate origin to the designated point is positive (+).

[Setting value]

Offset from the coordinate origin (feature coordinate origin).

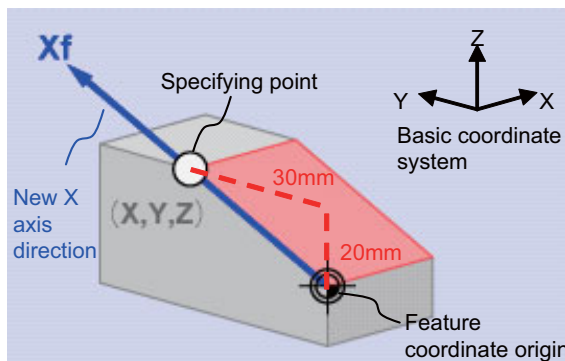

X axis direction  
 X: 0.000  
 Y: 30.000  
 Z: 20.000

**[Method 2] Longitude/Latitude**

This method specifies coordinate axial direction by rotating the axes of the basic coordinate system by the designated longitude and latitude. The plane to be used as the basis of the longitude and latitude varies depending on which coordinate axis to set.

[Setting value]

| Coordinate axis  | $\theta 1$ (TH1)            | $\theta 2$ (TH2)    |
|------------------|-----------------------------|---------------------|
| X axis direction | Rotation angle about Z axis | Angle from XY plane |
| Y axis direction | Rotation angle about Z axis | Angle from XY plane |
| Z axis direction | Rotation angle about X axis | Angle from YZ plane |

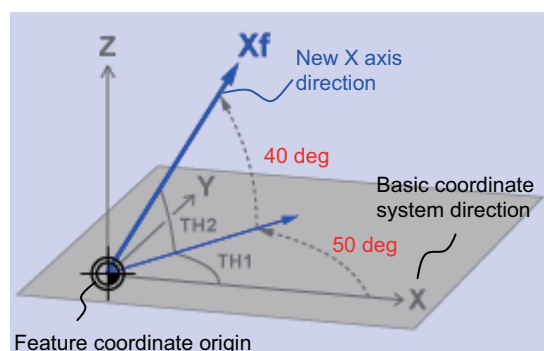

X axis direction  
 TH1: 50.000  
 TH2: -40.000

**[Method 3] Longitude/Projection angle**

This method specifies coordinate axial direction by rotating the axes of the basic coordinate system by the designated longitude and latitude. The plane to be used as the basis of the longitude and latitude varies depending on which coordinate axis to set.

[Setting value]

| Coordinate axis  | $\theta_1$ (TH1)            | $\theta_2$ (TH2)          |
|------------------|-----------------------------|---------------------------|
| X axis direction | Rotation angle about Z axis | Project angle on ZY plane |
| Y axis direction | Rotation angle about Z axis | Project angle on YZ plane |
| Z axis direction | Rotation angle about X axis | Project angle on ZY plane |

**Note**

(1) If you set 90 deg. or -90 deg. for TH1, the projected angle on the plane cannot be calculated. In this case the directions after rotated by TH1 will be the coordinate axial directions, regardless of the TH2 value.

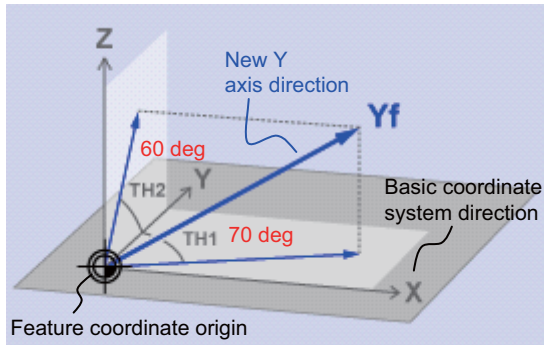

Y axis direction  
 TH1: -70.000  
 TH2: 60.000

**[Method 4] Start point/End point**

With this method you specify the start- and end-point coordinates by manual operation to specify the coordinate axial direction in the same direction as from the specified start-point to the end-point. The coordinate origin is that of the feature coordinate system, and the direction from the start point to the end point is positive.

[Setting value]

X, Y, Z: Start-point coordinate (basic coordinate position)  
 +X, +Y, +Z: End-point coordinate (basic coordinate position)

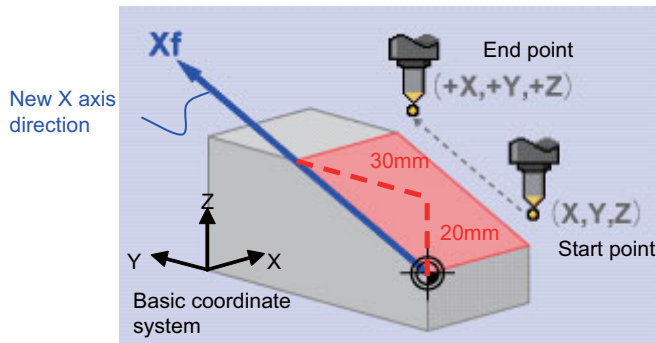

X axis direction  
 (Start point)  
 X : 30.000  
 Y : -50.000  
 Z : 25.000  
 (End point)  
 +X : 30.000  
 +Y : -20.000  
 +Z : 45.000

**[Method 5] Index angle**

With this method you directly specify the indexing angle in the Z axis direction. This method is unusable for the X and Y directions. The message "Setting error" is displayed. If you select the "Index angle" method for Z axis, and select the [Axial point (+)] or [Start point/End point] method for X and Y axes with all the settings set to "0.000", the X/Y directions are controlled to be in the basic coordinate system directions after surface indexing, regardless of the methods for X and Y. (When the X/Y directions have been set, the setting values will be observed.)

[Setting value]

$\theta 1$ (TH1): The angle of rotary axis B

$\theta 2$ (TH2): The angle of rotary axis C

(When the rotary axis is set to B or C)

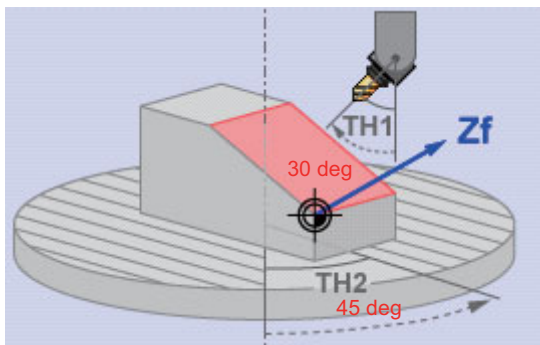

Z axis direction  
 TH1: 30.000  
 TH2: -45.000

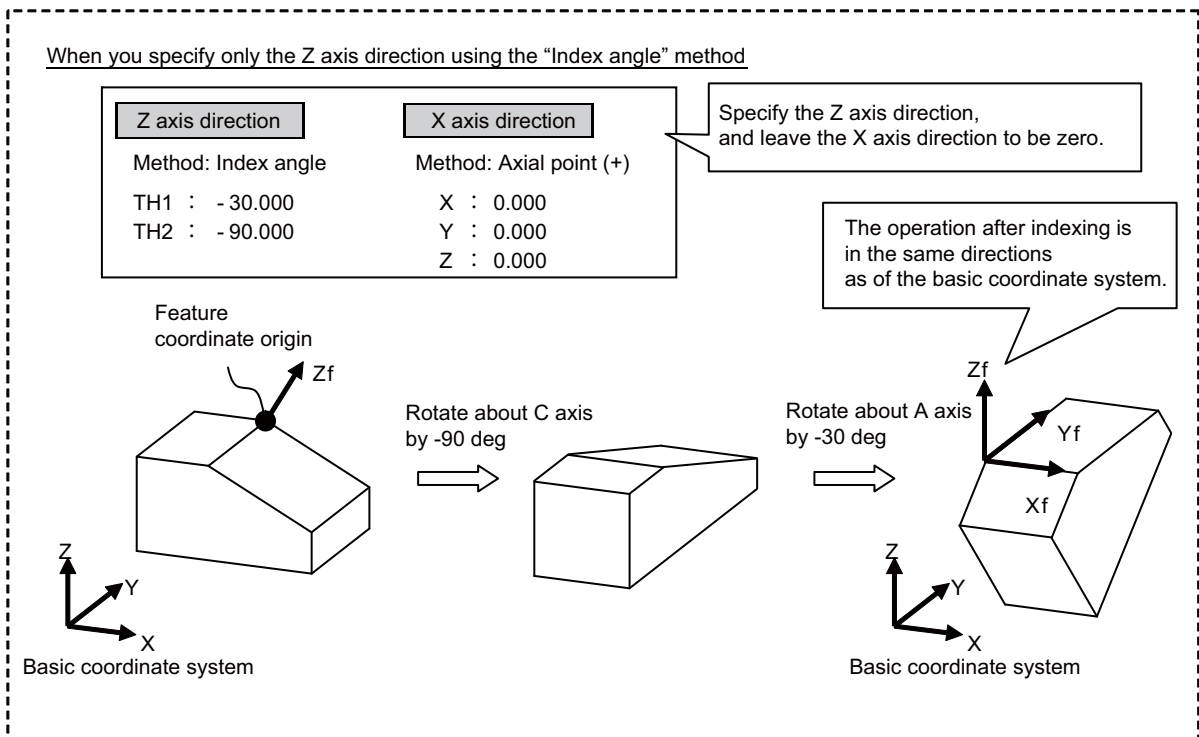





### Menus

When the cursor is moved to "Meth" (axial direction designation type), the menus on the 1st page will switch to the following ones. (The menus on the 2nd page will not change.)

| Menu              | Description                                                                                                                                                |
|-------------------|------------------------------------------------------------------------------------------------------------------------------------------------------------|
| Axial<br>Pt.(+)   | This is the method to specify the coordinate axial direction using an optional point (except for feature coordinate origin) and feature coordinate origin. |
| Long./<br>lat.    | This method specifies coordinate axial direction by rotating the axes of the basic coordinate system by the designated longitude and latitude.             |
| Long./<br>p-angle | This is the method to specify the coordinate axial direction by rotating the basic coordinate system axis by the specified longitude/projection angle.     |
| StartPt<br>/EndPt | This is the method to specify the coordinate axial direction using the manually specified start-point and end-point.                                       |
| Index<br>angle    | With this method you directly specify the indexing angle in the Z axis direction.                                                                          |

**Operation method**

- (1) Move the cursor to "Meth".  The menu change.
- (2) Select the menu [Long./ lat.].  The value of the specified method will be longitude/ projection angle.
- <When inputting the value directly>
- (3) Input the value.  The inputted value will be set in the cursor position.
- <To take in the value of the basic coordinate position counter (a counter that displays the position with respect to the basic coordinate system)>
- (3) Select the menu [Cnt take-in].  The value of the basic coordinate position counter will be set to the position of the counter.  
After setting, the cursor moves down a line.

**Note**

- (1) Which axis to use for taking in the counter value is determined by the parameters. The relation between the axes for taking in counter value and the parameters is listed below. If any of the parameter settings is illegal or any of the axes is set as non-display ("#1069 no\_dsp" is "1"), the counter take-in will be disabled. In this case the message "Counter take in not possible" will appear.

When the designated type is Axial point (+)

| Setting item | Corresponding parameter |
|--------------|-------------------------|
| X            | #7900 RCDAX_I           |
| Y            | #7901 RCDAX_J           |
| Z            | #7902 RCDAX_K           |

When the designated type is Start point/End point

| Setting item | Corresponding parameter |
|--------------|-------------------------|
| X            | #7900 RCDAX_I           |
| Y            | #7901 RCDAX_J           |
| Z            | #7902 RCDAX_K           |
| +X           | #7900 RCDAX_I           |
| +Y           | #7901 RCDAX_J           |
| +Z           | #7902 RCDAX_K           |

When the designated type is Index angle

| Setting item | Corresponding parameter |                 |               |
|--------------|-------------------------|-----------------|---------------|
|              | Tool tilt type          | Table tilt type | Combined type |
| TH1          | #7932 ROTAXT2           | #7942 ROTAXW1   | #7932 ROTAXT2 |
| TH2          | #7922 ROTAXT1           | #7952 ROTAXW2   | #7952 ROTAXW2 |





9.2.3.4 Checking the Setting Value of Coordinate Axis

Pressing the menu [Value check] enables you to check if it is possible to define a surface using the set coordinate axial directions. When defining a surface is allowed, the message "Setting value check completed" appears. In the following cases, defining a surface is judged as impossible, and the message "Can't define machining surface" appears.

- (1) When the designation method is "axial point (+)" or the set value of "Start point/End point" is "0".  
(When "Index angle" is selected for the Z axis, X/Y directions will be out of the scope of this check.)
- (2) When an angle formed by the set two coordinate axes is either "0 deg. or greater but 1 deg. or smaller" or "179 deg. or greater but 180 deg. or smaller".

9.2.3.5 Changing the Combination of Axial Direction

You can change the coordinate axial direction combination (Z/X, Z/Y, X/Y) to be displayed on coordinate axial direction setting.

| Operation method                   |                                                                                                                                                                                                                                               |
|------------------------------------|-----------------------------------------------------------------------------------------------------------------------------------------------------------------------------------------------------------------------------------------------|
| (1) Select the menu [Comb change]. |  The menu switches.<br>The menu of the currently selected axis combination will be highlighted.                                                              |
| (2) Select the menu [X/Y].         |  The coordinate axial direction of the coordinate axial direction setting changes to X/Y.<br>The menu returns to the main menu of the surface detail screen. |

**Note**

- (1) The setting value of coordinate axis will not change even if the axis combination is changed. Please set it again.
- (2) When this operation is performed for the machining target surface (a surface along which three orthogonal coordinate axes are controlled at present), the error message "Can't set machining surface" is displayed.
- (3) When the data protection is valid, entering or changing data is disabled on this screen. The message "Data protect" is displayed.

9.2.3.6 Switching the Surface

| Operation method                                       |                                                                                                                                                                                                                                                                                                                                                                                                                                                                                                                                                                                                                                                                                                                                                                                                                                                                                                                                                                     |
|--------------------------------------------------------|---------------------------------------------------------------------------------------------------------------------------------------------------------------------------------------------------------------------------------------------------------------------------------------------------------------------------------------------------------------------------------------------------------------------------------------------------------------------------------------------------------------------------------------------------------------------------------------------------------------------------------------------------------------------------------------------------------------------------------------------------------------------------------------------------------------------------------------------------------------------------------------------------------------------------------------------------------------------|
| (1) Select the menus [Prev surface] and [Next surface] |  <p>&lt;When the menu [Prev surface] is selected&gt;<br/>This will change the surface to the previous surface. (This will also display the surfaces for which no coordinate system has been set.)<br/>If there is no previous surface, the last surface is displayed.<br/>The feature coordinate origin and coordinate axial direction of the surface after switch are displayed.<br/>The cursor will move to X0 of feature coordinate origin.</p> <p>&lt;When the menu [Next surface] is selected&gt;<br/>This will change the surface to the next surface. (This will also display the surfaces for which no coordinate system has been set.) If there is no next surface, the first surface is displayed. The feature coordinate origin and coordinate axial direction of the surface after switch is displayed. The cursor will move to X0 of feature coordinate origin.</p> |

## 9.2.3.7 Rotating the Axial Direction of Coordinate Axis

The coordinate axes of the coordinate system defined on a machining surface can be rotated.

- When this operation is performed for the machining target surface (a surface along which three orthogonal coordinate axes are controlled at present), the error message "Can't set machining surface" is displayed.
- When the data protection is valid, entering or changing data is disabled on this screen. The message "Data protect" is displayed.
- When "Index angle" method is applied to Z axis and "Axial point (+)" to X/Y axes, and the set values of "Star point/ End point" are all "0.000", it is not possible to rotate X and Y by 90 degrees.

**Note**

- (1) When this operation is operated, the value of coordinate axial direction registered to NC and the value of coordinate axial direction displayed on the surface detail screen will be automatically changed.
- (2) When you reverse the Z axis direction twice, or rotate X/Y axes by 90 degrees four times, you restore the original axial directions, but a small deviation may result due to a calculation error.

The following two types of operation are possible

**Operation method (Reverse Z axis direction)**

While fixing the X axis direction, inversely rotate the Z and Y axes by 180 deg.

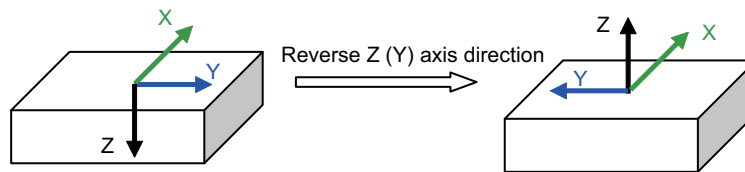

(1) Select the menu [Axial rotate].

(2) Select the menu [Z-axis reverse].

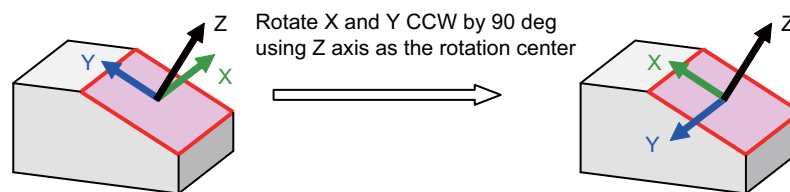

The Z (Y) axis direction of the feature coordinate defined on the machining surface will reverse.

**Operation method (Rotate X and Y CCW by 90 deg. (the center of rotation is Z axis))**

(1) Select the menu [Axial rotate].

(2) Select the menu [X/Y 90 rotate].



The X and Y coordinates of the feature coordinate defined on the machining surface will rotate 90 deg. counter-clockwise about Z axis

### 9.2.3.8 Default Settings of Designation Method and Axis Combination

Use the following parameters to specify the default settings of the axis direction designation method and the two-axis combination to be used for designating the direction. Specify the initial setting of the designation method with the parameter "#8954 Initial type". Specify the initial setting of the axis combination with the parameter "#8955 Init axis pair".

When any of the following operations is carried out, the values of #8944 and #8955 will be set as default values.

| Operation                                                            | The surface to which the parameter values are set                            |
|----------------------------------------------------------------------|------------------------------------------------------------------------------|
| When the workpiece size is set for the first time                    | All surfaces belonging to the work<br>(except for Surface #1 (BASE-SURFACE)) |
| When the workpiece size is set again after the workpiece is cleared. | All surfaces belonging to the work<br>(except for Surface #1 (BASE-SURFACE)) |
| When the surface is cleared.                                         | The cleared surface                                                          |

#### Note

- (1) When #8954 (Initial type) is set to 5 (Index angle), the "Index angle" method is applied to the Z axis direction. However, "Axial point (+)" is applied to the X and Y directions.
- (2) If you change the parameter #8944 or #8955 after setting the workpiece size, the designation method or axis combination will not change. To reflect the value of the parameter, reset the work size after clearing the workpiece or clear the surface.

9.2.4 Surface Selection



By selecting a machining surface, the commands programmed with three orthogonal axes can move the tool along the selected surface (feature coordinate system). This selected surface is called a machining target surface. This enables a program with three orthogonal axes to carry out multi-surface machining including inclined surface machining. Also, a tool can be set vertical to the machining target surface (indexing).

This function is an additional specification, and the machining surface can be selected for each part system.

**Note**

- (1) To select a machining surface, work and machining surface need to be registered beforehand on the surface setting screen of setup screen. For details, refer to "9.2 R-Navi".

**CAUTION**

Selected machining surface is not canceled even when NC reset is executed, the coordinate system defined along the machining target surface (feature coordinate system) remains selected.

It depends on the setting of the parameter "#1247 set19/bit2" (Inclined surface machining mode hold) to hold or cancel the selected machining surface at the emergency stop state. However, selected machining surface is not held when the power is turned OFF.

Press the menu [Surface cancel] to cancel the selected machining surface. The operating coordinate system will be back to the machine coordinate system by canceling the machining surface.

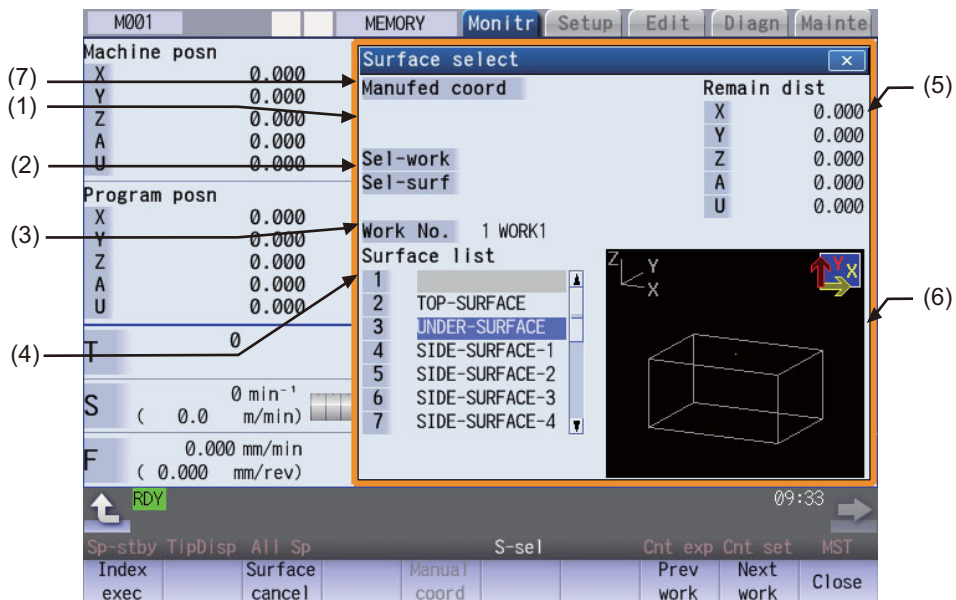

## Display items

| Display items                      | Description                                                                                                                                                                                                                                                                                                                                                                                                                                                                                                                                                                                                                                                                                                                                        |
|------------------------------------|----------------------------------------------------------------------------------------------------------------------------------------------------------------------------------------------------------------------------------------------------------------------------------------------------------------------------------------------------------------------------------------------------------------------------------------------------------------------------------------------------------------------------------------------------------------------------------------------------------------------------------------------------------------------------------------------------------------------------------------------------|
| (1) Index state                    | Displays the index state.<br>When "#11037 R-Navi Index Type" is "0", "Indexing" is displayed with flicker by selecting the menu [Index exec].<br>When "#11037 R-Navi Index Type" is "1", "Indexing" is displayed with flicker by selecting the menu [Index exec] and then entering the tool length offset number (H).                                                                                                                                                                                                                                                                                                                                                                                                                              |
| (2) Selected work/Selected surface | Displays the machining target surface and its work of the part system being displayed.                                                                                                                                                                                                                                                                                                                                                                                                                                                                                                                                                                                                                                                             |
| (3) Work No.                       | Displays the work No. that is displayed on the surface list.<br>The work can be switched by selecting the menus [Prev work] and [Next work].                                                                                                                                                                                                                                                                                                                                                                                                                                                                                                                                                                                                       |
| (4) Surface list                   | Displays the list of surfaces that are registered for the work displayed at Work No. If the machining target surface is included, it is displayed with an asterisk (*).                                                                                                                                                                                                                                                                                                                                                                                                                                                                                                                                                                            |
| (5) Remaining distance counter     | Displays the remaining distance up to the point where the tool is vertical to the machining target surface (indexing position).<br>When "#11037 R-Navi Index Type" is "0", remaining distance will be calculated automatically by pressing the menu [Index exec].<br>When "#11037 R-Navi Index Type" is "1", remaining distance will be calculated automatically by pressing the menu [Index exec] and then inputting the tool length compensation number.<br>The counters of five axes are displayed in the order specified by "#1494 dsp_ax_change".                                                                                                                                                                                             |
| (6) Workpiece graphic              | Displays the image of workpiece displayed at Work No. in 3D. It also displays with arrow marks, the surface pointed by the cursor in the list, and the directions of X, Y and Z axes of the coordinate system (feature coordinate system) registered for the surface. (X axis is in yellow, Y in red and Z in green)                                                                                                                                                                                                                                                                                                                                                                                                                               |
| (7) Manual feed coordinate system  | Displays the coordinate system along which manual feed is carried out while the machining target surface is being selected. The machine coordinate system and the feature coordinate system can be switched by the menu [Manual coord]. If the target surface is not selected it is displayed as blank. The initial coordinate values when a machining target surface is selected will be those of the feature coordinate system when the parameter "#8127 R-Navi Manufed coord" is "0", and when #8127 is "1" the initial values will be those of the machine coordinate system.<br><br><Note><br>♦The operation is performed along the feature coordinate system during automatic operation, regardless of the coordinate system displayed here. |

## Menus

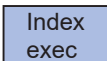
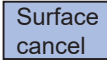
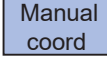
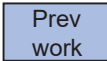
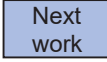
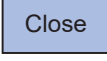
| Menus                                                                               | Description                                                                                                                                                                                                                                   |
|-------------------------------------------------------------------------------------|-----------------------------------------------------------------------------------------------------------------------------------------------------------------------------------------------------------------------------------------------|
|  | Executes indexing to the machining target surface.                                                                                                                                                                                            |
|  | Cancels the coordinate system (feature coordinate system) defined when a machining target surface is selected, and sets the current coordinate system as the machine coordinate system.                                                       |
|  | Switches the coordinate system along which manual feed is performed during the machining target surface selection between the machine coordinate system and feature coordinate system. This menu is valid only during surface selection. (*1) |
|  | Switches the work to display from the currently selected work to the previous work. If there is no previous workpiece, the last workpiece is displayed.                                                                                       |
|  | Switches the work to display from the currently selected work to the next work. If there is no next work, the first work is displayed.                                                                                                        |
|  | This closes the pop-up window.                                                                                                                                                                                                                |

(\*1) When the target surface is not selected, this menu is grayed out and cannot be selected.

## 9.2.4.1 Selecting a Machining Target Surface

Select a machining target surface. By selecting the machining surface, the commands programmed with three orthogonal axes can move the tool along the selected surface (feature coordinate system). This enables a program with three orthogonal axes to carry out multi-surface machining including inclined surface machining. Machining surface can be selected for each part system.

**CAUTION**

**Selected machining surface is not canceled even when NC reset is executed, the coordinate system defined along the machining target surface (feature coordinate system) remains selected.**

**It depends on the setting of the parameter "#1247 set19/bit2" (Inclined surface machining mode hold) to hold or cancel the selected machining surface at the emergency stop state. However, selected machining surface is not held when the power is turned OFF.**

**Press the menu [Surface cancel] to cancel the selected machining surface. The operating coordinate system will be back to the machine coordinate system by canceling the machining surface.**

**Operation method**

- (1) Move the cursor to the row of machining surface to be selected using arrow keys ([↑], [↓]).
- (2) Press the [INPUT] key.



An asterisk (\*) is placed in front of a surface name, indicating that the surface is the machining target surface. Also, the name of the selected work and its number, and the machining surface name and its number are displayed at Sel-work and Sel-surf. If coordinate system setting of machining surface is illegal, it cannot be selected. The message "Feat. coord setting error " is displayed.

**Note**

- (1) The machining target surface and its work will be canceled when the power is turned ON again.
- (2) This operation is disabled during automatic operation. The message "Executing automatic operation" is displayed.
- (3) This operation is disabled during surface indexing. The message "Indexing machined surface" is displayed.
- (4) This operation is disabled when rotary axis configuration parameter is illegal, surface selection is being processed (\*1), or surface cancel is being processed (\*2). The message "Machining surface cannot be selected" is displayed.
  - (\*1) "Surface selection is being processed" means the period from when machining surface selection is performed (the [INPUT] key is pressed) until when the machining target surface is actually selected and the selected work and surface are displayed.
  - (\*2) "Surface cancel is being processed" means the period from when machining surface cancel is performed (the menu [Surface cancel] is pressed) until the target surface is actually canceled and the display of the selected work and surface is canceled.
- (5) On MDI status "SEL" is displayed with flicker when a machining surface is selected. (Even under the MDI mode, "SEL" display is preferred during the surface selection.)
- (6) On the monitor screen of the 2-part system simultaneous display, "SEL" is not displayed with flicker on MDI status even if the part system that is under surface selection is displayed.
- (7) The graphic check or trace is carried out along the machine coordinate system while a machining target surface is being selected.

## 9.2.4.2 Indexing the Machining Target Surface

Given below is the procedure of indexing the currently selected machining surface (turning the tool to be perpendicular to the machining target surface). By setting the parameter "#11037 R-Navi Index Type", method can be selected from two types: moving the rotary axis only (type 1) and moving both rotary and orthogonal axes while fixing the tool tip at a position viewed from the workpiece (type 2).

**Operation method**

[Prepare indexing]  
<When #11037=0>

- (1) Select the menu [Index exec].



"Indexing" flickers and the machining target surface will be in the indexing state. The remaining distance necessary to complete indexing is displayed on the remaining distance counter.

<When #11037=1>

- (1) Select the menu [Index exec].



The menu [Index exec] will be highlighted, and the message "Set the tool length compensation No.(H)." is displayed.

- (2) Input the tool length compensation No. and select the [INPUT] key.



"Indexing" flickers and the machining target surface will be in the indexing state. The remaining distance necessary to complete indexing is displayed on the remaining distance counter.

[Execute indexing]

<For manual indexing>

Use a handle to do indexing.

- (1) Select the memory mode and select auto start button.



Operates automatic operation until the remaining distance counter becomes "0". Also, when the value of counter becomes "0", flickering "Indexing" will disappear.

<For manual indexing>

Use a handle to do indexing. This allows the operator to do indexing while observing the work and tool positions. It is also possible to switch to automatic indexing in the middle of the operation.

- (1) Select the rotary axis in the handle mode and turn the handle.



When the counter values reach all zero, flickering "Indexing" will disappear.



**Note**

- (1) This operation is disabled during automatic operation. The message "Executing automatic operation" is displayed.
- (2) The indexing will be canceled by NC reset operation.
- (3) This operation is disabled if no machining target surface is selected. The message "Machining surface not selected" is displayed.
- (4) This operation is disabled during surface indexing. The message "Indexing machined surface" is displayed.
- (5) This operation is disabled when surface selection is being processed (\*1), or when surface cancel is being processed (\*2). The message "Indexing not possible" is displayed.
  - (\*1) "Surface selection is being processed" means the period from when machining surface selection is performed (the [INPUT] key is pressed) until when the machining target surface is actually selected and the selected work and surface are displayed.
  - (\*2) "Surface cancel is being processed" means the period from when machining surface cancel is performed (the menu [Surface cancel] is pressed) until the target surface is actually canceled and the display of the selected work and surface is canceled.
- (6) When 3D machine interference check is valid, the manual indexing cannot be executed. The operation error (M01 0005) will occur if the indexing is executed.

## 9.2.4.3 Canceling the Machining Target Surface

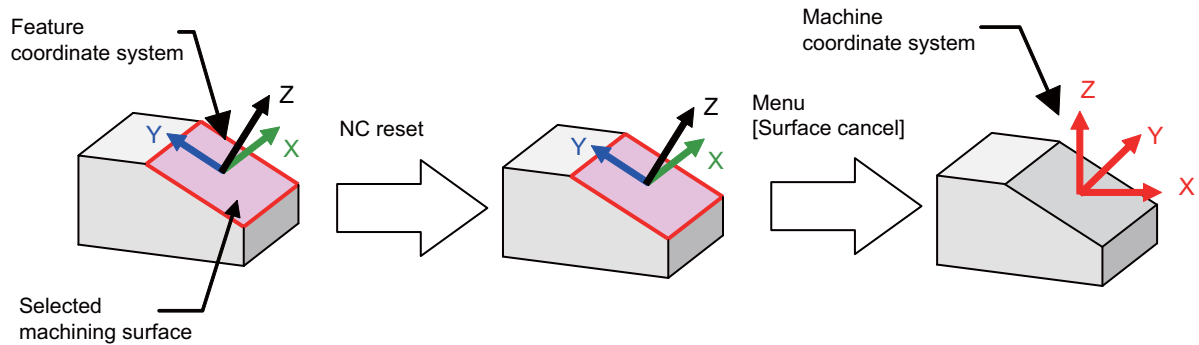
When a machining surface is selected, the coordinate system defined on the machining surface (feature coordinate system) remains selected even if NC reset is executed. This operation, however, switches the selected coordinate system back to the machine coordinate system.

**Operation method**

- (1) Select the menu [Surface cancel].  The menu [Surface cancel] will be highlighted, and the message "OK?(Y/N)" is displayed.  
To cancel the highlight, select the menu [Retn] or select the menu [Surface cancel] again.
- (2) Press the [Y] or [INPUT] key.  The selection of machining surface will be released.

**Note**

- (1) The "Executing automatic operation" error occurs during automatic operation, and canceling the surface is disabled.
- (2) This operation is disabled when surface selection is being processed (\*1), or when surface cancel is being processed (\*2). The message "Can't cancel" is displayed.
  - (\*1) "Surface selection is being processed" means the period from when machining surface selection is performed (the [INPUT] key is pressed) until when the machining target surface is actually selected and the selected work and surface are displayed.
  - (\*2) "Surface cancel is being processed" means the period from when machining surface cancel is performed (the [Surface cancel] key is pressed) until the target surface is actually canceled and the display of the selected work and surface is canceled.
- (3) The flickering "SEL" on the MDI status will be canceled.
- (4) This operation is disabled if no machining target surface is selected. The message "Machining surface not selected" is displayed.
- (5) This operation is disabled during surface indexing. The message "Indexing machined surface" is displayed.







#### 9.2.4.4 Switching the Machining Target Surface

When selecting the menu [Manual coord] during surface selection, the coordinate system along which manual feed is conducted can be switched between the machine coordinate system and feature coordinate system. The initial coordinate values when a machining target surface is selected will be those of the feature coordinate system when the parameter "#8127 R-Navi Manufed coord" is "0" , and when #8127 is "1" the initial values will be those of the machine coordinate system. However, operation is performed along the feature coordinate system during automatic operation, regardless of the coordinate system displayed here.

##### Operation method

Assume that the parameter "#8127 R-Navi Manufed coord" is set to "0" (feature coordinate system).

- |                                                      |                                                                                   |                                                                        |
|------------------------------------------------------|-----------------------------------------------------------------------------------|------------------------------------------------------------------------|
| (1) Select a machining target surface.               |  | The manual feed coordinate system becomes "feature coordinate system". |
| (2) Select the menu [Manual coord].                  |  | The manual feed coordinate system becomes "machine coordinate system". |
| (3) Cancel the surface by the menu [Surface cancel]. |  | The manual feed coordinate system becomes blank.                       |
| (4) Select a machining target surface.               |  | The manual feed coordinate system becomes "feature coordinate system". |

#### 9.2.4.5 Switching the Workpiece

Switch the work that is displayed on "Work No." to the other work. When work is switched, the cursor on the surface list will move to the surface "BASE-SURFACE".

##### Operation method (Select next work)

Switch the currently displayed work to the next work. If there is no next work, the first work is displayed.

- |                                  |                                                                                     |                                                    |
|----------------------------------|-------------------------------------------------------------------------------------|----------------------------------------------------|
| (1) Select the menu [Next work]. |  | The work switches to the next largest No. of work. |
|----------------------------------|-------------------------------------------------------------------------------------|----------------------------------------------------|

##### Operation method(Select previous work)

Switch the currently displayed work to the previous work. If there is no previous workpiece, the last workpiece is displayed.

- |                                      |                                                                                     |                                                     |
|--------------------------------------|-------------------------------------------------------------------------------------|-----------------------------------------------------|
| (1) Select the menu [Previous work]. |  | The work switches to the next smallest No. of work. |
|--------------------------------------|-------------------------------------------------------------------------------------|-----------------------------------------------------|

## 9.3 Integrated Time

### 9.3.1 Integrated Time Display



The integrated time (date, time, power ON time, automatic operation time, automatic start time, external integrated time 1, external integrated time 2, cycle time and cutting time) controlled by the NC can be set and displayed.

Note that the cycle time cannot be set.

The integrated times displayed in cycle time display area on the Monitor screen can be set.

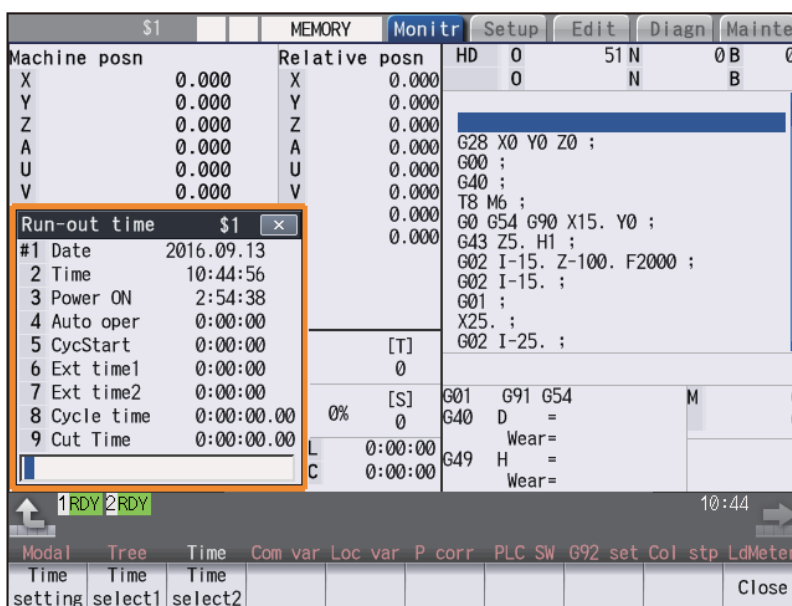

#### Display items

| Display items | Details                                                                                                                                                                                                                                                                                                                            |
|---------------|------------------------------------------------------------------------------------------------------------------------------------------------------------------------------------------------------------------------------------------------------------------------------------------------------------------------------------|
| #1 Date       | The current date set in the NC is displayed.<br>Year: 4 digits, Month: 2 digit, Date: 2 digit (YYYY.MM.DD)                                                                                                                                                                                                                         |
| 2 Time        | The current time set in the NC is displayed using the 24-hour system.<br>(HH:MM:SS)                                                                                                                                                                                                                                                |
| 3 Power ON    | This displays the total integrated time of the time from NC power ON to OFF.<br>(HHHH:MM:SS)                                                                                                                                                                                                                                       |
| 4 Auto oper   | This displays the total integrated time of the work time from automatic start button pressing in the memory (tape) mode or MDI to M02/M30 or reset button pressing.<br>(HHHH:MM:SS)                                                                                                                                                |
| 5 Auto strt   | This displays the total integrated time during automatic starting from automatic start button pressing in the memory (tape) mode or MDI to feed hold stop, block stop, or reset button pressing. (HHHH:MM:SS)                                                                                                                      |
| 6 Ext time 1  | This content differs depending on MTB specification. (HHHH:MM:SS)                                                                                                                                                                                                                                                                  |
| 7 Ext time 2  | This content differs depending on MTB specification. (HHHH:MM:SS)                                                                                                                                                                                                                                                                  |
| 8 Cycle time  | This displays the time that automatic operation is started from when the automatic start button is pressed in the memory (tape) mode or MDI to when feed hold stop or block stop is applied or the reset button is pressed.                                                                                                        |
| 9 Cut time    | This displays the total time of the cutting commands (a part of the group 1 modal commands (*1)) given in the memory (tape) mode or MDI mode, from when the cycle start button is pressed until a feed hold stop, block stop, or a press of the reset button. This time will be cleared to "0" by pressing the cycle start button. |
| Input section | This displays details of the key input.                                                                                                                                                                                                                                                                                            |

(\*1) The following table shows the group 1 modal commands, the times of which are added to the cut time.

|             |                                      |
|-------------|--------------------------------------|
| G01         | Linear interpolation                 |
| G02/G03     | Circular interpolation               |
| G02.1/G03.1 | Spiral/Conical interpolation         |
| G02.3/G03.3 | Exponential interpolation            |
| G02.4/G03.4 | 3-dimensional circular interpolation |
| G06.2       | NURBS interpolation                  |
| G33         | Thread cutting                       |
| G34         | Variable lead thread cutting         |
| G35/G36     | Circular thread cutting              |

The automatic return to the restart position when the program is restarted is not added to the cut time.

A travel command given during the direct command mode specification is added to the cut time.

### Note

(1) When the indicated value reaches the maximum, the items #3 Power ON to #9 Cut time stops adding, and the maximum value remains displayed.

<Maximum time>

•#3 Power ON to #7 Ext time 2: 59999:59:59



•#8 Cycle time to #9 Cut time: 7999:59:59.99

### Menus

| Menus        | Details                                                                           |
|--------------|-----------------------------------------------------------------------------------|
| Time setting | This sets the integrated time.                                                    |
| Time select1 | The time that is displayed in upper line on cycle time display area is selected.  |
| Time select2 | The time that is displayed in bottom line on cycle time display area is selected. |
| Close        | This closes the pop-up window and quits this function.                            |

### 9.3.2 Setting the Integrated Time



#### Operation method

- (1) Press the menu [Time setting].  The mode changes to the time setting mode. The cursor appears at the "#1 Date" position in the integrated time display.
- (2) Input today's date.  
(Example) 2015/4/1 [INPUT]  "2015.04.01" appears at "#1 Date", and the cursor moves to "#2 Time".
- (3) Set the data for each item, and press the [INPUT] key.  
If the item does not need to be set, press the [↓] key and move the cursor.  When "#7 External integrated time 2" has been set, the cursor disappears, and the time setting menu highlight is turned OFF.  
Note that "#8 Cycle time" and "#9 Cut time" cannot be set, so the cursor will not move.

**Note**

(1) The data delimiters are as shown below:

| Item                    | Valid delimiters during setting | Delimiters in display |
|-------------------------|---------------------------------|-----------------------|
| #1 Date                 | ". " or " / "                   | " . "                 |
| #2 Time to #7 Ext time2 | " : " or " / "                  | " : "                 |

(2) If the menu [Time setting],  or  key is pressed again during the time setting mode, the mode will be canceled.





**Setting range**

| Display items | Range                   |
|---------------|-------------------------|
| #1 Date       | 1980.1.1 to 2069.12.31  |
| 2 Time        | 00:00:00 to 23:59:59    |
| 3 Power ON    | 00:00:00 to 59999:59:59 |
| 4 Auto oper   |                         |
| 5 Auto strt   |                         |
| 6 Ext time 1  |                         |
| 7 Ext time 2  |                         |

## 9.3.3 Setting the Time Display Selection

The displayed time is set on cycle time display area.

**Operation method**

- |                                                                           |                                                                                     |                                                                                                                                               |
|---------------------------------------------------------------------------|-------------------------------------------------------------------------------------|-----------------------------------------------------------------------------------------------------------------------------------------------|
| (1) Press the menu "Time select1".                                        |  | The time selection mode is activated.                                                                                                         |
| (2) Press the time type for the mode to display.<br>(Example) [Auto oper] |  | The automatic operation time is displayed in upper line on cycle time display area.<br>The menu display returns to integrated time sub-menu.  |
| (3) Press the menu "Time select2".                                        |  | The time selection mode is activated.                                                                                                         |
| (4) Press the time type for the mode to display.<br>(Example) [Power ON]  |  | The automatic operation time is displayed in bottom line on cycle time display area.<br>The menu display returns to integrated time sub-menu. |

**Note**

- (1) The displayed time is held even after the power is turned OFF and ON.
- (2) The displayed time is common for part systems.
- (3) The minimum unit for the cycle time and the cutting time is second.

## 9.4 Counter Setting

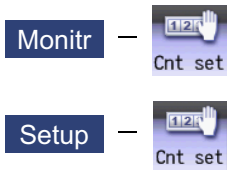

An arbitrary value can be set in the relative position counter which opens as a pop-up window. The counter cannot be set for an axis of auxiliary axis state. It also can be set on the setup (Setup) screen.

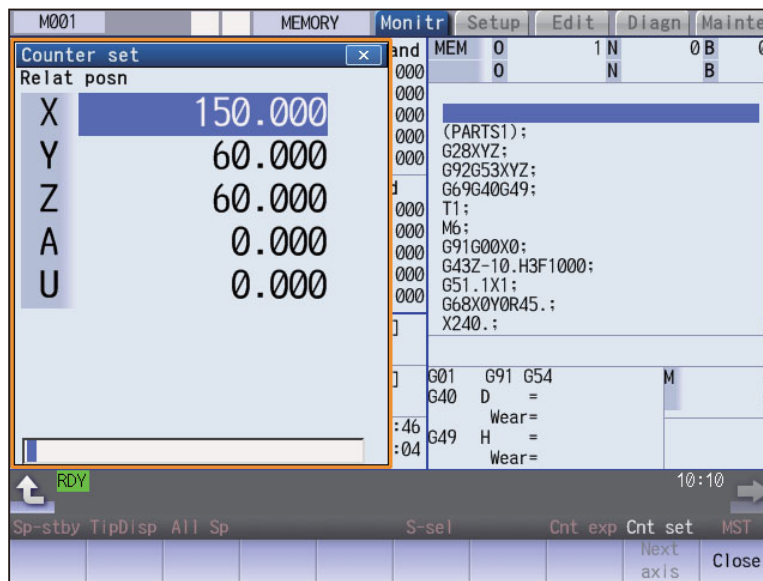

### Menus

| Menus     | Details                                                                                                                                                                                                                                                                                                                                                                                                                                                                                                                  |
|-----------|--------------------------------------------------------------------------------------------------------------------------------------------------------------------------------------------------------------------------------------------------------------------------------------------------------------------------------------------------------------------------------------------------------------------------------------------------------------------------------------------------------------------------|
| Close     | This closes the pop-up window and quits this function.                                                                                                                                                                                                                                                                                                                                                                                                                                                                   |
| Next axis | <p>This switches the axis to be displayed on the counter.</p> <p>&lt;Note&gt;</p> <ul style="list-style-type: none"> <li>♦This menu is grayed out and non-selectable in the following cases:                             <ul style="list-style-type: none"> <li>- The number of enabled axes is 8 or less.</li> <li>- The number of enabled axes is 9 or more, however, the number of displayed axes is 8 or less according to the parameter "#1069 no_dsp Axis with no counter display" setting.</li> </ul> </li> </ul> |

### Operation method

- (1) Press the main menu [Counter set]. → The relative position counter opens as a pop-up window. The cursor appears at the 1st axis of the relative position counter.

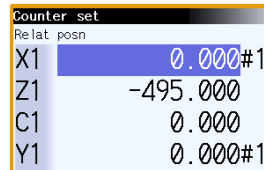

- Instead of the operation above, the axis name address key can be pressed to set the counter. (Example) [Z] → The relative position counter opens as a pop-up window. The cursor appears at the designated axis (Z axis).

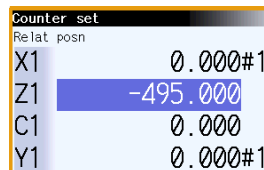

- (2) Using the [↑], [↓], or the axis name address key, move the cursor to the axis to be set. → The cursor moves.

<Note>

- If two axes or more of the same name exist such as mixed control (cross axis control), the cursor moves to the axis corresponding to the address key to the axis name input first.

- (3) Input a numeric value. (Example) 100.000 [INPUT] → The set value "100.000" appears at the cursor position. The cursor moves to the next axis.  
If the [INPUT] key is pressed without inputting a value, zero (0) will be set.

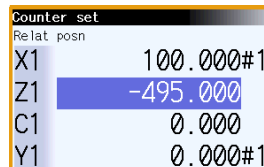

- (4) Repeat step (3) for each axis. For axes that are not to be operated, press the [↓] key and move the cursor. → The pop-up window closes when the counter has been set for the last axis.

### Note

- (1) When an address such as "S", "M", "T" or "B" is used for the first character of axis name of the parameter "#1022 ax-name2", not the MSTB window but the Counter set window is displayed for address key input.

## 9.5 Origin Set, Origin Cancel



Origin set and origin cancel can be executed.

Origin set and origin cancel cannot be executed for an axis of auxiliary axis state.

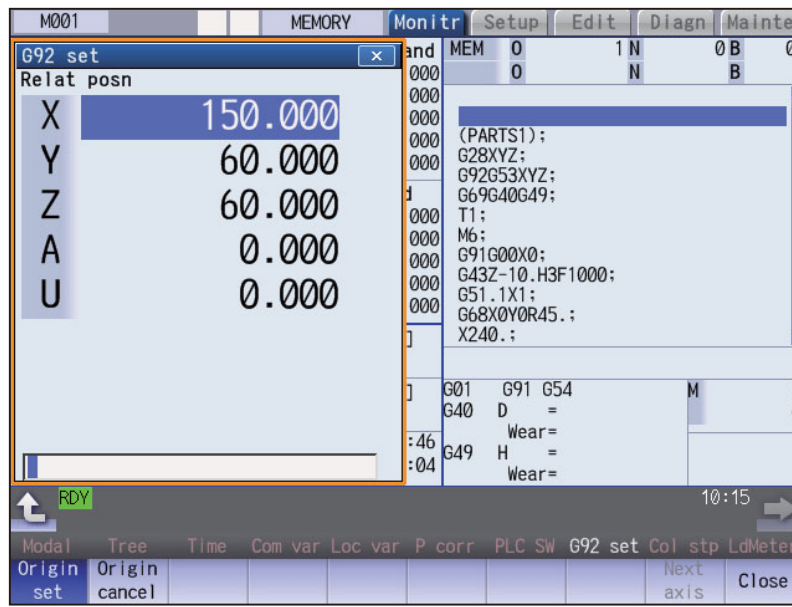

### Menus

| Menus         | Details                                                                                                                                                                                                                                                                                                                                                                                                                                                                                                         |
|---------------|-----------------------------------------------------------------------------------------------------------------------------------------------------------------------------------------------------------------------------------------------------------------------------------------------------------------------------------------------------------------------------------------------------------------------------------------------------------------------------------------------------------------|
| Origin set    | The origin is set.<br>When main menu [G92 set] is pressed, the menu [Origin set] is highlighted and the origin set mode is activated.                                                                                                                                                                                                                                                                                                                                                                           |
| Origin cancel | The origin is canceled.<br>The origin cancel mode is activated when this menu is pressed.                                                                                                                                                                                                                                                                                                                                                                                                                       |
| Next axis     | This switches the axis to be displayed on the counter.<br><br><Note><br><ul style="list-style-type: none"> <li>◆ This menu is grayed out and non-selectable in the following cases:                             <ul style="list-style-type: none"> <li>- The number of enabled axes is 8 or less.</li> <li>- The number of enabled axes is 9 or more, however, the number of displayed axes is 8 or less according to the parameter "#1069 no_dsp Axis with no counter display" setting.</li> </ul> </li> </ul> |
| Close         | This closes the pop-up window and quits this function.                                                                                                                                                                                                                                                                                                                                                                                                                                                          |

## Differences between origin set and origin cancel

|                                     | Origin set                                                                                                                                                                                      | Origin cancel                                                                                                                                                                                                               |
|-------------------------------------|-------------------------------------------------------------------------------------------------------------------------------------------------------------------------------------------------|-----------------------------------------------------------------------------------------------------------------------------------------------------------------------------------------------------------------------------|
| <b>Function</b>                     | The coordinate system is shifted so the current position becomes the designated position of the workpiece coordinate system.<br>This is equivalent to "G92 X0".<br>(When X is the target axis.) | The coordinate system is shifted so the zero point of the workpiece coordinate system matches the zero point of the basic machine coordinate system.<br>This is equivalent to "G92 G53 X0".<br>(When X is the target axis.) |
| <b>Changes in the counter value</b> | The relative position counter and workpiece coordinate counters become "0".                                                                                                                     | The relative position counter matches the machine coordinate counter.                                                                                                                                                       |
| <b>Offset</b>                       | The G92 shift amount is updated.                                                                                                                                                                | The G92 shift amount and the G52 shift amount for the G54 to G59 coordinate system becomes "0".                                                                                                                             |

## Operation method (Setting the origin)

- (1) Press the main menu [G92 set].



The relative position counter opens as a pop-up window. The menu [Origin set] is highlighted. The cursor appears at the 1st axis of the relative position counter.

| G92 set     |           |
|-------------|-----------|
| Relat. posn |           |
| X1          | 100.000#1 |
| Z1          | -495.000  |
| C1          | 0.000     |
| Y1          | 0.000#1   |

- (2) Using the [↑], [↓], or the axis name address key, move the cursor to the axis to be set.



The cursor moves.

<Note>

- If two axes or more of the same name exist such as mixed control (cross axis control), the cursor moves to the axis corresponding to the address key to the axis name input first.

- (3) Input 0, and then press the [INPUT] key. If the [INPUT] key is pressed without inputting a value, zero (0) will be set. (Origin zero)



"0.000" appears at the cursor position. The cursor moves to the next axis.

| G92 set     |          |
|-------------|----------|
| Relat. posn |          |
| X1          | 0.000#1  |
| Z1          | -495.000 |
| C1          | 0.000    |
| Y1          | 0.000#1  |

- (4) Repeat step (3) for each axis. For axes that are not to be operated, press the [↓] key and move the cursor.



The pop-up window closes when the origin has been set for the last axis.

### Note

- (1) An error will occur if a value other than 0 is set.



**Operation method (Canceling the origin)**

- |                                                                                                                 |   |                                                                                                                                                                       |
|-----------------------------------------------------------------------------------------------------------------|---|-----------------------------------------------------------------------------------------------------------------------------------------------------------------------|
| (1) Press the main menu [G92 set], and then press the menu [Origin cancel].                                     | ➔ | The relative position counter opens as a pop-up window. The menu [Origin cancel] is highlighted. The cursor appears at the 1st axis of the relative position counter. |
| (2) Press the [INPUT] key.                                                                                      | ➔ | The same value as the machine position appears at the cursor position. The cursor moves to the next axis.                                                             |
| (3) Repeat step (2) for each axis. For axes that are not to be operated, press the [↓] key and move the cursor. | ➔ | The pop-up window closes when the origin has been canceled for the last axis.                                                                                         |

## 9.6 Manual Numerical Value Command

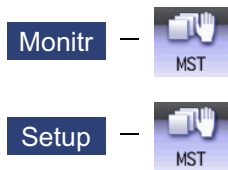

The spindle function (S), miscellaneous function (M), tool function (T) and 2nd miscellaneous function (B) commands can be executed.

The manual numerical value command can be executed by inputting an address such as S, M, T or B, as well. It also can be commanded on the setup (Setup) screen.

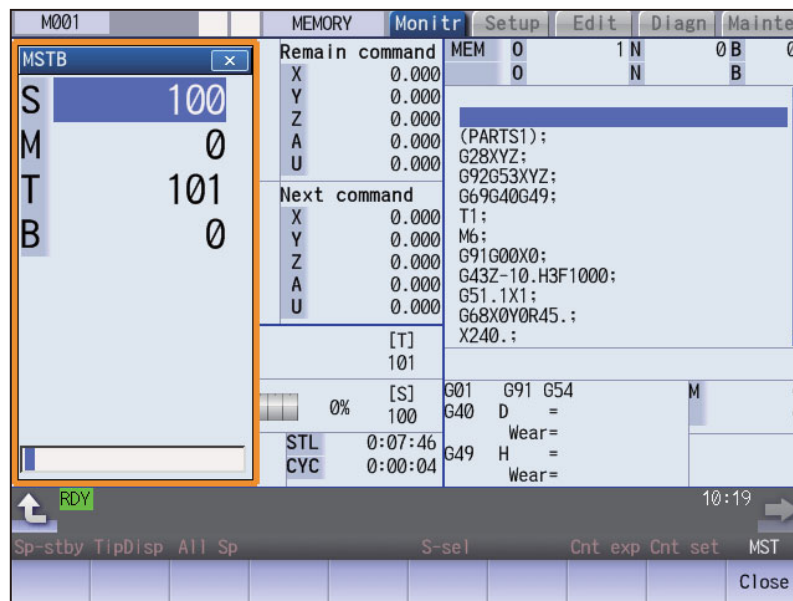

### Display items

| Display items                                         | Details                                                                                                                                                                                                                                                                                                                                                                                                                                     |
|-------------------------------------------------------|---------------------------------------------------------------------------------------------------------------------------------------------------------------------------------------------------------------------------------------------------------------------------------------------------------------------------------------------------------------------------------------------------------------------------------------------|
| S (spindle function) command value                    | The command value of S (spindle rotation command value) is displayed.<br>The number of displays varies depending on the value of the parameter "#1039 spinno" (Number of spindles).<br>However, if the value of the parameter "#1300 ext36/bit0" (Multiple-spindle control) is set to "1" (Multiple-spindle control II), the number of displays is set to "1" regardless of the value of the parameter "#1039 spinno" (Number of spindles). |
| M (miscellaneous function) command value              | The command value of M (miscellaneous function command value) is displayed.<br>The number of displays is set to "1" regardless of the value of the parameter "#12005 Mfig" (M count).                                                                                                                                                                                                                                                       |
| T (Tool function) command value                       | The command value of T (Tool function command value) is displayed.<br>The number of displays is set to "1" regardless of the value of the parameter "#12009 Tfig" (T count).<br>Only the tool number is displayed regardless of the value of the parameter "#11038 T disp type".                                                                                                                                                            |
| B (second (2nd) miscellaneous function) command value | The command value of B (second (2nd) miscellaneous function command value) is displayed.<br>The number of displays is set to "1" regardless of the value of the parameter "#12011 Bfig" (B count).<br>However, the value is displayed or hidden depending on the value of the parameter ("#1170 M2name" (2nd miscellaneous code)).                                                                                                          |

**Note**

- (1) If the number of spindles is 5 or less, the scroll bar is not displayed.

**Menus**

| Menus                                                                             | Details                                                |
|-----------------------------------------------------------------------------------|--------------------------------------------------------|
|  | This closes the pop-up window and quits this function. |

**Operation method (Executing T31 with a manual numerical value command)**

- (1) Press the main menu [MST].  The S, M, T, B display opens as a pop-up window.

|   |      |
|---|------|
| S | 100  |
| M | 50   |
| T | 4    |
| B | 1000 |

Using the [↑] or [↓] key, move the cursor to the setting position.  The cursor moves.

- (2) The manual numerical value command can also be issued by using the address keys instead of the operation above.  The S, M, T, B display opens as a pop-up window. The cursor appears at T.  
(Example) [T]

|   |      |
|---|------|
| S | 100  |
| M | 50   |
| T | 4    |
| B | 1000 |

- (3) Input a numeric value.  
31 [INPUT]  The input value is set.

**Note**

- (1) The cursor moves to the first line when the part system is changed while displaying the manual numeric command window.

**Operation method (Canceling the manual numerical value command)**

The manual numerical value command mode is canceled by carrying out one of the following operations before pressing the [INPUT] key.

- Press the menu [Close].
- Press the  key.
- Change the screen.

## 9.7 MDI Program Editing



Press the main menu [MDI] to display the contents of the MDI program in a pop-up window. When the parameter "#1144 mdlkof" is "0" (MDI setting impossible), switch to the MDI mode once to press the menu [MDI]. For details on editing of MDI program, refer to "3.6 Editing Operations" and the following descriptions.

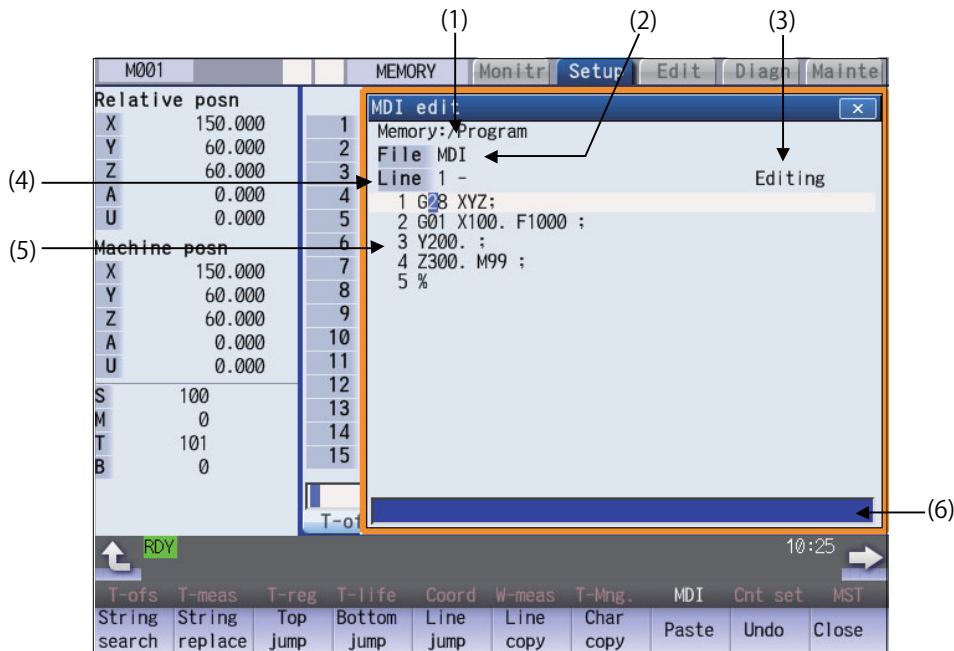

### Display items

| Display items                         | Details                                                                                                                                                                                                                           |
|---------------------------------------|-----------------------------------------------------------------------------------------------------------------------------------------------------------------------------------------------------------------------------------|
| (1) Path display                      | The path of the currently opened program file (memory:/program) is displayed.                                                                                                                                                     |
| (2) File name display                 | This displays the file name of the program currently being edited (MDI).                                                                                                                                                          |
| (3) Status                            | <Current edit display "Editing"><br>Displayed when the program is edited after it was displayed.<br>< Insert mode display><br>"INS" appears when the mode is switched to overwrite mode by pressing the [INSERT] key.             |
| (4) Top line of the displayed program | The No. of the top line of the program is displayed.                                                                                                                                                                              |
| (5) Line number                       | <Line number><br>This displays the last 3 digits of the program line number.<br>When over two or more lines are displayed on the screen because one line is long, the line No. does not attach to the beginning of the next line. |
| Program display                       | <Program display><br>This displays the contents of the MDI program currently being edited.                                                                                                                                        |
| (6) Input section                     | This displays details of the key input.                                                                                                                                                                                           |

| Menus          |                                                                                                                                                                                                                            |
|----------------|----------------------------------------------------------------------------------------------------------------------------------------------------------------------------------------------------------------------------|
| Menus          | Details                                                                                                                                                                                                                    |
| String search  | When the character string is designated and the [INPUT] key is pressed, that character string is searched for.                                                                                                             |
| String replace | If the character string to be searched for and the character string to be replaced are separated with a "/" and designated, when the [INPUT] key is pressed, the character string is replaced.                             |
| Top jump       | The program data from the top line is displayed on the screen. The cursor moves to the left side of the top line.                                                                                                          |
| Bottom jump    | The program data from the last line is displayed on the screen. The cursor moves to the left side of the last line.                                                                                                        |
| Line jump      | When the line number is set and the [INPUT] key is pressed, the program data for the set number and later is displayed on the screen. The cursor moves to the No. of designated line.                                      |
| Line copy      | This copies the designated line (multiple lines can be copied.)                                                                                                                                                            |
| Char copy      | This copies the character string designated by the cursor (multiple lines can be copied.)                                                                                                                                  |
| Paste          | This inserts the most recently copied contents to the line before the cursor or the position before the cursor.                                                                                                            |
| Undo           | This menu cannot be selected when parameter "#8910 Edit undo" is set to "0".<br><Note><br>♦When the parameter "#8939 Undo confirm msg" is set to "1", the menu is highlighted while the confirmation message is displayed. |
| Close          | This closes the pop-up window and quits this function.                                                                                                                                                                     |
| Line clear     | This erases the designated line (multiple lines can be erased).                                                                                                                                                            |
| Miss warning   | This displays the input mistake warning for MDI program being edited.                                                                                                                                                      |
| Next miss      | This moves the cursor to the next input mistake warning location.                                                                                                                                                          |
| Upward Tsearch | These menus search for T code upward or downward.                                                                                                                                                                          |
| Down Tsearch   |                                                                                                                                                                                                                            |

## Sub menus of [String search]

When the parameter "#19710 Edit-Upward search" is set to "1", the sub menus are displayed.

| Menus         | Details                                      |
|---------------|----------------------------------------------|
| Upward search | This switches the search direction upward.   |
| Down search   | This switches the search direction downward. |
| Quit search   | This finishes the string search.             |

### 9.8 PLC Switch



The various control signals for NC operation can be switched ON and OFF.  
 Refer to the instruction manual issued by the MTB for details.  
 The following screen is an example.

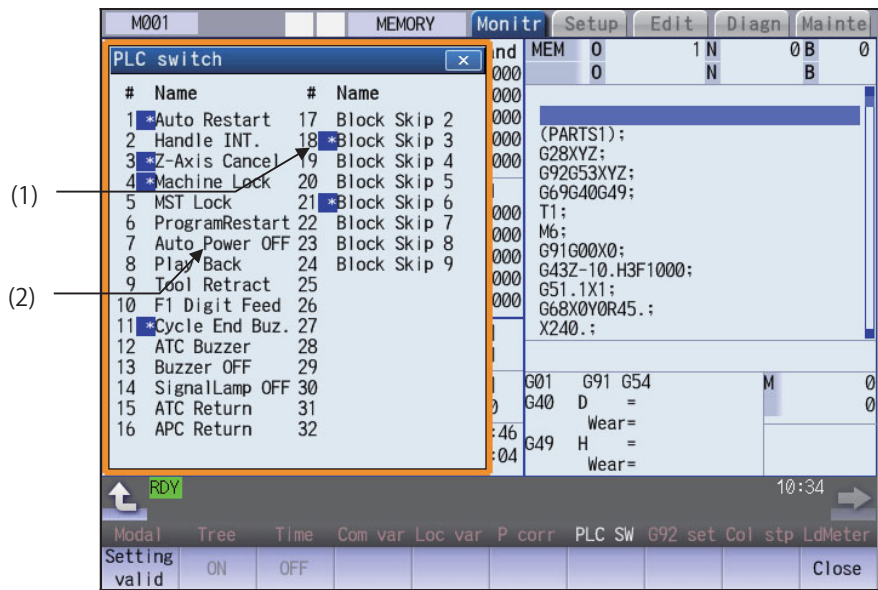

**Display items**

| Display items                 | Description                                                 |
|-------------------------------|-------------------------------------------------------------|
| (1) Mark indicating switch ON | This is displayed for switches that are turned ON           |
| (2) Switch name               | The display contents differ depending on MTB specification. |



**Menus**

| Menus         | Description                                                                                                                                                                                                      |
|---------------|------------------------------------------------------------------------------------------------------------------------------------------------------------------------------------------------------------------|
| Setting valid | Setting of the PLC switch is started.<br>When the parameter "#8974 Simple PLC switch" is valid, this menu will be disabled.                                                                                      |
| ON            | This turns ON the switch currently indicated by the cursor. (*1)                                                                                                                                                 |
| OFF           | This turns OFF the switch currently indicated by the cursor. (*1)                                                                                                                                                |
| Move window   | This moves the display position of the PLC switch window.<br>For the display unit other than 8.4- or 10.4-type, or when the parameter "#11019 2-system display" is set to nonzero, this menu cannot be selected. |
| Close         | This closes the pop-up window and quits this function.                                                                                                                                                           |

(\*1) In the state that the PLC switch cannot be set, the menu is grayed out and made unselectable.  
 Also, when the cursor is at the PLC switch which cannot be set, the menu is grayed out and made unselectable.  
 Which PLC switch cannot be set is determined by each MTB.

9.8.1 Turning PLC Switches ON/OFF

**Operation method (To turn switch "#6 ProgramRestart" ON)**

- (1) Press the menu [Setting valid].  The menu Setting valid will be highlighted. The message "Set up parameter?(Y/N)" is displayed. Whenever the parameter "#8974 Simple PLC switch" is valid, the parameter setting will be enabled.
- (2) Press the [Y] or [INPUT] key.  The PLC switch setting mode will be entered. The cursor will appear at the PLC switch No. position. The menus [ON] and [OFF] will appear normally.
- (3) Press the cursor keys [↑] and [↓] to move the cursor to "#6".  The #6 number is highlighted.





| # | Name           |
|---|----------------|
| 1 | Auto Restart   |
| 2 | Handle INT.    |
| 3 | Z-Axis Cancel  |
| 4 | Machine Lock   |
| 5 | MST Lock       |
| 6 | ProgramRestart |
| 7 | Auto Power OFF |
| 8 | Play Back      |

- (4) Press the menu [ON].  The "#6 ProgramRestart" switch turns ON, and a [\*] mark appears.  
To turn OFF, press the menu key OFF.

| # | Name            |
|---|-----------------|
| 1 | Auto Restart    |
| 2 | Handle INT.     |
| 3 | Z-Axis Cancel   |
| 4 | Machine Lock    |
| 5 | MST Lock        |
| 6 | *ProgramRestart |
| 7 | Auto Power OFF  |
| 8 | Play Back       |

"\*" mark appears.

**Note**

- (1) If the menu [Setting valid],  or  key is pressed again during the PLC switch setting mode, the mode will be canceled.
- (2) The PLC switch setting mode is canceled when the PLC switch's pop-up window is closed.
- (3) The cursor will not appear in modes other than the PLC switch setting mode.
- (4) When the number of the switch is 64, the display range of the number can be switched between "# 1 to # 32" and "# 33 to # 64" by pressing the  or  key.

## 9.9 Thread Recutting Function



This function stores the thread groove position to enable thread re-machining.

Using this function allows the tool to pass through the machined thread groove by storing the lead axis machine position and the spindle angle to fit the groove position of the re-chucked workpiece.

This function is an additional specification.

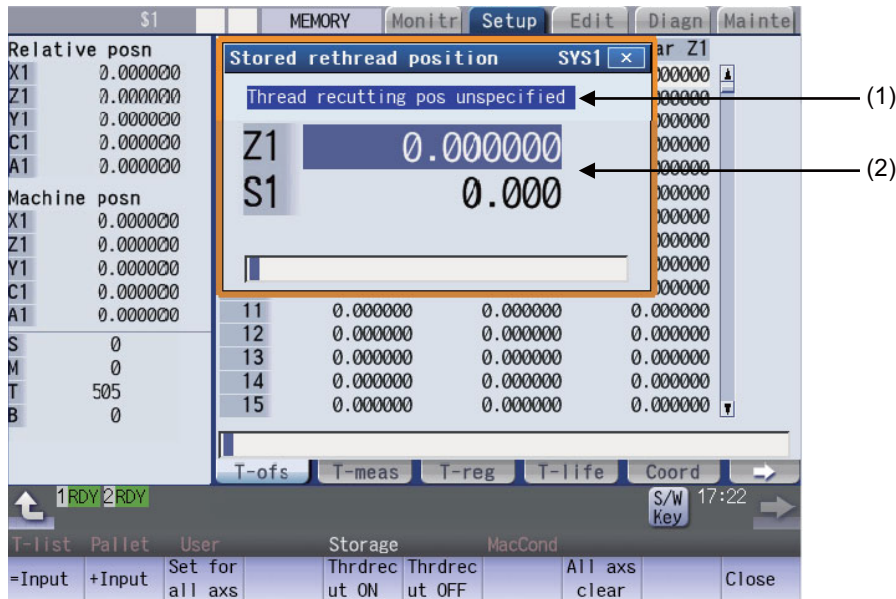

### Display items

| Display items                     | Details                                                                                                                                                                                                                                                                                                                                                                                                                                                                                                                                                                                                                                                                                                                                                                                                                                                                                                                                                        |        |                                                                                                               |                                  |                                                                                                                                                                    |                                |                                                                                                                                                                                                                                                                              |                     |                                                                                                                                                 |
|-----------------------------------|----------------------------------------------------------------------------------------------------------------------------------------------------------------------------------------------------------------------------------------------------------------------------------------------------------------------------------------------------------------------------------------------------------------------------------------------------------------------------------------------------------------------------------------------------------------------------------------------------------------------------------------------------------------------------------------------------------------------------------------------------------------------------------------------------------------------------------------------------------------------------------------------------------------------------------------------------------------|--------|---------------------------------------------------------------------------------------------------------------|----------------------------------|--------------------------------------------------------------------------------------------------------------------------------------------------------------------|--------------------------------|------------------------------------------------------------------------------------------------------------------------------------------------------------------------------------------------------------------------------------------------------------------------------|---------------------|-------------------------------------------------------------------------------------------------------------------------------------------------|
| (1) Thread recutting status       | <p>Displays the status to suit the thread recutting machining status.</p> <table border="1"> <thead> <tr> <th>Status</th> <th>Details</th> </tr> </thead> <tbody> <tr> <td>Thread recutting pos unspecified</td> <td>Displays the status in which the thread recutting position is not stored. When the menu [Thrdrecut ON] is pressed in this status, thread recutting is not enabled.</td> </tr> <tr> <td>Thread recutting pos specified</td> <td>Displays the status in which the thread recutting position is stored. When the menu [Thrdrecut ON] is pressed under this status, thread recutting is enabled. If thread cutting is commanded before the menu [Thrdrecut ON] is pressed, thread recutting is not carried out.</td> </tr> <tr> <td>In thread recutting</td> <td>Displays the status in which thread recutting is possible. When thread cutting is commanded under this status, thread recutting is carried out.</td> </tr> </tbody> </table> | Status | Details                                                                                                       | Thread recutting pos unspecified | Displays the status in which the thread recutting position is not stored. When the menu [Thrdrecut ON] is pressed in this status, thread recutting is not enabled. | Thread recutting pos specified | Displays the status in which the thread recutting position is stored. When the menu [Thrdrecut ON] is pressed under this status, thread recutting is enabled. If thread cutting is commanded before the menu [Thrdrecut ON] is pressed, thread recutting is not carried out. | In thread recutting | Displays the status in which thread recutting is possible. When thread cutting is commanded under this status, thread recutting is carried out. |
| Status                            | Details                                                                                                                                                                                                                                                                                                                                                                                                                                                                                                                                                                                                                                                                                                                                                                                                                                                                                                                                                        |        |                                                                                                               |                                  |                                                                                                                                                                    |                                |                                                                                                                                                                                                                                                                              |                     |                                                                                                                                                 |
| Thread recutting pos unspecified  | Displays the status in which the thread recutting position is not stored. When the menu [Thrdrecut ON] is pressed in this status, thread recutting is not enabled.                                                                                                                                                                                                                                                                                                                                                                                                                                                                                                                                                                                                                                                                                                                                                                                             |        |                                                                                                               |                                  |                                                                                                                                                                    |                                |                                                                                                                                                                                                                                                                              |                     |                                                                                                                                                 |
| Thread recutting pos specified    | Displays the status in which the thread recutting position is stored. When the menu [Thrdrecut ON] is pressed under this status, thread recutting is enabled. If thread cutting is commanded before the menu [Thrdrecut ON] is pressed, thread recutting is not carried out.                                                                                                                                                                                                                                                                                                                                                                                                                                                                                                                                                                                                                                                                                   |        |                                                                                                               |                                  |                                                                                                                                                                    |                                |                                                                                                                                                                                                                                                                              |                     |                                                                                                                                                 |
| In thread recutting               | Displays the status in which thread recutting is possible. When thread cutting is commanded under this status, thread recutting is carried out.                                                                                                                                                                                                                                                                                                                                                                                                                                                                                                                                                                                                                                                                                                                                                                                                                |        |                                                                                                               |                                  |                                                                                                                                                                    |                                |                                                                                                                                                                                                                                                                              |                     |                                                                                                                                                 |
| (2) Stored thread groove position | <p>Displays the currently stored thread groove position. When the power is turned ON, "0" is displayed. Once the thread groove position is stored, it is held until the power is turned OFF or data is cleared.</p> <table border="1"> <tbody> <tr> <td>Z1</td> <td>Lead axis machine position<br/>The target axis follows the setting of the parameter "#8714 Thrdrecut lead ax".</td> </tr> <tr> <td>S1</td> <td>Spindle angle<br/>The target spindle follows the setting of the parameter "#8715 Thread recut SP#".</td> </tr> </tbody> </table>                                                                                                                                                                                                                                                                                                                                                                                                            | Z1     | Lead axis machine position<br>The target axis follows the setting of the parameter "#8714 Thrdrecut lead ax". | S1                               | Spindle angle<br>The target spindle follows the setting of the parameter "#8715 Thread recut SP#".                                                                 |                                |                                                                                                                                                                                                                                                                              |                     |                                                                                                                                                 |
| Z1                                | Lead axis machine position<br>The target axis follows the setting of the parameter "#8714 Thrdrecut lead ax".                                                                                                                                                                                                                                                                                                                                                                                                                                                                                                                                                                                                                                                                                                                                                                                                                                                  |        |                                                                                                               |                                  |                                                                                                                                                                    |                                |                                                                                                                                                                                                                                                                              |                     |                                                                                                                                                 |
| S1                                | Spindle angle<br>The target spindle follows the setting of the parameter "#8715 Thread recut SP#".                                                                                                                                                                                                                                                                                                                                                                                                                                                                                                                                                                                                                                                                                                                                                                                                                                                             |        |                                                                                                               |                                  |                                                                                                                                                                    |                                |                                                                                                                                                                                                                                                                              |                     |                                                                                                                                                 |



## Menus

| Menus              | Details                                                                                                                                                                                                                                                                                           |
|--------------------|---------------------------------------------------------------------------------------------------------------------------------------------------------------------------------------------------------------------------------------------------------------------------------------------------|
| =Input             | This executes an absolute input.                                                                                                                                                                                                                                                                  |
| +Input             | This executes an incremental input.                                                                                                                                                                                                                                                               |
| Set for<br>all axs | Press this menu to automatically input the lead machine position or spindle angle in the stored rethread position window and store data.                                                                                                                                                          |
| Thrdrec<br>ut ON   | This changes the status to "In thread recutting", enabling thread recutting using the stored data. If this menu is not pressed, thread recutting is not carried out. If this menu is pressed while thread recutting is disabled, the message "Thread recut position is unspecified" is displayed. |
| Thrdrec<br>ut OFF  | This changes the thread recutting status from "In thread recutting" to "Re-thread position specified", disabling thread recutting.                                                                                                                                                                |
| All axs<br>clear   | This erases all data of the stored positions.                                                                                                                                                                                                                                                     |
| Close              | This closes the pop-up window.                                                                                                                                                                                                                                                                    |

9.9.1 Storing the Thread Groove Position

**Operation method**

Two methods are available to store the thread groove position: manual input and automatic input.

<Storing the thread groove position via manual input>

(1) Using the [↑] or [↓] key, switch the lead axis machine position (Z1) and the spindle angle (S1). → The cursor appears at the lead axis machine position (Z1) or the spindle angle (S1).

(2) Input the value in the item indicated by the cursor. → The input value is displayed in the input area.  
 Z1: Lead axis machine position  
 S1: Spindle angle

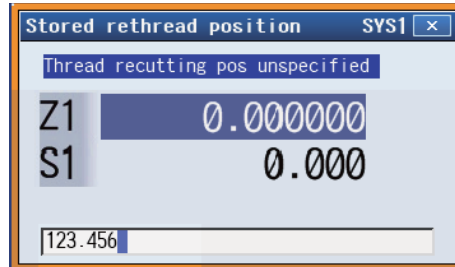

(3) Press the [INPUT] key or the menu [=Input].

<Note>

- It is possible to perform incremental input by pressing the menu [+Input] key instead of the [INPUT] key or the menu [=Input].  
 (Example) If the original data is 200:  
 250 + [+Input] -> 200 + 250 = 450

The input value is displayed in the input area. The value is stored at the position indicated by the cursor, and the cursor then moves down. However, if the cursor is at the spindle angle (S1), press the [INPUT] key to move the cursor to the lead axis machine position (Z1).

<Storing the thread groove position via automatic input>

(1) Manually move the nose of the thread cutting tool to the thread recutting groove.

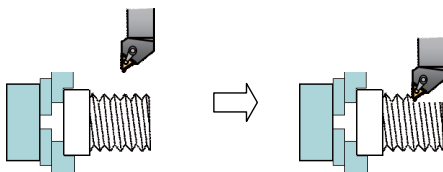

(2) Press the menu [Set for all axs].

→ The thread cutting status is changed to "Thread recutting pos specified", and the current lead axis machine position (Z1) and spindle angle (S1) are stored collectively.

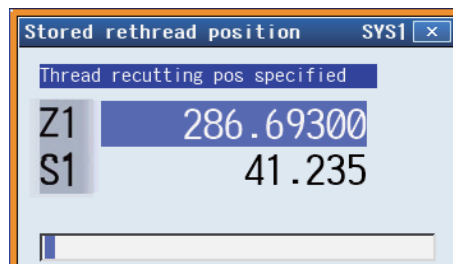

## 9.9.2 Switching the Stored Thread Groove ON/OFF

## Operation method

- (1) Press the menu [Thrdrecut ON] in the state "Thread recutting pos specified". → The thread cutting status is changed to "In thread recutting". In this state, retract the tool and start the thread recutting program to enable the same thread machining as that carried out for the original thread.

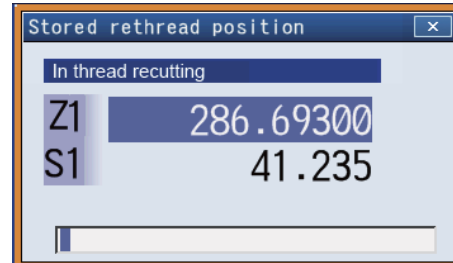

- (2) Press the menu [Thrdrecut OFF] in the state "In thread recutting". → The thread recutting status returns to the "Thread recutting pos specified" status, and thread recutting is disabled.

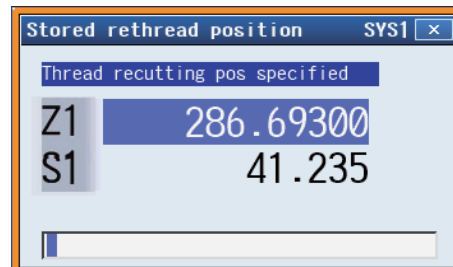

## 9.9.3 Erasing the Stored Thread Groove Position

## Operation method

- (1) Press the menu [All axis clear]. → The menu [All axis clear] is highlighted. A message displays confirming whether it is okay to erase the data.
- (2) Press the [Y] or [INPUT] key. → The lead axis machine position (Z1) or the spindle angle (S1) is cleared to "0".

## 9.10 Email Notification Function to Operator



This function enables NC to transmit emails to network-connected email servers (SMTP servers). The transmitted emails can be received by means of email software in PC or mobile phone via email servers. You are able to know machining conditions (such as machining completion, stop and failure) even if you are in a remote place.

"Email notification to operator" specification is required to use this function.

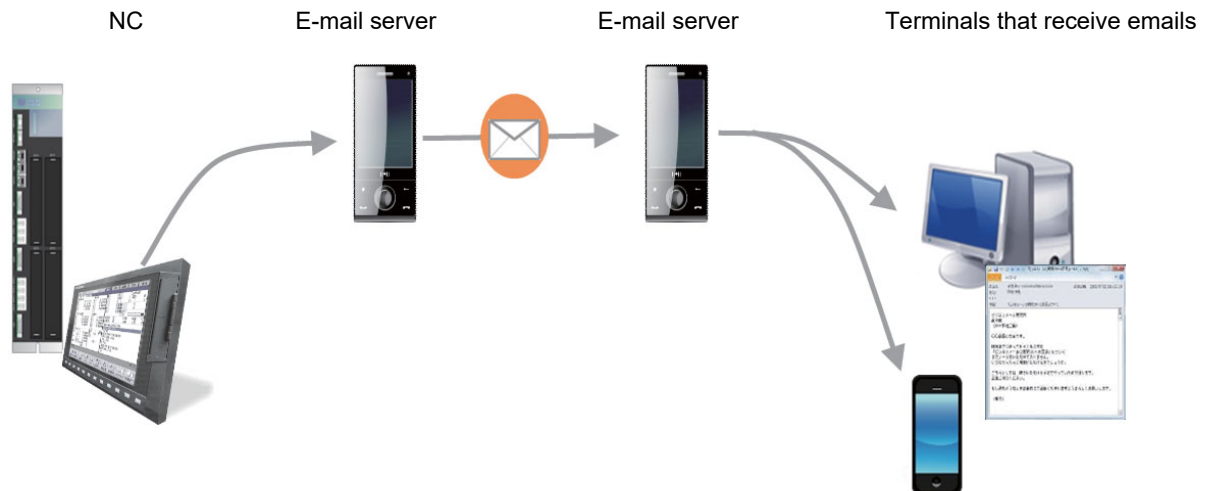

### ■ Environment establishment

To use this function, NCs must be connected to the Internet. Connect LAN cable to NC units, and set the following parameters in accordance with rules of the connected network environment.

| Parameter No. | Item               | Details                                             |
|---------------|--------------------|-----------------------------------------------------|
| #1926         | Global IP address  | Set the NC IP address seen from an external source. |
| #1927         | Global Subnet mask | Set the subnet mask for the IP address.             |
| #1928         | Global Gateway     | Set the IP address for the gateway.                 |

### ■ Note

- (1) TCP/IP is only protocol usable for the LAN connection.
- (2) The supported email server authentications are SMTP authentication and POP before SMTP authentication. Other authentications (such as Microsoft Exchange Server and SSL) are not supported.

## 9.10.1 Setting for Email Transmission Environment

Press the menu [Email] on the [Setup] screen to set the various items.

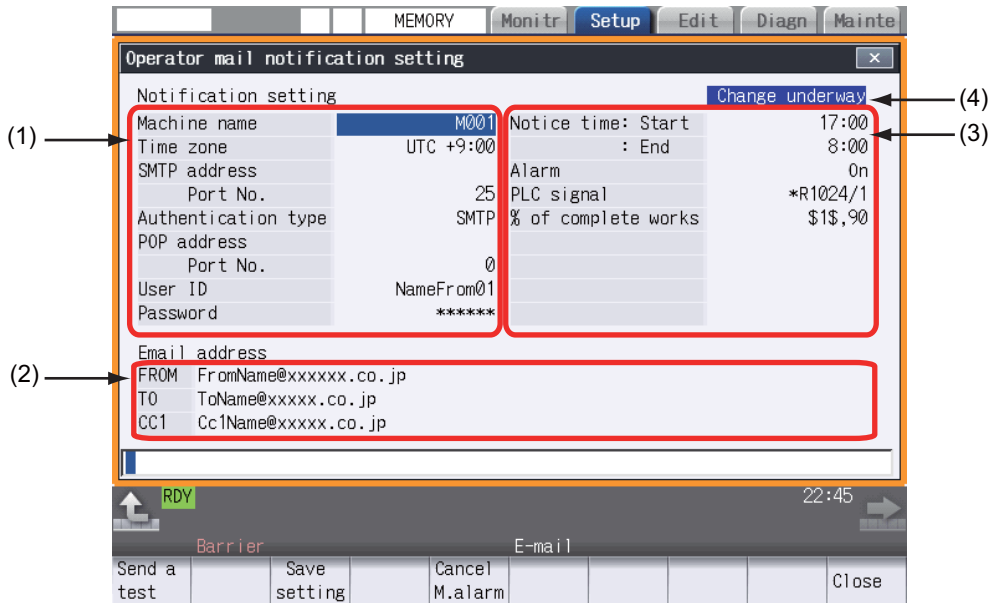

## Display items

| Display items                              | Details                                                                                                                                                                                                                                                                                                                                                                                                                                                                                                                                                                                                                                                                                                                                                                               |
|--------------------------------------------|---------------------------------------------------------------------------------------------------------------------------------------------------------------------------------------------------------------------------------------------------------------------------------------------------------------------------------------------------------------------------------------------------------------------------------------------------------------------------------------------------------------------------------------------------------------------------------------------------------------------------------------------------------------------------------------------------------------------------------------------------------------------------------------|
| (1) Email transmission environment setting | Set the items for email transmission environment.                                                                                                                                                                                                                                                                                                                                                                                                                                                                                                                                                                                                                                                                                                                                     |
| (2) Email address setting for transmission | Set email addresses of sender, recipient, etc.                                                                                                                                                                                                                                                                                                                                                                                                                                                                                                                                                                                                                                                                                                                                        |
| (3) Email transmission condition setting   | <p>Sets the conditions under which email transmission will be performed. It is optional whether you set "Notice time"; however, at least one item must be set (enabled) in "Alarm", "PLC signal" and "% of complete works" items. If none of these items are set, emails are not transmitted.</p> <p>An email is transmitted during automatic operation when an operating condition was satisfied with each of "Alarm", "PLC signal" or "% of complete works" setting items. Once an email was transmitted, there will be no email transmitted on the same setting item until automatic operation is completed.</p> <p>To send an email on the same transmission setting condition, automatic operation must be started after either machining program was completed or NC reset.</p> |
| (4) Change underway                        | This is displayed while one of the items (1) to (3) is being changed. Email notification stops while "Change underway" is displayed. To fix the change, press the menu [Save setting]. The confirmation message "Save the notification setting?(Y/N)" appears, then press the [Y] or [INPUT] key. "Change underway" disappears, and email notification will be enabled.                                                                                                                                                                                                                                                                                                                                                                                                               |

### Note

- (1) While in automatic operation, setting items cannot be changed on operator mail notification setting screen. If you attempt to change them, the error message "Executing automatic operation" is displayed. However, email notification setting information can be changed during single block stop.
- (2) If you attempt to set items for email notification in the following cases, the error message "Data protect" appears.
  - User's protection level is lower than that set by "Data protection by user's level" function.
  - Data protection key 2 is OFF (0).

■ Email transmission environment setting items and setting ranges

| Setting item        | Details                                                                                                                                                                                                                                           | Setting range                                       |
|---------------------|---------------------------------------------------------------------------------------------------------------------------------------------------------------------------------------------------------------------------------------------------|-----------------------------------------------------|
| Machine name        | Set machine name displayed in transmitted emails.<br>If not set, emails are sent with the machine name blank.                                                                                                                                     | Alphanumeric (16 characters or less)                |
| Time zone           | Set time zone.                                                                                                                                                                                                                                    | -12:00 to 14:00                                     |
| SMTP address        | Set SMTP server name for transmission. TCP/IPv6 is not available.<br>You cannot set email servers only support SMTPS (e.g. Google email server).                                                                                                  | Alphanumeric and symbols (64 characters or less)    |
| SMTP Port No.       | Set SMTP port number for transmission.                                                                                                                                                                                                            | 0 to 65535                                          |
| Authentication type | Select authentication type from menu.                                                                                                                                                                                                             | SMTP authentication/ POP before SMTP authentication |
| POP address         | This item should be set only when you selected "POP before SMTP" authentication in "Authentication type". Set POP server name for receiving.<br>This item is not necessary when you selected "SMTP" authentication (The setting will be ignored). | Alphanumeric and symbols (64 characters or less)    |
| POP Port No.        | This item should be set only when you selected "POP before SMTP" authentication in "Authentication type". Set POP port number for receiving.<br>This item is not necessary when you selected "SMTP" authentication (The setting will be ignored). | 0 to 65535                                          |
| User ID             | Set user ID in conformity with the email environment used.                                                                                                                                                                                        | Alphanumeric and symbols (80 characters or less)    |
| Password            | Set password in conformity with the email environment used.<br>The input values are displayed in "*****".                                                                                                                                         | Alphanumeric and symbols (24 characters or less)    |

[About time zone setting]

Time zone is described in an email header at the time of transmission. If time zone is not included in the header, time of receipt may be displayed incorrectly depending of email software from which you receive the email. For this reason, set time zone in conformity with location in where machine is installed. If the time zone is not set, it is displayed in email headers as "0" (Greenwich Mean Time).

Example of time zone setting

| Setting value | Example of standard time zone                                                        |
|---------------|--------------------------------------------------------------------------------------|
| +12           | Kamchatka time, Russia - PETT                                                        |
| +11           | Srednekolymsk Time, Russia- SRET                                                     |
| +10           | Australian Eastern Standard Time - AEST<br>Vladivostok Time, Russia - VLAT           |
| +9:30         | Australian Central Standard Time - ACST                                              |
| +9            | Japan Standard Time -JST<br>Korea Standard Time - KST<br>Yakutsk Time, Russia - YAKT |
| +8            | Australian Western Standard Time - AWST<br>Irkutsk Time, Russia - IRKT               |
| +7            | Krasnoyarsk Time, Russia - KRAT                                                      |
| +6            | Omsk Time, Russia - OMST                                                             |
| +5:30         | Indian Standard Time - IST                                                           |
| +5            | Yekaterinburg Time, Russia - YEKT                                                    |
| +4            | Samara Time, Russia - SAMT                                                           |
| +3            | Moscow Time, Russia - MSK                                                            |
| +2            | Eastern European Time - EET<br>Kaliningrad Time, Russia - USZ1                       |
| +1            | Central European Time - CET or MET                                                   |
| 0             | Greenwich Mean Time - GMT<br>Western European Time - WET                             |
| -3:30         | Newfoundland Standard Time - NST                                                     |
| -4            | (The United States and Canada) Atlantic Standard Time - AST                          |
| -5            | (The United States and Canada) Eastern Standard Time - EST                           |
| -6            | (The United States and Canada) Central Standard Time - CST                           |
| -7            | (The United States and Canada) Mountain Standard Time - MST                          |
| -8            | (The United States and Canada) Pacific Standard Time - PST                           |
| -9            | Alaska Standard Time - AKST                                                          |
| -10           | Hawaii-Aleutian Standard Time - HAST(HST)                                            |

■Email address setting items

| Setting item | Details                                                          | The number of registrable addresses |
|--------------|------------------------------------------------------------------|-------------------------------------|
| FROM         | Set email transmission source address                            | 1 (Required)                        |
| TO           | Set recipient's email address                                    | 1 (Required)                        |
| CC           | Set email addresses to be carbon copied other than the recipient | 8                                   |

Email transmission source address can also be set by inputting email transmission address file (MAILADDR.DAT) on I/O screen of the maintenance (Mainte) screen. For details, refer to "9.10.4 Inputting and Outputting Data".

**Note**

- (1) Make sure to set the items "FROM" and "TO". If an email is transmitted without either one unset, alarm "Z39 E-mail send error" is issued.

■ Email transmission setting items and setting ranges

| Setting item        | Details                                                                                                                                                                                                                                                                                                                                                                | Setting range                                       |
|---------------------|------------------------------------------------------------------------------------------------------------------------------------------------------------------------------------------------------------------------------------------------------------------------------------------------------------------------------------------------------------------------|-----------------------------------------------------|
| Notice time         | Set hours for emails to be transmitted (start and end time).<br>(Example 1) Start: 8:00 AM - End: 5:00 PM<br>Emails are sent between 8:00 AM and 5:00 PM.<br>(Example 2) Start: 5:00 PM - End: 8:00 AM<br>Emails are sent between 5:00 PM and 8:00 AM of the next morning<br>(Example 3) Start: 8:00 AM - End: 8:00 AM<br>Emails are sent all day long.                | 00:00 - 23:59                                       |
| Alarm               | Select from menu whether to send emails when alarms are issued:<br>Off (NOT send an email when an alarm is issued)<br>On (Send an email when a predetermined alarm is issued).<br>[Alarms for which emails are sent]<br>•Operation errors (M)<br>•Servo/Spindle alarms (S)<br>•MCP alarms<br>•System alarms (Z)<br>•Emergency stop alarms (EMG)<br>•Program errors (P) | Off/On                                              |
| PLC signal          | Set PLC signals for which emails are sent. (*1)<br>(Example 1) X**0/1<br>In case of bit device, set device number to X**0 or X**8. Also, set bit number between 0 and 7. (When you designate X129, set as X128/1.)<br>(Example 2) *R1024/1<br>*** means B contact and "/1" means bit 1 of word device.<br>(Example 3) 0<br>The settings are cleared.                   | Alphanumeric and symbols<br>(64 characters or less) |
| % of complete works | An email is transmitted when the specified proportion of machining is completed.<br>(Example 1) \$1\$, 80<br>Set part system and the proportion of the number of workpieces machined ("#8002 WRK COUNT"/"#8003 WRK COUNT LIMIT"). If this is unset, it is regarded as \$1.<br>(Example 2) 0<br>The settings are cleared.                                               | 0 to 100                                            |

(\*1) Usable devices and setting ranges are as follows:

| Device | Setting range | Device type | Device | Setting range  | Device type |
|--------|---------------|-------------|--------|----------------|-------------|
| X      | X0 to X1FFF   | Bit         | SM     | SM0 to SM16383 | Bit         |
| Y      | Y0 to Y1FFF   | Bit         | V      | V0 to V1023    | Bit         |
| M      | M0 to M122879 | Bit         | SW     | SW0 to SW7FF   | Word        |
| L      | L0 to L2047   | Bit         | SD     | SD0 to SD16383 | Word        |
| F      | F0 to F4095   | Bit         | D      | D0 to D8191    | Word        |
| SB     | SB0 to SB7FF  | Bit         | R      | R0 to R32767   | Word        |
| B      | B0 to B1BFFF  | Bit         | W      | W0 to W5FFF    | Word        |





## Menus

| Menus          | Details                                                                    |
|----------------|----------------------------------------------------------------------------|
| Send a test    | This executes email transmission test.                                     |
| Save setting   | This saves the email notification settings and enables the function again. |
| Cancel M.alarm | This cancels currently occurring alarm.                                    |
| Close          | This closes the pop-up window and quits this function.                     |

## 9.10.2 Email Transmission Test

You can test email transmission to confirm that an email is send properly in accordance with the set conditions.

## Operation method

- (1) Press the menu [Send a test].  The confirmation message "Send a test mail?(Y/N)" appears.
- (2) Press the [Y] or [INPUT] key.  The operation message "Test mail is being sent." appears.  
A test email is sent to all email addresses registered.  
When the test email transmission is completed, the message "Test sending is complete." appears.

[Example of test email]

Title: Test message from M001 (Machine name)  
 Date & Time: 2016/5/27(Fri) 13:10  
 To: ToName@xxxxx.co.jp

(Message)  
 Test message has been sent.

### Note

- (1) If there is an error in notification settings or parameter "#8134 E-mail send disabled" is set to "1", and a test email is transmitted, message "Test sending error" is displayed and alarm "Z39 E-mail send error" is issued. To cancel the operation, press the reset key or select the menu "Cancel M.alarm" of operator mail notification setting screen.
- (2) If wrong email address is set in "TO" or "CC" of "Email address" section and a test email is transmitted, message "Test sending is complete." is displayed. However, the test email is not send to the email addresses set in the "TO" or "CC". An email is transmitted from email server to the email address set in "FROM" to notify that the email transmission failed.

### 9.10.3 Description of Email Transmission Function

Emails are transmitted only during automatic operation (except test email transmission). When preparation is completed and email transmission conditions are satisfied during automatic operation, an email like a following example is sent to the registered addresses.

If you want to disable email transmission temporarily, set parameter "#8134 E-mail send disabled" to "1".

[Example of transmitted email]

Title: Message from M001 (Machine name)  
 Date & Time: 2016/5/27(Fri) 13:10  
 To: ToName@xxxxx.co.jp

(Message)  
 Below alarm is issued.  
 [Alarm message]  
 ○○: Alarm number

| Item    | Details                                                                                                                                                           |
|---------|-------------------------------------------------------------------------------------------------------------------------------------------------------------------|
| Title   | Name of source machine from which the email is transmitted.<br>(Example) If "MACHINE001" is set in the machine name, the title will be "Message from MACHINE001". |
| Message | Alarm message<br>Alarm number which is issued at the email transmission.                                                                                          |

#### Note

- (1) An email is transmitted if a condition for email transmission was already satisfied at startup of automatic operation.
- (2) Even if an alarm that matches email transmission condition is issued during graphic check, an email is not transmitted.

### 9.10.4 Inputting and Outputting Data

You can input/output email transmission address settings as email transmission address file (MAILADDR.DAT).

To select the address settings as input/output target, press the menu [Dir] - [Email address] on I/O screen of the maintenance (Mainte) screen.

The directory and file name are automatically entered when the menu [Email address] is selected.

| Device    | Memory                     |
|-----------|----------------------------|
| Directory | Email transmission address |
| File name | MAILADDR.DAT (*1)          |

(\*1) MAILADDR.DAT is a text file.

[Example of email transmission address file format]

```
[OPERATOR_MAILADDRESS]
FROM=FromName@xxxx.co.jp
TO=ToName@xxxx.co.jp
CC1=CC1Name@xxxx.co.jp
CC2=CC2Name@xxxx.co.jp
CC3=CC3Name@xxxx.co.jp
CC4=CC4Name@xxxx.co.jp
CC5=CC5Name@xxxx.co.jp
CC6=CC6Name@xxxx.co.jp
CC7=CC7Name@xxxx.co.jp
CC8=CC8Name@xxxx.co.jp
[OPERATOR_ENVIRONMENT]
USER_ID=NameFrom01
PASSWORD=12ABC#def@
```

| Class                | Key      | Setting data                      | Data range                                                                                             |
|----------------------|----------|-----------------------------------|--------------------------------------------------------------------------------------------------------|
| OPERATOR_MAILADDRESS | FROM     | Transmission source email address | 80 or less single-byte alphanumeric characters (lowercase/uppercase sensitive) and single-byte symbols |
|                      | TO       | Destination email address         |                                                                                                        |
|                      | CC1 to 8 | Email addresses carbon-copied     |                                                                                                        |
| OPERATOR_ENVIRONMENT | USER_ID  | User ID                           | 80 or less single-byte alphanumeric characters (lowercase/uppercase sensitive) and single-byte symbols |
|                      | PASSWORD | Password                          | 24 or less single-byte alphanumeric characters (lowercase/uppercase sensitive) and single-byte symbols |

## Precautions

### ■Precautions for inputting data

- (1) If space after "Key name (e.g. "FROM", "TO", etc.) =" is blank, the key data is cleared.
- (2) Characters after ; (semicolon) in a line are treated as comments.
- (3) In a case of an error (exceeding character limit, illegal key or format error), the subsequent portions are not input.

### ■Precautions for outputting data

- (1) In a case of unset data, only "Key names ("FROM", "TO", etc.)=" are output.

### ■Precautions for data protection

- (1) If you attempt to input/output the email transmission address file in the following cases, the error message "Data protect" appears.
  - User's protection level is lower than that set by "Data protection by user's level" function.
  - Data protection key 2 is OFF (0).

### ■Precautions for batch backups

- (1) The email transmission address file cannot be backed up by batch backup function.

## Machining a Workpiece

This chapter mainly describes the functions set on the monitor (Monitr) screen.

### 10.1 Operation Search



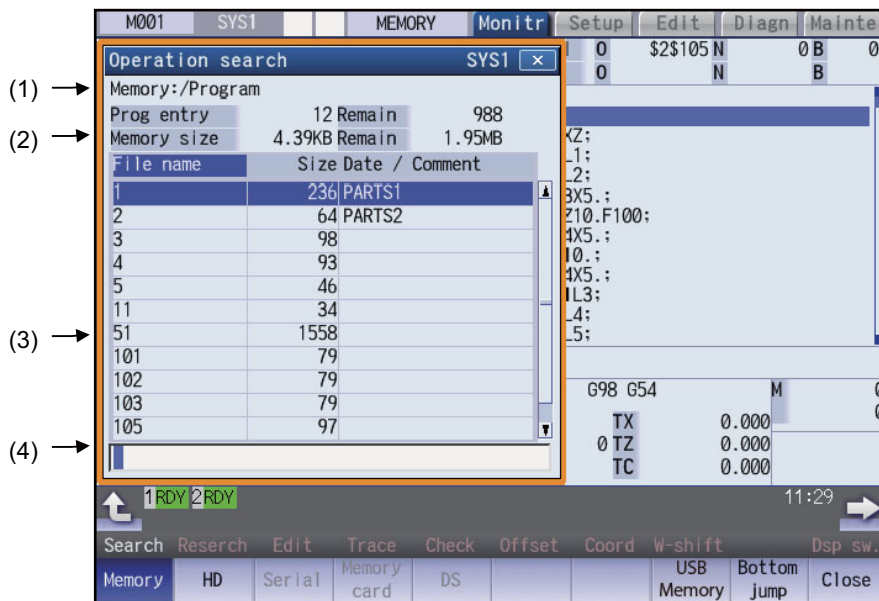

On this screen, the program can be called from the program storage site, such as a memory, by designating the program (program No.) to be automatically run and the program start position (sequence No., block No.).

When the multi-part system program management is valid (#1285 ext21/bit0 =1, ext21/bit1 =1) and [Memory] is selected as a device, the program search is executed across all part systems in batch.















**Display items**

| Display items                      | Details                                                                                 |
|------------------------------------|-----------------------------------------------------------------------------------------|
| (1) Device name, directory display | This displays the device and directory where the searched machining program is located. |
| (2) Capacity display               | This displays the capacity of the device displayed in (1).                              |

| Display items                     | Details                                                                                                                                                                                                                                                                                                                                                                                                                                                                                                                                                                                                                                                                                                                                                                                                                                                                                                                                                                                                                                                                                                                                                                            |
|-----------------------------------|------------------------------------------------------------------------------------------------------------------------------------------------------------------------------------------------------------------------------------------------------------------------------------------------------------------------------------------------------------------------------------------------------------------------------------------------------------------------------------------------------------------------------------------------------------------------------------------------------------------------------------------------------------------------------------------------------------------------------------------------------------------------------------------------------------------------------------------------------------------------------------------------------------------------------------------------------------------------------------------------------------------------------------------------------------------------------------------------------------------------------------------------------------------------------------|
| (3) List of directories and files | <p>This displays a list of the contents contained in the device or directory displayed in (1).</p> <p>Use  and  to scroll the displayed list.</p> <p>&lt;Display of "Date/Commnet" column&gt;</p> <p>When the device is HD, memory card, DS or USB memory, the file update date/time is displayed.</p> <p>For NC memory, the display can be switched as follows depending on the parameter "#8981 NCmemory date disp" setting: (*1)</p> <p>When #8981 is set to "0", the machining program comment is displayed.<br/>When #8981 is set to "1", the file update date/time is displayed.</p> <p>Whether to show or hide the comment field can be selected by pressing the menu [Comment nondisp]. When the comment field is hidden, the file name field will be enlarged. (Up to 13 characters can be displayed in the file name field when the comment is shown, and 32 when the comment is hidden.)</p> <p>If the file name exceeds the maximum number of characters, "*" will appear at the last character.</p> |
| (4) Input section                 | This displays details of the key input.                                                                                                                                                                                                                                                                                                                                                                                                                                                                                                                                                                                                                                                                                                                                                                                                                                                                                                                                                                                                                                                                                                                                            |

(\*1) For the program list view of the NC memory, the program comment is displayed when the multi-part system program management is valid (#1285 ext21/bit0 = 1), regardless of the parameter setting of "8981 NCmemory date disp".

## Menus

| Menus                                                                               | Details                                                                                                                                        |
|-------------------------------------------------------------------------------------|------------------------------------------------------------------------------------------------------------------------------------------------|
|  | <p>This selects the device for searching for the program.</p> <p>When a device with directory is selected, the route is selected first.</p>    |
|  |                                                                                                                                                |
|  |                                                                                                                                                |
|  |                                                                                                                                                |
|  |                                                                                                                                                |
|  |                                                                                                                                                |
|  | Display starts from the first page of the directory/list of files. The cursor moves to the top line.                                           |
|  | The last page of the directory/list of files is displayed. The cursor moves to the bottom line.                                                |
|  | This changes whether to show or hide the comment field in the list.<br>When the comment field is hidden, the file name field will be enlarged. |
|  | This updates the list contents. (The latest contents of the currently selected device and directory are listed.)                               |
|  | This changes the method of sorting the list.                                                                                                   |
|  | This closes the pop-up window and quits this function.                                                                                         |

**Note**

(1) Depending on the model, devices available on the monitor screens are different.

| Devices                          | Model                                           |                                                                                               |
|----------------------------------|-------------------------------------------------|-----------------------------------------------------------------------------------------------|
|                                  | Windows-based display unit of M800W/M80W Series | M800S Series, M80 Series, E80 Series, and non-Windows-based display unit of M800W/M80W Series |
| Memory                           | ○                                               | ○                                                                                             |
| HD                               | ○                                               | -                                                                                             |
| Serial                           | ○                                               | ○                                                                                             |
| Memory card (front-side SD card) | ○                                               | ○                                                                                             |
| DS (built-in SD card)            | ○                                               | ○                                                                                             |
| USB memory                       | ○                                               | ○                                                                                             |









(2) Some items may not be displayed depending on the device.

○: Displayed                      ×: Not displayed

| Display item/Device           | Memory | HD | Serial | Memory card | DS | USB memory |
|-------------------------------|--------|----|--------|-------------|----|------------|
| Number of programs registered | ○      | ○  | ×      | ○           | ○  | ○          |
| Remain                        | ○      | ×  | ×      | ×           | ×  | ×          |
| Number of memory characters   | ○      | ○  | ×      | ○           | ○  | ○          |
| Remain                        | ○      | ○  | ×      | ○           | ○  | ○          |
| List                          | ○      | ○  | ×      | ○           | ○  | ○          |

(3) When using serial, the port number set with parameter "#9005 TAPE MODE PORT" is connected, and search.

10.1.1 Executing an Operation Search

| Operation method                                                                                                                                                                                                                                                                                                                                                                                                                    |                                                                                                                                                                               |
|-------------------------------------------------------------------------------------------------------------------------------------------------------------------------------------------------------------------------------------------------------------------------------------------------------------------------------------------------------------------------------------------------------------------------------------|-------------------------------------------------------------------------------------------------------------------------------------------------------------------------------|
| (1) Press the  to select the part system to run.                                                                                                                                                                                                                                                                                                   | ➔ The selected part system appears on the upper left of the screen.                                                                                                           |
| (2) Press the main menu [Search].                                                                                                                                                                                                                                                                                                                                                                                                   | ➔ The sub-menu is displayed.<br>The list appears as a pop-up window.                                                                                                          |
| (3) Select the device.<br>(Example) [Memory]                                                                                                                                                                                                                                                                                                                                                                                        | ➔ The selected device name and root directory (memory:/) are displayed in the device name and directory display fields.                                                       |
| (4) Press the  ,  ,  or  key to move the cursor to the directory containing the file to be set. | ➔ Moves into the directory.                                                                                                                                                   |
| (5) Press the [INPUT] key.<br>If the list contents differ from the actual device or directory, press the menu [List Update].                                                                                                                                                                                                                                                                                                        |                                                                                                                                                                               |
| (6) Press  ,  ,  or  key to move the cursor to the machining program to be edited.              |                                                                                                                                                                               |
| (7) Press the [INPUT] key.                                                                                                                                                                                                                                                                                                                                                                                                          | ➔ The search starts.<br>When the search is completed, the searched device and program position appear in the display area for the machining program currently being executed. |

When designating the sequence number and block number and searching for the program, input the search conditions in the input area.

The program No. is categorized according to the presence of an extension.

| Input details | (Program No.)              | Sequence number | Block No. |
|---------------|----------------------------|-----------------|-----------|
| 1001/1/2      | O1001                      | N1              | B2        |
| 1001.PRG/1/2  | O1001.PRG                  | N1              | B2        |
| /1/2          | (Currently searched O No.) | N1              | B2        |
| 1001/2        | O1001                      | N0              | B2        |
| 1001/1        | O1001                      | N1              | B0        |
| 1001          | O1001                      | N0              | B0        |
| /1            | (Currently searched O No.) | N1              | B0        |
| //2           | (Currently searched O No.) | N0              | B2        |

**Note**

- (1) The maximum number of digits is eight for the sequence No. and nine for the block No.
- (2) Program after operation search
  - (a) Operation search is canceled if the following operations are carried out on the edit screen after operation search. Execute restart search in this case.
    - If the searched program is erased.
    - If the searched sequence No. is erased.
    - If the block corresponding to the searched block No. is erased.
  - (b) Operation search cannot be executed in another mode during MDI operation even if the block is stopped. Wait for MDI operation to end or reset the NC before searching.





- (3) A program with 33 or more file name characters cannot be searched.
- (4) Memory card, DS and USB memory are in the device access state during the operation. Do not remove the memory card, DS and USB memory during its operation. Failure to observe this could result in faults.
- (5) Searched program No. is memorized in NC even after the power is turned OFF. When NC starts up after the power is turned ON again, the program which has the previously searched program No. will be operated.
- (6) In case the USB memory is changed to another one, if the program has the same No. as previously searched program exists in the currently inserted USB memory, the program will be operated. When the program of the same No. does not exist in the USB memory, the program error (P232) will occur.
- (7) Sub part system I/II cannot be searched for M80 Series.
- (8) Sub part system II cannot be searched for M800 Series.

### 10.1.2 Changing Whether to Show or Hide the Comment Field

The file name field can be extended by changing whether to show or hide the comment field.

#### Operation method

- (1) Press the menu [Comment nondisp].  The file name is displayed up to 32 alphanumeric characters and symbols after the comment field disappears.
- (2) Press the highlighted [Comment nondisp] again.  The comment field appears, and the file name is displayed up to 13 alphanumeric characters and symbols.

(Example) When the file name is "123456789A123456789B123456789C12"

♦"Comment display" is validated: The file name display is omitted and "\*" is attached.

| File name     | Size | Date / Comment |
|---------------|------|----------------|
| 123456789A12* | 126  | COLOR_CHK_01   |

♦"Comment display" is invalidated: The file name is displayed up to 32 alphanumeric characters and symbols.

| File name                        | Size |
|----------------------------------|------|
| 123456789A123456789B123456789C12 | 126  |

#### Note

- (1) The set status is held even if the NC power is turned OFF.
- (2) The set status is common for list view of operation screen, restart search screen, etc.
- (3) The cursor moves to the head when display/non-display in the comment field is switched.

## 10.1.3 Changing the Sorting Method

- Sorting method changes to 1 -> 2 -> 3 -> 4 -> 5 -> 1.....every time the menu [Sort change] is pressed.
- When the sorting method 1, 2, or 3 is selected, "File name" column is highlighted. The sorting method 4 or 5 is selected, "Date/Comment" column is highlighted. ("1. File name No. ascending order" is selected by default setting.)
- The method is common for all the devices.
- You can sort up to the number shown in the table "Sortable number of files" below (the total number of files and directories, including current directory "." and one directory above "..") within a directory.
- "List updating" is displayed in flickering during sorting.
- If it exceeds the sortable number of files, the menu [Sort change] is grayed out and changing the sorting method is impossible. In this case, NC memory program is displayed with "6. Program No. ascending order". Program in other devices is displayed with "2. File name character code ascending order". In this case, "File name" column is highlighted regardless of the sorting method.

## Sorting method

| No. | Sorting method                            | Priority                                                                                                                                                                                     |
|-----|-------------------------------------------|----------------------------------------------------------------------------------------------------------------------------------------------------------------------------------------------|
| 1   | File name No. ascending order             | 1. "." for current directory, ".." for one directory above<br>2. Numerical value (excluding the case where "0" is put at the beginning) ascending order<br>3. Character code ascending order |
| 2   | File name character code ascending order  | 1. "." for current directory, ".." for one directory above<br>2. Character code ascending order                                                                                              |
| 3   | File name character code descending order | 1. Character code descending order<br>2. "." for current directory, ".." for one directory above                                                                                             |
| 4   | Comment ascending order                   | "Date/comment" character code ascending order                                                                                                                                                |
| 5   | Comment descending order                  | "Date/comment" character code descending order                                                                                                                                               |
| 6   | Program No. ascending order               | 1. Program No. (Numeric character) ascending order<br>2. Program No. (Character code) ascending order                                                                                        |

**Note**

- (1) The selected sorting method is held even after the power is turned OFF.
- (2) The selected sorting method is common for list view of the Monitor screen, Restart search screen, etc.
- (3) The character code ascending (descending) order is the method in which file names are compared one by one using the ASCII code.  
(Example) If the ascending order is applied, the appropriate order would be 1 to A because "1" equals to "0x31" and "A" equals to "0x41".
- (4) When the device is "Memory", display for "current directory" and "one directory above" is not available.
- (5) When comments are the same, sorting is carried out by the file name character code ascending (descending) order.
- (6) Comment names (dates) are compared using character code only. Thus, the order will not be one by the actual date.
- (7) When the number of the programs in the NC memory exceeds the sortable number of files, the programs are displayed with "6. Program No. ascending order".

## Sortable number of files

| Device      | Windows-based display unit of M800W/M80W Series | M800S Series, Windows-less display unit of M800W/M80W Series | M80 Series and E80 Series |
|-------------|-------------------------------------------------|--------------------------------------------------------------|---------------------------|
| Memory      | 128                                             | 128                                                          | 128                       |
| HD          | 1000                                            | -                                                            | -                         |
| Memory card | 1000 (*1)                                       | 250 (*1)                                                     | 128                       |
| DS          | 1000 (*1)                                       | 250 (*1)                                                     | 128                       |
| USB memory  | 1000 (*1)                                       | 250 (*1)                                                     | 128                       |

(\*1) The available sort volume can be designated using the parameter "#8937 File sort volume".

## 10.2 Checking the Movement under Machining (Monitor Screen)

### Monitr

Various information related to operation, such as the axis counter, speed display and MSTB command are displayed on the Monitor screen. In addition, you can perform various monitoring operations, as shown below.

- (1) Search
- (2) Research
- (3) Editing the searched machining program
- (4) Check (Display of NC program's tool movement path)
- (5) Trace (Display of machine movement path)
- (6) Correction of operating program's buffer
- (7) Counter set
- (8) Manual numerical value command, etc.

### 10.2.1 Screen Layout

The screen layout varies depending on whether the 2-part system simultaneous display (#11019 2-system display) is valid or invalid, operation mode, and the number of NC axes. Refer to the table below for details.

| Screen                                               |                      | Number of counter display axes | Input setup unit (#1003 iunit) | Select display       | Reference |
|------------------------------------------------------|----------------------|--------------------------------|--------------------------------|----------------------|-----------|
| Monitor screen (Normal view)                         |                      | Up to 5 axes                   | -                              | Hidden               | Screen 1  |
|                                                      |                      |                                |                                | Display              | Screen 2  |
|                                                      |                      | 6 axes or more                 | -                              | Hidden               | Screen 3  |
|                                                      |                      |                                |                                | Display              | -         |
| Monitor screen (Simple view)                         |                      | Up to 5 axes                   | Min. 0.01 $\mu\text{m}$        | Display not possible | Screen 4  |
|                                                      |                      |                                | Max. 0.001 $\mu\text{m}$       | Display not possible | Screen 5  |
|                                                      |                      | 6 axes or more                 | -                              | Display not possible |           |
| Monitor screen (Single counter) (15-type/19-type)    |                      | Up to 5 axes                   | -                              | Display              | Screen 6  |
| Monitor screen (Dual counter) (15-type/19-type)      |                      | Up to 8 axes                   | -                              | Display              | Screen 7  |
| Monitor screen (Quad counter) (15-type/19-type)      |                      | Up to 5 axes                   | -                              | Display              | Screen 8  |
| 2-part system simultaneous display                   | Counter1 (expand)    | Up to 4 axes                   | -                              | Display not possible | Screen 9  |
|                                                      | Dual counter         | Up to 4 axes                   | -                              | Display not possible | Screen 10 |
|                                                      |                      | 5 axes or more                 | -                              | Display not possible | Screen 11 |
|                                                      | Quad counter         | Up to 4 axes                   | -                              | Display not possible | Screen 12 |
| 2-part system simultaneous display (15-type/19-type) | Counter1 (expand)    | Up to 5 axes                   | -                              | Display not possible | Screen 13 |
|                                                      | Dual counter         | Up to 5 axes                   | -                              | Display not possible | Screen 14 |
|                                                      |                      | 6 axes or more                 | -                              | Display not possible | Screen 15 |
|                                                      | Quad counter         | Up to 5 axes                   | -                              | Display not possible | Screen 16 |
| 3-part system simultaneous display (15-type/19-type) | Counter1 (expand)    | Up to 5 axes                   | -                              | Display not possible | Screen 17 |
|                                                      | Dual counter         | Up to 5 axes                   | -                              | Display not possible | Screen 18 |
|                                                      |                      | 6 axes or more                 | -                              | Display not possible | Screen 19 |
|                                                      | Quad counter         | Up to 5 axes                   | -                              | Display not possible | Screen 20 |
| 4-part system simultaneous display (15-type/19-type) | Counter1 (expand)    | Up to 6 axes                   | -                              | Display not possible | Screen 21 |
|                                                      | Dual counter display | Up to 5 axes                   | -                              | Display not possible | Screen 22 |
|                                                      |                      | 6 axes or more                 | -                              | Display not possible | Screen 23 |
|                                                      | Quad counter display | Up to 5 axes                   | -                              | Display not possible | Screen 24 |

[1-part system display] (Parameter "#11019 2-systm display" = 0)

There are two types of screen displays: "Monitor screen (Normal view)" and "Monitor screen (Simple view)". This display can be switched using the menu [Dsp sw.]. However, the content of the display varies depending on the specification of NC axes.

- 8.4-type/10.4-type

<Screen 1: Monitor screen (Normal view) (Up to 5 axes)>

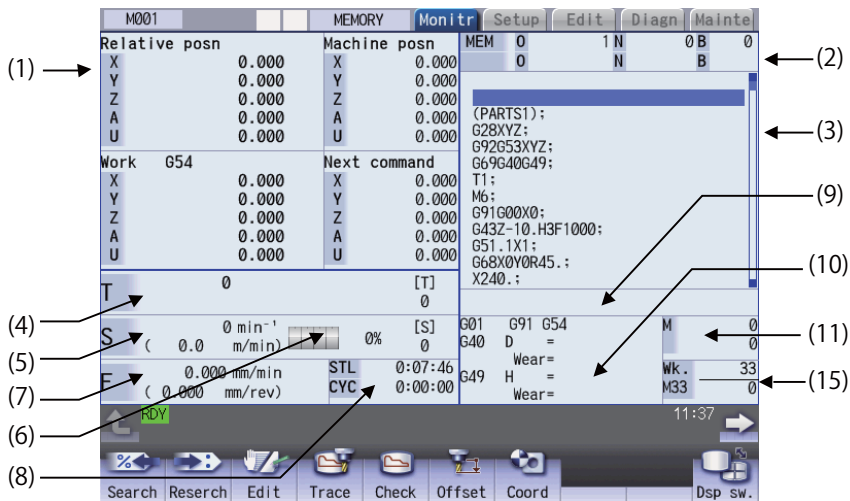

<Screen 2: Selectable display is valid>

When displaying monitor screen (normal view), display item on the bottom right of the screen can be changed, such as common variable, work coordinate system offset or tool compensation amount. To change the display, the parameter settings for "#8940 Selectable display" and "#8973 Set select display" are required.

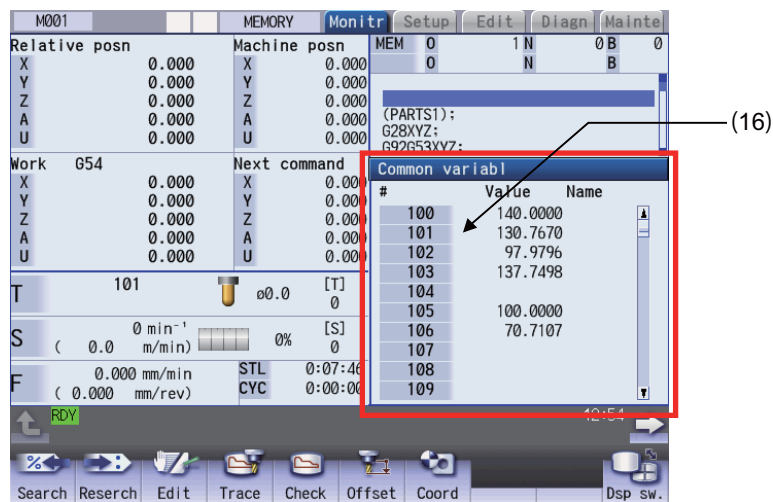

<Screen 3: Monitor screen (Normal view) (6 axes or more)>

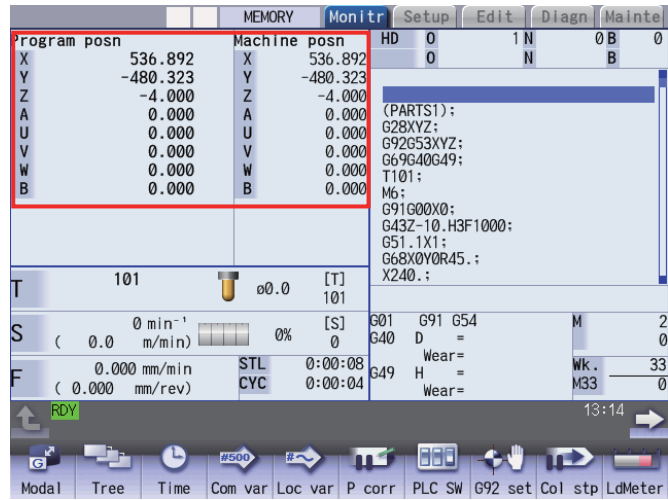

**Note**

(1) The maximum number of axes that can be displayed is 10 axes. Press the menu [Next axis] to switch display to display the subsequent axes.

<Screen 4: Monitor screen (Simple view) (Up to 5 axes and min. 0.01 μm)>

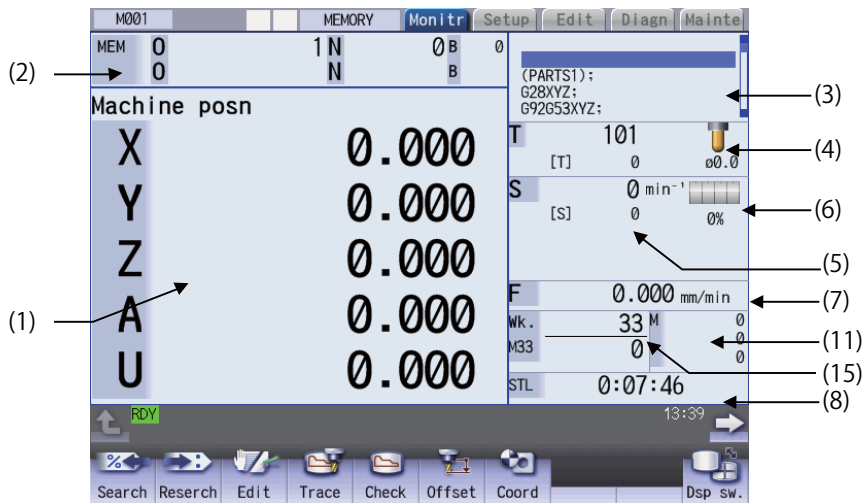

<Screen 5: Monitor screen (Simple view) (6 axes or more, and max. 0.001 μm)>

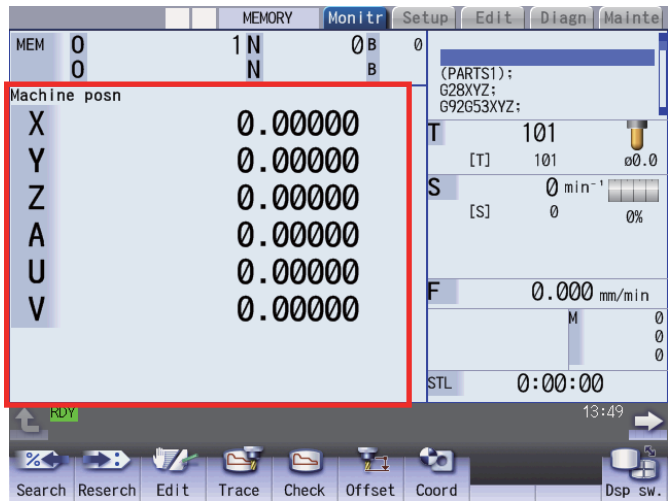

**Note**

(1) When the number of axes is 6 or more or the input unit is a maximum 0.01 μm in any one of the part systems, the screen display will change to the example shown above for all part systems. In this case the maximum number of axes that can be displayed are 8 axes.

- 15-type/19-type

<Screen 6: Monitor screen (Single counter) (15-type/19-type)>

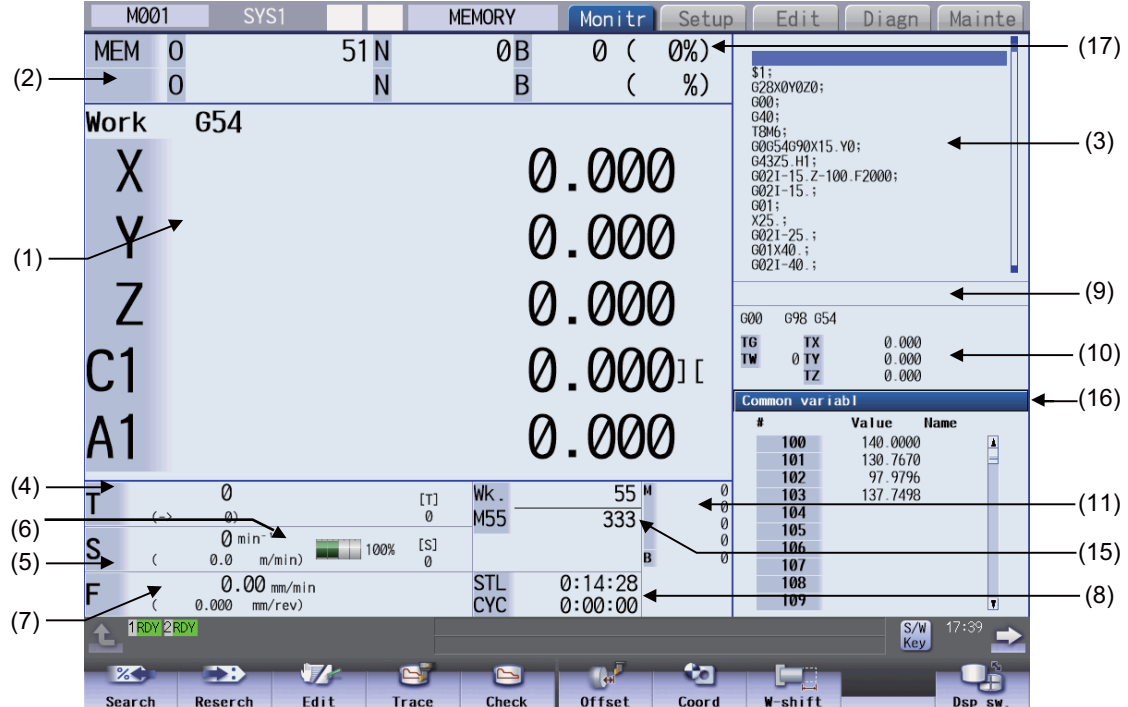

**Note**

(1) The maximum number of axes that can be displayed is 5 axes. Press the menu [Next axis] to switch display to display the subsequent axes.

<Screen 7: Monitor screen (Dual counter) (15-type/19-type)>

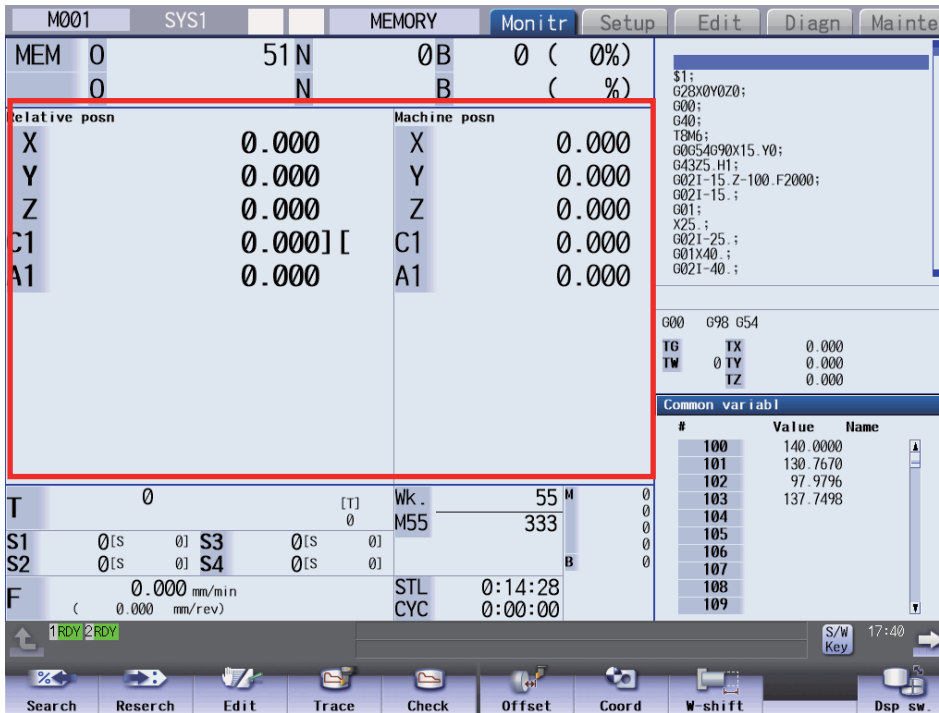

**Note**

(1) The maximum number of axes that can be displayed is 8 axes. Press the menu [Next axis] to switch display to display the subsequent axes.

<Screen 8: Monitor screen (Quad counter) (15-type/19-type)>

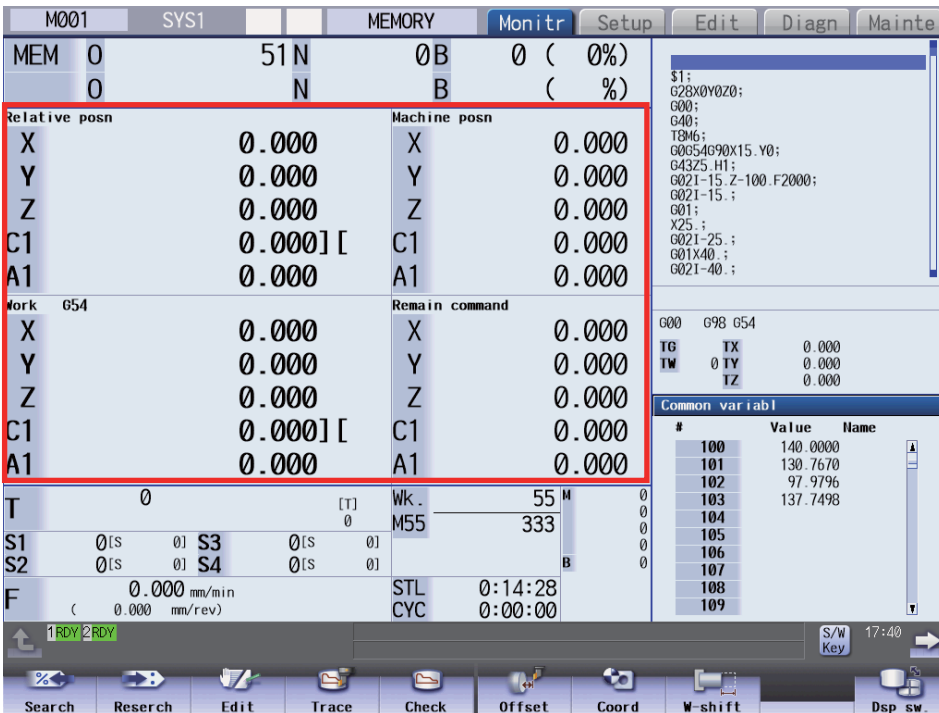

**Note**

(1) The maximum number of axes that can be displayed is 5 axes. Press the menu [Next axis] to switch display to display the subsequent axes.

[2-part system simultaneous display] (Parameter "#11019 2-systm display" = 1, 2)

- 8.4-type/10.4-type

■Counter1 (expand)

In "Counter1" (expand) display, single counter, MSTB display and currently executing program, etc. are displayed for each part system.

<Screen 9: Counter1 (expand) display>

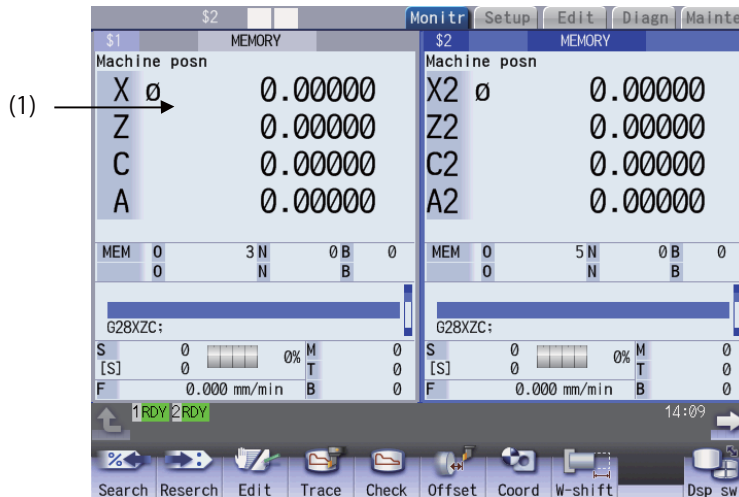

**Note**

(1) The maximum number of axes that can be displayed is 4 axes. Press the menu [Next axis] to switch display to display the subsequent axes.

■Dual counter display

In "Dual counter" display, two counters, MSTB display and currently executing program, etc. are displayed for each part system.

<Screen 10: Dual counter display (up to 4 axes)>

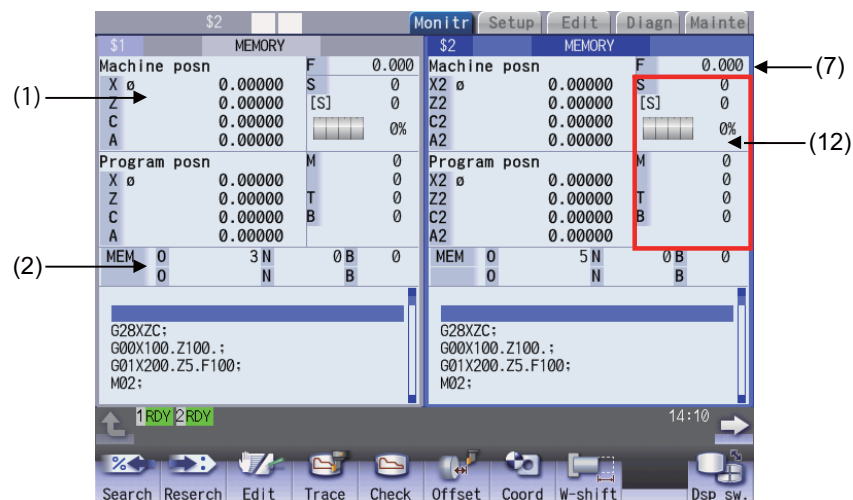



<Screen 11: Dual counter display (5 axes or more)>

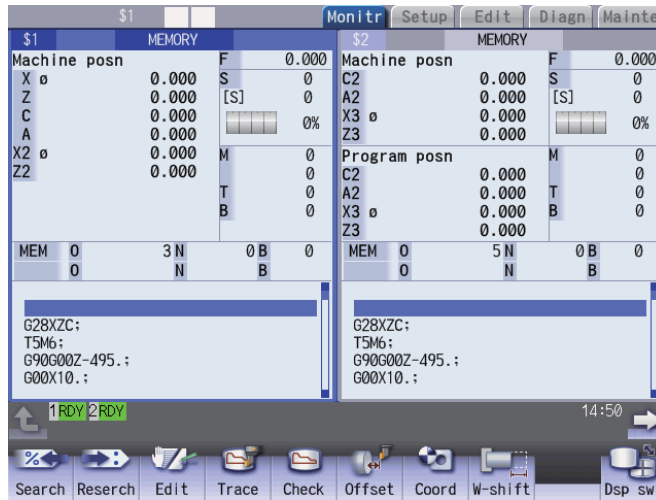

**Note**

(1) The maximum number of axes that can be displayed is 8 axes. Press the menu [Next axis] to switch display to display the subsequent axes.

■ Quad counter display

In "Quad counter" display, quad counter and currently executed program, etc. are displayed for each part system. In "Quad counter" display, the counter can display 0.001 μm or more.

<Screen 12: Quad counter display>

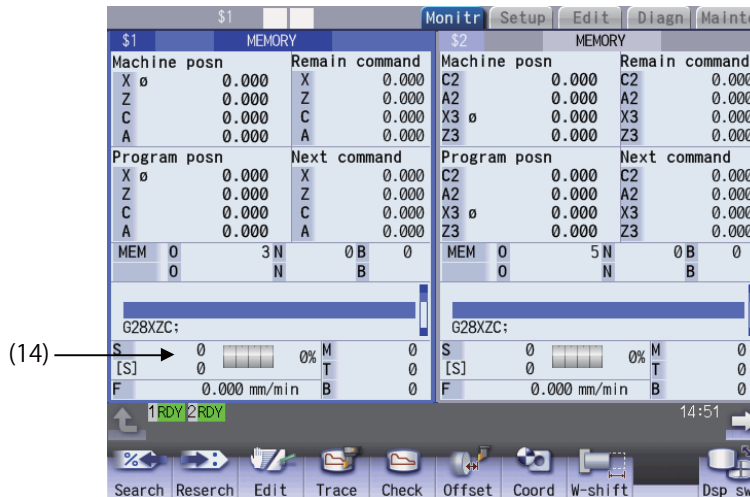

**Note**

(1) The maximum number of axes that can be displayed is 4 axes. Press the menu [Next axis] to switch display to display the subsequent axes.

- 15-type/19-type

■Counter1 (expand)

<Screen 13: Counter1 (expand) display>

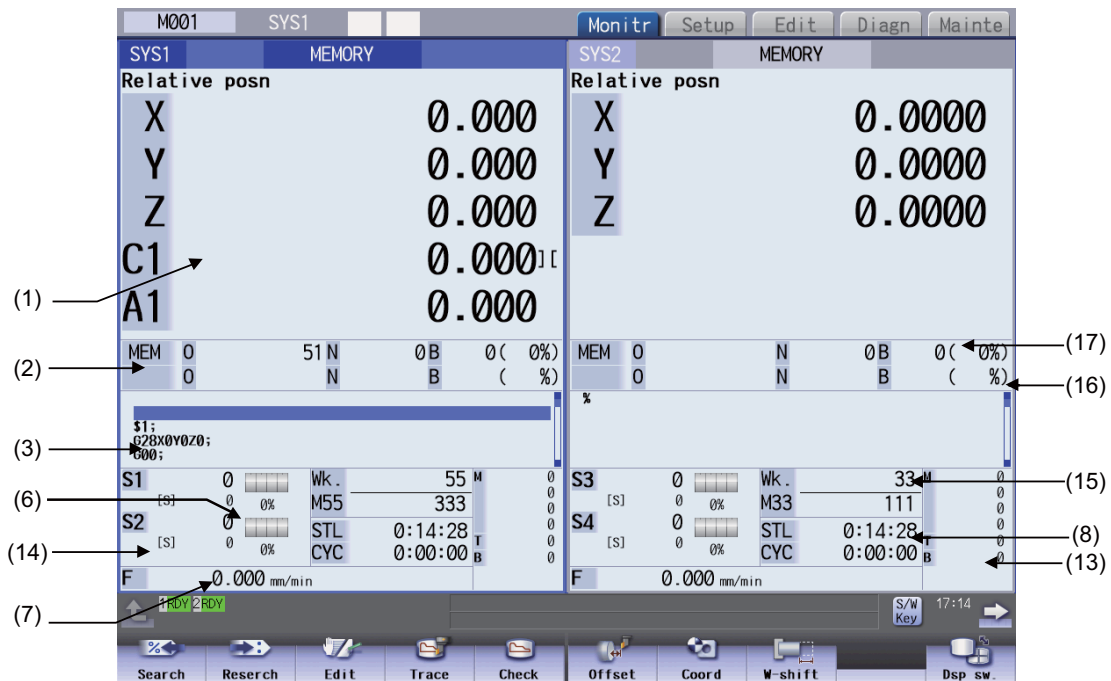

■ Note

(1) The maximum number of axes that can be displayed is 5 axes. Press the menu [Next axis] to switch display to display the subsequent axes.

■Dual counter display

<Screen 14: Dual counter display (up to 5 axes)>

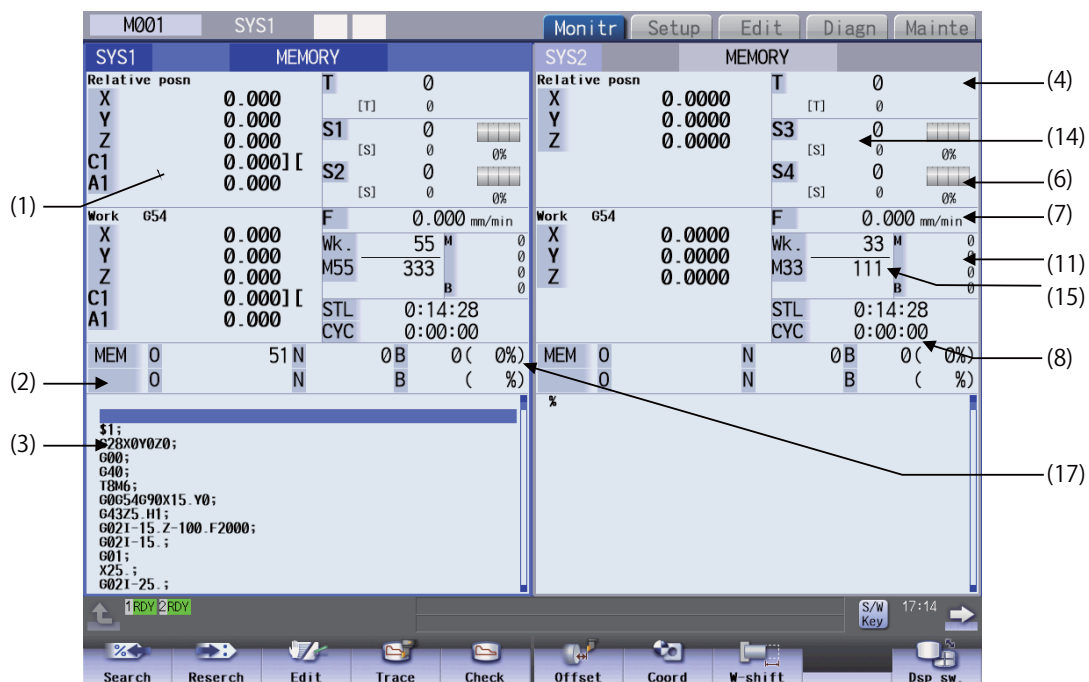

■ Note

(1) The maximum number of axes that can be displayed is 5 axes. Press the menu [Next axis] to switch display to display the subsequent axes.

<Screen 15: Dual counter display (6 axes or more)>

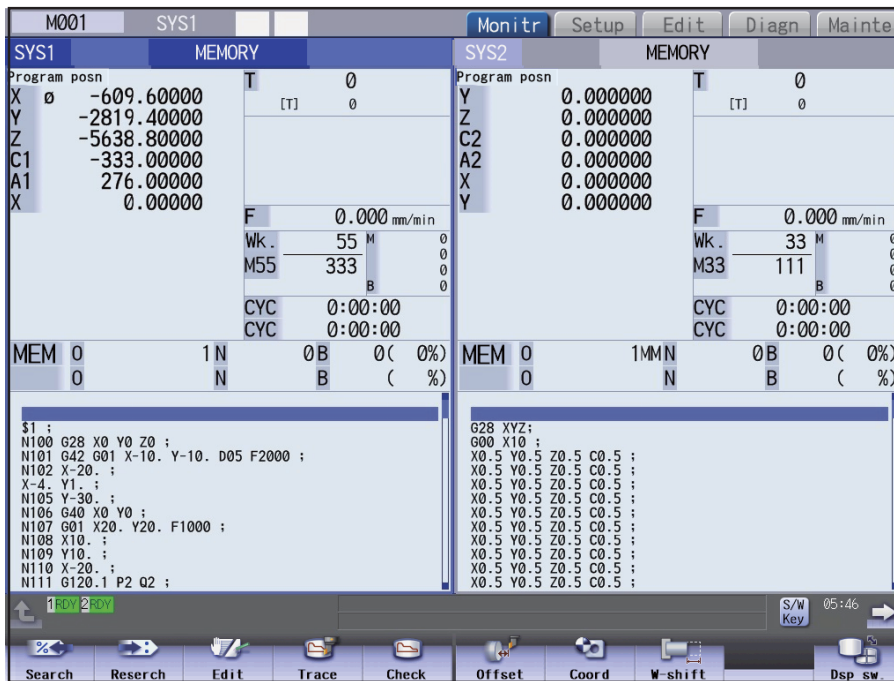

**Note**

(1) The maximum number of axes that can be displayed is 10 axes. Press the menu [Next axis] to switch display to display the subsequent axes.

■ Quad counter display

<Screen 16: Quad counter display>

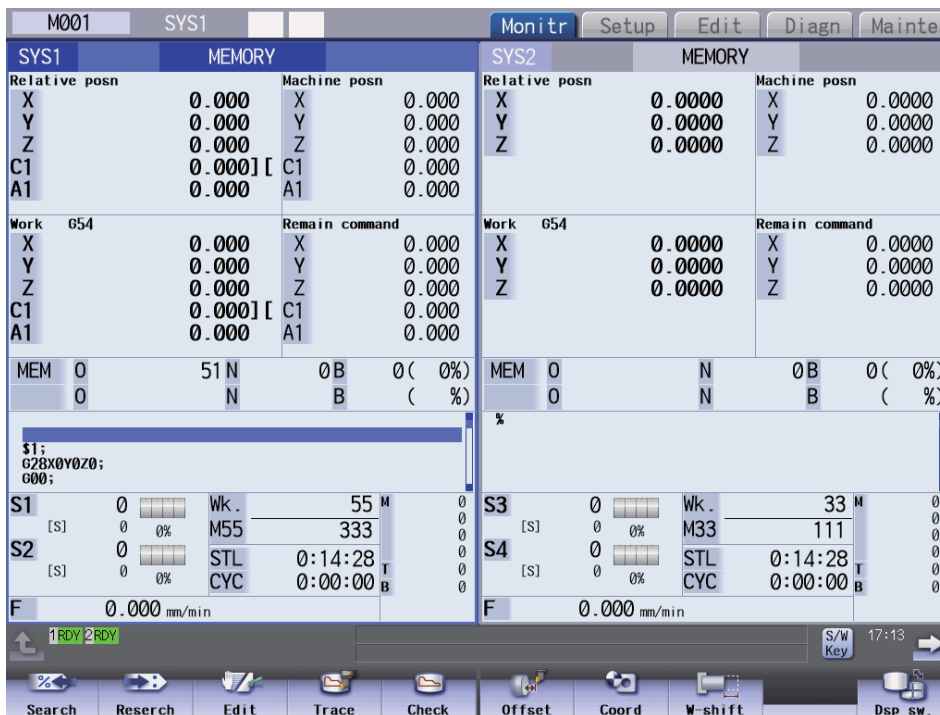

**Note**

(1) The maximum number of axes that can be displayed is 5 axes. Press the menu [Next axis] to switch display to display the subsequent axes.

[3-part system display] (Parameter "#11019 2-systm display" = 3)

- 15-type/19-type

■Counter1 (expand)

<Screen 17: Counter1 (expand) display>

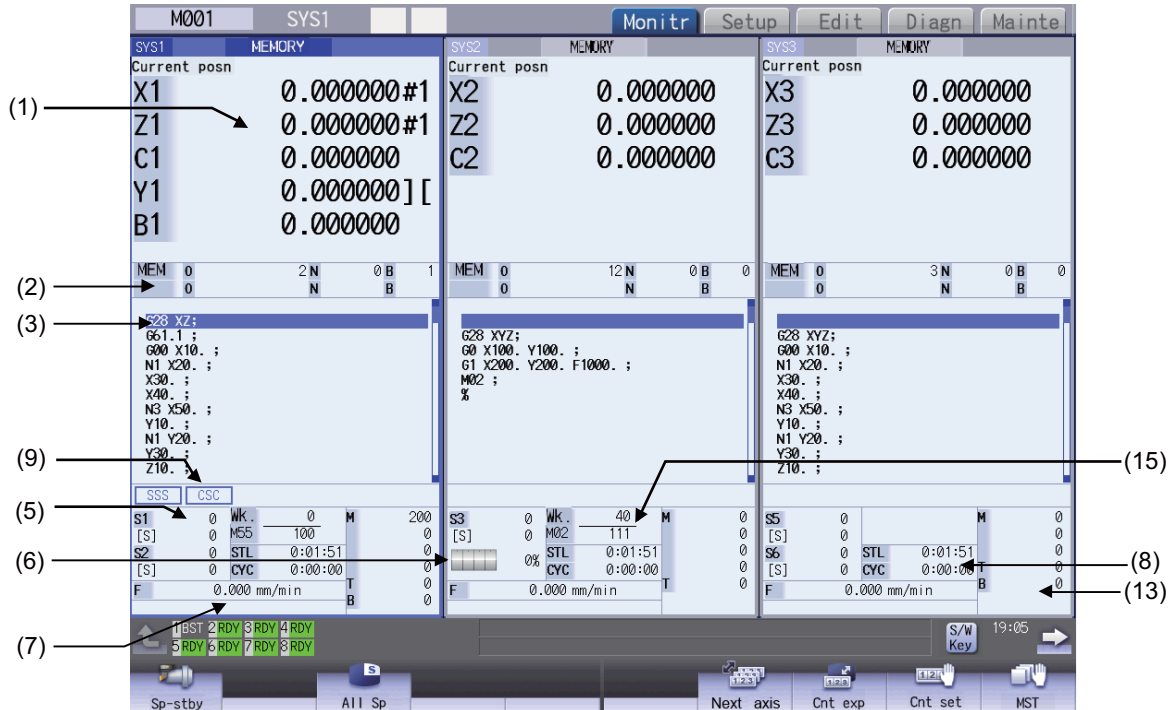

**Note**

(1) The maximum number of axes that can be displayed is 5 axes. Press the menu [Next axis] to switch display to display the subsequent axes.

■Dual counter display

<Screen 18: Dual counter display (up to 5 axes)>

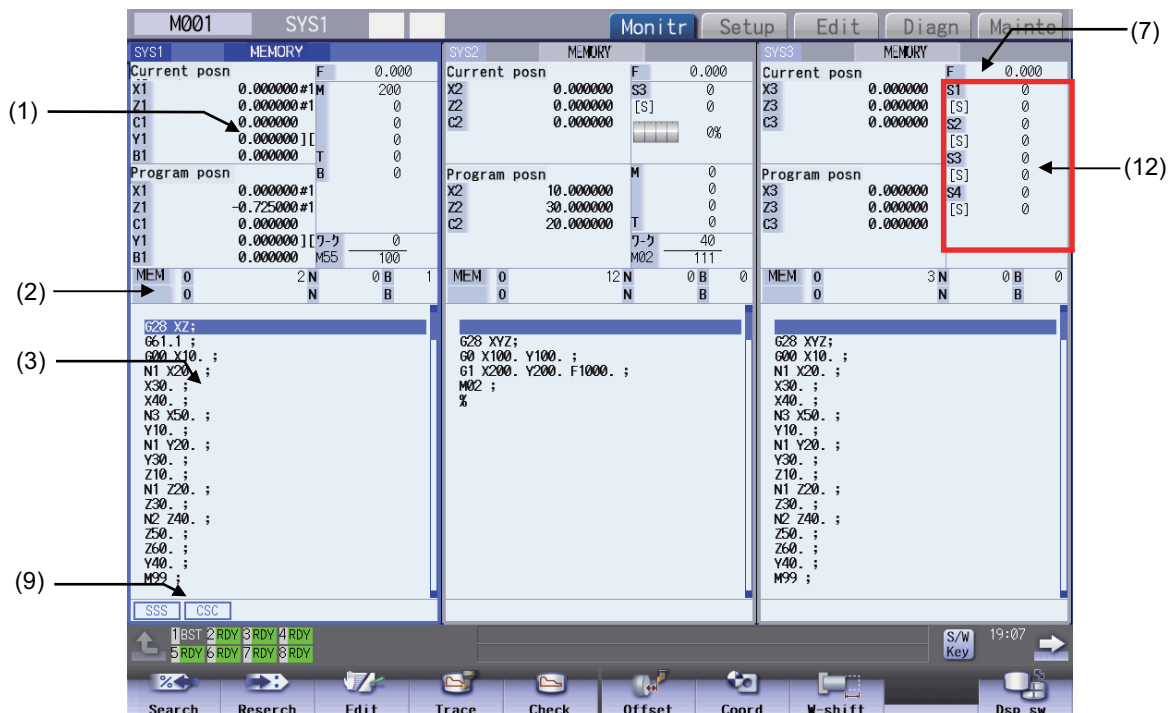

<Screen 19: Dual counter display (6 axes or more)>

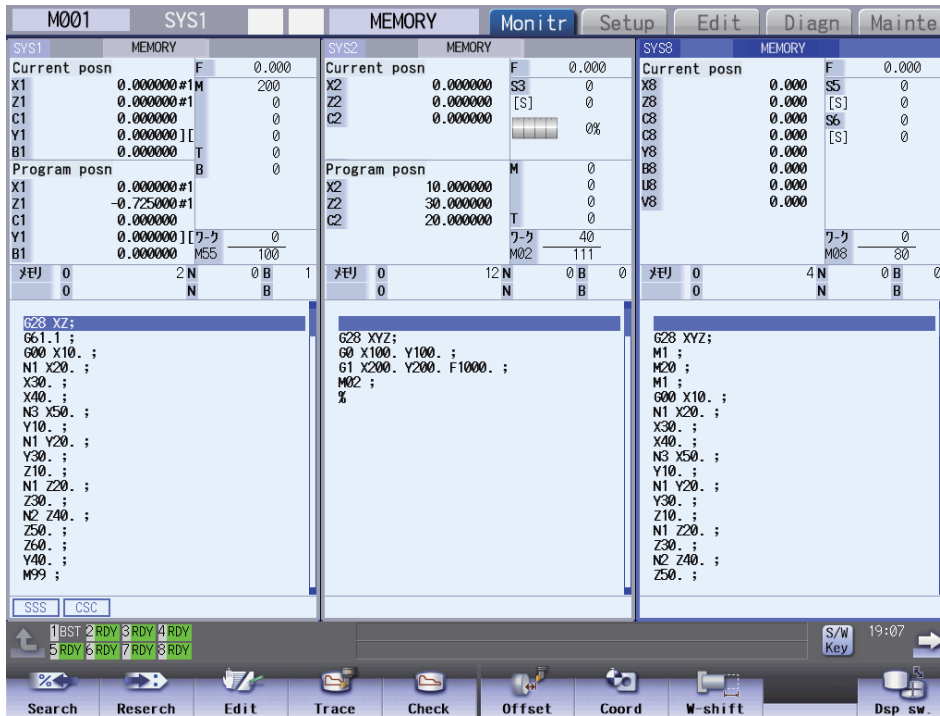

**Note**

(1) The maximum number of axes that can be displayed is 10 axes. Press the menu [Next axis] to switch display to display the subsequent axes.

■Quad counter display

<Screen 20: Quad counter display>

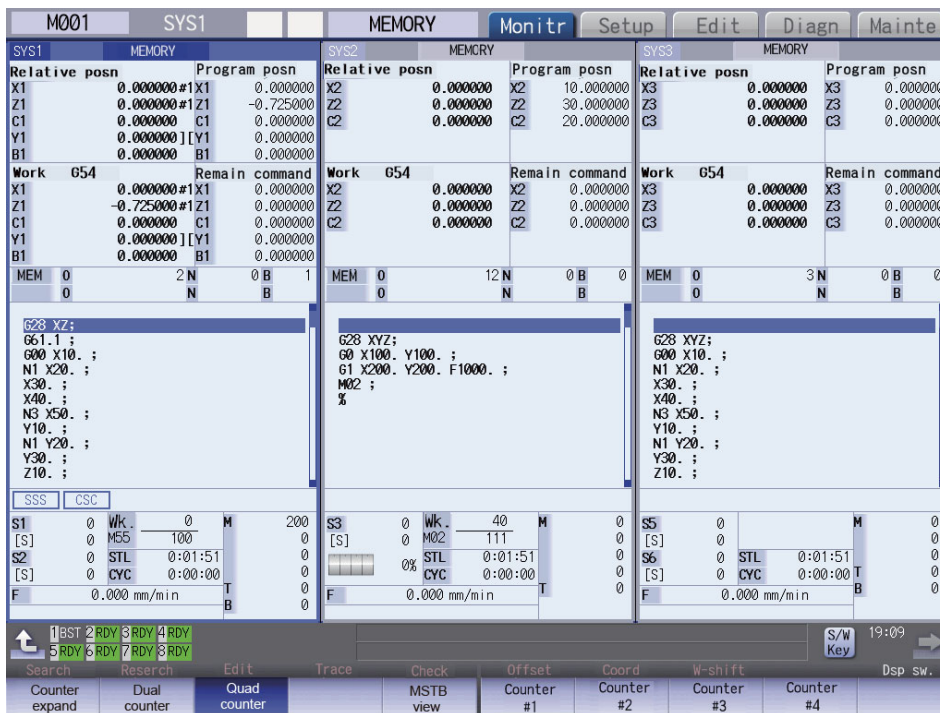

**Note**

(1) The maximum number of axes that can be displayed is 5 axes. Press the menu [Next axis] to switch display to display the subsequent axes.

[4-part system display] (Parameter "#11019 2-systm display" = 4)

- 15-type/19-type

■Counter1 (expand)

<Screen 21: Counter1 (expand) display>

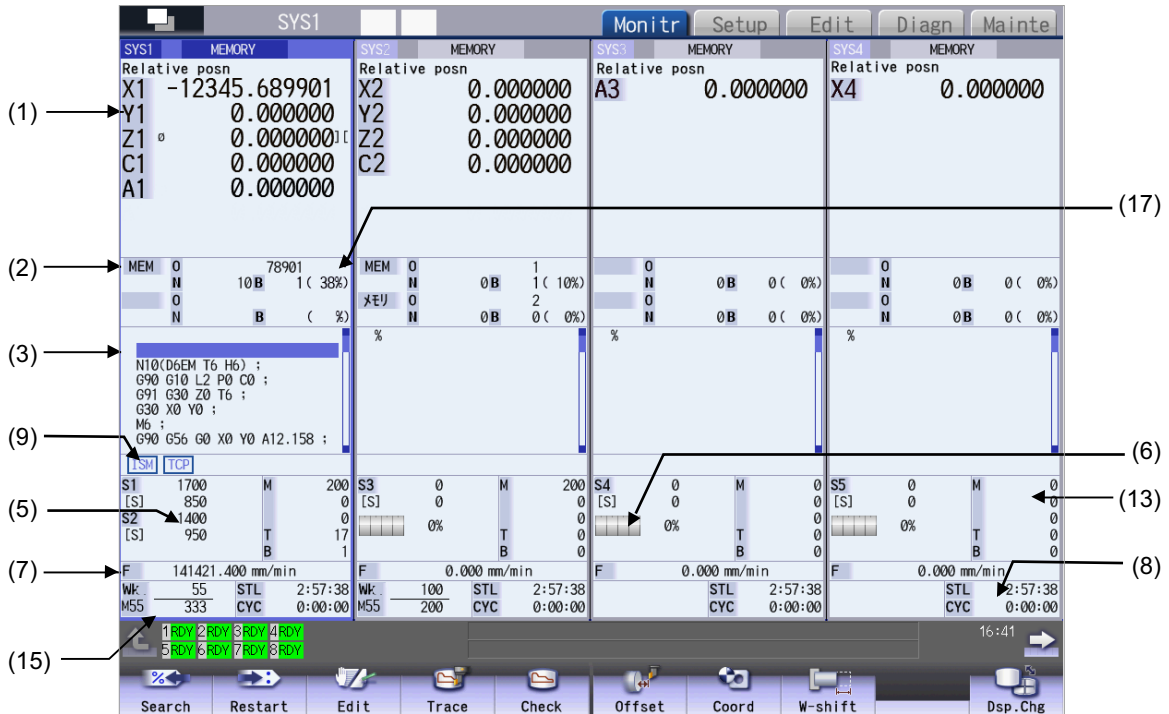

**Note**

(1) The maximum number of axes that can be displayed is 6 axes. Press the menu [Next axis] to switch display to display the subsequent axes.

■Dual counter display

<Screen 22: Dual counter display (up to 5 axes)>

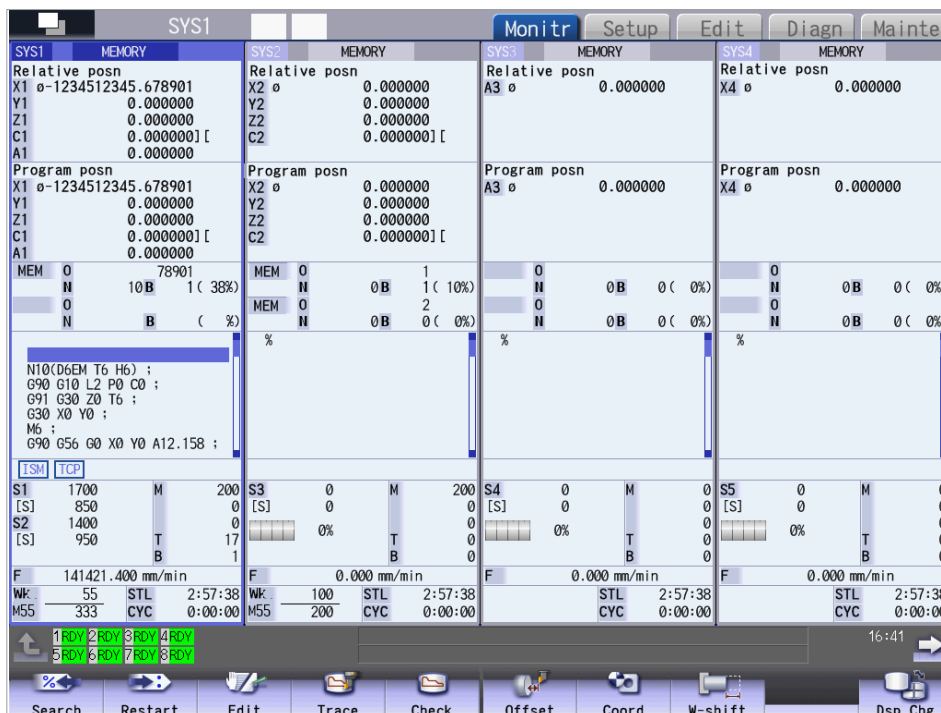



<Screen 23: Dual counter display (6 axes or more)>

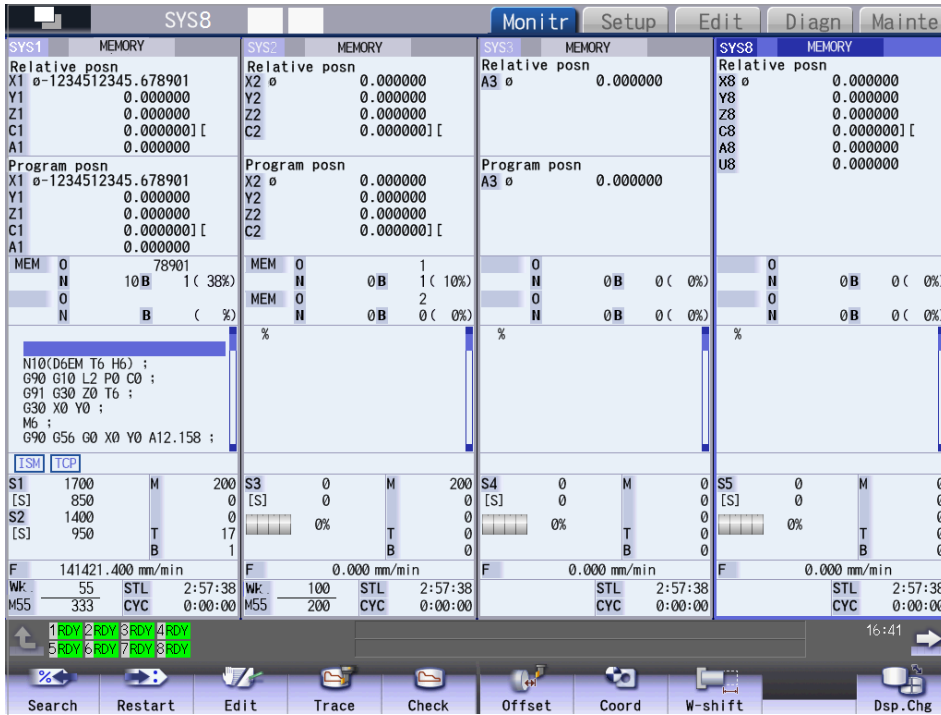

**Note**

(1) The maximum number of axes that can be displayed is 10 axes. Press the menu [Next axis] to switch display to display the subsequent axes.

**■Quad counter display**

<Screen 24: Quad counter display>

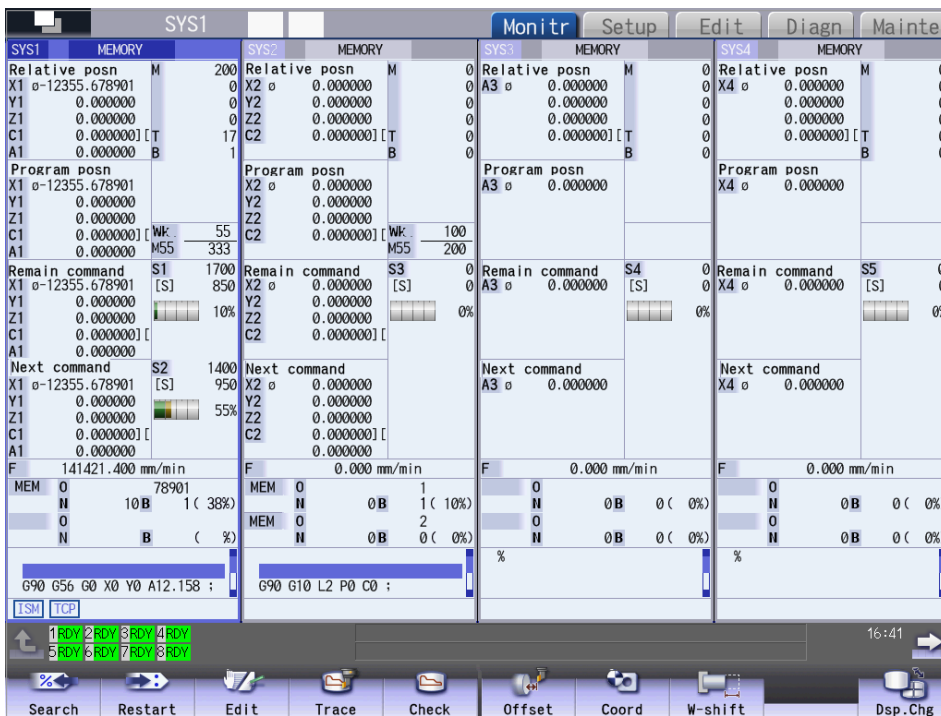



**Note**







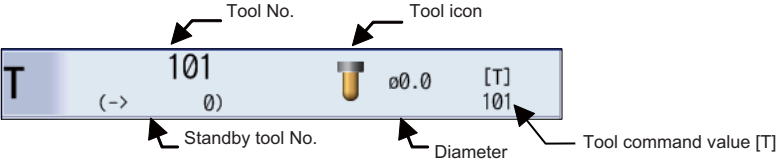
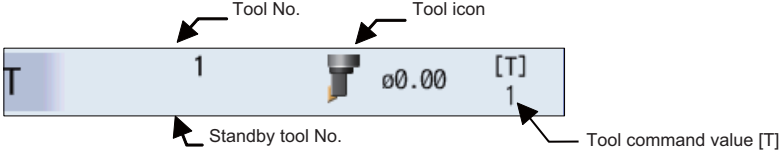
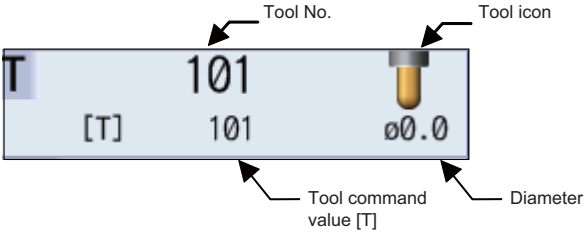
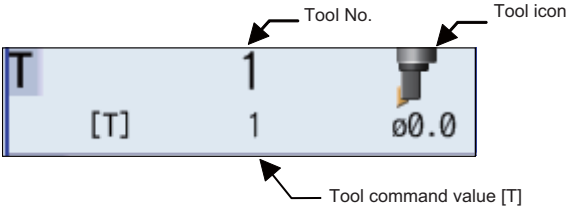

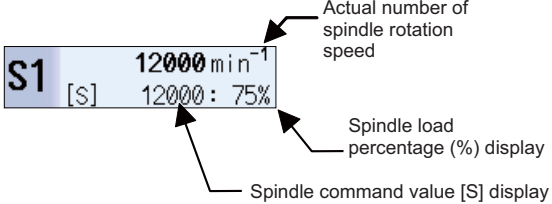
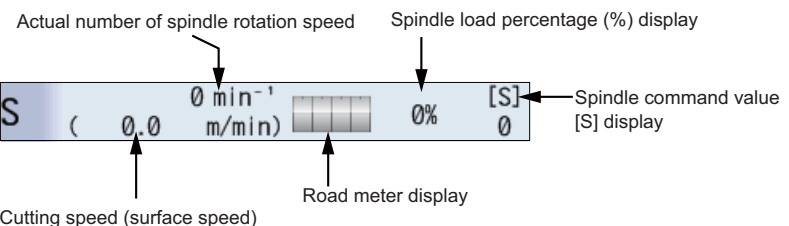
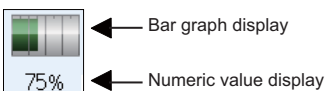

(1) The maximum number of axes that can be displayed is 5 axes. Press the menu [Next axis] to switch display to display the subsequent axes.

## Display items



| Display items                                 | Details                                                                                                                                                                                                                                                                                                                                                                                                                                                                                                                                                                                                                                                                                                                                                                                                                                                                                                                                                                                                                                                                                                                                                                                                                                                                                                                                                                                                                                                                                  |                |                                                                                    |                 |                                                                                                      |
|-----------------------------------------------|------------------------------------------------------------------------------------------------------------------------------------------------------------------------------------------------------------------------------------------------------------------------------------------------------------------------------------------------------------------------------------------------------------------------------------------------------------------------------------------------------------------------------------------------------------------------------------------------------------------------------------------------------------------------------------------------------------------------------------------------------------------------------------------------------------------------------------------------------------------------------------------------------------------------------------------------------------------------------------------------------------------------------------------------------------------------------------------------------------------------------------------------------------------------------------------------------------------------------------------------------------------------------------------------------------------------------------------------------------------------------------------------------------------------------------------------------------------------------------------|----------------|------------------------------------------------------------------------------------|-----------------|------------------------------------------------------------------------------------------------------|
| (1) Counter display                           | <p>This area displays the counter of the relative position or workpiece coordinate position. If each axis is at a specific position or in a specific status, the following status abbreviations are displayed.</p> <p>#1 to #8: 1st to 8th reference position</p> <ul style="list-style-type: none"> <li>♦J]: Servo OFF state</li> <li>♦MR: Mirror image</li> <li>♦&gt;&lt;: Axis removed state</li> <li>♦CT: Auxiliary axis state</li> </ul> <p>(Displayed when an axis that can be switched between the NC axis and auxiliary axis is set to the auxiliary axis state.)</p> <p>You can designate whether to consider the tool length compensation or tool radius compensation depending on the value of the parameter "#1287 ext23/bit4".</p> <p>The axis counter can be displayed or hidden depending on the value of the parameter "#1069 no_dsp".</p> <p>Also, if the axis is set to the diameter axis or uncontrol axis, the following symbol is displayed on the right of the axis name.</p> <ul style="list-style-type: none"> <li>*: Uncontrol axis (axis where any part system does not have control rights)</li> <li>φ: Diameter axis</li> </ul> <p>(When the target axis is equivalent to both the uncontrol axis and diameter axis, the symbol of the uncontrol axis is displayed.)</p> <p>&lt;Note&gt;</p> <ul style="list-style-type: none"> <li>♦For PLC axis position counter, the status abbreviations, diameter axis and uncontrol axis are not displayed.</li> </ul> |                |                                                                                    |                 |                                                                                                      |
| (2) Currently executed machining program (*1) | <table border="1" data-bbox="248 1128 1450 1261"> <tr> <td data-bbox="248 1128 475 1196">Main<br/>O10...</td> <td data-bbox="475 1128 1450 1196">Displays the currently executed program number, sequence number, and block number.</td> </tr> <tr> <td data-bbox="248 1196 475 1261">Sub<br/>O1234...</td> <td data-bbox="475 1196 1450 1261">While a subprogram is executed, its program number, sequence number, and block number are displayed.</td> </tr> </table>                                                                                                                                                                                                                                                                                                                                                                                                                                                                                                                                                                                                                                                                                                                                                                                                                                                                                                                                                                                                                  | Main<br>O10... | Displays the currently executed program number, sequence number, and block number. | Sub<br>O1234... | While a subprogram is executed, its program number, sequence number, and block number are displayed. |
| Main<br>O10...                                | Displays the currently executed program number, sequence number, and block number.                                                                                                                                                                                                                                                                                                                                                                                                                                                                                                                                                                                                                                                                                                                                                                                                                                                                                                                                                                                                                                                                                                                                                                                                                                                                                                                                                                                                       |                |                                                                                    |                 |                                                                                                      |
| Sub<br>O1234...                               | While a subprogram is executed, its program number, sequence number, and block number are displayed.                                                                                                                                                                                                                                                                                                                                                                                                                                                                                                                                                                                                                                                                                                                                                                                                                                                                                                                                                                                                                                                                                                                                                                                                                                                                                                                                                                                     |                |                                                                                    |                 |                                                                                                      |
| (3) Buffer display                            | <p>This displays the contents of the machining program currently being executed. The block being executed is highlighted.</p> <p>When the parameter "#1122 pglk_c" is enabled, the contents of the program are not displayed. Only "%" is displayed.</p> <p>&lt;Note&gt;</p> <ul style="list-style-type: none"> <li>♦If the program comment includes the double-byte width character for one character code, the program may not be displayed correctly.</li> </ul>                                                                                                                                                                                                                                                                                                                                                                                                                                                                                                                                                                                                                                                                                                                                                                                                                                                                                                                                                                                                                      |                |                                                                                    |                 |                                                                                                      |

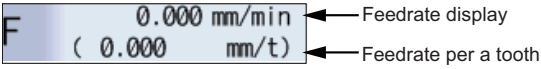

| Display items               | Details                                                                                                                                                                                                                                                                                                                                                                                                                                                                                                                                                                                                                                                                                                                                                                                                                                                                                                                                                                                                                                                                                                                                                                                                                                                                                                                                                                                                                                                                                                                                                                                                                                                                                                                                                                                                                                                                                                                                                                                                                                                                                                                                                                                                                                                                                                                                                                                                                                                                                                                                                                       |
|-----------------------------|-------------------------------------------------------------------------------------------------------------------------------------------------------------------------------------------------------------------------------------------------------------------------------------------------------------------------------------------------------------------------------------------------------------------------------------------------------------------------------------------------------------------------------------------------------------------------------------------------------------------------------------------------------------------------------------------------------------------------------------------------------------------------------------------------------------------------------------------------------------------------------------------------------------------------------------------------------------------------------------------------------------------------------------------------------------------------------------------------------------------------------------------------------------------------------------------------------------------------------------------------------------------------------------------------------------------------------------------------------------------------------------------------------------------------------------------------------------------------------------------------------------------------------------------------------------------------------------------------------------------------------------------------------------------------------------------------------------------------------------------------------------------------------------------------------------------------------------------------------------------------------------------------------------------------------------------------------------------------------------------------------------------------------------------------------------------------------------------------------------------------------------------------------------------------------------------------------------------------------------------------------------------------------------------------------------------------------------------------------------------------------------------------------------------------------------------------------------------------------------------------------------------------------------------------------------------------------|
| <p>(4) Tool No. display</p> | <p>This area displays the tool number, standby tool number, T command value, and tool diagram of the currently selected tool.</p> <p>&lt;Monitor screen (Normal view) M system&gt;</p>  <p>&lt;Monitor screen (Normal view) L system&gt;</p>  <p>&lt;Monitor screen (Simple view) M system&gt;</p>  <p>&lt;Monitor screen (Simple view) L system&gt;</p>  <p>Tool No.: Displays the tool number of the currently selected tool.</p> <p>Standby tool No.: Displayed only when standby tool 1 is designated.<br/>This is not displayed on the monitor screen (simple view).</p> <p>Tool icon: Displays the type of the currently selected tool with an image.</p> <p>The icon designated on the tool management screen is displayed. (*2)<br/>If the lifetime of the tool in use exceeds 90% of the designated tool lifetime value, the background color of the tool icon is changed to yellow.<br/>When the lifetime of the tool in use is expired, the background color of the tool icon is changed to red, and it blinks.</p> <p>&lt;Display example&gt;</p> <div style="display: flex; justify-content: space-around; align-items: center;"> <div style="text-align: center;"> <p>When the tool life will come soon</p>  </div> <div style="text-align: center;"> <p>When the tool life has been expired</p>  </div> </div> <p>(The background color blinks.)</p> <p>Diameter: Displays the diameter value of the currently selected tool.<br/>The value designated on the tool management screen is displayed.</p> <p>&lt;Note&gt;</p> <ul style="list-style-type: none"> <li>•For M system, if a tool with no diameter designated such as a cutting tool is selected, the diameter value is not displayed. For L system, if a tool with the diameter designated such as a milling tool is selected, the diameter is displayed.</li> </ul> <p>Tool command value [T]: Displays the T command value that is commanded last.<br/>In the L system, when "#11038 T disp typ" is set to "1", the diameter is displayed, including the compensation number.</p> |

| Display items                                                                       | Details                                                                                                                                                                                                                                                                                                                                                                                                                                                                                                                                                                                                                                                                                                                                                                                                                                                                                                                                                                                                                                                                                                                                                          |                                                                                      |                   |                   |                                                                                     |                                                                                     |                                                                                      |
|-------------------------------------------------------------------------------------|------------------------------------------------------------------------------------------------------------------------------------------------------------------------------------------------------------------------------------------------------------------------------------------------------------------------------------------------------------------------------------------------------------------------------------------------------------------------------------------------------------------------------------------------------------------------------------------------------------------------------------------------------------------------------------------------------------------------------------------------------------------------------------------------------------------------------------------------------------------------------------------------------------------------------------------------------------------------------------------------------------------------------------------------------------------------------------------------------------------------------------------------------------------|--------------------------------------------------------------------------------------|-------------------|-------------------|-------------------------------------------------------------------------------------|-------------------------------------------------------------------------------------|--------------------------------------------------------------------------------------|
| (5) Spindle rotation speed display                                                  | <p>This area displays the actual number of spindle rotation speed as well as the spindle command value.</p>   <p>Actual number of spindle rotation speed</p> <p>Spindle load percentage (%) display</p> <p>Spindle command value [S] display</p> <p>Actual number of spindle rotation speed</p> <p>Spindle load percentage (%) display</p> <p>Cutting speed (surface speed)</p> <p>Road meter display</p> <p>Spindle command value [S] display</p> <p>For L system, "0" is displayed in spindle cutting speed (surface speed).<br/>On the prototype or mass production screen, the values above vary depending on the value of the parameter "#1039 spinno".</p>                                                                                                                                                                                                                                                                                                                             |                                                                                      |                   |                   |                                                                                     |                                                                                     |                                                                                      |
| (6) Load meter display                                                              | <p>This area displays the spindle load value (%) with a bar graph and numeric values. The simple view shows the load meter of up to two spindles.</p>  <p>Bar graph display</p> <p>Numeric value display</p> <p>The graph display color varies depending on the spindle load value. This item blinks when a warning occurs. The caution and warning thresholds conform to the parameters #3192 to #3194.</p> <p>&lt;Display example&gt;</p> <table border="0" data-bbox="550 1254 1013 1366"> <tr> <td style="text-align: center;">80%<br/>(Normal)</td> <td style="text-align: center;">130%<br/>(Caution)</td> <td style="text-align: center;">175%<br/>(Warning)</td> </tr> <tr> <td style="text-align: center;"></td> <td style="text-align: center;"></td> <td style="text-align: center;"></td> </tr> </table> | 80%<br>(Normal)                                                                      | 130%<br>(Caution) | 175%<br>(Warning) |  |  |  |
| 80%<br>(Normal)                                                                     | 130%<br>(Caution)                                                                                                                                                                                                                                                                                                                                                                                                                                                                                                                                                                                                                                                                                                                                                                                                                                                                                                                                                                                                                                                                                                                                                | 175%<br>(Warning)                                                                    |                   |                   |                                                                                     |                                                                                     |                                                                                      |
|  |                                                                                                                                                                                                                                                                                                                                                                                                                                                                                                                                                                                                                                                                                                                                                                                                                                                                                                                                                                                                                                                                               |  |                   |                   |                                                                                     |                                                                                     |                                                                                      |

| Display items            | Details                                                                                                                                                                                                                                                                                                                                                                                                                                                                                                                                                                                                                                                                                                                                                                                                                                                                                                                                                                                                                                                                                                                                                                                                                                                                                                                                                                                                                                                                                                                                                                                                                                                                                                                                        |                                 |              |  |              |        |                |                 |   |                     |     |                                    |  |        |              |                                 |         |                     |        |           |  |        |      |                |                 |   |                     |     |                                    |  |          |              |                                 |         |                     |          |                          |  |          |
|--------------------------|------------------------------------------------------------------------------------------------------------------------------------------------------------------------------------------------------------------------------------------------------------------------------------------------------------------------------------------------------------------------------------------------------------------------------------------------------------------------------------------------------------------------------------------------------------------------------------------------------------------------------------------------------------------------------------------------------------------------------------------------------------------------------------------------------------------------------------------------------------------------------------------------------------------------------------------------------------------------------------------------------------------------------------------------------------------------------------------------------------------------------------------------------------------------------------------------------------------------------------------------------------------------------------------------------------------------------------------------------------------------------------------------------------------------------------------------------------------------------------------------------------------------------------------------------------------------------------------------------------------------------------------------------------------------------------------------------------------------------------------------|---------------------------------|--------------|--|--------------|--------|----------------|-----------------|---|---------------------|-----|------------------------------------|--|--------|--------------|---------------------------------|---------|---------------------|--------|-----------|--|--------|------|----------------|-----------------|---|---------------------|-----|------------------------------------|--|----------|--------------|---------------------------------|---------|---------------------|----------|--------------------------|--|----------|
| (7) Speed display        | <p>This area displays feedrate.</p>  <p>Interpolation feeding: Displays the vector-direction speed (FA), dwell time, etc. of the axis currently being moved.<br/>                     Each axis independent feeding: Displays the speed of the axis with the highest speed designated.<br/>                     When the parameter "#1125 real_f" is set to "1", the actual machine feedrate is displayed.<br/>                     The display units are as shown in the table below.</p> <table border="1" data-bbox="472 584 1369 1126"> <thead> <tr> <th>Metric/Inch</th> <th colspan="2">Pattern</th> <th>Display unit</th> </tr> </thead> <tbody> <tr> <td rowspan="5">Metric</td> <td rowspan="2">G4 in progress</td> <td>Feed per minute</td> <td>S</td> </tr> <tr> <td>Feed per revolution</td> <td>rev</td> </tr> <tr> <td colspan="2">Thread cutting (including dry run)</td> <td>mm/min</td> </tr> <tr> <td rowspan="2">Cutting feed</td> <td>Rotary axis independent command</td> <td>deg/min</td> </tr> <tr> <td>Feed per revolution</td> <td>mm/min</td> </tr> <tr> <td colspan="2">Any other</td> <td>mm/min</td> </tr> <tr> <td rowspan="5">Inch</td> <td rowspan="2">G4 in progress</td> <td>Feed per minute</td> <td>S</td> </tr> <tr> <td>Feed per revolution</td> <td>rev</td> </tr> <tr> <td colspan="2">Thread cutting (including dry run)</td> <td>inch/min</td> </tr> <tr> <td rowspan="2">Cutting feed</td> <td>Rotary axis independent command</td> <td>deg/min</td> </tr> <tr> <td>Feed per revolution</td> <td>inch/min</td> </tr> <tr> <td colspan="2">Any other than the above</td> <td>inch/min</td> </tr> </tbody> </table> | Metric/Inch                     | Pattern      |  | Display unit | Metric | G4 in progress | Feed per minute | S | Feed per revolution | rev | Thread cutting (including dry run) |  | mm/min | Cutting feed | Rotary axis independent command | deg/min | Feed per revolution | mm/min | Any other |  | mm/min | Inch | G4 in progress | Feed per minute | S | Feed per revolution | rev | Thread cutting (including dry run) |  | inch/min | Cutting feed | Rotary axis independent command | deg/min | Feed per revolution | inch/min | Any other than the above |  | inch/min |
| Metric/Inch              | Pattern                                                                                                                                                                                                                                                                                                                                                                                                                                                                                                                                                                                                                                                                                                                                                                                                                                                                                                                                                                                                                                                                                                                                                                                                                                                                                                                                                                                                                                                                                                                                                                                                                                                                                                                                        |                                 | Display unit |  |              |        |                |                 |   |                     |     |                                    |  |        |              |                                 |         |                     |        |           |  |        |      |                |                 |   |                     |     |                                    |  |          |              |                                 |         |                     |          |                          |  |          |
| Metric                   | G4 in progress                                                                                                                                                                                                                                                                                                                                                                                                                                                                                                                                                                                                                                                                                                                                                                                                                                                                                                                                                                                                                                                                                                                                                                                                                                                                                                                                                                                                                                                                                                                                                                                                                                                                                                                                 | Feed per minute                 | S            |  |              |        |                |                 |   |                     |     |                                    |  |        |              |                                 |         |                     |        |           |  |        |      |                |                 |   |                     |     |                                    |  |          |              |                                 |         |                     |          |                          |  |          |
|                          |                                                                                                                                                                                                                                                                                                                                                                                                                                                                                                                                                                                                                                                                                                                                                                                                                                                                                                                                                                                                                                                                                                                                                                                                                                                                                                                                                                                                                                                                                                                                                                                                                                                                                                                                                | Feed per revolution             | rev          |  |              |        |                |                 |   |                     |     |                                    |  |        |              |                                 |         |                     |        |           |  |        |      |                |                 |   |                     |     |                                    |  |          |              |                                 |         |                     |          |                          |  |          |
|                          | Thread cutting (including dry run)                                                                                                                                                                                                                                                                                                                                                                                                                                                                                                                                                                                                                                                                                                                                                                                                                                                                                                                                                                                                                                                                                                                                                                                                                                                                                                                                                                                                                                                                                                                                                                                                                                                                                                             |                                 | mm/min       |  |              |        |                |                 |   |                     |     |                                    |  |        |              |                                 |         |                     |        |           |  |        |      |                |                 |   |                     |     |                                    |  |          |              |                                 |         |                     |          |                          |  |          |
|                          | Cutting feed                                                                                                                                                                                                                                                                                                                                                                                                                                                                                                                                                                                                                                                                                                                                                                                                                                                                                                                                                                                                                                                                                                                                                                                                                                                                                                                                                                                                                                                                                                                                                                                                                                                                                                                                   | Rotary axis independent command | deg/min      |  |              |        |                |                 |   |                     |     |                                    |  |        |              |                                 |         |                     |        |           |  |        |      |                |                 |   |                     |     |                                    |  |          |              |                                 |         |                     |          |                          |  |          |
|                          |                                                                                                                                                                                                                                                                                                                                                                                                                                                                                                                                                                                                                                                                                                                                                                                                                                                                                                                                                                                                                                                                                                                                                                                                                                                                                                                                                                                                                                                                                                                                                                                                                                                                                                                                                | Feed per revolution             | mm/min       |  |              |        |                |                 |   |                     |     |                                    |  |        |              |                                 |         |                     |        |           |  |        |      |                |                 |   |                     |     |                                    |  |          |              |                                 |         |                     |          |                          |  |          |
| Any other                |                                                                                                                                                                                                                                                                                                                                                                                                                                                                                                                                                                                                                                                                                                                                                                                                                                                                                                                                                                                                                                                                                                                                                                                                                                                                                                                                                                                                                                                                                                                                                                                                                                                                                                                                                | mm/min                          |              |  |              |        |                |                 |   |                     |     |                                    |  |        |              |                                 |         |                     |        |           |  |        |      |                |                 |   |                     |     |                                    |  |          |              |                                 |         |                     |          |                          |  |          |
| Inch                     | G4 in progress                                                                                                                                                                                                                                                                                                                                                                                                                                                                                                                                                                                                                                                                                                                                                                                                                                                                                                                                                                                                                                                                                                                                                                                                                                                                                                                                                                                                                                                                                                                                                                                                                                                                                                                                 | Feed per minute                 | S            |  |              |        |                |                 |   |                     |     |                                    |  |        |              |                                 |         |                     |        |           |  |        |      |                |                 |   |                     |     |                                    |  |          |              |                                 |         |                     |          |                          |  |          |
|                          |                                                                                                                                                                                                                                                                                                                                                                                                                                                                                                                                                                                                                                                                                                                                                                                                                                                                                                                                                                                                                                                                                                                                                                                                                                                                                                                                                                                                                                                                                                                                                                                                                                                                                                                                                | Feed per revolution             | rev          |  |              |        |                |                 |   |                     |     |                                    |  |        |              |                                 |         |                     |        |           |  |        |      |                |                 |   |                     |     |                                    |  |          |              |                                 |         |                     |          |                          |  |          |
|                          | Thread cutting (including dry run)                                                                                                                                                                                                                                                                                                                                                                                                                                                                                                                                                                                                                                                                                                                                                                                                                                                                                                                                                                                                                                                                                                                                                                                                                                                                                                                                                                                                                                                                                                                                                                                                                                                                                                             |                                 | inch/min     |  |              |        |                |                 |   |                     |     |                                    |  |        |              |                                 |         |                     |        |           |  |        |      |                |                 |   |                     |     |                                    |  |          |              |                                 |         |                     |          |                          |  |          |
|                          | Cutting feed                                                                                                                                                                                                                                                                                                                                                                                                                                                                                                                                                                                                                                                                                                                                                                                                                                                                                                                                                                                                                                                                                                                                                                                                                                                                                                                                                                                                                                                                                                                                                                                                                                                                                                                                   | Rotary axis independent command | deg/min      |  |              |        |                |                 |   |                     |     |                                    |  |        |              |                                 |         |                     |        |           |  |        |      |                |                 |   |                     |     |                                    |  |          |              |                                 |         |                     |          |                          |  |          |
|                          |                                                                                                                                                                                                                                                                                                                                                                                                                                                                                                                                                                                                                                                                                                                                                                                                                                                                                                                                                                                                                                                                                                                                                                                                                                                                                                                                                                                                                                                                                                                                                                                                                                                                                                                                                | Feed per revolution             | inch/min     |  |              |        |                |                 |   |                     |     |                                    |  |        |              |                                 |         |                     |        |           |  |        |      |                |                 |   |                     |     |                                    |  |          |              |                                 |         |                     |          |                          |  |          |
| Any other than the above |                                                                                                                                                                                                                                                                                                                                                                                                                                                                                                                                                                                                                                                                                                                                                                                                                                                                                                                                                                                                                                                                                                                                                                                                                                                                                                                                                                                                                                                                                                                                                                                                                                                                                                                                                | inch/min                        |              |  |              |        |                |                 |   |                     |     |                                    |  |        |              |                                 |         |                     |        |           |  |        |      |                |                 |   |                     |     |                                    |  |          |              |                                 |         |                     |          |                          |  |          |
| (8) Cycle time display   | <p>This area displays the automatic operation time and cycle time.<br/>                     The display item can be switched in the integrated time window.</p> <ul style="list-style-type: none"> <li>♦DAT: Date</li> <li>♦TIM: Time</li> <li>♦PON: Power ON</li> <li>♦OP: Automatic operation</li> <li>♦STL: Automatic start</li> <li>♦EX1: Ext time1</li> <li>♦EX2: Ext time2</li> <li>♦CYC: Cycle time</li> </ul>                                                                                                                                                                                                                                                                                                                                                                                                                                                                                                                                                                                                                                                                                                                                                                                                                                                                                                                                                                                                                                                                                                                                                                                                                                                                                                                          |                                 |              |  |              |        |                |                 |   |                     |     |                                    |  |        |              |                                 |         |                     |        |           |  |        |      |                |                 |   |                     |     |                                    |  |          |              |                                 |         |                     |          |                          |  |          |
| (9) Control mode display | <p>This area displays the NC control mode.</p> <ul style="list-style-type: none"> <li>♦ISM: Inclined surface machining</li> <li>♦HTP: High-speed synchronous tapping</li> <li>♦TCP: Tool center point control</li> <li>♦MOR: Manual arbitrary reverse run mode</li> <li>♦MC1 to MC9: Machining condition selection (*3)</li> <li>♦HA1: High-speed high-accuracy control II (G5P10000)</li> <li>♦HA2: High-speed high-accuracy control III (G5P20000)</li> <li>♦SSS: SSS control</li> <li>♦CSC: Corner smooth control</li> <li>♦VAC: Variable-acceleration pre-interpolation acceleration/deceleration</li> <li>♦EAC: Allowable acceleration for each axis (*4)</li> <li>♦SFR: Smooth fairing</li> <li>♦FRG: Fairing</li> <li>♦SXF: Selection of axis for feedrate command</li> </ul> <p>Up to six control modes are displayed beginning at the top.</p>                                                                                                                                                                                                                                                                                                                                                                                                                                                                                                                                                                                                                                                                                                                                                                                                                                                                                        |                                 |              |  |              |        |                |                 |   |                     |     |                                    |  |        |              |                                 |         |                     |        |           |  |        |      |                |                 |   |                     |     |                                    |  |          |              |                                 |         |                     |          |                          |  |          |

| Display items                                                                                           | Details                                                                                                                                                                                                                                                                                                                                                                                                                                                                                                                                                                                                                                                                                                                                                                                                                                                                            |
|---------------------------------------------------------------------------------------------------------|------------------------------------------------------------------------------------------------------------------------------------------------------------------------------------------------------------------------------------------------------------------------------------------------------------------------------------------------------------------------------------------------------------------------------------------------------------------------------------------------------------------------------------------------------------------------------------------------------------------------------------------------------------------------------------------------------------------------------------------------------------------------------------------------------------------------------------------------------------------------------------|
| (10) G modal simple display                                                                             | This area displays the following modal status. Display format varies depending on the status of G code group 24. <ul style="list-style-type: none"> <li>♦G command modal status of G code group 1</li> <li>♦G command modal status of G code group 3</li> <li>♦Currently selected workpiece coordinate system offset</li> <li>♦Tool radius compensation modal, compensation number, tool shape amount, and tool radius wear</li> <li>♦Tool length compensation modal, compensation axis name, compensation number, tool shape amount, and tool length wear</li> </ul>                                                                                                                                                                                                                                                                                                              |
| (11) M and B commands                                                                                   | This area displays the command value for each of the M (miscellaneous function command value) and B (2nd miscellaneous function command value) functions.<br><In 1-part system display><br>The M (miscellaneous function command value) and B (2nd miscellaneous function command value) displays vary depending on the values of the parameters "#12005 Mfig" and "#1170 M2name".                                                                                                                                                                                                                                                                                                                                                                                                                                                                                                 |
| (12) M, S, T, and B commands<br>(2-part system/3-part simultaneous display)                             | Using the menu [MST Chg] allows you to switch the MSTB display in the area to be operated. (For details, refer to "Changing MSTB display" in "10.2.5 Operation of 2-part/3-part/4-part System Simultaneous Display".)                                                                                                                                                                                                                                                                                                                                                                                                                                                                                                                                                                                                                                                              |
| (13) M, T, and B commands (15-type/19-type)<br>(2-part system/3-part simultaneous display)              | This area displays the command value for each of the M (miscellaneous function command value), T, and B (2nd miscellaneous function command value) functions.<br>The M (miscellaneous function command value) and B (2nd miscellaneous function command value) displays vary depending on the values of the parameters "#12005 Mfig" and "#1170 M2name".                                                                                                                                                                                                                                                                                                                                                                                                                                                                                                                           |
| (14) Spindle rotation speed display<br>(2-part system/3-part system/4-part system simultaneous display) | This area displays the spindle rotation speed and the spindle command value that are designated in the parameters "#8925 to #8928" ("SP on 1st part sys" to "SP on 4th part sys") and "#8958 to #8961" ("SP on 5th part sys" to "SP on 8th part sys").                                                                                                                                                                                                                                                                                                                                                                                                                                                                                                                                                                                                                             |
| (15) Workpiece machining count display                                                                  | This area displays the current number of workpiece machining.<br>The display varies depending on the setting of the parameter #8001 to #8003.<br>However, when the parameter "#8001 WRK COUNT M" is set to "0", the number of workpiece machining is not counted, and it is not displayed on the screen.<br>The setting value of the parameter "#8001 WRK COUNT M" is displayed up to high-order two digits.                                                                                                                                                                                                                                                                                                                                                                                                                                                                       |
| (16) Selective display area                                                                             | This area displays NC data that is selected in the parameter "#8940 Set select display".<br>Depending on the selected NC data, you can press the  ,  , [↑], [↓], [←], [→], [↔], or [←] key to scroll pages.<br>Pressing the [INPUT] key displays the window that allows you to operate NC data displayed in the selective display area.<br>The selective display area is displayed on the monitor screen (normal view), monitor screen (single counter) (15-type/19-type), monitor screen (dual counter) (15-type/19-type), or monitor screen (quad counter) (15-type/19-type).<br>In 8.4 type/10.4 type, the monitor screen can be switched when the parameter "#8973 Selective display" is set to "1". |
| (17) Rate display (15-type/19-type)                                                                     | The upper side displays the execution position in the main program in percentage (rate) when the entire size of the currently executed main program is assumed to be 100%. The lower side displays the execution position in the sub program in percentage (rate) when the entire size of the currently executed sub program is assumed to be 100%.                                                                                                                                                                                                                                                                                                                                                                                                                                                                                                                                |

(\*1) If the program number (program name) exceeds the number of digits that can be displayed, the last digit is indicated by an asterisk (\*).

The device name displays the device name detected by operation search. However, "232C" is displayed at computer link B even if no operation search is carried out.

If the sequence number exceeds six digits, only the low-order six digits are displayed.

(\*2) If the data of the designated tool number has not been registered on the tool management screen, the tool icon is not displayed.

(\*3) During the machining condition selection, the following is displayed according to G command or the selected application and condition.

|     | Use                     | Condition   | G command    |
|-----|-------------------------|-------------|--------------|
| MC1 | Machining application 1 | Condition 1 | G120.1 P1 Q1 |
| MC2 | Machining application 1 | Condition 2 | G120.1 P1 Q2 |
| MC3 | Machining application 1 | Condition 3 | G120.1 P1 Q3 |
| MC4 | Machining application 2 | Condition 1 | G120.1 P2 Q1 |
| MC5 | Machining application 2 | Condition 2 | G120.1 P2 Q2 |
| MC6 | Machining application 2 | Condition 3 | G120.1 P2 Q3 |
| MC7 | Machining application 3 | Condition 1 | G120.1 P3 Q1 |
| MC8 | Machining application 3 | Condition 2 | G120.1 P3 Q2 |
| MC9 | Machining application 3 | Condition 3 | G120.1 P3 Q3 |

(\*4) When the variable-acceleration pre-interpolation acceleration/deceleration is enabled, the allowable acceleration speed for each axis is always enabled, and "EAC" is not displayed while the control mode "VAC" is being displayed.

#### Sub-menus displayed by pressing the menu [Dsp sw.]

Sub-menus displayed by pressing the menu [Dsp sw.], when 2-part system simultaneous view is invalid (#11019=0) with 8.4-type or 10.4-type.

| Menus       | Details                                         |
|-------------|-------------------------------------------------|
| Normal view | Switches the display format to the normal view. |
| Simple view | Switches the display format to the simple view. |
| Counter #1  | Switches counter type 1. (*1)                   |
| Counter #2  | Switches counter type 2. (*1) (*2)              |
| Counter #3  | Switches counter type 3. (*1)                   |
| Counter #4  | Switches counter type 4. (*1) (*2)              |
| Counter #5  | Switches counter type 5. (*3)                   |

(\*1) This menu cannot be operated in simple view mode.

(\*2) This menu cannot be operated in normal view mode (6 axes or more).

(\*3) This menu cannot be operated in normal view mode.

#### Note

(1) The selected display format is also held when the power is turned on again.

Sub-menus displayed by pressing the menu [Dsp sw.], when 2-part system simultaneous view is invalid (#11019=0) with 15-type or 19-type

| Menus          | Details                                        |
|----------------|------------------------------------------------|
| Single counter | Switches the display format to single counter. |
| Dual counter   | Switches the display format to dual counter.   |
| Quad counter   | Switches the display format to quad counter.   |
| Counter #1     | Switches counter type 1. (*1)                  |
| Counter #2     | Switches counter type 2. (*1) (*2)             |
| Counter #3     | Switches counter type 3. (*1)                  |
| Counter #4     | Switches counter type 4. (*1) (*2)             |
| Counter #5     | Switches counter type 5. (*2) (*3)             |

(\*1) This menu cannot be operated in single counter mode.

(\*2) This menu cannot be operated in dual counter mode.

(\*3) This menu cannot be operated in quad counter mode.

### Note

(1) The selected display format is also held when the power is turned on again.

Sub-menus displayed by pressing the menu [Dsp sw.], when 2-part/3-part/4-part system simultaneous display is valid (#11019 = 1 to 4)

| Menus          | Details                                                                                                                                                                  |
|----------------|--------------------------------------------------------------------------------------------------------------------------------------------------------------------------|
| Counter expand | Switches the counter display format to counter1 (expand).                                                                                                                |
| Dual counter   | Switches the counter display format to dual counter.                                                                                                                     |
| Quad counter   | Switches the counter display format to quad counter.                                                                                                                     |
| MSTB view      | Switches the MSTB display for the area to be operated.<br>This menu cannot be operated for 2-part or 4-part system simultaneous display on 15-type/19-type display unit. |
| Counter #1     | Switches counter type 1.                                                                                                                                                 |
| Counter #2     | Switches counter type 2. (*1) (*2)                                                                                                                                       |
| Counter #3     | Switches counter type 3. (*1) (*3)                                                                                                                                       |
| Counter #4     | Switches counter type 4. (*1) (*3)                                                                                                                                       |

(\*1) This menu cannot be operated in single counter mode.

(\*2) This menu may not be able to be operated in dual counter mode depending on the number of displayed axes.

(\*3) This menu cannot be operated in dual counter mode.

### Note

(1) The selected display format is also held when the power is turned on again.

## 10.2.2 Switching the Display Format



The monitor screen display format can be switched using the menu [Dsp sw.]. The switchable display format varies depending on the value of the parameter "#11019 2-system display".

- (1) In the 1-part system display (#11019 = 0), switch the display format between the normal view and simple view or among single counter, dual counter, and quad counter.
- (2) In the 2-part/3-part/4-part system simultaneous display (#11019 = 1 to 4), switch the display format among the counter1 (expand), dual counter and quad counter.

### Switching the normal view and simple view

When the parameter "#11019 2-system display" (2-part system simultaneous display) is disabled, you can press the sub menu [Normal view] or [Simple view] in the [Dsp sw.] to switch the screen to the normal view or simple view. In 15-type/19-type, the screen can be switched using the sub menu [Single counter], [Dual counter], or [Quad counter].

### Switching the Counter Display Format

When the parameter "#11019 2-system display" (2-part system simultaneous display) is enabled, the counter display format can be switched to the following three modes.

- Counter1 (expand): Displays one counter (Counter type 1) for each part system.
- Dual counter: Displays two counters (Counter types 1 and 2) for each part system.
- Quad counter: Displays four counters (Counter types 1 to 4) for each part system.

### Note

- (1) For details on the screen image, refer to Screens 9 to 19 in "10.2.1 Screen Layout".  
You can press the sub-menu [Counterexpand], [Dual counter], or [Quad counter] in the menu [Dsp sw.] to switch the display format.



10.2.3 Switching the Counter Types



The counter mode on the monitor screen (monitor screen (normal view), monitor screen (simple view), and 2-part/3-part/4-part system simultaneous display screen) can be switched using the parameter or the menu [Counter].

- (1) Switching the counter type in the parameter setting
- (2) Switching the counter type in the menu [Counter]

**Switching in the parameter setting**

The type of the counter to be displayed on the monitor screen can be switched using each of the counter type parameters "#8901" to "#8905". The figure below shows the relationship between counters and parameters using arrows.

<Monitor screen (Normal view)>

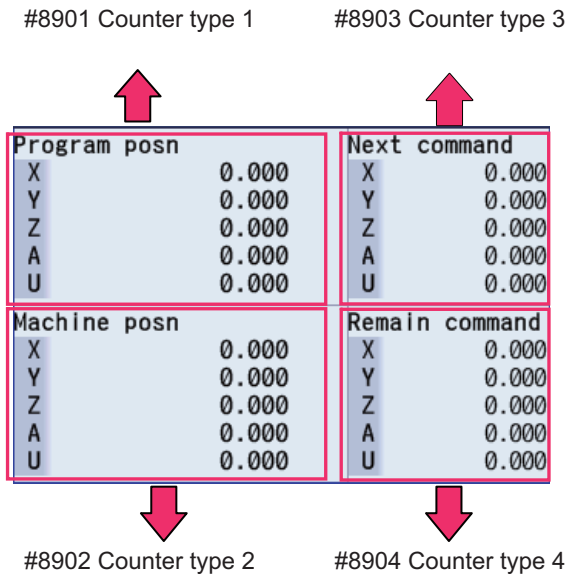

<Monitor screen (Simple view)>

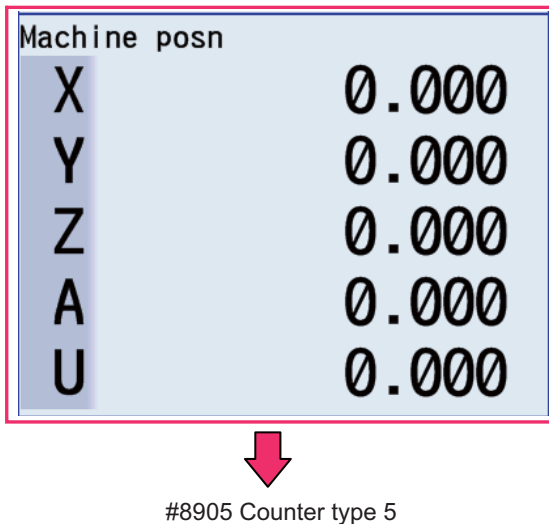

<Monitor screen (Single counter) (15-type/19-type)>

|      |                     |
|------|---------------------|
| Work | G54                 |
| X1   | Ø-12345.123456789#1 |
| Z1   | 0.000000000#1       |
| Y1   | 0.000000000#1       |
| C1   | 0.000000000#1       |
| B1   | 0.000000000#1       |



#8905 Counter type 5

<Monitor screen (Dual counter) (15-type/19-type)>

|               |                     |              |               |
|---------------|---------------------|--------------|---------------|
| Relative posn |                     | Machine posn |               |
| X1            | Ø-12345.000000000 [ | X1           | -12345.000000 |
| Z1            | 0.000000000 [       | Z1           | 0.000000      |
| Y1            | 0.000000000 [       | Y1           | 0.000000      |
| C1            | 0.000000000 [       | C1           | 0.000000      |
| B1            | 0.000000000 [       | B1           | 0.000000      |
| V1            | -12345.000000000 [  | V1           | -12345.000000 |
| H1            | 0.000000000 [       | H1           | 0.000000      |
| A1            | 0.000000000 [       | A1           | 0.000000      |



#8901 Counter type 1



#8903 Counter type 3

<Monitor screen (Quad counter) (15-type/19-type)>

#8901 Counter type 1

#8903 Counter type 3



|               |          |                |       |
|---------------|----------|----------------|-------|
| Relative posn |          | Machine posn   |       |
| X             | 0.000    | X              | 0.000 |
| Y             | 0.000    | Y              | 0.000 |
| Z             | 0.000    | Z              | 0.000 |
| C1            | 0.000] [ | C1             | 0.000 |
| A1            | 0.000    | A1             | 0.000 |
| Work G54      |          | Remain command |       |
| X             | 0.000    | X              | 0.000 |
| Y             | 0.000    | Y              | 0.000 |
| Z             | 0.000    | Z              | 0.000 |
| C1            | 0.000] [ | C1             | 0.000 |
| A1            | 0.000    | A1             | 0.000 |



#8902 Counter type 2



#8904 Counter type 4

<Monitor screen (2-part/3-part/4-part system simultaneous display)>

The following counter type is displayed in the target operation area on the left.  
Also, the same counter type is displayed in the target operation area on the right.

■[Counterexpand]

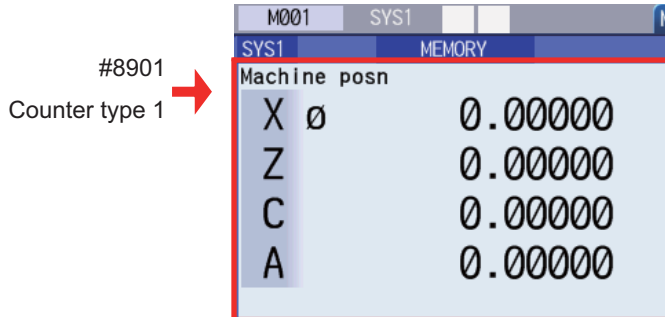

■[Dual counter]

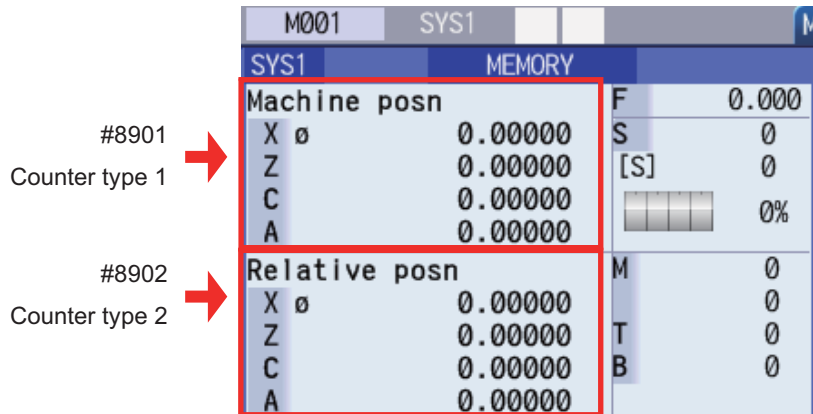

■[Quad counter](2-part/3-part system simultaneous display)

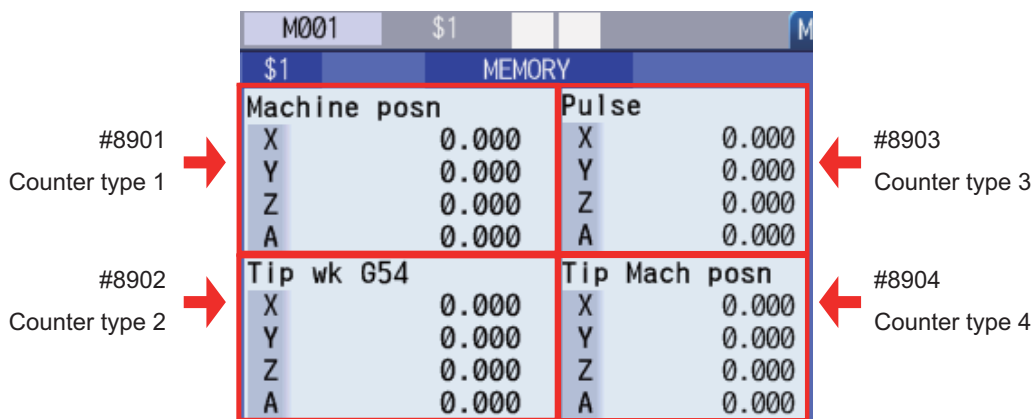

■[Quad counter] (4-part system simultaneous display)

|                         | SYS1                                                                                                    | MEMORY |
|-------------------------|---------------------------------------------------------------------------------------------------------|--------|
| #8901<br>Counter type 1 | <b>Relative posn</b><br>X1 0-1235.678901<br>Y1 0.000000<br>Z1 0.000000<br>C1 0.000000 [<br>A1 0.000000  |        |
| #8902<br>Counter type 2 | <b>Program posn</b><br>X1 0-1235.678901<br>Y1 0.000000<br>Z1 0.000000<br>C1 0.000000 [<br>A1 0.000000   |        |
| #8903<br>Counter type 3 | <b>Remain command</b><br>X1 0-1235.678901<br>Y1 0.000000<br>Z1 0.000000<br>C1 0.000000 [<br>A1 0.000000 |        |
| #8904<br>Counter type 4 | <b>Next command</b><br>X1 0-1235.678901<br>Y1 0.000000<br>Z1 0.000000<br>C1 0.000000 [<br>A1 0.000000   |        |

### Switching the counter type using the menu

The type of the counter to be displayed on the monitor screen can be changed using the sub-menu [Counter] under the menu [Dsp sw.]. If the counter type is switched using the menus [Counter #1] to [Counter #5], the values of the parameters "#8901 Counter type 1" to "#8905 Counter type 5" are rewritten.

However, when data protection is valid, the displayed counter type can be switched using the menu, but the value of each parameter cannot be rewritten. In this case, if the display returns to the monitor screen after switching to another screen while the displayed counter type is different from the parameter value, the displayed counter is set to the counter type that matches the parameter value.

The figure below shows the counter types that can be displayed using the menu [Counter] as well as the switching order.

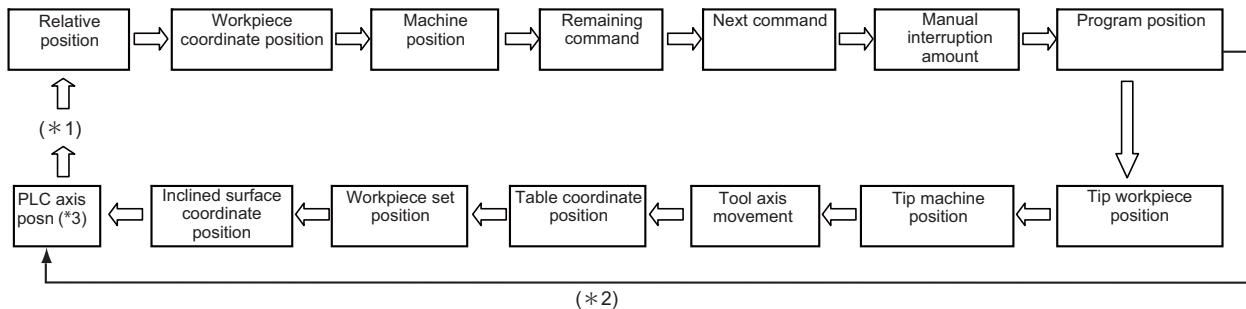

(\*1) If a counter other than the 14 types of counters above ("Relative position" to "Inclined surface coordinate position") is set to the parameter ("#8901 Counter type 1" to "#8905 Counter type 5") before the counter type is switched using the menu [Counter], the counter type is switched among 15 types of counters, including that counter. When the counter type is switched to a counter type other than the 14 counter types above, it is held until the power is turned OFF. Furthermore, if the 14 counter types above are designated in parameters before the counter type is switched using the menu, the counter type is switched among these 14 counter types.

(\*2) "Tip workpiece position", "Tip machine position", "Tool axis movement", "Table coordinate position", "Workpiece set position" and "Inclined surface coordinate position" counters can be switched when any of the following specifications is valid.

- Tool center point control
- Tool length compensation along the tool axis
- Tool handle feed & interruption
- Workpiece installation error compensation
- Inclined surface machining command
- Simple inclined surface machining command
- 3-dimensional tool radius compensation (tool's vertical-direction compensation)
- 3-dimensional manual feed
- R-Navi
- Program format switch

(\*3) When the parameter "#11091 PLC counter valid" is valid, it switches to [PLC Axis] counter. [PLC Axis] counter is common for part systems. Even when the displayed part system is switched, the value of [PLC Axis] is not changed. When the axis name of PLC axis is not set, the axis name of PLC axis counter is displayed as "P + axis No." (P1, P2, ...). The axis set to non-display axis by the parameter "#1069 no\_dsp" is not displayed.

The axis set by any of the following parameters is not displayed for switching.

- #1280 ext16/bit2 (Interchange coordinate position display)
- #1494 dsp\_ax\_change (Switching the counter display axis order)
- #1537 crsax[1] to #1544 crsax[8] (Axis interchange by mixed control function)

The axis set as the auxiliary axis by the parameter "#12800 chgauxno" is displayed in PLC axis counter.

### 10.2.4 Switching the Spindle No. to be Displayed on Counter



The number of counter axes that can be displayed on the monitor screen is as follows. To refer to the subsequent axes, select the menu [Next axis].



- Monitor screen in 1-part system view (normal view): Up to 10 axes
- Monitor screen in 1-part system view (simple view): Up to 5 axes
- 2-part system simultaneous view (Counter1 (expand)): Up to 4 axes
- 2-part system simultaneous view (Dual counter): Up to 8 axes
- 2-part system simultaneous view (Quad counter): Up to 4 axes
- 3-part system simultaneous view (Counter1 (expand)): Up to 5 axes
- 3-part system simultaneous view (Dual counter): Up to 10 axes
- 3-part system simultaneous view (Dual counter): Up to 5 axes

#### Note

- (1) When mixed synchronization control or arbitrary axis exchange control is enabled, the menu [Next axis] is displayed even if there is no axis to be switched.

### 10.2.5 Operation of 2-part/3-part/4-part System Simultaneous Display

#### Switching the area to be operated (right/left)

The area to be operated (right/left) can be switched by touching in the area using the tab key ( ) or on the touchscreen.

When the area to be operated is switched, the part system name to be operated is displayed on the selection bar. At NC startup, the left side is set as the area to be operated.

#### Note

- (1) The area to be operated cannot be switched while the pop-up window is being displayed.
- (2) The area to be operated can be switched while the software keyboard is being displayed.

#### Switching the display part system No.

The part system is switched for the area to be operated (right/left).

When the part system displayed in the non-target area is designated by incrementing displayed part systems by one each time you press the  key, the area to be operated is switched.

If the available number of displayed part systems is reached, the first part system is displayed.

#### Note

- (1) The same operation is also applied when you click a part system name in the selection bar on the touchscreen.
- (2) If the base common parameter "#11035 Sys. change limit" is set to "1", it disables part systems from being switched using the  key or on the touchscreen.

**Changing MSTB display**

On the monitor screen in 2-part/3-part system simultaneous view, you can press the [MST Chg] main menu to change the MSTB display for the area to be operated.

The MSTB display type is held for each part system when the screen is switched or the power is turned ON again.

<2-part system simultaneous view: Counter1 (expand) / Quad counter>

There are the following two types of MSTB displays, which are toggled each time the menu [MST Chg] is pressed.

- MSTB display type (\*1) (\*2) (\*3)

- MSTB + Workpiece machining count display type (\*1) (\*2)

(\*1) The S command is used to designate the spindle to be displayed for each part system using parameters (#8925 to #8928 ("SP on 1st part sys" to "SP on 4th part sys") and #8958 to #8961 ("SP on 5th part sys" to "SP on 8th part sys")). Up to two spindles can be designated in each part system. The M (miscellaneous function command value), T (tool command value), and B (2nd miscellaneous function command value) functions are displayed one by one regardless of the value of the parameter "#12005 Mfig" (M count), "#12009 Tfig" (T count), or "#12011 Bfig" (B count). However, the B (2nd miscellaneous function command value) function is displayed or hidden depending on the value of the parameter "#1170 M2name" (2nd miscellaneous code).

(\*2) The menu [MST Chg] is not available in the following cases:

- The parameter "#8001 WRK COUNT M" is set to "0".

- "F" is set to the low-order byte of parameters #8925 to #8928 ("SP on 1st part sys" to "SP on 4th part sys") and #8958 to #8961 ("SP on 5th part sys" to "SP on 8th part sys"), or the parameter "#1039 spinno" is set to "1".

(\*3) When the number of spindles is set to "1" or only one spindle is displayed depending on the operation parameters (#8925 to #8928 ("SP on 1st part sys" to "SP on 4th part sys") and #8958 to #8961 ("SP on 5th part sys" to "SP on 8th part sys")), the load meter of the target spindle is displayed at the position at which the second spindle is to be displayed.

<2-part/3-part system simultaneous display: Dual counter>

There are the following six types of MSTB displays, which are toggled each time the menu [MST Chg] is pressed.

- MSTB display type (\*1)

- S display type 1

- S display type 2

- MTB display type (2-part system simultaneous display only)

- MTB + Workpiece machining count display type

- MSTB + Workpiece machining count display type (\*1)

(\*1) When the number of spindles is set to "1" or only one spindle is displayed depending on the operation parameters (#8925 to #8928 ("SP on 1st part sys" to "SP on 4th part sys") and #8958 to #8961 ("SP on 5th part sys" to "SP on 8th part sys")), the load meter of the target spindle is displayed at the position at which the second spindle is to be displayed.

**Customizing the screen display (Select display area (parameter "#8973 Selective display" = "1"))**

A part of the monitor screen (normal view) can be customized to suit user's need (to display data which a user always needs to refer to). The select display area shows the screen that is selected using the parameter "#8940 Set select display".

10.2.6 Counter All-axis Display



A counter for all axes opens as a pop-up display.  
The type of displayed counter can be selected with the menu.

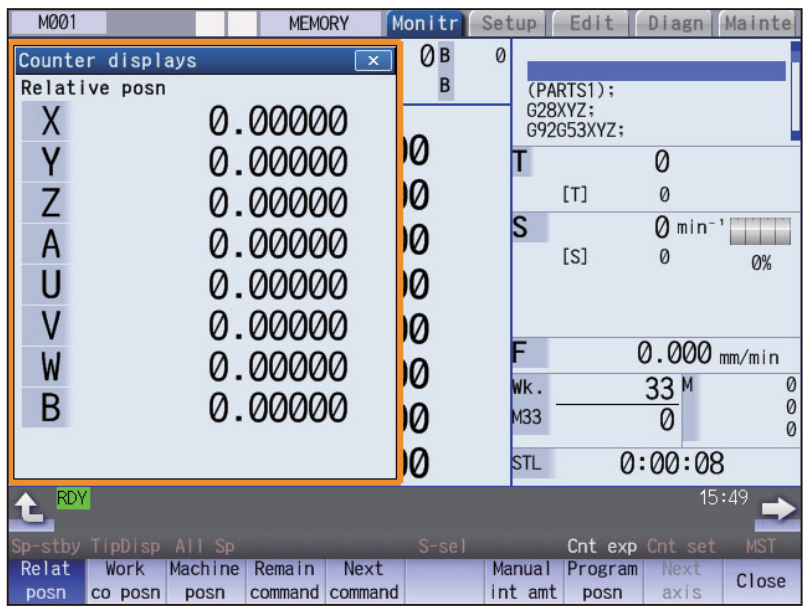

**Menus**

| Menus          | Details                                                                                                                                                                                                                                                                               |
|----------------|---------------------------------------------------------------------------------------------------------------------------------------------------------------------------------------------------------------------------------------------------------------------------------------|
| Relat posn     | This displays the currently executed position.                                                                                                                                                                                                                                        |
| Work co posn   | This displays the G54 to G59 workpiece coordinate system modal No. and the workpiece coordinate position in that workpiece coordinate system.                                                                                                                                         |
| Machine posn   | This displays the coordinate position of each axis in the basic machine coordinate system having a characteristic position, specified by the machine, as a zero point.                                                                                                                |
| Remain command | This displays the remaining distance of the movement command being executed during automatic start or automatic halt. (The remaining distance is the incremental distance from the current position to the end point of that block.)                                                  |
| Next command   | This displays the details of the command in the block executed after the block currently being executed.                                                                                                                                                                              |
| Manual int amt | This displays the amount moved with the manual mode while the manual absolute switch was OFF. When the parameter "# 8173 Hold intr amount" is set to "0", interrupt amount is cleared by pressing the reset button.                                                                   |
| Program posn   | This displays the value obtained by subtracting the tool compensation amount compensated for that axis from the position actually being executed for each axis. When the parameter "# 8173 Hold intr amount" is set to "0", interrupt amount is cleared by pressing the reset button. |
| Close          | This closes the pop-up window and quits this function.                                                                                                                                                                                                                                |
| Tip wk posn    | This displays the position of the tool center from the workpiece coordinate reference position in the selected workpiece coordinate system.                                                                                                                                           |



| Menus           | Details                                                                                                                                                                                                                                                                                            |
|-----------------|----------------------------------------------------------------------------------------------------------------------------------------------------------------------------------------------------------------------------------------------------------------------------------------------------|
| Tip machine     | This displays the position of the tool center from the machine coordinate system reference position in the machine coordinate system.                                                                                                                                                              |
| Pulse           | This displays the amount moved in the selected axis direction using the manual pulse generator in the hypothetical machine coordinate system.<br>Basically this is updated only when manual ABS is OFF. If "#7905 NO_ABS" is set to "1", this will be updated regardless of the manual ABS ON/OFF. |
| Table co posn   | This displays the table coordinate.                                                                                                                                                                                                                                                                |
| Wk Comp co posn | This displays the workpiece installation position coordinate.                                                                                                                                                                                                                                      |
| Incline co posn | This displays the inclined surface coordinate.                                                                                                                                                                                                                                                     |
| PLC Axis        | This displays the machine position of PLC axis.                                                                                                                                                                                                                                                    |
| Next axis       | This switches the axis to be displayed on the counter. This switches the axes to be displayed on the counter between "1st axis to 12th axis" and "13th axis or after".                                                                                                                             |

### Note

- (1) The type of counter displayed first when the pop-up display appears is the relative position.  
However, when any of the targeted specifications (\*1) is valid, "Tip workpiece position" is displayed. The counter which appears next is the type selected previously.
- (2) The menus [Tip wk posn], [Tip machine], [Pulse] and [Table co posn] appear when any of the targeted specifications (\*1) is valid.
- (3) The menu [Wk Comp co posn] is displayed when the workpiece installation error compensation specification is ON.
- (4) The menu [Incline co posn] is displayed when any of the specifications (inclined surface machining command, simple inclined surface machining command or R-Navi) is valid.
- (5) The menu [PLC Axis] is displayed when the parameter "#11091 PLC counter valid" is valid.  
When the axis name of PLC axis is not set, the axis name of PLC axis counter is displayed as "P + axis No." (P1, P2, ...).  
The axis set to the axis with no display in the parameter "#1069 no\_dsp" is not displayed.  
The axis set by any of the following parameters is not displayed for switching.
  - #1280 ext16/bit2 (Interchange coordinate position display)
  - #1494 dsp\_ax\_change (Switching the counter display axis order)
  - #1537 crsax[1] to #1544 crsax[8] (Axis interchange by mixed control function)
 The axis set as the auxiliary axis by the parameter "#12800 chgauxno" is displayed in PLC axis counter.

#### (\*1) Targeted specifications

- Tool center point control
- Tool length compensation along the tool axis
- Tool handle feed & interruption
- Workpiece installation error compensation
- Inclined surface machining command
- Simple inclined surface machining command
- 3-dimensional tool radius compensation (tool's vertical-direction compensation)
- 3-dimensional manual feed
- R-Navi

10.2.7 Modal Display



The state of each modal during automatic operation is displayed.  
 The displayed details differ for the M system and L system.

<M system>

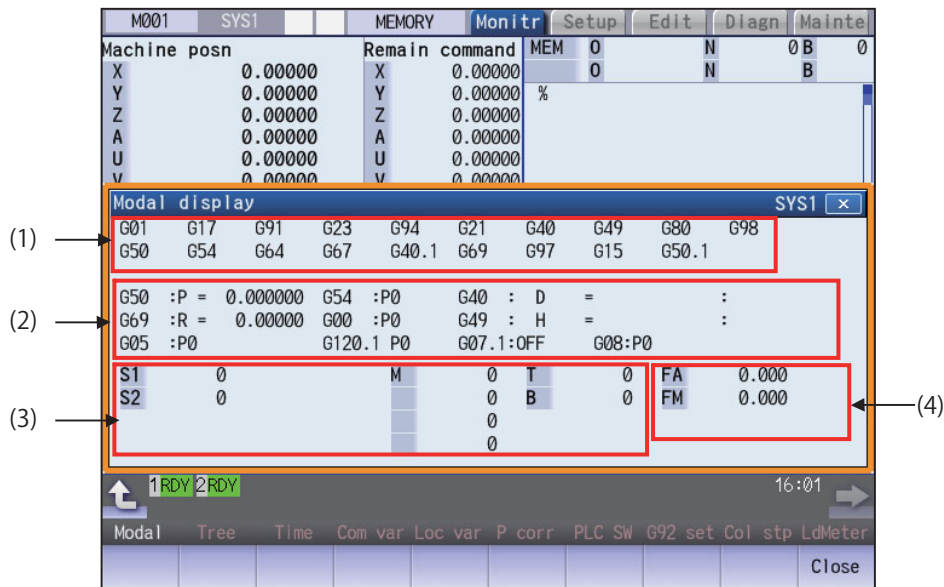

Even if operating area is switched in the 2-part system simultaneous display, the position of the pop-up window will not change. It is always displayed at the bottom of the screen.

**Display items**

| Display items    | Details                                                                                                                                                                                                                                                                                                                                                                                                                                                                                                                                                     |
|------------------|-------------------------------------------------------------------------------------------------------------------------------------------------------------------------------------------------------------------------------------------------------------------------------------------------------------------------------------------------------------------------------------------------------------------------------------------------------------------------------------------------------------------------------------------------------------|
| (1) G modal list | <p>The list below shows the G command modal status of the currently executed groups 1 to 20 or group 24.</p> <p>Each item displays the following information.</p> <p>G00: Displays the G command modal status of the currently executed group 1.<br/>                     G17: Displays the G command modal status of the currently executed group 2.<br/>                     : Displays the G command modal status of each group in sequence.<br/>                     G50.1: Displays the G command modal status of the currently executed group 19.</p> |

| Display items                                                                                                  | Details                                                                                                                                                                                                             |
|----------------------------------------------------------------------------------------------------------------|---------------------------------------------------------------------------------------------------------------------------------------------------------------------------------------------------------------------|
| (2) Details of G modal                                                                                         | This item displays detailed information of the G command modal status of the currently executed group.<br>Each item displays the following information.                                                             |
| G50 :P= 0.000000                                                                                               | Scaling factor                                                                                                                                                                                                      |
| G54.1:P1                                                                                                       | Workpiece coordinate system offset No.                                                                                                                                                                              |
| G42 : D 10= 0.000000: 0.000000<br>G42:<br>D10:<br>= 0.000000:<br>0.000000                                      | Tool radius compensation modal<br>Offset num<br>Shape compensation amount of tool radius<br>Tool radius wear amount                                                                                                 |
| G69 :R = 0.000                                                                                                 | Coordinate rotation angle<br>(Displayed in the range of $\pm 360^\circ$ .)                                                                                                                                          |
| G54.4:P1                                                                                                       | Workpiece installation error compensation No.                                                                                                                                                                       |
| G43 :ZH 50= 0.000000: 0.000000<br>G43:<br>Z<br>H50<br>= 0.000000:<br>0.000000                                  | Tool length compensation modal<br>Compensation axis name<br>Offset num<br>Offset<br>Tool length wear amount                                                                                                         |
| G43 :ZH 50= 0.000000: 0.000000<br>G43:<br>Z<br>H50<br>= 0.000000:<br>0.000000                                  | Tool length compensation modal<br>Compensation axis name<br>Offset num<br>Offset<br>Tool length wear amount                                                                                                         |
| G05.1:P1000<br>(Display example)<br>G05 :P0<br>G05.1: Q1<br>G05.1: Q2<br>G05 :P10000<br><br>G05 :P1<br>G05 :P2 | High-speed machining mode<br>High-speed high-accuracy control I<br>Spline interpolation<br>High-speed high-accuracy control II (SSS control OFF)<br><br>High-speed machining mode I<br>High-speed machining mode II |
| VAC<br><br>CSC<br>SFR<br>SSS (*1)                                                                              | Variable-acceleration pre-interpolation acceleration/<br>deceleration enabled<br><br>Corner smooth control enabled<br>Smooth fairing ON<br>SSS enabled                                                              |
| G120.1 P1 Q1<br>(Display example)<br>G120.1 P0<br>G120.1 P1 Q2 (*2)                                            | Machining Condition Selection I<br><br>Reference parameter selected<br>Each machining condition parameter selected<br>Pn: (n=1 to 3) Machining purpose<br>Qm: (m=1 to 3) Condition                                  |
| G07.1: ON<br>G07.1: OFF                                                                                        | Cylindrical interpolation modal (Fixed to G07.1)<br>Cylindrical interpolation mode (ON/OFF)                                                                                                                         |
| G08: P0<br>G08: P1                                                                                             | High-accuracy control mode OFF<br>High-accuracy control mode ON                                                                                                                                                     |

| Display items            | Details                                                                                                                                                                                                                                                                                                                                                                                                                                                                                                                                                                                                                                                                                                                                                                                                                                                                                                                                                                |
|--------------------------|------------------------------------------------------------------------------------------------------------------------------------------------------------------------------------------------------------------------------------------------------------------------------------------------------------------------------------------------------------------------------------------------------------------------------------------------------------------------------------------------------------------------------------------------------------------------------------------------------------------------------------------------------------------------------------------------------------------------------------------------------------------------------------------------------------------------------------------------------------------------------------------------------------------------------------------------------------------------|
| (3) MSTB display area    | <p>This area displays the program command modal value for each of the currently executed commands.</p> <p>Each item displays the following information.</p> <ul style="list-style-type: none"> <li>♦S command</li> <li>♦M command</li> <li>♦T command</li> <li>♦2nd miscellaneous function (B) command</li> </ul> <p>The number of S displays varies depending on the value of the parameter "#1039 spinno" (Number of spindles).</p> <p>The number of M displays varies depending on the value of the parameter "#12005 Mfig" (M count).</p> <p>The number of T or B displays is set to "1" regardless of the value of the parameters "#12009 Tfig" (T count) and "#12011 Bfig" (B count). However, for the B display, the value is displayed or hidden depending on the value of the parameter (#1170 M2name 2nd miscellaneous code).</p> <p>For the T display, only the tool number is displayed regardless of the value of the parameter "#11038 T disp type".</p> |
| (4) F modal display area | <p>This area displays the F modal value and manual feedrate.</p> <p>FA: Displays the program command F modal value of the currently executed command.</p> <p>FM: Displays the manual feedrate.</p>                                                                                                                                                                                                                                                                                                                                                                                                                                                                                                                                                                                                                                                                                                                                                                     |

(\*1) Displays the current control mode. When multiple control modes are enabled simultaneously, one of them is displayed in the order in which the priority is higher. (The priority is higher beginning at the top.)

(\*2) G121 command: Machining Condition Selection I Cancel

Changes to the machining condition selection command that is selected in [Setup] - [MacCond] screen.

<L system>

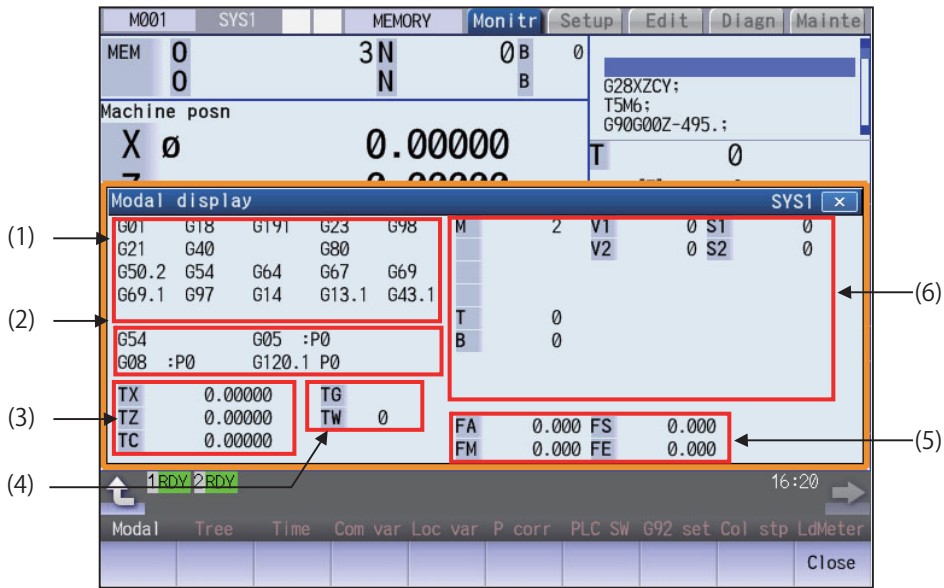

Even if operating area is switched in the 2-part system simultaneous display, the position of the pop-up window will not change. It is always displayed at the bottom of the screen.

**Display items**

| Display items    | Details                                                                                                                                                                                                                                                                                                                                                                                                                                                                                                                                                          |
|------------------|------------------------------------------------------------------------------------------------------------------------------------------------------------------------------------------------------------------------------------------------------------------------------------------------------------------------------------------------------------------------------------------------------------------------------------------------------------------------------------------------------------------------------------------------------------------|
| (1) G modal list | <p>The list below shows the G command modal status of the currently executed groups 1 to 20 or group 24 (*1).</p> <p>Each item displays the following information.</p> <p>G00: Displays the G command modal status of the currently executed group 1.<br/>                     G17: Displays the G command modal status of the currently executed group 2.<br/>                     : Displays the G command modal status of each group in sequence.<br/>                     G43.1: Displays the G command modal status of the currently executed group 19.</p> |

| Display items                                             | Details                                                                                                                                                                                                                                                                                                                                                                                                                                                                                                                                                                                                                                                                                                                                                                                                                                                                                                                                                                                                                                                                                                                                                                                                                                                                                                                                                                                                                                                                                                                                                                                                                                                                                                                                                                                                                                                                                                                                                                                                                                                                                                                                                                                                                                                                                                                                                                                                                                                                                                                                                                                                                                                                                                                                                                                                                                                                                                                                                                                                                                                                                                                                                                                                                                                                          |           |                                        |                        |                                                                                                                                                                                                                                                                                        |                              |                                                                                                                                                          |         |     |         |                                |         |                                 |           |                                        |           |                                       |             |                                        |        |                        |     |                                                                           |     |                               |     |                   |     |             |        |                                |        |                               |                                   |                                 |           |                              |                   |                                                                                                             |
|-----------------------------------------------------------|----------------------------------------------------------------------------------------------------------------------------------------------------------------------------------------------------------------------------------------------------------------------------------------------------------------------------------------------------------------------------------------------------------------------------------------------------------------------------------------------------------------------------------------------------------------------------------------------------------------------------------------------------------------------------------------------------------------------------------------------------------------------------------------------------------------------------------------------------------------------------------------------------------------------------------------------------------------------------------------------------------------------------------------------------------------------------------------------------------------------------------------------------------------------------------------------------------------------------------------------------------------------------------------------------------------------------------------------------------------------------------------------------------------------------------------------------------------------------------------------------------------------------------------------------------------------------------------------------------------------------------------------------------------------------------------------------------------------------------------------------------------------------------------------------------------------------------------------------------------------------------------------------------------------------------------------------------------------------------------------------------------------------------------------------------------------------------------------------------------------------------------------------------------------------------------------------------------------------------------------------------------------------------------------------------------------------------------------------------------------------------------------------------------------------------------------------------------------------------------------------------------------------------------------------------------------------------------------------------------------------------------------------------------------------------------------------------------------------------------------------------------------------------------------------------------------------------------------------------------------------------------------------------------------------------------------------------------------------------------------------------------------------------------------------------------------------------------------------------------------------------------------------------------------------------------------------------------------------------------------------------------------------------|-----------|----------------------------------------|------------------------|----------------------------------------------------------------------------------------------------------------------------------------------------------------------------------------------------------------------------------------------------------------------------------------|------------------------------|----------------------------------------------------------------------------------------------------------------------------------------------------------|---------|-----|---------|--------------------------------|---------|---------------------------------|-----------|----------------------------------------|-----------|---------------------------------------|-------------|----------------------------------------|--------|------------------------|-----|---------------------------------------------------------------------------|-----|-------------------------------|-----|-------------------|-----|-------------|--------|--------------------------------|--------|-------------------------------|-----------------------------------|---------------------------------|-----------|------------------------------|-------------------|-------------------------------------------------------------------------------------------------------------|
| (2) Details of G modal                                    | <p>This item displays detailed information of the G command modal status of the currently executed group.<br/>Each item displays the following information.</p> <table border="1" data-bbox="512 331 1442 371"> <tr> <td>G54.1:P10</td> <td>Workpiece coordinate system offset No.</td> </tr> </table> <p>The data format of the workpiece coordinate system offset number is as follows:</p> <table border="1" data-bbox="512 412 1442 685"> <tr> <td>G5x :P<br/>(x = 4 to 9)</td> <td>G54 Workpiece coordinate system selection 1<br/>G55 Workpiece coordinate system selection 2<br/>G56 Workpiece coordinate system selection 3<br/>G57 Workpiece coordinate system selection 4<br/>G58 Workpiece coordinate system selection 5<br/>G59 Workpiece coordinate system selection 6</td> </tr> <tr> <td>G54.1: Pyy<br/>(yy = 1 to 96)</td> <td>G54.1 Workpiece coordinate system selection<br/>The number of extension sets is assigned to 0, 48, or 96 sets depending on the additional specifications.</td> </tr> </table> <p>When the high-speed machining mode, high-speed high-accuracy control, or direct command mode specification is enabled, the status of the high-speed machining mode, high-speed high-accuracy control, or direct command mode is displayed.</p> <table border="1" data-bbox="512 786 1442 1043"> <tr> <td>G05 :P0</td> <td>OFF</td> </tr> <tr> <td>G05 :P1</td> <td>High-speed machining mode I ON</td> </tr> <tr> <td>G05 :P2</td> <td>High-speed machining mode II ON</td> </tr> <tr> <td>G05.1: Q0</td> <td>High-speed high-accuracy control I OFF</td> </tr> <tr> <td>G05.1: Q1</td> <td>High-speed high-accuracy control I ON</td> </tr> <tr> <td>G05 :P10000</td> <td>High-speed high-accuracy control II ON</td> </tr> <tr> <td>G05 P4</td> <td>Direct command mode ON</td> </tr> </table> <p>Displays the current control mode.<br/>When multiple control modes are enabled simultaneously, one of them is displayed in the order in which the priority is higher.<br/>(The priority is higher beginning at the top.)</p> <table border="1" data-bbox="512 1173 1442 1346"> <tr> <td>VAC</td> <td>Variable-acceleration pre-interpolation acceleration/deceleration enabled</td> </tr> <tr> <td>CSC</td> <td>Corner smooth control enabled</td> </tr> <tr> <td>SFR</td> <td>Smooth fairing ON</td> </tr> <tr> <td>SSS</td> <td>SSS enabled</td> </tr> </table> <p>When the high-accuracy control specification is enabled, the status of the high-accuracy control mode is displayed.</p> <table border="1" data-bbox="512 1420 1442 1487"> <tr> <td>G08:P0</td> <td>High-accuracy control mode OFF</td> </tr> <tr> <td>G08:P1</td> <td>High-accuracy control mode ON</td> </tr> </table> <p>Displays the currently selected machining condition parameter group.<br/>* If the reference parameter is selected, "G120.1 P0" is displayed.</p> <table border="1" data-bbox="512 1559 1442 1765"> <tr> <td>G120.1 P1 Q2<br/>(Display example)</td> <td>Machining Condition Selection I</td> </tr> <tr> <td>G120.1 P0</td> <td>Reference parameter selected</td> </tr> <tr> <td>G120.1 P1 Q1 (*2)</td> <td>Each machining condition parameter selected<br/>Pn: (n=1 to 3) Machining purpose<br/>Qm: (m=1 to 3) Condition</td> </tr> </table> | G54.1:P10 | Workpiece coordinate system offset No. | G5x :P<br>(x = 4 to 9) | G54 Workpiece coordinate system selection 1<br>G55 Workpiece coordinate system selection 2<br>G56 Workpiece coordinate system selection 3<br>G57 Workpiece coordinate system selection 4<br>G58 Workpiece coordinate system selection 5<br>G59 Workpiece coordinate system selection 6 | G54.1: Pyy<br>(yy = 1 to 96) | G54.1 Workpiece coordinate system selection<br>The number of extension sets is assigned to 0, 48, or 96 sets depending on the additional specifications. | G05 :P0 | OFF | G05 :P1 | High-speed machining mode I ON | G05 :P2 | High-speed machining mode II ON | G05.1: Q0 | High-speed high-accuracy control I OFF | G05.1: Q1 | High-speed high-accuracy control I ON | G05 :P10000 | High-speed high-accuracy control II ON | G05 P4 | Direct command mode ON | VAC | Variable-acceleration pre-interpolation acceleration/deceleration enabled | CSC | Corner smooth control enabled | SFR | Smooth fairing ON | SSS | SSS enabled | G08:P0 | High-accuracy control mode OFF | G08:P1 | High-accuracy control mode ON | G120.1 P1 Q2<br>(Display example) | Machining Condition Selection I | G120.1 P0 | Reference parameter selected | G120.1 P1 Q1 (*2) | Each machining condition parameter selected<br>Pn: (n=1 to 3) Machining purpose<br>Qm: (m=1 to 3) Condition |
| G54.1:P10                                                 | Workpiece coordinate system offset No.                                                                                                                                                                                                                                                                                                                                                                                                                                                                                                                                                                                                                                                                                                                                                                                                                                                                                                                                                                                                                                                                                                                                                                                                                                                                                                                                                                                                                                                                                                                                                                                                                                                                                                                                                                                                                                                                                                                                                                                                                                                                                                                                                                                                                                                                                                                                                                                                                                                                                                                                                                                                                                                                                                                                                                                                                                                                                                                                                                                                                                                                                                                                                                                                                                           |           |                                        |                        |                                                                                                                                                                                                                                                                                        |                              |                                                                                                                                                          |         |     |         |                                |         |                                 |           |                                        |           |                                       |             |                                        |        |                        |     |                                                                           |     |                               |     |                   |     |             |        |                                |        |                               |                                   |                                 |           |                              |                   |                                                                                                             |
| G5x :P<br>(x = 4 to 9)                                    | G54 Workpiece coordinate system selection 1<br>G55 Workpiece coordinate system selection 2<br>G56 Workpiece coordinate system selection 3<br>G57 Workpiece coordinate system selection 4<br>G58 Workpiece coordinate system selection 5<br>G59 Workpiece coordinate system selection 6                                                                                                                                                                                                                                                                                                                                                                                                                                                                                                                                                                                                                                                                                                                                                                                                                                                                                                                                                                                                                                                                                                                                                                                                                                                                                                                                                                                                                                                                                                                                                                                                                                                                                                                                                                                                                                                                                                                                                                                                                                                                                                                                                                                                                                                                                                                                                                                                                                                                                                                                                                                                                                                                                                                                                                                                                                                                                                                                                                                           |           |                                        |                        |                                                                                                                                                                                                                                                                                        |                              |                                                                                                                                                          |         |     |         |                                |         |                                 |           |                                        |           |                                       |             |                                        |        |                        |     |                                                                           |     |                               |     |                   |     |             |        |                                |        |                               |                                   |                                 |           |                              |                   |                                                                                                             |
| G54.1: Pyy<br>(yy = 1 to 96)                              | G54.1 Workpiece coordinate system selection<br>The number of extension sets is assigned to 0, 48, or 96 sets depending on the additional specifications.                                                                                                                                                                                                                                                                                                                                                                                                                                                                                                                                                                                                                                                                                                                                                                                                                                                                                                                                                                                                                                                                                                                                                                                                                                                                                                                                                                                                                                                                                                                                                                                                                                                                                                                                                                                                                                                                                                                                                                                                                                                                                                                                                                                                                                                                                                                                                                                                                                                                                                                                                                                                                                                                                                                                                                                                                                                                                                                                                                                                                                                                                                                         |           |                                        |                        |                                                                                                                                                                                                                                                                                        |                              |                                                                                                                                                          |         |     |         |                                |         |                                 |           |                                        |           |                                       |             |                                        |        |                        |     |                                                                           |     |                               |     |                   |     |             |        |                                |        |                               |                                   |                                 |           |                              |                   |                                                                                                             |
| G05 :P0                                                   | OFF                                                                                                                                                                                                                                                                                                                                                                                                                                                                                                                                                                                                                                                                                                                                                                                                                                                                                                                                                                                                                                                                                                                                                                                                                                                                                                                                                                                                                                                                                                                                                                                                                                                                                                                                                                                                                                                                                                                                                                                                                                                                                                                                                                                                                                                                                                                                                                                                                                                                                                                                                                                                                                                                                                                                                                                                                                                                                                                                                                                                                                                                                                                                                                                                                                                                              |           |                                        |                        |                                                                                                                                                                                                                                                                                        |                              |                                                                                                                                                          |         |     |         |                                |         |                                 |           |                                        |           |                                       |             |                                        |        |                        |     |                                                                           |     |                               |     |                   |     |             |        |                                |        |                               |                                   |                                 |           |                              |                   |                                                                                                             |
| G05 :P1                                                   | High-speed machining mode I ON                                                                                                                                                                                                                                                                                                                                                                                                                                                                                                                                                                                                                                                                                                                                                                                                                                                                                                                                                                                                                                                                                                                                                                                                                                                                                                                                                                                                                                                                                                                                                                                                                                                                                                                                                                                                                                                                                                                                                                                                                                                                                                                                                                                                                                                                                                                                                                                                                                                                                                                                                                                                                                                                                                                                                                                                                                                                                                                                                                                                                                                                                                                                                                                                                                                   |           |                                        |                        |                                                                                                                                                                                                                                                                                        |                              |                                                                                                                                                          |         |     |         |                                |         |                                 |           |                                        |           |                                       |             |                                        |        |                        |     |                                                                           |     |                               |     |                   |     |             |        |                                |        |                               |                                   |                                 |           |                              |                   |                                                                                                             |
| G05 :P2                                                   | High-speed machining mode II ON                                                                                                                                                                                                                                                                                                                                                                                                                                                                                                                                                                                                                                                                                                                                                                                                                                                                                                                                                                                                                                                                                                                                                                                                                                                                                                                                                                                                                                                                                                                                                                                                                                                                                                                                                                                                                                                                                                                                                                                                                                                                                                                                                                                                                                                                                                                                                                                                                                                                                                                                                                                                                                                                                                                                                                                                                                                                                                                                                                                                                                                                                                                                                                                                                                                  |           |                                        |                        |                                                                                                                                                                                                                                                                                        |                              |                                                                                                                                                          |         |     |         |                                |         |                                 |           |                                        |           |                                       |             |                                        |        |                        |     |                                                                           |     |                               |     |                   |     |             |        |                                |        |                               |                                   |                                 |           |                              |                   |                                                                                                             |
| G05.1: Q0                                                 | High-speed high-accuracy control I OFF                                                                                                                                                                                                                                                                                                                                                                                                                                                                                                                                                                                                                                                                                                                                                                                                                                                                                                                                                                                                                                                                                                                                                                                                                                                                                                                                                                                                                                                                                                                                                                                                                                                                                                                                                                                                                                                                                                                                                                                                                                                                                                                                                                                                                                                                                                                                                                                                                                                                                                                                                                                                                                                                                                                                                                                                                                                                                                                                                                                                                                                                                                                                                                                                                                           |           |                                        |                        |                                                                                                                                                                                                                                                                                        |                              |                                                                                                                                                          |         |     |         |                                |         |                                 |           |                                        |           |                                       |             |                                        |        |                        |     |                                                                           |     |                               |     |                   |     |             |        |                                |        |                               |                                   |                                 |           |                              |                   |                                                                                                             |
| G05.1: Q1                                                 | High-speed high-accuracy control I ON                                                                                                                                                                                                                                                                                                                                                                                                                                                                                                                                                                                                                                                                                                                                                                                                                                                                                                                                                                                                                                                                                                                                                                                                                                                                                                                                                                                                                                                                                                                                                                                                                                                                                                                                                                                                                                                                                                                                                                                                                                                                                                                                                                                                                                                                                                                                                                                                                                                                                                                                                                                                                                                                                                                                                                                                                                                                                                                                                                                                                                                                                                                                                                                                                                            |           |                                        |                        |                                                                                                                                                                                                                                                                                        |                              |                                                                                                                                                          |         |     |         |                                |         |                                 |           |                                        |           |                                       |             |                                        |        |                        |     |                                                                           |     |                               |     |                   |     |             |        |                                |        |                               |                                   |                                 |           |                              |                   |                                                                                                             |
| G05 :P10000                                               | High-speed high-accuracy control II ON                                                                                                                                                                                                                                                                                                                                                                                                                                                                                                                                                                                                                                                                                                                                                                                                                                                                                                                                                                                                                                                                                                                                                                                                                                                                                                                                                                                                                                                                                                                                                                                                                                                                                                                                                                                                                                                                                                                                                                                                                                                                                                                                                                                                                                                                                                                                                                                                                                                                                                                                                                                                                                                                                                                                                                                                                                                                                                                                                                                                                                                                                                                                                                                                                                           |           |                                        |                        |                                                                                                                                                                                                                                                                                        |                              |                                                                                                                                                          |         |     |         |                                |         |                                 |           |                                        |           |                                       |             |                                        |        |                        |     |                                                                           |     |                               |     |                   |     |             |        |                                |        |                               |                                   |                                 |           |                              |                   |                                                                                                             |
| G05 P4                                                    | Direct command mode ON                                                                                                                                                                                                                                                                                                                                                                                                                                                                                                                                                                                                                                                                                                                                                                                                                                                                                                                                                                                                                                                                                                                                                                                                                                                                                                                                                                                                                                                                                                                                                                                                                                                                                                                                                                                                                                                                                                                                                                                                                                                                                                                                                                                                                                                                                                                                                                                                                                                                                                                                                                                                                                                                                                                                                                                                                                                                                                                                                                                                                                                                                                                                                                                                                                                           |           |                                        |                        |                                                                                                                                                                                                                                                                                        |                              |                                                                                                                                                          |         |     |         |                                |         |                                 |           |                                        |           |                                       |             |                                        |        |                        |     |                                                                           |     |                               |     |                   |     |             |        |                                |        |                               |                                   |                                 |           |                              |                   |                                                                                                             |
| VAC                                                       | Variable-acceleration pre-interpolation acceleration/deceleration enabled                                                                                                                                                                                                                                                                                                                                                                                                                                                                                                                                                                                                                                                                                                                                                                                                                                                                                                                                                                                                                                                                                                                                                                                                                                                                                                                                                                                                                                                                                                                                                                                                                                                                                                                                                                                                                                                                                                                                                                                                                                                                                                                                                                                                                                                                                                                                                                                                                                                                                                                                                                                                                                                                                                                                                                                                                                                                                                                                                                                                                                                                                                                                                                                                        |           |                                        |                        |                                                                                                                                                                                                                                                                                        |                              |                                                                                                                                                          |         |     |         |                                |         |                                 |           |                                        |           |                                       |             |                                        |        |                        |     |                                                                           |     |                               |     |                   |     |             |        |                                |        |                               |                                   |                                 |           |                              |                   |                                                                                                             |
| CSC                                                       | Corner smooth control enabled                                                                                                                                                                                                                                                                                                                                                                                                                                                                                                                                                                                                                                                                                                                                                                                                                                                                                                                                                                                                                                                                                                                                                                                                                                                                                                                                                                                                                                                                                                                                                                                                                                                                                                                                                                                                                                                                                                                                                                                                                                                                                                                                                                                                                                                                                                                                                                                                                                                                                                                                                                                                                                                                                                                                                                                                                                                                                                                                                                                                                                                                                                                                                                                                                                                    |           |                                        |                        |                                                                                                                                                                                                                                                                                        |                              |                                                                                                                                                          |         |     |         |                                |         |                                 |           |                                        |           |                                       |             |                                        |        |                        |     |                                                                           |     |                               |     |                   |     |             |        |                                |        |                               |                                   |                                 |           |                              |                   |                                                                                                             |
| SFR                                                       | Smooth fairing ON                                                                                                                                                                                                                                                                                                                                                                                                                                                                                                                                                                                                                                                                                                                                                                                                                                                                                                                                                                                                                                                                                                                                                                                                                                                                                                                                                                                                                                                                                                                                                                                                                                                                                                                                                                                                                                                                                                                                                                                                                                                                                                                                                                                                                                                                                                                                                                                                                                                                                                                                                                                                                                                                                                                                                                                                                                                                                                                                                                                                                                                                                                                                                                                                                                                                |           |                                        |                        |                                                                                                                                                                                                                                                                                        |                              |                                                                                                                                                          |         |     |         |                                |         |                                 |           |                                        |           |                                       |             |                                        |        |                        |     |                                                                           |     |                               |     |                   |     |             |        |                                |        |                               |                                   |                                 |           |                              |                   |                                                                                                             |
| SSS                                                       | SSS enabled                                                                                                                                                                                                                                                                                                                                                                                                                                                                                                                                                                                                                                                                                                                                                                                                                                                                                                                                                                                                                                                                                                                                                                                                                                                                                                                                                                                                                                                                                                                                                                                                                                                                                                                                                                                                                                                                                                                                                                                                                                                                                                                                                                                                                                                                                                                                                                                                                                                                                                                                                                                                                                                                                                                                                                                                                                                                                                                                                                                                                                                                                                                                                                                                                                                                      |           |                                        |                        |                                                                                                                                                                                                                                                                                        |                              |                                                                                                                                                          |         |     |         |                                |         |                                 |           |                                        |           |                                       |             |                                        |        |                        |     |                                                                           |     |                               |     |                   |     |             |        |                                |        |                               |                                   |                                 |           |                              |                   |                                                                                                             |
| G08:P0                                                    | High-accuracy control mode OFF                                                                                                                                                                                                                                                                                                                                                                                                                                                                                                                                                                                                                                                                                                                                                                                                                                                                                                                                                                                                                                                                                                                                                                                                                                                                                                                                                                                                                                                                                                                                                                                                                                                                                                                                                                                                                                                                                                                                                                                                                                                                                                                                                                                                                                                                                                                                                                                                                                                                                                                                                                                                                                                                                                                                                                                                                                                                                                                                                                                                                                                                                                                                                                                                                                                   |           |                                        |                        |                                                                                                                                                                                                                                                                                        |                              |                                                                                                                                                          |         |     |         |                                |         |                                 |           |                                        |           |                                       |             |                                        |        |                        |     |                                                                           |     |                               |     |                   |     |             |        |                                |        |                               |                                   |                                 |           |                              |                   |                                                                                                             |
| G08:P1                                                    | High-accuracy control mode ON                                                                                                                                                                                                                                                                                                                                                                                                                                                                                                                                                                                                                                                                                                                                                                                                                                                                                                                                                                                                                                                                                                                                                                                                                                                                                                                                                                                                                                                                                                                                                                                                                                                                                                                                                                                                                                                                                                                                                                                                                                                                                                                                                                                                                                                                                                                                                                                                                                                                                                                                                                                                                                                                                                                                                                                                                                                                                                                                                                                                                                                                                                                                                                                                                                                    |           |                                        |                        |                                                                                                                                                                                                                                                                                        |                              |                                                                                                                                                          |         |     |         |                                |         |                                 |           |                                        |           |                                       |             |                                        |        |                        |     |                                                                           |     |                               |     |                   |     |             |        |                                |        |                               |                                   |                                 |           |                              |                   |                                                                                                             |
| G120.1 P1 Q2<br>(Display example)                         | Machining Condition Selection I                                                                                                                                                                                                                                                                                                                                                                                                                                                                                                                                                                                                                                                                                                                                                                                                                                                                                                                                                                                                                                                                                                                                                                                                                                                                                                                                                                                                                                                                                                                                                                                                                                                                                                                                                                                                                                                                                                                                                                                                                                                                                                                                                                                                                                                                                                                                                                                                                                                                                                                                                                                                                                                                                                                                                                                                                                                                                                                                                                                                                                                                                                                                                                                                                                                  |           |                                        |                        |                                                                                                                                                                                                                                                                                        |                              |                                                                                                                                                          |         |     |         |                                |         |                                 |           |                                        |           |                                       |             |                                        |        |                        |     |                                                                           |     |                               |     |                   |     |             |        |                                |        |                               |                                   |                                 |           |                              |                   |                                                                                                             |
| G120.1 P0                                                 | Reference parameter selected                                                                                                                                                                                                                                                                                                                                                                                                                                                                                                                                                                                                                                                                                                                                                                                                                                                                                                                                                                                                                                                                                                                                                                                                                                                                                                                                                                                                                                                                                                                                                                                                                                                                                                                                                                                                                                                                                                                                                                                                                                                                                                                                                                                                                                                                                                                                                                                                                                                                                                                                                                                                                                                                                                                                                                                                                                                                                                                                                                                                                                                                                                                                                                                                                                                     |           |                                        |                        |                                                                                                                                                                                                                                                                                        |                              |                                                                                                                                                          |         |     |         |                                |         |                                 |           |                                        |           |                                       |             |                                        |        |                        |     |                                                                           |     |                               |     |                   |     |             |        |                                |        |                               |                                   |                                 |           |                              |                   |                                                                                                             |
| G120.1 P1 Q1 (*2)                                         | Each machining condition parameter selected<br>Pn: (n=1 to 3) Machining purpose<br>Qm: (m=1 to 3) Condition                                                                                                                                                                                                                                                                                                                                                                                                                                                                                                                                                                                                                                                                                                                                                                                                                                                                                                                                                                                                                                                                                                                                                                                                                                                                                                                                                                                                                                                                                                                                                                                                                                                                                                                                                                                                                                                                                                                                                                                                                                                                                                                                                                                                                                                                                                                                                                                                                                                                                                                                                                                                                                                                                                                                                                                                                                                                                                                                                                                                                                                                                                                                                                      |           |                                        |                        |                                                                                                                                                                                                                                                                                        |                              |                                                                                                                                                          |         |     |         |                                |         |                                 |           |                                        |           |                                       |             |                                        |        |                        |     |                                                                           |     |                               |     |                   |     |             |        |                                |        |                               |                                   |                                 |           |                              |                   |                                                                                                             |
| (3) Tool length and wear compensation amount display area | <p>This area displays the tool length and wear compensation amount.</p> <p>TX: Displays the sum of the tool length and wear compensation amount of the first axis for the tool in use. (*3)</p> <p>TZ: Displays the sum of the tool length and wear compensation amount of the second axis for the tool in use. (*3)</p> <p>TY: Displays the sum of the tool length and wear compensation amount of the additional axis for the tool in use. (*4)</p> <p>TC: Displays the sum of the tool length and wear compensation amount of the second additional axis for the tool in use. (*5)</p>                                                                                                                                                                                                                                                                                                                                                                                                                                                                                                                                                                                                                                                                                                                                                                                                                                                                                                                                                                                                                                                                                                                                                                                                                                                                                                                                                                                                                                                                                                                                                                                                                                                                                                                                                                                                                                                                                                                                                                                                                                                                                                                                                                                                                                                                                                                                                                                                                                                                                                                                                                                                                                                                                        |           |                                        |                        |                                                                                                                                                                                                                                                                                        |                              |                                                                                                                                                          |         |     |         |                                |         |                                 |           |                                        |           |                                       |             |                                        |        |                        |     |                                                                           |     |                               |     |                   |     |             |        |                                |        |                               |                                   |                                 |           |                              |                   |                                                                                                             |

| Display items                                                                    | Details                                                                                                                                                                                                                                                                                                                                                                                                                                                                                                                                                                                                                                                                                                                                                                                                                                                                                                                                                                                        |
|----------------------------------------------------------------------------------|------------------------------------------------------------------------------------------------------------------------------------------------------------------------------------------------------------------------------------------------------------------------------------------------------------------------------------------------------------------------------------------------------------------------------------------------------------------------------------------------------------------------------------------------------------------------------------------------------------------------------------------------------------------------------------------------------------------------------------------------------------------------------------------------------------------------------------------------------------------------------------------------------------------------------------------------------------------------------------------------|
| (4) Compensation number display area                                             | This area displays the compensation number.<br>TG: Displays the tool length compensation number.<br>TW: Displays the wear compensation number.                                                                                                                                                                                                                                                                                                                                                                                                                                                                                                                                                                                                                                                                                                                                                                                                                                                 |
| (5) F modal area                                                                 | This area displays the F modal value and manual feedrate.<br>FA: Displays the program command asynchronous feedrate modal value of the currently executed command.<br>FM: Displays the manual feedrate.<br>FS: Displays the program command synchronous feedrate modal value of the currently executed command.<br>FE: Displays the thread lead command synchronous feedrate modal value of the currently executed command.                                                                                                                                                                                                                                                                                                                                                                                                                                                                                                                                                                    |
| (6) MSTB area and constant surface speed control (constant surface speed S) area | <p>&lt;MSTB area&gt;</p> <p>This area displays the program command modal value for each of the currently executed commands.</p> <p>Each item displays the following information:</p> <ul style="list-style-type: none"> <li>♦S command</li> <li>♦M command</li> <li>♦T command</li> <li>♦2nd miscellaneous function (B) command</li> </ul> <p>The number of S displays varies depending on the value of the parameter "#1039 spinno" (Number of spindles).</p> <p>The number of M displays varies depending on the value of the parameter "#12005 Mfig" (M count).</p> <p>The number of T or B displays is set to "1" regardless of the value of the parameter "#12009 Tfig" (T count) and "#12011 Bfig" (B count). However, for the B display, the value is displayed or hidden depending on the value of the parameter (#1170 M2name 2nd miscellaneous code).</p> <p>For the T display, only the tool number is displayed regardless of the value of the parameter "#11038 T disp type".</p> |

(\*1) The status of group 24 command modal is displayed only when the program format switch specification is valid and the parameter "#1254 set26/bit1" is set to "1".

(\*2) G121 command: Machining Condition Selection I Cancel  
Changes to the machining condition selection command that is selected in [Setup] - [MacCond] screen.

(\*3) Displays the axis name that is set to the first and second axes in the part system for the base axis specification parameter "#1013 axname". (If no axis name is set to "#1013 axname", the axis name item is blank.)

(\*4) When the parameter "#1281 ext17 bit1" (tool offset additional axis selection) is set to "0", the display will change as follows by the parameter "#1520 Tchg34" (additional axis tool) setting.  
#1520 Tchg34 = 0: Displays the axis name configured as the third axis in the part system by the parameter "1013 axname".  
#1520 Tchg34 = 1: Displays the axis name configured as the 4th axis in the part system.  
(If no axis name is set to "#1013 axname", the axis name item is blank.)  
When the parameter "#1281 ext17 bit1" (tool offset additional axis selection) is set to "1", the name of the axis designated by the parameter "#1027 base\_J" (basic axis J) is displayed. (If the axis name designated in "#1027 base\_J" is not set to "#1013 axname", the axis name item is blank.)  
In the two-axis configuration system, the third row is not displayed.

(\*5) The axis name which is designated by the parameter "#12104 2nd add T-ofs set" (2nd additional axis tool offset setting) is displayed. The 4th line is not displayed when the parameter "#12103 2nd add T-ofs ON" (2nd additional axis tool offset ON) is not configured.

**Menus**

| Menus | Details                                                |
|-------|--------------------------------------------------------|
| Close | This closes the pop-up window and quits this function. |

**Note**

(1) The menu is common for the M system and L system.

10.2.8 Program Tree Display



This displays the main program, subprogram, MDI interrupt and user macro call nesting structure. This also displays the execution position of the main program and the subprogram (the lowest level of the nest only) as a percentage during the automatic operation.

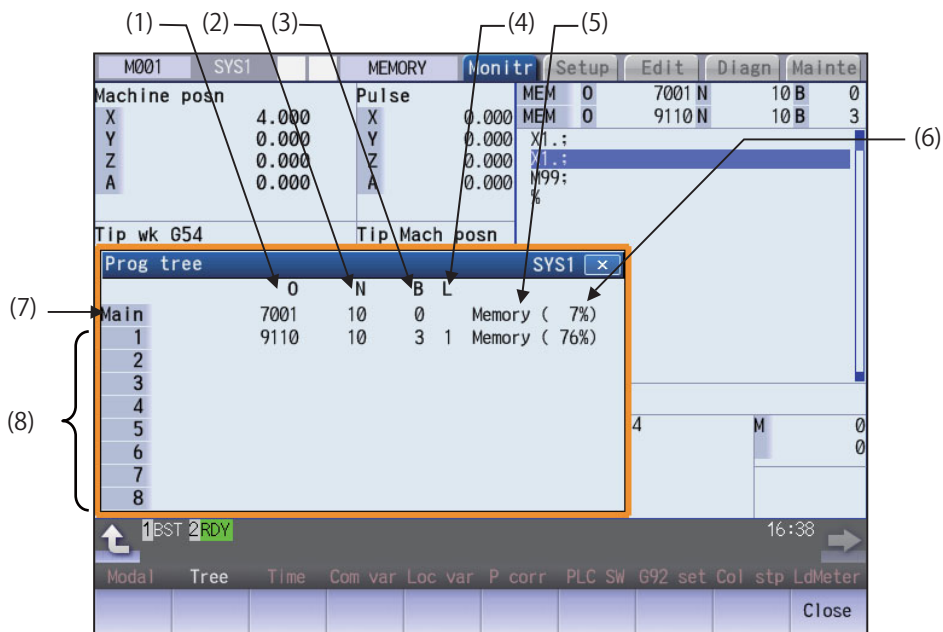

**Display items**

| Display items | Details                                                                                                                         |
|---------------|---------------------------------------------------------------------------------------------------------------------------------|
| (1) O         | Program No. (0 to 15 characters) If the program No. (program name) exceeds 15 characters, "" will appear at the 15th character. |
| (2) N         | Sequence No. (0 to 99999999)                                                                                                    |
| (3) B         | Block No. (0 to 99999)                                                                                                          |
| (4) L         | Remaining number of subprogram repetitions (0 to 99)                                                                            |



| Display items | Details                                                                                                                                                                                                                                                                                                                                                                                                        |
|---------------|----------------------------------------------------------------------------------------------------------------------------------------------------------------------------------------------------------------------------------------------------------------------------------------------------------------------------------------------------------------------------------------------------------------|
| (5) Devices   | Operation device (0 to 7 characters)<br>Displays the program storage device and MDI interruption.<br>Memory: NC Memory<br>HD: Hard disk<br>Memory card: Memory card<br>DS: Data server<br>RS-232C: NC Serial<br>MDI: MDI interruption<br>USB Memory: USB Memory                                                                                                                                                |
| (6) (%)       | Program execution rate display<br>Assuming the whole machining program size as 100%, the execution position during an automatic operation is displayed in % (percentage). When the automatic operation is not executed, 0% is displayed for the main program's percentage display.<br>The subprogram's percentage is displayed only for the lowest level of the nest and other subprograms will display blank. |
| (7) Main      | Main program                                                                                                                                                                                                                                                                                                                                                                                                   |
| (8) 1 to 10   | Called subprogram, user macro call and MDI interrupt                                                                                                                                                                                                                                                                                                                                                           |

### Menus

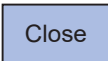
| Menus                                                                             | Details                                                |
|-----------------------------------------------------------------------------------|--------------------------------------------------------|
|  | This closes the pop-up window and quits this function. |

### Precautions

- (1) Calling the subprogram in the subprogram (M98) is available up to 10 nest levels, in case the main program is counted as 0. If it exceeds the limit, a program error occurs.
- (2) Calling the subprogram of user macro is available from level 1 to 4.
- (3) Nesting level call is available up to 10 nest levels in total of subprogram call, user macro call and MDI interruption.
- (4) Subprogram called by fixed cycle is not displayed.

10.2.9 Integrated Time Display



For details, refer to "9.3.1 Integrated Time Display".

10.2.10 Load Meter Display



The spindle load and Z axis load, etc., are displayed.

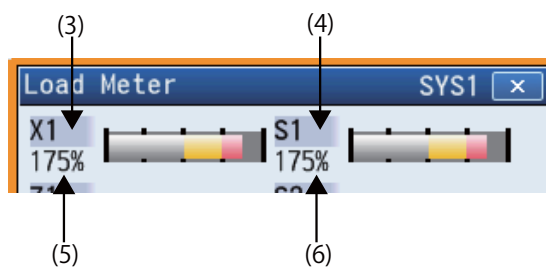
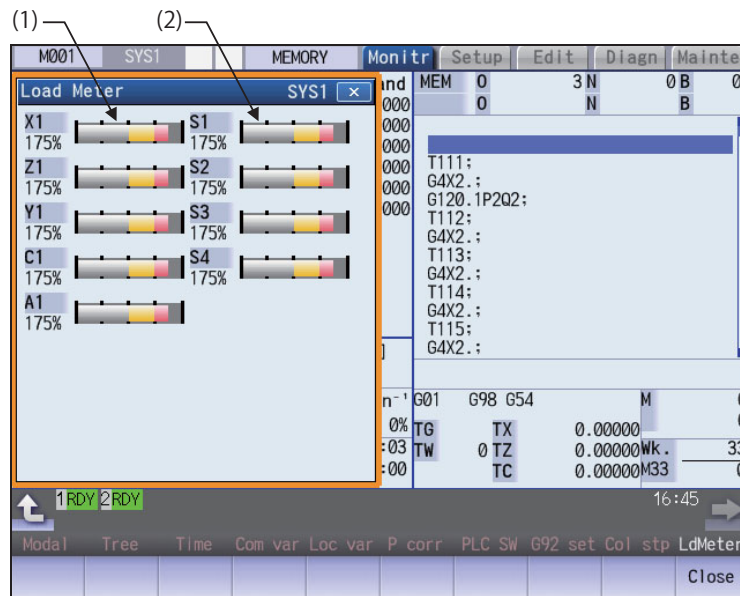

**Display items**

| Display items          | Details                                                                                                                                                                                                                                              |
|------------------------|------------------------------------------------------------------------------------------------------------------------------------------------------------------------------------------------------------------------------------------------------|
| (1) NC axis load meter | Up to eight NC axes loads (%) are displayed.<br>The display color of graph is switched in accordance with the NC axis load. The threshold values of cautions (yellow) and warning (red) are determined according to the parameters (#2643 to #2645). |
| (2) Spindle load meter | Up to eight spindles loads (%) are displayed.<br>The graph display color varies depending on the spindle load value. The threshold values of cautions (yellow) and warning (red) are determined according to the parameters (#3192 to #3194).        |
| (3) NC axis name       | This displays the axis name set with the parameter "#1022 axname2".                                                                                                                                                                                  |
| (4) Spindle name       | This displays "S" + "Spindle No.".                                                                                                                                                                                                                   |
| (5) Load current (%)   | This displays the NC axis load current.                                                                                                                                                                                                              |
| (6) Load(%)            | This displays the spindle motor load.<br>When the parameter "#3024 sout" (Spindle connection) is set to any of "2" to "5", the value which is set in the signal "Interface of load meter for analog I/F spindle" (R7012) is displayed.               |

**Menus**

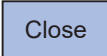
| Menus                                                                             | Details                                                |
|-----------------------------------------------------------------------------------|--------------------------------------------------------|
|  | This closes the pop-up window and quits this function. |

**Note**

- (1) Due to the specifications issued by MTB, pressing the menu [LdMeter] without setting ON load meter display causes an error.

10.2.11 Spindle, Standby Display

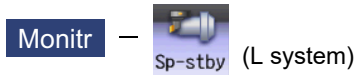

The current spindle tool No. and the standby tool No. (a maximum of 4 tools) are displayed.

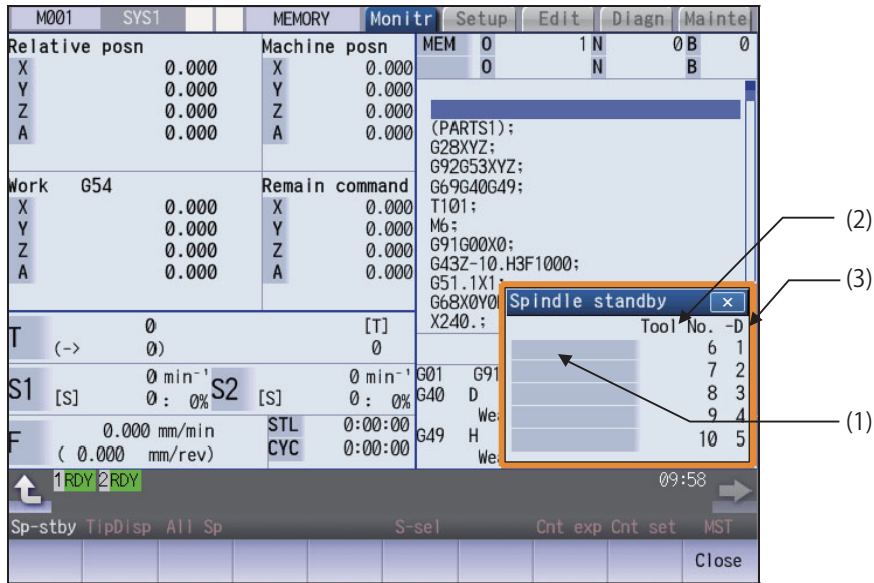

<"#11054 Sp-stby disp type" is set to "1">

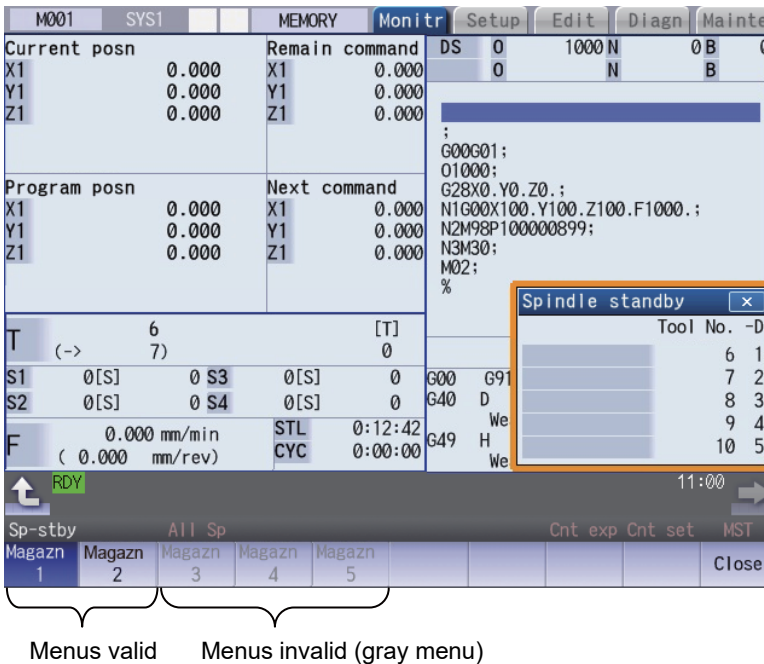

**Display items**

| Display items       | Details                                                                                                                                                             |
|---------------------|---------------------------------------------------------------------------------------------------------------------------------------------------------------------|
| (1) Spindle standby | The name of this area differs depending on the output from the PLC program.                                                                                         |
| (2) Tool No.        | This displays spindle or standby tool No.<br>Spindle/standby display for each magazine varies depending on the setting of the parameter "#11054 Sp-stby disp type". |
| (3) -D              | For D data function and purpose, refer to the instruction manual issued by the MTB.                                                                                 |

**Menus**

| Menus       | Details                                                                                                                                                                                                                        |
|-------------|--------------------------------------------------------------------------------------------------------------------------------------------------------------------------------------------------------------------------------|
| Magazn<br>1 | This switches the spindle/standby display for each magazine.<br>This menu can be switched when the parameter "#11054 Sp-stby disp type" is set to "1". When the parameter is set to "0", this menu is invalid (not displayed). |
| :           |                                                                                                                                                                                                                                |
| Magazn<br>5 | The selectable menu differs according to the machine specifications. If there are two magazines, the menus [Magazn 1] and [Magazn 2] only are selectable. The other menus will be grayed out and non-selectable.               |
| Close       | This closes the pop-up window and quits this function.                                                                                                                                                                         |

**Precautions**

- (1) The number of the standby tool to be displayed can be changed by changing the value of bit 8 to F of ATC control parameter (R10600).
- (2) If the spindle/standby display is set not to be displayed by user PLC, when the menu [Sp-stby] is pressed, the operation message "Spindle/standby tool display not possible" appears.

10.2.12 Tool Center Coordinate Display



The tool center coordinates, handle interrupt amount (tool axis movement) and tool center point speed are displayed by the following functions: the tool center point control function, the tool length compensation along tool axis function and the tool handle feed & interrupt function (handle feed along the tool axis, tool handle interrupt, tool diameter direction handle feed, nose center rotation handlefeed)

This function is an additional specification. Any of the following specifications is required.

- Tool center point control
- Tool length compensation along the tool axis
- Tool handle feed & interruption
- Workpiece installation error compensation
- Inclined surface machining command
- Simple inclined surface machining command
- 3-dimensional tool radius compensation (tool's vertical-direction compensation)
- 3-dimensional manual feed
- R-Navi

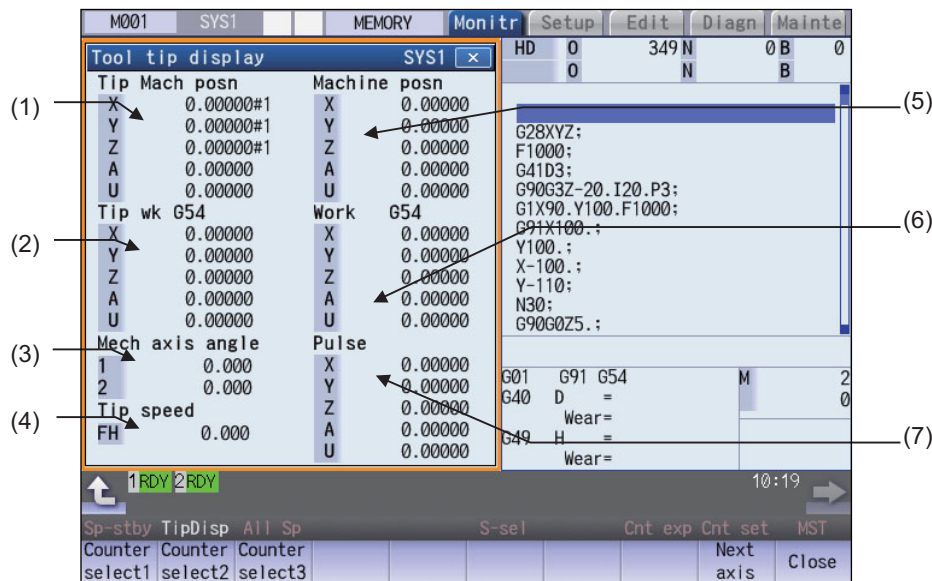

**Display items**

| Display items       | Details                                                                                                                                                      |
|---------------------|--------------------------------------------------------------------------------------------------------------------------------------------------------------|
| (1) Tip Mach posn   | This displays the position of the tool center from the machine coordinate system reference position in the machine coordinate system.                        |
| (2) Tip wk G54      | This displays the position of the tool center from the workpiece coordinate reference position in the selected workpiece coordinate system.                  |
| (3) Mech axis angle | This displays the rotation angle when using the mechanical axis.<br>1st rotary axis angle: R2628 (L)/R2629 (H)<br>2nd rotary axis angle: R2630 (L)/R2631 (H) |
| (4) Tip speed       | This displays the movement speed of tool center. By the parameter "#1125 real_f", actual feedrate and command speed can be switched.                         |

| Display items        | Details                                                                                                                                       |
|----------------------|-----------------------------------------------------------------------------------------------------------------------------------------------|
| (5) Counter display1 | The counter type can be selected from the menu.                                                                                               |
| (6) Counter display2 | The following counters are displayed by default.                                                                                              |
| (7) Counter display3 | Counter display 1: Machine position counter<br>Counter display 2: Workpiece position counter<br>Counter display 3: Tool axis movement counter |

### Note

- (1) Status abbreviations are displayed only in "Tip Mach posn" counter area. They are not displayed in other counter area.
- (2) The data for 5 axes can be displayed in each counter. In case the number of valid axis is 6 or more, and you want to display the 6th and subsequent axes, press the menu [Next axis] to switch display.

### Menus

| Menus           | Details                                                                                                                |
|-----------------|------------------------------------------------------------------------------------------------------------------------|
| Counter select1 | Select the counter type to display on "the counter display 1 to 3".<br>It is valid after the power is turned ON again. |
| Counter select2 | The counters shown below can be selected.<br>♦Machine position counter<br>♦Workpiece coordinate position counter       |
| Counter select3 | ♦Workpiece installation (*1)<br>♦Inclined surface (*2)<br>♦Tool axis movement                                          |
| Next axis       | This changes the displayed axes each counter.                                                                          |
| Close           | This closes the pop-up window and quits this function.                                                                 |

(\*1) It cannot be selected when the workpiece installation error compensation specification is not valid.

(\*2) This item cannot be selected when all of three additional specifications (inclined surface machining command, simple inclined surface machining command and R-Navi) are invalid.

10.2.13 All Spindles' Rotation Speed Display



The command rotation speed and actual rotation of all spindles are displayed.  
 This function only displays the value. It is not possible to operate here.

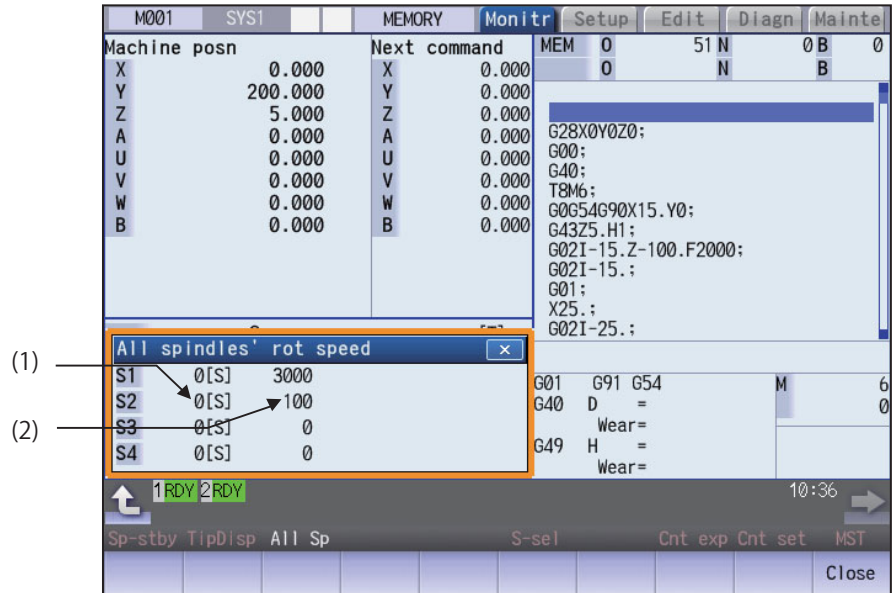

**Display items**

| Display items                        | Details                                                               |
|--------------------------------------|-----------------------------------------------------------------------|
| (1) Spindles' command rotation speed | This displays the spindles' command rotation speed (S command value). |
| (2) Spindles' actual rotation speed  | This displays the spindles' actual rotation speed (r/min).            |

**Menus**

| Menus | Details                                                |
|-------|--------------------------------------------------------|
| Close | This closes the pop-up window and quits this function. |



## 10.3 Checking the Movement under Machining (Trace Screen)

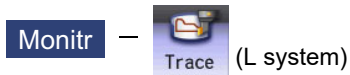
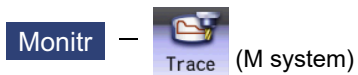

This function illustrates the actual machine's movement path or tool center point movement path, and draws the actual machine movement. This allows the machine operation to be monitored during machining. Pressing [Trace ON] changes to the machine position trace mode and pressing [Tip traceON] changes to the tool center point trace mode.

The programs that can be traced are operation searched machining programs (MDI program for MDI mode).

If no program has been operation searched, the trace window will not open.

Using the menu [All display], normal display and whole display modes can be switched.

### Note

(1) The tool center point trace function is an additional specifications. Any of the following specifications is required.

- Tool center point control
- Tool length compensation along the tool axis
- Tool handle feed & interruption
- Workpiece Installation Error Compensation
- Inclined surface machining command
- Simple inclined surface machining command
- 3-dimensional tool radius compensation (tool's vertical-direction compensation)
- 3-dimensional manual feed
- R-Navi

■ Normal display ([All display] is OFF)

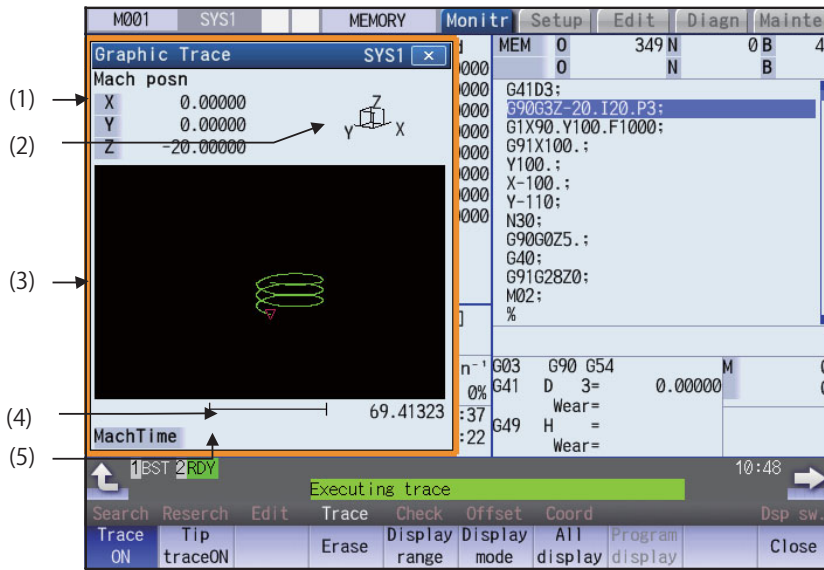

<2-plane drawing area>

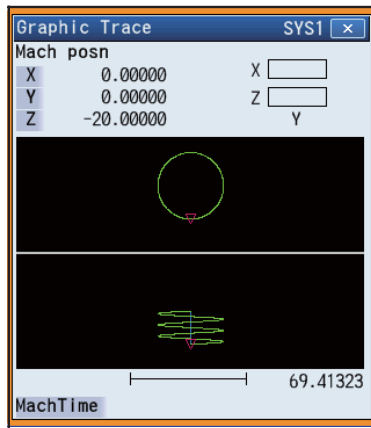

<Displaying input area>

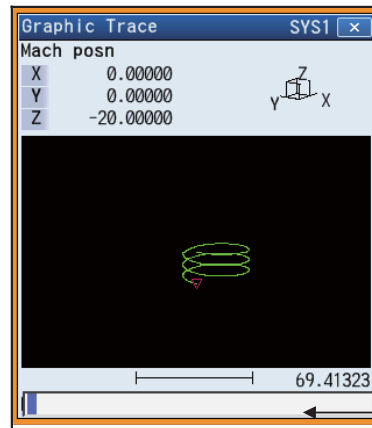

(6)

■ Full-screen display ([All display] is ON)

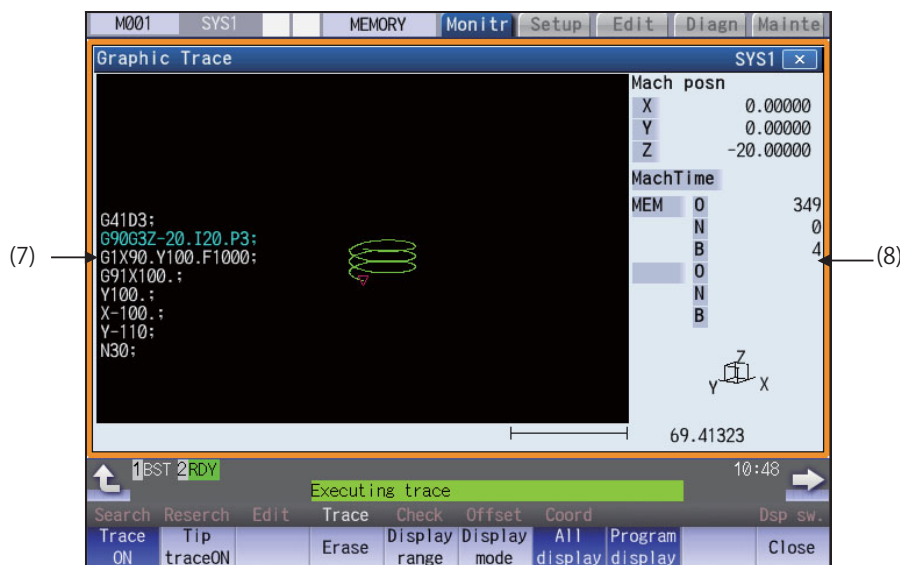

(7)

(8)

## Display items

| Display items              | Details                                                                                                                                                                                                                                                                                                                                                                                                                                                                                                                                                                                                                                                                                          |
|----------------------------|--------------------------------------------------------------------------------------------------------------------------------------------------------------------------------------------------------------------------------------------------------------------------------------------------------------------------------------------------------------------------------------------------------------------------------------------------------------------------------------------------------------------------------------------------------------------------------------------------------------------------------------------------------------------------------------------------|
| (1) Counter                | <p>The counter of the axis targeted for the trace drawing is displayed. The three axes which are displayed are set with the parameters.</p> <p>The counter selected by the menu "Counter type" is displayed.</p> <p>The counter type displayed can be set for [Trace ON] and [Tip traceON] separately. And the setting is held even after the power is turned OFF and ON.</p> <p>The default setting is as follows:<br/> [Trace ON]: depends on the setting of "#1231 set03/bit4".<br/> (0: The machine position counter (Mach posn), 1: The workpiece coordinate position counter (Work co posn))<br/> [Tip traceON]: The machine position of the tool center point counter (Tip Mach posn)</p> |
| (2) Display mode           | The plane currently being drawn is displayed.                                                                                                                                                                                                                                                                                                                                                                                                                                                                                                                                                                                                                                                    |
| (3) Trace drawing area     | <p>This area is used to draw the tool path as graphics.</p> <p>A movement path is drawn as shown below:<br/> Trace mode<br/> #1231 set03/bit1 = 0: Machine position<br/> #1231 set03/bit1 = 1: Tool position<br/> Tool center point trace mode: Tool center machine position</p> <p>The zero point to be displayed is as follows:<br/> Machine position trace mode: The zero point can be switched between the machine position zero point and workpiece coordinate position zero point with parameter "#1231 set03/bit4".<br/> Tool center point trace mode: The machine position of tool center point zero point</p>                                                                           |
| (4) Scale                  | The display range scale is displayed. The unit is set to [mm/100pixel] in millimeters and [inch/100pixel] in inches.                                                                                                                                                                                                                                                                                                                                                                                                                                                                                                                                                                             |
| (5) Machining time display | The time required for machining is calculated and displayed. Nothing is displayed during tracing.                                                                                                                                                                                                                                                                                                                                                                                                                                                                                                                                                                                                |
| (6) Input section          | <p>The input area appears when the menu [Display range] and [Display mode] are pressed.</p> <p>The scale value and display mode are set.</p> <p>The input area is hidden when the [INPUT] key is pressed.</p>                                                                                                                                                                                                                                                                                                                                                                                                                                                                                    |
| (7) Program display        | <p>At the full screen display, the contents of the machining program that is in the process of drawing are displayed.</p> <p>The block currently being executed is displayed in blue characters.</p>                                                                                                                                                                                                                                                                                                                                                                                                                                                                                             |
| (8) Program No. display    | <p>At the full screen display, the program number, sequence number, and block number which are currently being executed are displayed.</p> <p>While a subprogram is executed, its program number, sequence number, and block number are displayed.</p>                                                                                                                                                                                                                                                                                                                                                                                                                                           |

| Menus           |                                                                                                                                                                                                                                                                                                                                                                                                                                                                                                                                                                                                                       |
|-----------------|-----------------------------------------------------------------------------------------------------------------------------------------------------------------------------------------------------------------------------------------------------------------------------------------------------------------------------------------------------------------------------------------------------------------------------------------------------------------------------------------------------------------------------------------------------------------------------------------------------------------------|
| Menus           | Details                                                                                                                                                                                                                                                                                                                                                                                                                                                                                                                                                                                                               |
| Trace ON        | This activates the trace mode. If any program is currently running, the machine position path or tool position path is traced from the current position. If this menu is pressed during the trace mode, the trace mode will be turned OFF.                                                                                                                                                                                                                                                                                                                                                                            |
| Tip traceON     | This activates the tool center point trace mode. If any program is currently running, the path of tool center point machine position path or tool position path is traced from the current position. If this menu is pressed during the tool center point trace mode, the trace mode will be turned OFF. However, when the targeted specification (*1) is invalid, this menu is not displayed.                                                                                                                                                                                                                        |
| Erase           | This erases the data in graphic drawing area displayed on the screen.                                                                                                                                                                                                                                                                                                                                                                                                                                                                                                                                                 |
| Display range   | This changes the graphic drawing display range.<br>When this menu is pressed, the menu changes to the display range change menu. The input area appears. It is also possible to designate the scale value with numerical input.<br>When the display range is changed, the graphic data displayed on the screen is erased.                                                                                                                                                                                                                                                                                             |
| Display mode    | This changes the drawing plane.<br>When this menu is pressed, the menu changes to the display mode change menu.<br>There are three types of graphic drawing mode: 1-plane, 2-plane, and 3-dimension.<br>This changes the drawing plane and erases the graphic data displayed on the screen.                                                                                                                                                                                                                                                                                                                           |
| All display     | This switches the normal display mode and the full-screen display mode.                                                                                                                                                                                                                                                                                                                                                                                                                                                                                                                                               |
| Program display | This displays the currently executed program on the graphic drawing area. However, machining program contents being in the program lock state is not displayed. Only "%" is displayed.<br>This menu can be selected only when the full-screen display mode is applied.                                                                                                                                                                                                                                                                                                                                                |
| Rotate          | This sets the viewpoint angle for the 3-dimension display mode.<br>When the viewpoint angle is changed, the graphic data displayed on the screen is erased.<br>However, this menu cannot be used for other than the 3-dimension display mode.                                                                                                                                                                                                                                                                                                                                                                         |
| Std range       | The display range (scale and display position) is automatically set from the machine movable area. The machine movable area is set with the parameters "#2013 OT-" and "2014 OT+" (software limit).<br>When the display range is changed, the graphic data displayed on the screen is erased.                                                                                                                                                                                                                                                                                                                         |
| Counter type    | This displays the selected counter. For each trace mode, the counter type can be set separately. And the setting is held after the power is turned OFF and ON. However, if the menu [Trace ON] or [Tip traceON] is not highlighted, this is grayed out and non-selectable.                                                                                                                                                                                                                                                                                                                                            |
| Next axis       | This changes the axis to be displayed on the counter.<br>This switches between "the basic axes IJK" and "C axis".<br><br><Note><br><ul style="list-style-type: none"> <li>♦This menu is grayed out and non-selectable in the following cases: <ul style="list-style-type: none"> <li>- When the control axis address other than C is specified in the parameter "#19405 Rotary ax drawing".</li> <li>- When the C axis is specified by the parameter "#1026 base_I", "#1027 base_J", or "#1028 base_K".</li> <li>- When the "Graphic check/trace rotary axis drawing" specification is invalid</li> </ul> </li> </ul> |
| Close           | This closes the pop-up window and quits this function.                                                                                                                                                                                                                                                                                                                                                                                                                                                                                                                                                                |

(\*1) Targeted specifications

- ♦Tool center point control
- ♦Tool length compensation along the tool axis
- ♦Tool handle feed & interruption
- ♦Workpiece installation error compensation
- ♦Inclined surface machining command
- ♦Simple inclined surface machining command
- ♦3-dimensional tool radius compensation (tool's vertical-direction compensation)
- ♦3-dimensional manual feed
- ♦R-Navi

### 10.3.1 Displaying the Trace

**Operation method**

(1) Press the main menu [Trace ON].



The menu [Trace ON] is highlighted.  
 If [Tip TraceON] is highlighted, unhighlight it.  
 The machine position appears in the drawing area as a tool mark.  
 The counter selected by the menu [Counter type] is displayed at the counter.  
 The message "Tracing" appears.  
 After this, the machine position path is drawn with graphics in the trace mode.

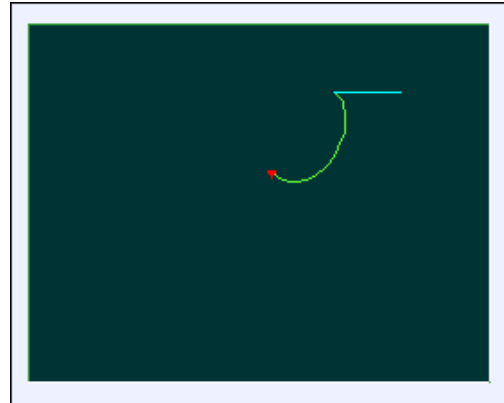

The path is drawn with a solid blue and green line.

Press the menu [Trace ON] again to cancel the trace.

Usually, paths are drawn at the machine position. Depending on the parameter setting, paths are drawn at the tool position.

#1231 set03/bit1 (Switch graphic coordinates)

| Parameter value | Description                              |
|-----------------|------------------------------------------|
| 0               | Paths are drawn at the machine position. |
| 1               | Paths are drawn at the tool position.    |

**Note**

- (1) At the machine position, the length compensation and radius compensation are applied to the path.  
 At the tool position, only the length compensation is applied to the path. If the compensation direction is changed during the machining, such as the radius compensation, the drawn path does not match the machining path.
- (2) Even if the setting of the parameter "#1231 set03/bit1" is changed, the type of the displayed counter is not switched.  
 Press the menu [Counter type] and select the counter to be displayed.
- (3) This parameter does not support the tip position trace mode.

Color of the path drawn by tracing

|                |                                 |                    |
|----------------|---------------------------------|--------------------|
| Manual feed    | Drawing at the tool position    | Solid line (white) |
|                | Drawing at the machine position | Solid line (blue)  |
| Rapid traverse | Drawing at the tool position    | Solid line (white) |
|                | Drawing at the machine position | Solid line (blue)  |
| Cutting feed   | Drawing at the tool position    | Solid line (white) |
|                | Drawing at the machine position | Solid line (green) |

## 10.3.2 Displaying the Machine Position of the Tool Center Point Trace

**Operation method**

- (1) Press the main menu [Tip TraceON].



The menu [Tip TraceON] is highlighted.  
If [Trace ON] is highlighted, unhighlight it.  
The tool center point appears in the drawing area as a tool mark.  
The counter selected by the menu [Counter type] is displayed at the counter.  
The message "Executing trace(tip posn)" appears.  
After this, the tool center point path is drawn with graphics in the tool center point trace mode.

Press the menu [Tip traceON] again to cancel the machine position of the tool center point trace.

**Note**

- (1) Even if the menu is unhighlighted, the displayed counter type does not change. However, when the trace window is closed and displayed again, the displayed counter type will be the trace mode counter.

Color of the path drawn by tracing

|                |                    |
|----------------|--------------------|
| Manual feed    | Solid line (blue)  |
| Rapid traverse | Solid line (blue)  |
| Cutting feed   | Solid line (green) |

## 10.3.3 Changing the Display Range

The graphic drawing's scale can be enlarged or reduced, and the position moved or centered.

**Operation method (Enlarging and reducing the drawing)**

- (1) Press the menu [Display range].



A white frame indicating the display range appears on the screen.  
The display range input mode is activated.

- (2) Press the menu [Zoom in] or [Zoom out].



The size of the white frame can be changed by using key operations.

To enlarge the figure:

Press the menu [Zoom in] or [-] key.

To reduce the figure:

Press the menu [Zoom out] or [+] key.

A solid-line frame appears with respect to the original scale when enlarging, and a dotted-line frame appears when reducing.

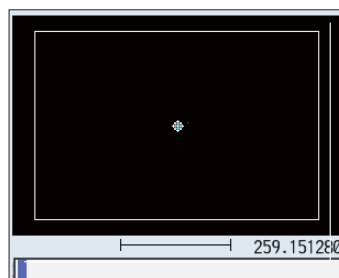

- (3) Press the [INPUT] key.



The display scale changes.  
By changing the display scale, the graphic data displayed on the screen is erased.

**Note**

- (1) The changed scale value is held even after the power is turned OFF and ON.

**Operation method (Changing the drawing display position)**

- (1) Press the menu [Display range]. ➔ A white frame indicating the display range appears on the screen.  
The display range input mode is activated.
- (2) Press the menus [↑], [↓], [←], [→] or cursor movement keys [↑], [↓], [←], [→]. ➔ The cursor (⊕) indicating the center of the display and the frame line move up, down, left and right according to the key operations.

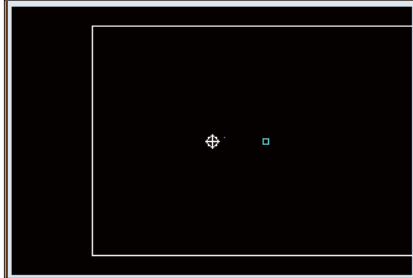

- (3) Press the [INPUT] key. ➔ The display position changes so that the cursor position (□) is the center of the area.  
When display position is changed, the graphic data displayed on the screen is erased.  
The scale value is not changed.



**Note**

- (1) When changing the display range while the 2-plane display mode such as [XY/XZ], the display range (scale and display position) for the upper and lower areas changes in the same manner.  
The operation method is the same as the 1-plane display mode.



The white-framed display range in the upper and lower areas simultaneously move to the left/right when the [←], [→] keys are pressed.  
The white-framed display range of either upper or lower areas moves up and down when the [↑], [↓] keys are pressed.  
Which frame to be moved up/down can be changed with the page key.

**Operation method (Centering)**

- (1) Press the menu [Display range].  A white frame indicating the display range appears on the screen.  
The display range input mode is activated.
- (2) Press the menu [Centering].  The display position is changed so that the current machine position appears in the center of the drawing area.  
When display position is changed, the graphic data displayed on the screen is erased.

**Note**

- (1) In the 2-plane display mode such as "XY/XZ", centering is applied for the upper and lower areas. The operation method is the same as the 1-plane display mode.

**Operation method (setting the display scale)**

- (1) Select a scale value, and press the [INPUT] key.  
(Example) 450 [INPUT]

**Note**

- (1) The setting range of scale value is as shown below.

| #1003 Input setup unit | #1014 I_inch            |                           |
|------------------------|-------------------------|---------------------------|
|                        | 0 (mm)                  | 1 (inch)                  |
| B                      | 0.100 to 9999.999       | 0.0100 to 9999.9999       |
| C                      | 0.0100 to 9999.9999     | 0.00100 to 9999.99999     |
| D                      | 0.00100 to 9999.99999   | 0.000100 to 9999.999999   |
| E                      | 0.000100 to 9999.999999 | 0.0000100 to 9999.9999999 |

- (2) The set scale value is maintained even after the power is turned OFF and ON.
- (3) If a scale value is entered while the screen is in the two-plane display mode, such as [XY/XZ], the display range (scale value) is changed for the two planes. The operation method is the same as the 1-plane display mode.



### 10.3.4 Changing the Display Mode

The graphics display mode includes the 1-plane, 2-plane and 3D mode. When the menu [Display mode] is pressed and the following display mode menu is selected, the axis configuration of each plane changes, and the menu display returns to the original state. It is also possible to change the display mode by setting the axis name to the input area.

#### Note

- (1) When display mode is changed, the graphic data displayed up to that point are erased.
- (2) These set display mode is maintained even after rebooting the machine.
- (3) The display mode can be set independently for the trace function and program check function. These settings are not linked with one another.
- (4) The menu axis names XYZ are compatible with the basic axes IJK. X = base axis I, Y = base axis J, and Z = base axis K.



#### Display mode menu

| Menus | Description                                                                                                                                                                   |
|-------|-------------------------------------------------------------------------------------------------------------------------------------------------------------------------------|
| XY    | This changes to the 1-plane display mode configured of X-Y. The X axis is displayed in the horizontal axis, and the Y axis is displayed in the vertical axis.                 |
| XZ    | This changes to the 1-plane display mode configured of X-Z. The X axis is displayed in the horizontal axis, and the Z axis is displayed in the vertical axis.                 |
| YX    | This changes to the 1-plane display mode configured of Y-X. The Y axis is displayed in the horizontal axis, and the X axis is displayed in the vertical axis.                 |
| YZ    | This changes to the 1-plane display mode configured of Y-Z. The Y axis is displayed in the horizontal axis, and the Z axis is displayed in the vertical axis.                 |
| ZX    | This changes to the 1-plane display mode configured of Z-X. The Z axis is displayed in the horizontal axis, and the X axis is displayed in the vertical axis.                 |
| ZY    | This changes to the 1-plane display mode configured of Z-Y. The Z axis is displayed in the horizontal axis, and the Y axis is displayed in the vertical axis.                 |
| XY/XZ | This changes to 2-plane display mode configured of X-Y and X-Z. The X axis is displayed as the horizontal axis, and the Y axis and Z axis are displayed as the vertical axis. |
| YX/YZ | This changes to 2-plane display mode configured of Y-X and Y-Z. The Y axis is displayed in the horizontal axis, and the X and Z axes are displayed in the vertical axis.      |
| XYZ   | This changes to the 3D display mode. A cube is displayed on the lower right of the screen.                                                                                    |

**Operation method (Changing the display mode)**

- (1) Press the menu [Display mode].  The menus for the selectable display modes appear. The input area appears.
- (2) Select the mode to display and press the menu.  
(Example) [XY/XZ]

**Operation method (Changing the display axis name)**

- (1) Press the menu [Display mode].  The menus for the selectable display modes appear. The input area appears.
- (2) Set the axis name and press the [INPUT] key.  
XYC [INPUT]  XYC appears as the axis name in the display mode. The X axis, Y axis and C axis are the three axes for drawing.

There are three types of display mode: 1- plane, 2- plane, and 3D. The display mode currently selected is shown with an image. The selected axis name displays for the image axis name.

Display example

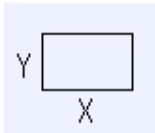
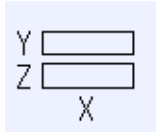
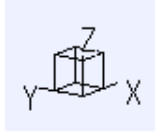
| <1-plane> (XY)                                                                     | <2-plane> (XY/XZ)                                                                  | <3-dimension> (XYZ)                                                                  |
|------------------------------------------------------------------------------------|------------------------------------------------------------------------------------|--------------------------------------------------------------------------------------|
|  |  |  |



### 10.3.5 Changing the Display Angle

This is used to set the graphic drawing display angle when in 3-dimension display mode.

#### Note

- (1) When the display angle is changed, the graphics displayed up to that point are erased.
- (2) The set display angle is maintained even after rebooting the machine.
- (3) The display angle can be set independently at the trace function and program check function. These settings are not linked with one another.
- (4) The set display angle is maintained even after rebooting the machine.

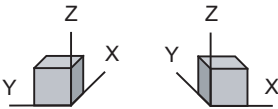
**Operation method**

- (1) Press the menu [Rotate].
- (2) Use the menus [ $\uparrow$ ], [ $\downarrow$ ], [ $\leftarrow$ ], [ $\rightarrow$ ] to adjust the display angle.  Rotate the cubic display in the lower right of the screen using the operation keys.  
The cursor movement keys ( [ $\uparrow$ ], [ $\downarrow$ ], [ $\leftarrow$ ], [ $\rightarrow$ ] ) can also be used to rotate.
- 
- (3) Press the [INPUT] key.  The display angle changes. When display angle is changed, the graphic data displayed on the screen is erased.

### 10.3.6 Displaying the Machining Program on Checking

When pressing the menu [Program display], the contents of the machining program on checking is displayed on the drawing area.

When pressing the menu [Program display] again, the displayed program is erased.

Note that this menu can be used only when the full-screen display mode is selected.

#### Note

- (1) The selected display mode is maintained even after rebooting the machine.
- (2) The program display mode is applied to the trace function and program check (2D) function commonly.
- (3) The menu [Program display] cannot be selected while the normal display mode is selected. Program display mode is valid only when the full-screen display mode is selected.
- (4) The program display mode is applied commonly to all part systems.

### 10.3.7 Switching the Full-screen Display Mode

Press the menu [All display] to display the trace window on the whole screen. (full-screen display mode).

Press this menu again to return the normal display.

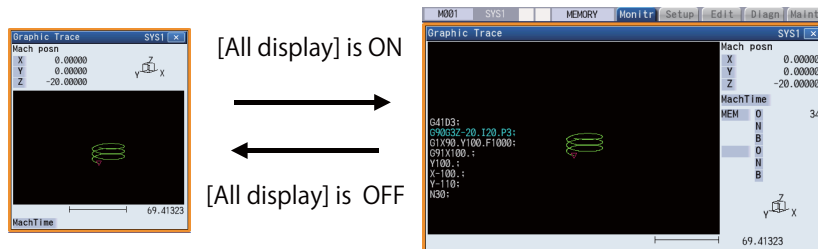

#### Note

- (1) The selected display mode is maintained even after rebooting the machine.
- (2) The full-screen display mode is applied to the trace function and program check (2D/3D solid) function commonly.
- (3) The full-screen display mode is applied commonly to all part systems.

### 10.3.8 Switching the Axis Movement Direction (+, -)

Graphic trace draws the path according to the axis movement direction designated by the parameter "#1495 grf\_ax\_direction". The movement direction can be set for each axis. For details, refer to "4.1.8 Switching the Axis Movement Direction (+, -)".

### 10.3.9 Drawing a Path Corresponding to the Rotary Axis

If a rotation axis (C axis) is designated in the parameter "#19405 Rotary ax drawing", the graphic trace draws a path corresponding to the rotary axis. The rotary axis can be set for each part system. For details, refer to "4.1.15 Drawing a Path Corresponding to the Rotary Axis (L System)".

### 10.3.10 Precautions for Tracing

- (1) When the command speed increases in the trace mode, the shape being drawn with graphics will become distorted. Especially, correct graphic drawing is not possible during machine lock.
- (2) If program check (2D) is executed during the trace mode, the trace mode will be canceled.
- (3) If trace is executed during program check mode, the program check will be canceled.

For other precautions, refer to "4.1.17 Notes for Graphic Check (2D)".

## 10.4 Restart Search



With this function, the program search can be executed while updating the coordinate values and the modal information in the same manner as an actual program operation.

Therefore, this function enables machining from a block in the middle of the program as if the actual machining was carried out from the beginning.

This function is used to restart machining when a machining program is to be resumed after it has been suspended midway due to tool damage or for some other reason.

There are two types of restart, type 1 and type 2.

| Restart method | Details                                                                                                                                                                                                                                                                                                                                                                                                                                                                                                                                                                                                                                                                                                                                                                    |                                                                                                                                                                                                                                                                                                                                                                                 |
|----------------|----------------------------------------------------------------------------------------------------------------------------------------------------------------------------------------------------------------------------------------------------------------------------------------------------------------------------------------------------------------------------------------------------------------------------------------------------------------------------------------------------------------------------------------------------------------------------------------------------------------------------------------------------------------------------------------------------------------------------------------------------------------------------|---------------------------------------------------------------------------------------------------------------------------------------------------------------------------------------------------------------------------------------------------------------------------------------------------------------------------------------------------------------------------------|
| Restart type 1 | After machining is reset due to a tool breakage, etc., machining is restarted from the designated sequence number and/or block number.<br>Only the program which had been executed just before can be restarted.<br>Even after the power is turned ON again, the program can be restarted if the program has been executed before the power supply is turned OFF.<br><Note><br><ul style="list-style-type: none"> <li>♦In case that NC has been reset or the power supply has been turned OFF while fixed cycle, custom fixed cycle, MTB macro, or macro interruption is executed, the search with no input to the setting will be performed for each source program.</li> <li>♦When the user macro is executed, the user macro execution position is searched.</li> </ul> |                                                                                                                                                                                                                                                                                                                                                                                 |
| Restart type 2 | If a machining program different from the machining program to be restarted was run before starting restart search, specify the sequence No. and block No. before restarting the machining.                                                                                                                                                                                                                                                                                                                                                                                                                                                                                                                                                                                |                                                                                                                                                                                                                                                                                                                                                                                 |
|                | Automatic top search OFF                                                                                                                                                                                                                                                                                                                                                                                                                                                                                                                                                                                                                                                                                                                                                   | A top search must be executed from the screen. Then, command a sequence No. and block No., and restart a program.                                                                                                                                                                                                                                                               |
|                | Automatic top search ON                                                                                                                                                                                                                                                                                                                                                                                                                                                                                                                                                                                                                                                                                                                                                    | A top search may not be executed from the screen. A top search is automatically executed, so it is not necessary to execute a top search from the screen. Command a sequence No. and block No., and restart a machining.<br>An arbitrary program can be restarted by designating the program No.<br>When a program No. is omitted, the program currently searched is restarted. |

The validity of the automatic top search can be changed with control parameter "#8914 Auto Top search".

Screen transition

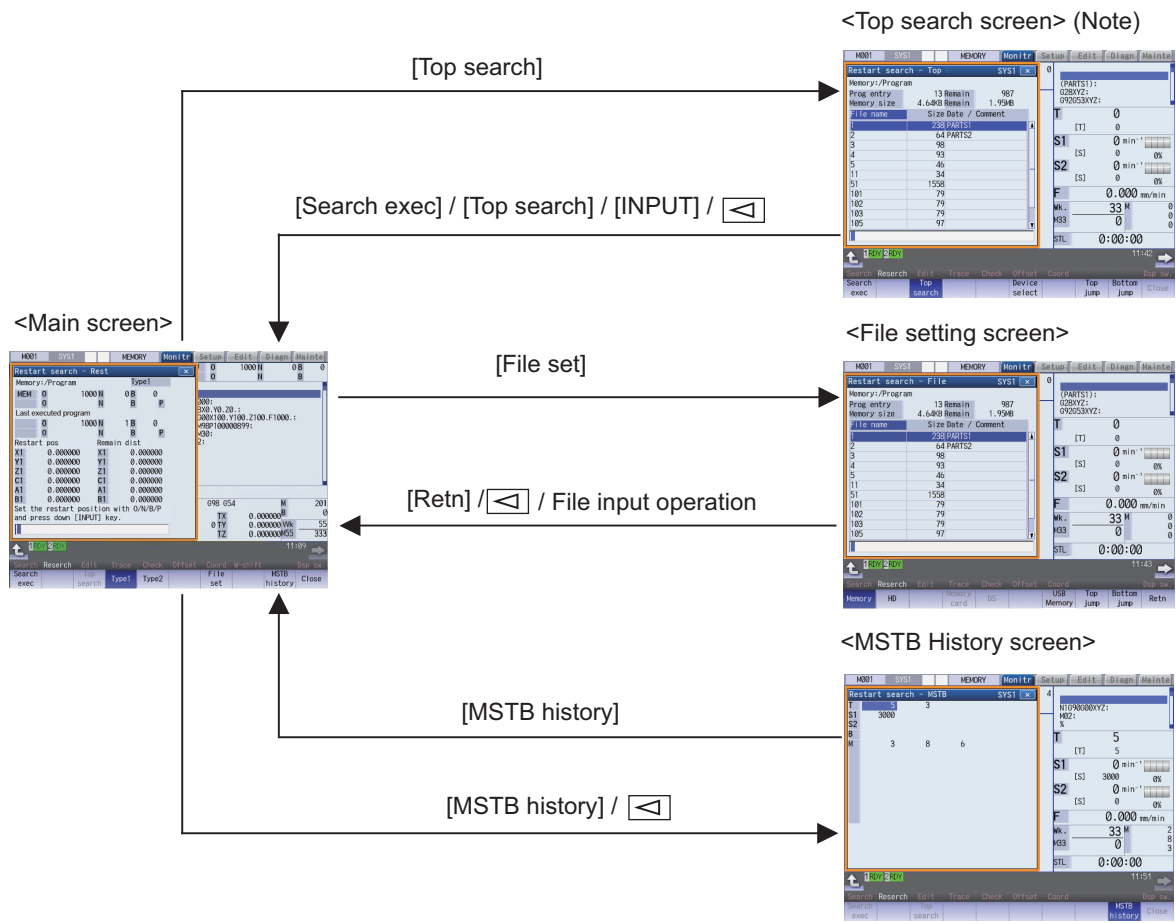

**Note**

- (1) In the following cases, the screen cannot be switched to top search screen.
  - Restart type 1
  - The parameter "#8914 Auto Top search" is "1" (automatic top search)

**Precautions**

- (1) Set the tool offset amounts and parameters before proceeding the program restart search. If they are not set beforehand, the axes will not return to the proper machining start position.
- (2) The axes will not return to the proper machining start position if a program using the user macro external signal input, machine coordinate readout or external mirror image command executes the restart search.
- (3) If an attempt was made to shift the coordinate systems by manual or MDI interrupt the last time the machining program was being executed, the axes will not return to the proper machining position.
- (4) When using the type 1, a top search for the head of the program is not available. Restart search of the type 1 searches from the previous operation start block and locates the designated block as it memorizes the operation start block previously operated.
- (5) When "#8914 Auto Top search" is set to "0" for the type 2, an error message "Top search not completed" appears if the search is attempted directly with the type 2 without executing the top search. Conduct the top search first.
- (6) The macro statement blocks cannot be searched for both type 1 and type 2. It is possible to execute the restart search if the control parameter "#8101 MACRO SINGLE" is set to ON. However, note that the tool path may change because of the radius compensation, the corner R/C, and geometric read ahead blocks.
- (7) When executing the restart for the type 1 with a tape, the axes will not return to the proper machining start position if the operation starts from midway of the tape.
- (8) WHILE/GOTO statement cannot be used for a tape operation. Thus, if a restart search is executed with the tape operation which includes WHILE/GOTO statement, a program error (P295) will occur.
- (9) In a multi-part system, perform restart search operation in each part system.
- (10) When the linear-type rotary axis returns to the restart position, control returns to the workpiece coordinate position.
- (11) A program restart search is not available at the head of the program. Restart search settings are possible, but control may not return to the correct position when the head of the program is searched.
- (12) If the parameter "#1151 rstini" is set to "0" (No reset initial) in the program without the sequence number, a restart search (type 1) may not function properly after reset 1 has been executed. Therefore, assign a sequence number to each program.
- (13) If INPUT/search is carried out without designating any value in the input area, a restart search is performed using the previously executed ONB number (type 1 only). If a reset is executed during MDI interruption processing, a restart search is performed using the previous ONB number for MDI interruption.
- (14) If INPUT/search is carried out without designating any value in the input area, the position of the ONB number that first matches the designated condition is searched at restart, regardless of the number of repetitions.
- (15) When the previously executed program is RS232C, the operation message "Search error" appears if INPUT/search is carried out without designating any value in the input area.
- (16) If a restart search is carried out while an error remains in the program, it may cause a search error. When a search error occurs, correct the program after resetting, and perform a restart search again.
- (17) When the operation mode is set to the MDI mode, a restart search is not available. If an attempt is made to carry out a restart search, the operation message "Can't search in MDI mode" is displayed.
- (18) Restart search is available for a program that has a file name consisting of up to 32 characters. Restart search is not available for a program that has a file name consisting 33 or more characters.
- (19) Restart search is not available for sub part system (I/II) for M80 Series. If restart search is carried out, the message "Search error" appears.
- (20) Restart search is not available for sub part system II for M800 Series. If restart search is carried out, the message "Search error" appears.
- (21) A search error will occur if an intended ONB is not found even M99 block is detected in the main program.
- (22) A error will occur if the M99 block in the main program is searched.
- (23) When "#1122 pglk\_c" (Program display lock C) is set to "2", the restart search cannot be executed as "Program display lock C" is applied.
- (24) If both N and B are omitted, it will be assumed as the head of the program and the number of repetitions is considered as "1" even the P number is designated.
- (25) When either N or B is omitted, the omitted one is assumed as "0".
- (26) Restart search cannot be carried out during the surface selection by R-Navi. A program error (P49) will occur.
- (27) Restart search cannot be carried out for a block that comes after any of the following command blocks. A program error (P49) will occur.  
3-dimensional circular interpolation, cylindrical interpolation, polar coordinate interpolation, milling interpolation, tool center point control, simple tool center point control, inclined surface machining, simple inclined surface machining, workpiece installation error compensation, axis name switch, mixed control, machining condition selection I, sub part system control I, sub part system control II, direct command mode or arbitrary axis exchange control

- (28) When you execute the restart search to a block in synchronous tapping cycle modal, issue the S code for a tapping spindle from MSTB history menu. If it is not issued, the tapping spindle execute the synchronous tapping with current gear step without changing the gear.
- (29) The number of program repetitions, "P", can be designated up to the total value of the same number of sub-program repetitions, "L", described on the program.
- (30) When "#8129 Subpro No. select" is set to "1" or "2", it triggers a restart search on a sub-program with the O number. Therefore, to designate the program number, it must be prefixed by an "O".
- (31) When an operation search or type 2 top search is carried out, the last program which is operating immediately before the search is retained. However, type 1 restart search cannot be carried out for the program. If type 1 restart search is carried out in this situation, the message "Search error" displayed. Perform type 2 restart search.
- (32) Restart search is carried out for the selected part system. For multi-part system, perform the restart search for each part system.

#### Precautions (For multi-part system)

- (1) If any ONBP is designated, restart search is only carried out in the displayed part system. (This operation is available when this function is invalid.)
- (2) The type 2 restart search cannot be carried out without ONBP designation; therefore, only the type 1 restart search becomes available for all part systems in batch.
- (3) The top search and type 2 restart search are carried out only in the displayed part system.
- (4) If an error occurs during a restart search for all part systems in batch, the numbers of all the part systems that are judged to be abnormal are displayed in the format "\$ + part system number" following the "Search error" message.
- (5) If the O number of the currently searched machining program is inconsistent in all part systems during the restart search for all part systems in batch, a restart search is carried out in the displayed part systems (a restart search in individual part systems).  
When the restart search is completed, the number of the searched part system is displayed in the format "\$ + part system number" following the "Search completed" message.
- (6) When "#1285 ext21/bit1" is set to OFF (search by part system), restart search is only carried out in the displayed part systems even if search conditions (the O numbers of the machining programs in the NC memory and of the searched machining program are consistent in all the part systems with type 1 and no ONBP designation) are satisfied in all part systems.
- (7) If "#1285 ext21/bit1" is ON with NC memory selected, the message "Executing automatic operation", "Program restarting", or "Program checking" is displayed while any part system is under automatic operation, program restarting, or program checking.
- (8) When "#1285 ext21/bit1" is OFF with the NC memory selected, the message "Executing automatic operation", "Program restarting", or "Program checking" is displayed while the displayed part system is under automatic operation, program restarting, or program checking.
- (9) In multi-part system, carry out restart search for the queued blocks. If a restart search is carried out in a block other than the queued blocks, the block execution timing is off between the 1st part system and 2nd part system, and the machine is in danger of collision.

10.4.1 Main Screen

The type 1 and type 2 restart search can be executed from the main screen.

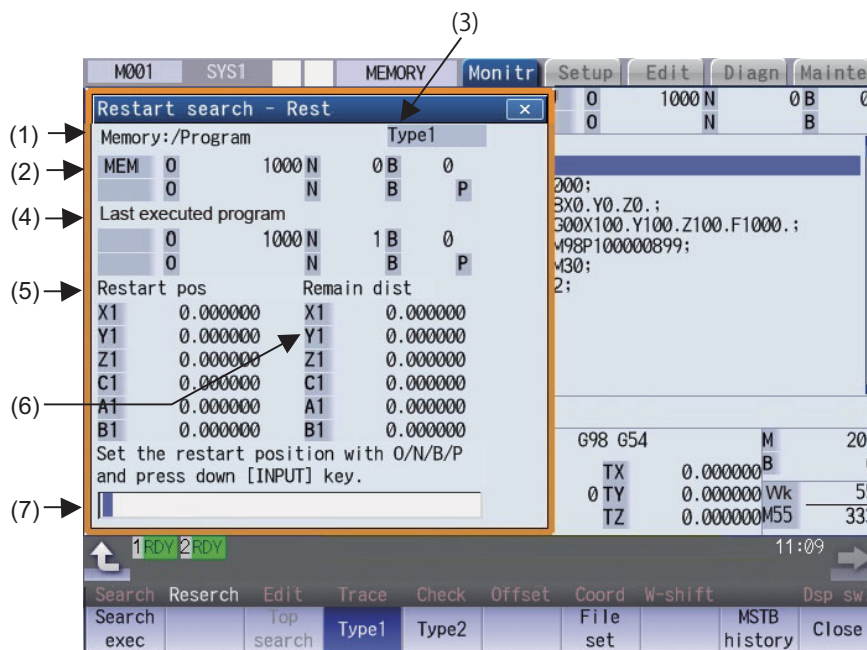

**Display items**

| Display items                                           | Details                                                                                                                                                                                                                                                                                                                                                                        |
|---------------------------------------------------------|--------------------------------------------------------------------------------------------------------------------------------------------------------------------------------------------------------------------------------------------------------------------------------------------------------------------------------------------------------------------------------|
| (1) Device name, directory display                      | This displays the device and directory where the searched machining program is located.                                                                                                                                                                                                                                                                                        |
| (2) Research position                                   | This displays the researched main program position (program No., sequence No.(*1), repeat count, block No.).                                                                                                                                                                                                                                                                   |
| (3) Restart type                                        | This displays the restart search type.                                                                                                                                                                                                                                                                                                                                         |
| (4) Last executed program position                      | This displays the last executed program position (program No., sequence No., block No., repeat count).<br>When a restart search is executed with restart type1, actual program restart position may not match the position of last executed program. Because the position is updated at the timing of machine stop operations (NC reset, single block stop or feed hold stop). |
| (5) Position when restart search is completed           | This displays the position on the local coordinate system when the restart search is completed.                                                                                                                                                                                                                                                                                |
| (6) Remaining distance when restart search is completed | This displays the remaining distance when the restart search is completed.                                                                                                                                                                                                                                                                                                     |
| (7) Input section                                       | This displays details of the key input.                                                                                                                                                                                                                                                                                                                                        |

(\*1) If the sequence number exceeds six digits, only the low-order six digits are displayed.



## Menus

| Menus           | Details                                                                                                                                                                                                                                                                           |
|-----------------|-----------------------------------------------------------------------------------------------------------------------------------------------------------------------------------------------------------------------------------------------------------------------------------|
| Search<br>exec  | This starts the restart search based on the designated device, directory, program number (O), sequence number (N), block number (B) and number of block execution times (P).                                                                                                      |
| Top<br>search   | This changes to the pop-up window for executing top search, and enables top search.<br>When the type 1 is selected or the parameter "#8914 Auto Top search" is set to "1", this menu cannot be selected.                                                                          |
| Type1           | This selects the restart search type. Restart search is executed with the highlighted restart type.<br>The type 1 or type 2 menu is always highlighted.<br>When restart search is executed, the selected restart type is displayed at the display item (3) "Restart type".        |
| Type2           |                                                                                                                                                                                                                                                                                   |
| File<br>set     | This changes to the pop-up window for setting the file, and enables the file to be selected.                                                                                                                                                                                      |
| Next<br>axis    | This switches the axis to be displayed on the counter with 8.4-type or 10.4-type. (*1)                                                                                                                                                                                            |
| MSTB<br>history | This opens the MSTB history screen as a pop-up window.<br>The M, S, T and B command used in the machining program are listed on the MSTB history screen. If the cursor is moved to the listed M, S, T or B command and the [INPUT] key is pressed, that command will be executed. |
| Close           | This closes the pop-up window and quits this function.                                                                                                                                                                                                                            |

(\*1) The menu will be grayed out and cannot be selected when the number of valid axes is six or less.

10.4.2 Top Search Screen

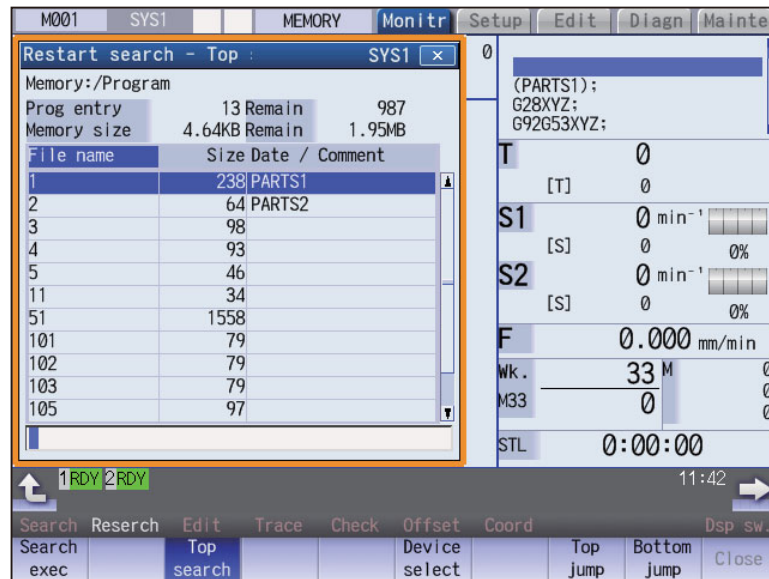

**Display items**

Same as "Operation Search".

**Menus**

| Menus           | Details                                                                                                                                                                                         |
|-----------------|-------------------------------------------------------------------------------------------------------------------------------------------------------------------------------------------------|
| Search exec     | This starts the top search based on the designated device, directory, program number (O), sequence number (N), block number (B) and number of block execution times (P).                        |
| Top search      | When the menu is highlighted, it indicates that the top search pop-up window is open. If pressed again when highlighted, the top search pop-up window closes, and the main pop-up window opens. |
| Device select   | This displays the device menu. Select which device program to search for from this menu. When a device with directory is selected, the route is selected first.                                 |
| Top jump        | Display starts from the first page of the directory/list of files. The cursor moves to the top line.                                                                                            |
| Bottom jump     | The last page of the directory/list of files is displayed. The cursor moves to the bottom line.                                                                                                 |
| Comment nondisp | This changes whether to show or hide the comment field in the list. When the comment field is hidden, the file name field will be enlarged.                                                     |
| List update     | This updates the list contents. (The latest contents of the currently selected device and directory are listed.)                                                                                |
| Sort change     | This changes the method of sorting the list.                                                                                                                                                    |

10.4.3 File Setting Screen

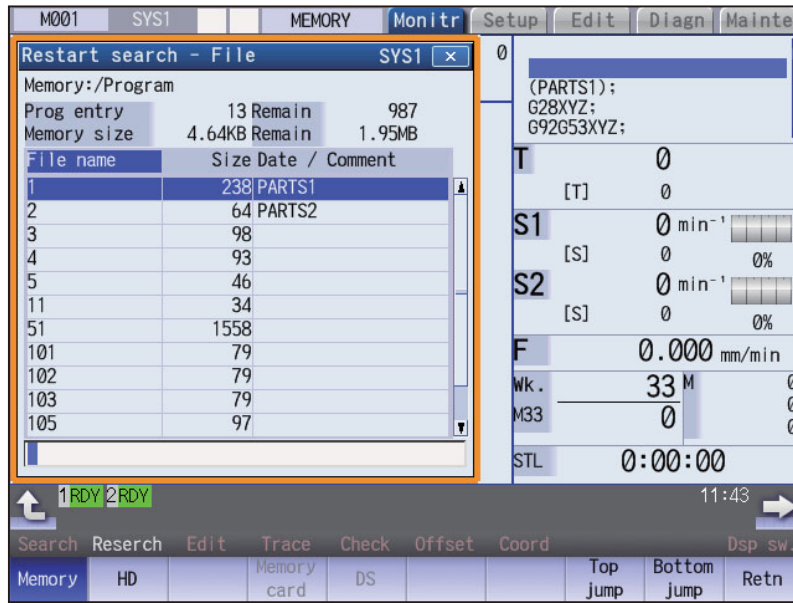

**Display items**

Same as "Operation Search".

**Menus**

| Menus           | Details                                                                                                                                        |
|-----------------|------------------------------------------------------------------------------------------------------------------------------------------------|
| Memory          | This selects the device for searching for the program.<br>When a device other than memory is selected, the root is selected first.             |
| HD              |                                                                                                                                                |
| Memory card     |                                                                                                                                                |
| DS              |                                                                                                                                                |
| USB Memory      |                                                                                                                                                |
| Top jump        | Display starts from the first page of the directory/list of files. The cursor moves to the top line.                                           |
| Bottom jump     | The last page of the directory/list of files is displayed. The cursor moves to the bottom line.                                                |
| Retn            | This returns the main menu.                                                                                                                    |
| Comment nondisp | This changes whether to show or hide the comment field in the list.<br>When the comment field is hidden, the file name field will be enlarged. |
| List update     | This updates the list contents. (The latest contents of the currently selected device and directory are listed.)                               |
| Sort change     | This changes the method of sorting the list.                                                                                                   |

10.4.4 MSTB History Screen

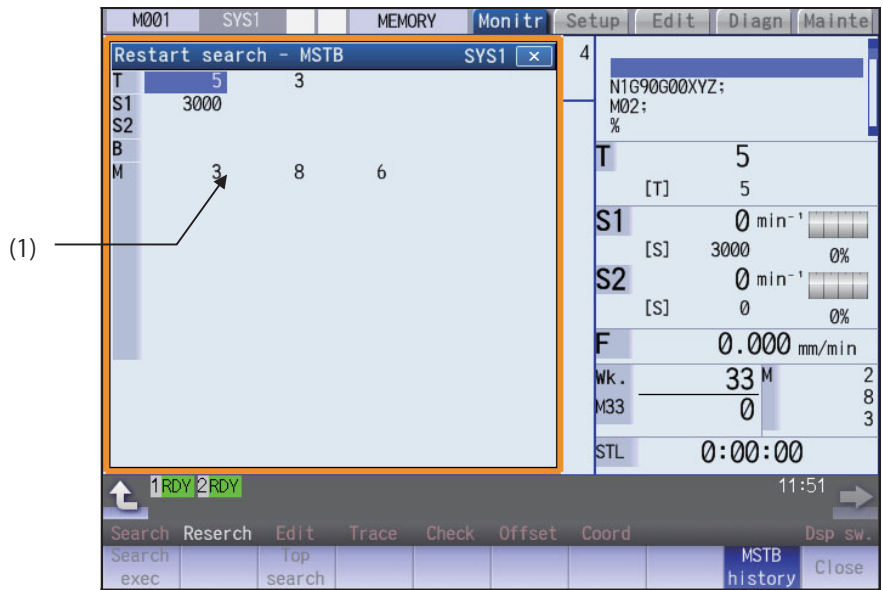

**Display items**

| Display items    | Details                                                                                                                                                                                                                                                                                                                                                                                                                                                                                                                                                                                                                                                              |
|------------------|----------------------------------------------------------------------------------------------------------------------------------------------------------------------------------------------------------------------------------------------------------------------------------------------------------------------------------------------------------------------------------------------------------------------------------------------------------------------------------------------------------------------------------------------------------------------------------------------------------------------------------------------------------------------|
| (1) MSTB history | <p>The MSTB codes used for the machining are listed after the restart search is completed.</p> <p>The displayed value can be set (manual numerical value command) as the current modal value until the reset or starting is applied. The character color is changed for the value which is once set.</p> <p>The number of displayed codes is as follows: M: up to 35, S1 to S8: 3 each, T: 3, B:3. If the number of codes used for the machining exceeds the displayable number of codes, the codes which have been used in the beginning is not displayed.</p> <p>Address T will display only the tool number regardless of the parameter (#11038 T disp type).</p> |

**Menus**

| Menus        | Details                                                                                                                                                                                                                                  |
|--------------|------------------------------------------------------------------------------------------------------------------------------------------------------------------------------------------------------------------------------------------|
| MSTB history | <p>When this is highlighted, it indicates that the MSTB history pop-up window is open. If the menu is pressed when this menu is highlighted, the system will close the MSTB history pop-up window, and the main pop-up window opens.</p> |

### 10.4.5 Operation Sequence for Program Restart

There are two types of restart, type 1 and type 2.

#### Restart type 1

When feed hold has been applied and reset because the tool has broken, etc., restart with restart type 1.

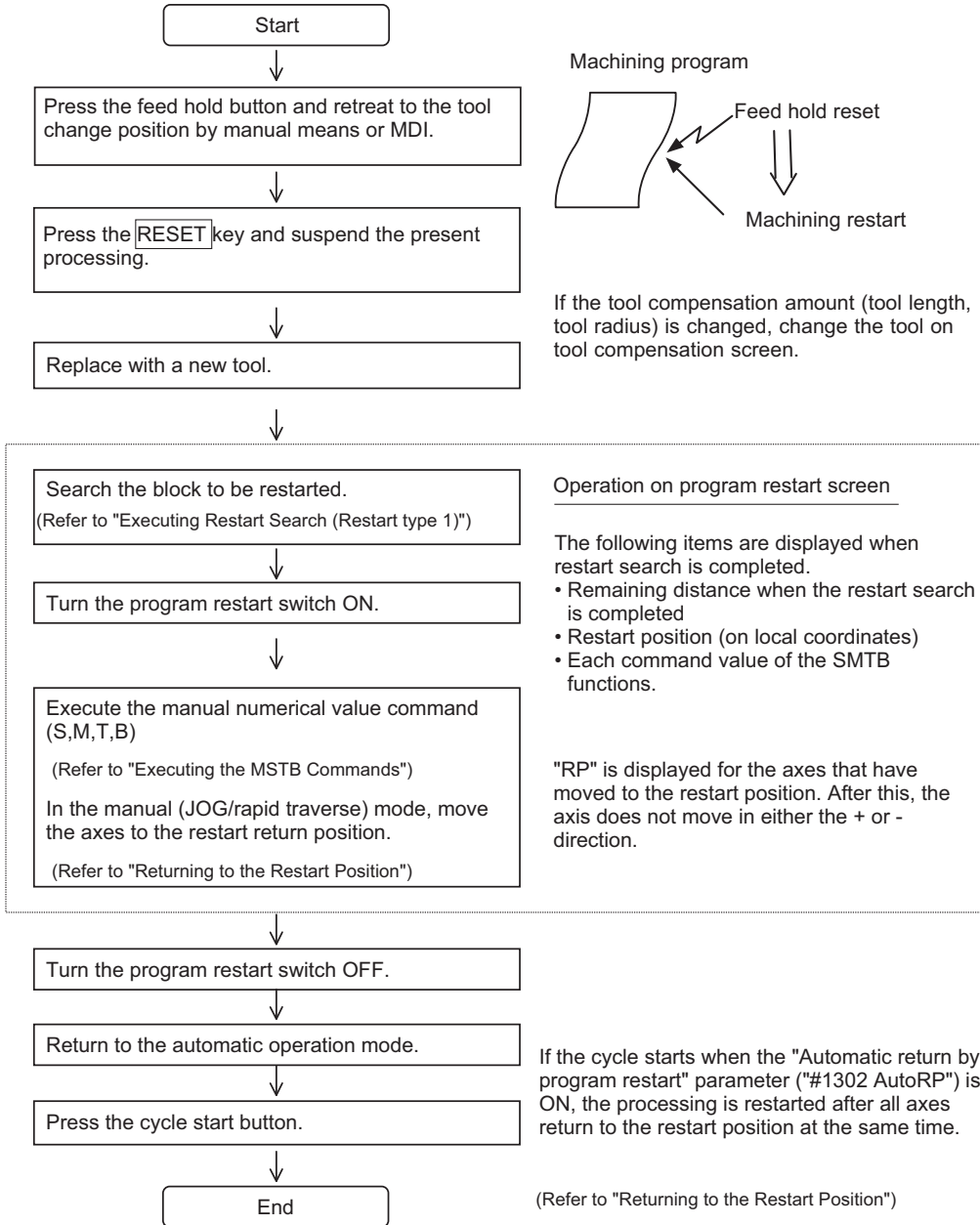

#### Note

- (1) When single block signal is OFF, the machining is restarted without stopping temporarily after the axes return to the restart position. (The cycle starts when the automatic return by program restart is valid.)
- (2) Execute "reset & rewind" for resetting.
- (3) Restart search is not available for a program that has a file name consisting 33 or more characters.

**Restart type 2**

If a machining program differing from the machining program to be restarted was run before starting restart search, restart with restart type 2.

When the coordinate system of the automatic operation last time and the coordinate system of the machining restart are changed, it is possible to restart.

**Note**

- (1) The necessary matters for starting the machining program, such as setting the coordinate system, must be completed before starting restart search.

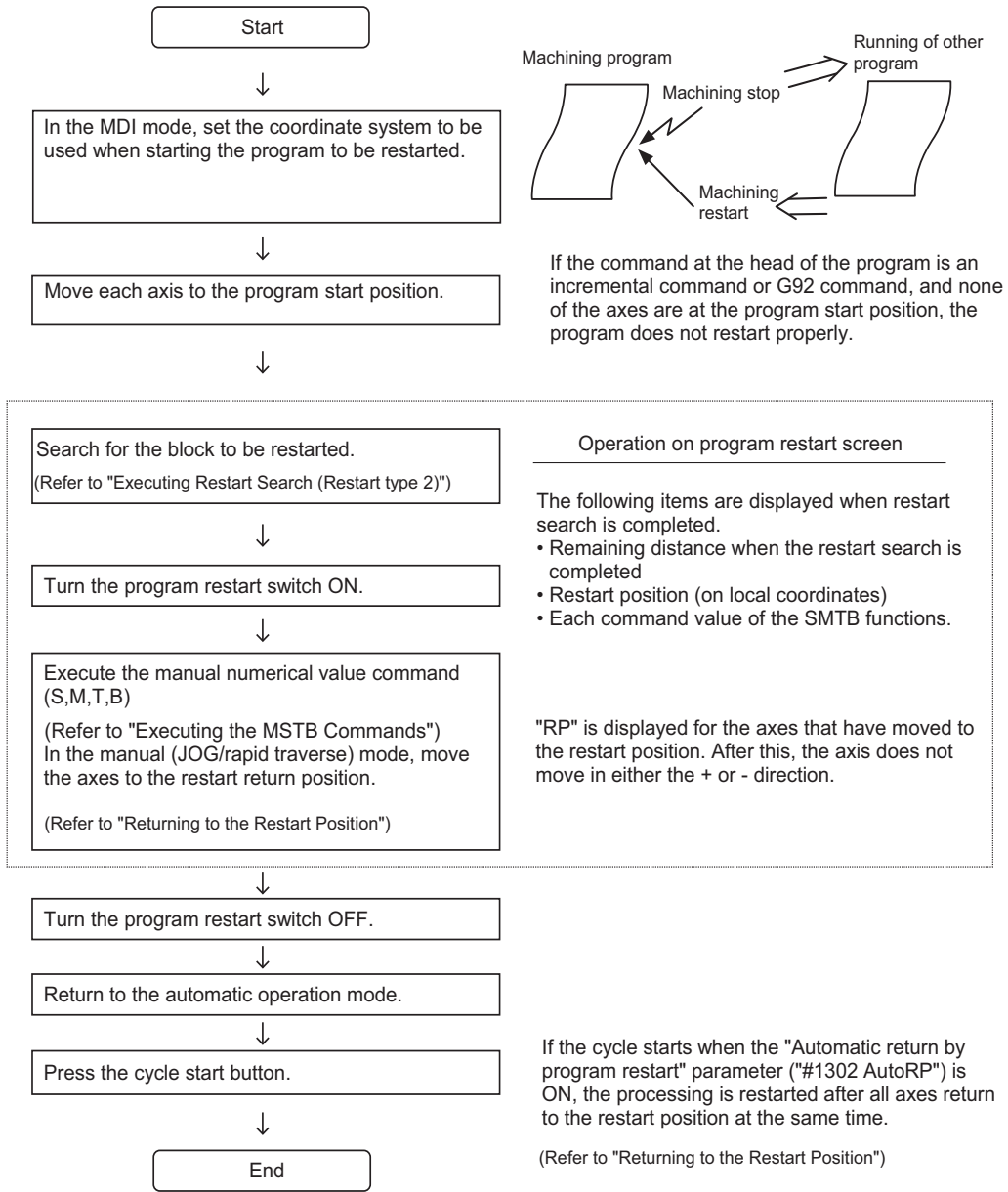

**Note**

- (1) When single block signal is OFF, the machining is restarted without stopping temporarily after the axes return to the restart position. (The cycle starts when the automatic return by program restart is valid.)
- (2) Restart search is not available for a program that has a file name consisting 33 or more characters.
- (3) When the searched program do not exist, the operation message "Search error" appears.

### 10.4.6 Executing Restart Search (Restart Type 1)



When feed hold has been applied and reset because the tool has broken, etc., restart with Restart type 1.

When the following conditions are met, the program search is executed across all part systems in batch.

- The parameter "#1285 ext21/bit0" (Multi-part system program management) is set to "1".
- The parameter "#1285 ext21/bit1" (Program search type switch) is set to "1".
- The machining program is stored in the device [Memory].
- ONBP is not used.

#### Operation method

(Example) When tool breakage during execution of O1000 N7 occurred, and restarting from the O1000 N6 block

- (1) Press the feed hold button and retreat to the tool change position by manual means or MDI. Press the reset key and suspend the present processing.
- (2) Replace with a new tool.  
When using tape operation, index the top of the tape.
- (3) Press the main menu [Reserch].  The sub-menu is displayed.  
The main screen for restart search appears as a pop-up window.
- (4) Press the [Type 1].  
Set the position to restart search in the setting area.  Delimit the ONB number in the setting area using /.  
<When O No. was attached>  
The main or sub program is targeted.  
(Example) 1000/6/0  
<When O No. was not attached>  
The program currently searched is targeted.  
(Example) /6/0  
<Note>
  - When the [INPUT] key is pressed without entering data in the input area, restart search will be carried out for the last executed block.
- (5) Press the [INPUT] key or the menu [Search exec].  Restart search is executed. (\*1)  
The message "Executing restart search" appears during the search process, and the message "Restart search is completed" appears when completed.  
Each axis' restart position and the restart remaining distance are displayed.  
When the menu [MSTB history] is pressed, the MSTB history screen will open as a pop-up window, and the M, S, T, B command used in the machining program will be listed.

(\*1) The maximum number of digits is eight for the sequence No. and nine for the block No.

#### Note

- (1) When the sorting of tool data is in progress, the operation message "Sorting of tool data is in progress" appears, and the search cannot be executed.

## 10.4.7 Executing Restart Search (Restart Type 2)









If a machining program differing from the machining program to be restarted was run with tape, memory or HD operation before starting restart search, restart the respective machining program with restart type 2.

The restart type 2 operation sequence is the same as restart type 1, but necessary matters for starting the machining program, such as setting the coordinate system, must be completed before starting restart search.

When the parameter "#8914 Auto Top search" is "0", execute the top search for the machining program.

**Operation method (When the parameter "#8914 Auto Top search" is "0")**

(Example) When restarting from subprogram O123 N6 B2 called from main program O1000

- (1) Turn the power ON, and return all axes to the reference position.
- (2) In the MDI mode, set the coordinate system to be used when starting the program to be restarted.
- (3) Move each axis to the program restart position.  
When using tape operation, index the top of the tape.
- (4) Press the main menu [Reserch].  The sub-menu is displayed.  
The main screen for restart search appears as a pop-up window.
- (5) Press the [Type 2].
- (6) Press the sub-menu [Top search].  The window for top search appears as a pop-up window.
- (7) Press the sub-menu [Device select].  
Select a device and press the menu key.
- (8) Press the [↑], [↓],  or  key to move the cursor to the directory to which the file to be set belongs.  
Press the [INPUT] key.
- (9) Press [↑], [↓],  or  key to move the cursor to  Set the cursor to 1000.  
the machining program to be edited.
- (10) Press the [INPUT] key.  The top search starts.  
The search can be executed by pressing the menu [Search exec] instead of the [INPUT] key.  
When the top search is completed, the operation message "Top search completed" appears.  
The top search pop-up window closes, and the main screen for restart search appears as a pop-up window.



- (11) Set the position to restart search in the setting area.  Delimit the ONBP number in the setting area using /.  
 <When O No. was attached>  
 The restart search is executed at designated position by NBP No. with the set O No. at the head.  
 (Example) 123.PRG/6/2/1  
 <When O No. was not attached>  
 The program currently searched is targeted.  
 (Example) /6/2/1

If subprogram repeat count is designated to the block to be searched, set the count in "P".

For example, if a block in a subprogram is searched, and the subprogram is called out several times, the block to be searched is also executed several times. Thus, which execution block to be searched must be set. (If "0" is set, it is handled in the same manner as "1".)

To search the first execution block, or to search for a block executed only once, this item does not need to be set.

- (12) Press the [INPUT] key or the menu [Search exec].  Restart search is executed. (\*1)  
 The message "Executing restart search" appears during the search process, and the message "Restart search is completed" appears when completed.  
 Each axis' restart position and the restart remaining distance are displayed.  
 When the menu [MSTB history] is pressed, the MSTB history screen will open as a pop-up window, and the M, S, T, B command used in the machining program will be listed.











(\*1) The maximum number of digits is eight for the sequence No. and nine for the block No.

### **Note**

- (1) When the sorting of tool data is in progress, the operation message "Sorting of tool data is in progress" appears, and the search cannot be executed.

**Operation method (When the parameter "#8914 Auto Top search" is "1")**

(Example) When restarting from subprogram O123 N6 B2 called from main program O1000

- (1) Turn the power ON, and return all axes to the reference position.
- (2) In the MDI mode, set the coordinate system to be used when starting the program to be restarted.
- (3) Move each axis to the program restart position.  
When using tape operation, index the top of the tape.
- (4) Press the main menu [Restart].  The sub-menu is displayed.  
The main screen for restart search appears as a pop-up window.
- (5) Press the [Type 2].
- (6) Press the sub-menu [File set].  The window for file set appears as a pop-up window.
- (7) Select a device and press the menu key.
- (8) Press the [↑], [↓],  or  key to move the cursor to the directory to which the file to be set belongs.  
Press the [INPUT] key.
- (9) Press [↑], [↓],  or  key to move the cursor to the machining program to be edited.  Set the cursor to 1000.
- (10) Press the [INPUT] key.  The screen for restart search appears as a pop-up window.
- (11) Set the position to restart search in the setting area.  Delimit the ONBP number in the setting area using /.  
<When O No. was attached>  
The restart search is executed at designated position by NBP No. with the set O No. at the head.  
(Example) 123.PRG/6/2/1  
<When O No. was not attached>  
The program currently searched is targeted.  
(Example) /6/2/1
- (12) Press the [INPUT] key or the menu [Search exec].  Restart search is executed. The message "Executing restart search" appears during the search process, and the message "Restart search is completed" appears when completed.  
Each axis' restart position and the restart remaining distance are displayed.  
When the menu [MSTB history] is pressed, the MSTB history screen will open as a pop-up window, and the M, S, T, B command used in the machining program will be listed.

### 10.4.8 Returning to the Restart Position

The axis is returned to the restart position after restart search is completed.

The method for returning to the restart position (manual/automatic) can be selected with the parameters "#1302 AutoRP".

0: Manual restart position return

1: Automatic restart position return

#### Operation method (manual restart position return)

- (1) Turn the restart switch ON.
- (2) Enter the manual (JOG/rapid traverse) mode.
- (3) Move the axis in the restart return direction.



The restart position and "RP" appear sequentially from the axes that have been returned. The Restart remaining distance is "0".

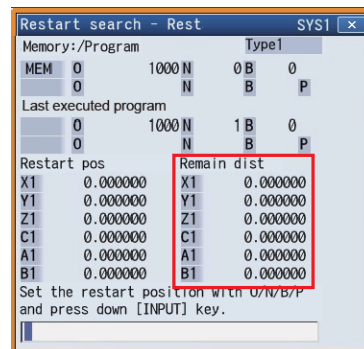

- (4) When all axes have been returned, turn the restart switch OFF.

#### Note

- (1) When the restart switch is ON, move the axis in the same direction as the restart direction. If moved in the reverse direction, the operation error "M01 R-pnt direction illegal" occurs. If the tool needs to be retracted once, such as if the tool is interfering with the workpiece, turn the restart switch OFF and retract the axis manually.
- (2) After restart position return is completed, the axis cannot be moved if the restart switch is ON. If the axis is moved, the operation error "M01 restart switch ON" occurs.
- (3) If even one axis has not completed return to the restart position at cycle start, the error "M01 Restart pos. return incomplete" occurs. Note that if the axis has been returned to the restart position once and is not at the restart position during cycle start, the alarm does not occur.
- (4) If the axis to be returned to the restart position is a machine lock axis, the operation error "M01 program restart machine lock" occurs. Release the machine lock before returning to the restart position.
- (5) If the restart switch is turned to ON after the axis is returned to the restart position with the restart switch OFF, "PR" may not be displayed. Return to the restart position after the restart switch is turned ON.
- (6) After restart search had been completed, if the movement command is issued by MDI before automatic restart position return has been started, the program error (P48) occurs. Perform the operation again after reset.
- (7) After restart search had been completed, if the T command different from the program is issued by MDI before the searched program has been started, the program error (P48) may occur. Perform the operation again after reset. T commands which result in errors are shown below. (Only L system)
  - When "#1100 Tmove" = "0"  
T command that selects a tool with different tool length/wear amount than the tool selected by the program.
  - When "#1100 Tmove" = "1"  
A program error (P48) will not occur by T command.
  - When "#1100 Tmove" = "2"  
T command that selects a tool with different wear amount than the tool selected by the program.
- (8) After restart search had been completed, if the handle interruption is performed before the searched program has been started, always the same operation as manual absolute ON is executed regardless of "Manual absolute" signal.

**Automatic restart position return**

If the parameter "#1302 AutoRP" is set to "1", each axis returns to the restart position with dry run at cycle start. Machining restarts after returning. The order that the axes return follows parameter "#2082 a\_rstax".

**Note**

- (1) Manually move the axis to a position where the tool does not interfere with the workpiece before starting the cycle.
- (2) Even if the parameter "#1302 AutoRP" is to "1", the axes can be returned manually to the restart position by turning the restart switch ON. In this case, move the axes in the order of manual restart position return -> automatic restart position return. After completing automatic restart position return, if the operation is stopped temporarily and the restart switch is turned ON, the operation error "M01 restart switch ON" occurs.
- (3) Once the axis has been manually returned to the restart position, if it is moved from the restart position, it will not return to the restart position even if automatic restart position return is executed.
- (4) The axis for which parameter "#2082 a\_rstax" is set to "0" does not return to the restart position. Note that if "0" is set for all axes, all axes simultaneously return to the restart position. Designate the axes in part system units. If the axis for which parameter "#2082 a\_rstax" is set to "0" has not completed manual restart position return when automatic restart position return is started, an error occurs. The error "M01 Restart pos. return incomplete" is displayed.
- (5) After automatic restart position return had been started, if the automatic start is executed during MDI mode before not all axes have yet to complete automatic restart position return, the error "M01 Restart pos. return incomplete" occurs.
- (6) After restart search had been completed, if the movement command is issued by MDI before automatic restart position return has been started, the program error (P48) occurs. Perform the operation again after reset.
- (7) After restart search had been completed, if the T command different from the program is issued by MDI before the searched program has been started, the program error (P48) may occur. Perform the operation again after reset. T commands which result in errors are shown below. (Only L system)
  - ◆When "#1100 Tmove" = "0"  
T command that selects a tool with different tool length/wear amount than the tool selected by the program.
  - ◆When "#1100 Tmove" = "1"  
A program error (P48) will not occur by T command.
  - ◆When "#1100 Tmove" = "2"  
T command that selects a tool with different wear amount than the tool selected by the program
- (8) After restart search had been completed, if the handle interruption is performed before the searched program has been started, always the same operation as manual absolute ON is executed regardless of "Manual absolute" signal. When manual interruption is executed to the automatic restart position return completed axis, the axis never returns the automatic restart position again.
- (9) When an axis moved to return is operated manually, the axis cannot return to correct position.



### 10.4.9 Executing the MSTB Commands

If the menu [MTB history] is pressed after restart search is completed, the MSTB commands used for machining program appear. If the cursor is moved to the listed M, S, T or B command and the [INPUT] key is pressed, that command will be executed.

Up to 35 M commands, 3 commands each for S1 to S8, 3 T commands and 3 B commands are displayed.

If many MSTB commands are used for machining, the MSTB commands used at first will not appear.

#### Operation method

- |                                                                                             |                                                                                    |                                                                                                                                   |
|---------------------------------------------------------------------------------------------|------------------------------------------------------------------------------------|-----------------------------------------------------------------------------------------------------------------------------------|
| (1) Press the sub-menu [MSTB history].                                                      |   | The pop-up window changes to the MSTB history window. The MSTB commands used for machining program are listed.                    |
| (2) Using the [↑], [↓], [→] or [←] key, move the cursor to the position of the data to set. |                                                                                    |                                                                                                                                   |
| (3) Press the [INPUT] key.                                                                  |   | The designated command is executed. A value, which has been commanded once, is grayed out. The cursor will move to the next item. |
| (4) Repeat steps (2) and (3).                                                               |                                                                                    |                                                                                                                                   |
| (5) When completed with all settings, press the menu [Close] or [MSTB history].             |  | The MSTB history pop-up window closes and the restart search main window appears as a pop-up window.                              |

### 10.5 Collation and Stop



The machining program operation can be block stopped at a registered collation and stop position. The registered collation and stop position can be canceled.

When the specified block appears, NC status will change single block stop after the execution of the block.

■When collation and stop is registered

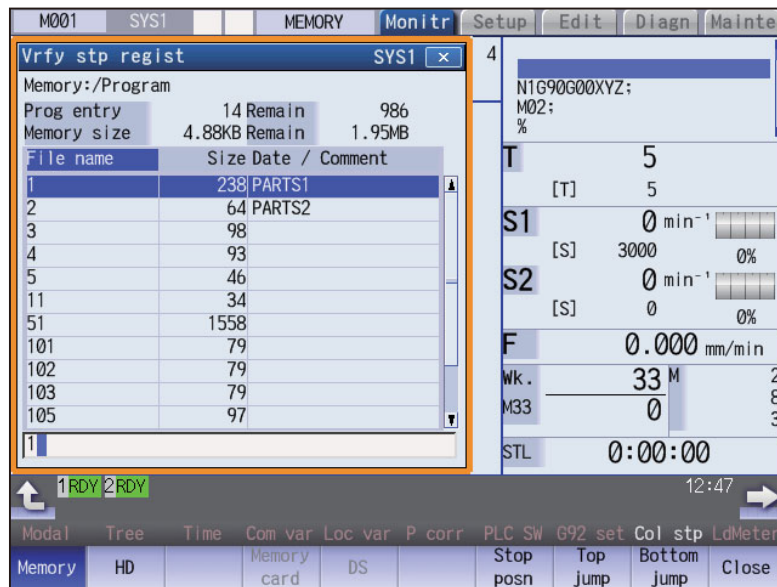

■When collation and stop position is displayed

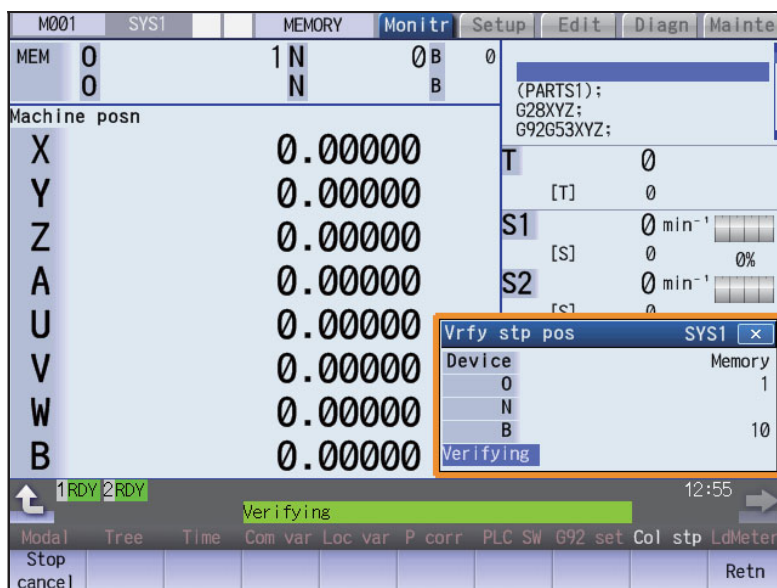

**Display items**

| Display items                      | Details                                                                                                                                                                                                                                                             |
|------------------------------------|---------------------------------------------------------------------------------------------------------------------------------------------------------------------------------------------------------------------------------------------------------------------|
| (1) Collation and stop device name | This is the name of the device to be stopped for collation.                                                                                                                                                                                                         |
| (2) Collation and stop position    | This is the position of the program where collation and stop is to be executed. This display is cleared when program stop is completed, or NC is reset or canceled. If the program No. (program name) exceeds 24 characters, "*" will appear as the 24th character. |
| (3) Display during collation       | This is displayed during collation.                                                                                                                                                                                                                                 |



**Menus (When collation and stop is registered)**

| Menus           | Details                                                                                                                                     |
|-----------------|---------------------------------------------------------------------------------------------------------------------------------------------|
| Memory          | This selects the device to be stopped for collation.<br>When a device with directory is selected, the route is selected first.              |
| HD              | <Note><br>•Devices that can be selected are different by NC models.                                                                         |
| Serial          |                                                                                                                                             |
| Memory card     |                                                                                                                                             |
| DS              |                                                                                                                                             |
| USB Memory      |                                                                                                                                             |
| Stop posn       | This opens the collation and stop position display window as a pop-up window.                                                               |
| Top jump        | Display starts from the first page of the directory/list of files. The cursor moves to the top line.                                        |
| Bottom jump     | The last page of the directory/list of files is displayed. The cursor moves to the bottom line.                                             |
| Comment nondisp | This changes whether to show or hide the comment field in the list. When the comment field is hidden, the file name field will be enlarged. |
| List update     | This updates the list contents. (The latest contents of the currently selected device and directory are listed.)                            |
| Sort change     | This changes the method of sorting the list.                                                                                                |
| Close           | This closes the pop-up window and quits this function.                                                                                      |

**Menus (When collation and stop position is displayed)**

| Menus       | Details                                                                                  |
|-------------|------------------------------------------------------------------------------------------|
| Stop cancel | This cancels the collation and stop setting. Note that automatic operation is not reset. |
| Retn        | This returns the list when collation and stop is registered.                             |

### Operation method (Registering the collation and stop)

- (1) Press the  key to select the part system to be stopped for collation. → The currently selected part system is displayed at the upper left of the screen.
- (2) Press the main menu [Col stp]. → The mode changes to the buffer correction mode.
- (3) Select the device.  
(Example) [Memory] → The selected device name and root directory (memory:/) are displayed in the device name and directory display fields.  
The menu [Memory] is highlighted.
- (4) Press the [↑], [↓], , or  key to move the cursor to the directory containing the file to be set.  
  
If the list contents differ from the actual device or directory, press the menu [List update].
- (5) Press the [INPUT] key. → Moves into the directory.
- (6) Input the program No., sequence No. and block No. using / as a delimiter. → The collation and stop position is displayed, and the program No. ("MDI" for MDI mode), sequence No., block No. and "Verifying" appear.  
(Example) 1001/1/2 [INPUT]  
When carrying out collation and stop of MDI program, set "0" as the program No.  
If pointing the cursor to a file name, the file name is echoed back to the input area.
- (7) Start the automatic operation. → When the collation and stop is completed, a message indicating the end appears.  
The stop position displayed on the screen is cleared, and the "Verifying" display is erased.

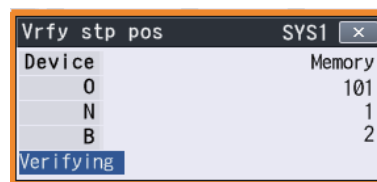

Press the menu [Stop cancel] to cancel the collation and stop.

### Note

- (1) The maximum number of digits is eight for the sequence No. and nine for the block No.
- (2) Collation and stop can be canceled during automatic operation.



**Precautions**

- (1) When registering the stop position (O, N, B values), confirm that the block exists in the searched program. Collation and stop will not be executed if the corresponding block is not found at the registered stop position.
- (2) Always set one of the O, N or B numbers. If nothing is set, a setting error will occur.
- (3) If the O No. is not set, the O No. used during operation search will be used.
- (4) If the N and B numbers are not set, the block will be searched using the O No.
- (5) If there are several sequences and blocks with the same number in one program, collation and stop will be executed after executing the first block that matches in the execution order.
- (6) The settings are canceled when collation and stop is executed.
- (7) The settings are canceled when reset is executed.
- (8) If only the program number is set, collation and stop will take place at the head of the program only when there is a program number at the first line.
- (9) Collation and stop cannot be performed or canceled for blocks being executed or blocks already read into the preread buffer.
- (10) Collation and stop is not performed in the tapping mode.
- (11) Collation and stop is possible in a subprogram, but is not possible in a MTB macro program.
- (12) If collation and stop is set for a fixed cycle block, it will be executed after the positioning block is completed.
- (13) Collation and stop is possible even when editing is locked.
- (14) Collation and stop is executed after executing the block set for the collation and stop position. If the position is set in a program call (M98) block, collation and stop will be executed before the subprogram is called.
- (15) If the set block is set to be skipped, collation and stop will not be executed.
- (16) The collation and stop position can be registered for each part system.
- (17) The stop position cannot be registered during verification.
- (18) Registration of collation and stop position is not possible for a program with 33 or more file name characters.
- (19) In the case where the device is HD, memory card, DS, or USB memory at the time of collation and stop position registration, inputting "0//" will be resulted in a setting error.
- (20) When the collation and stop position has been set in the following conditions, the collation and stop is performed for the operation searched program.  
(If the operation search target device is the same as the collation and stop target, the collation and stop is performed with the contents correctly set.)  
(Example) When the same name programs exist in the memory and HD
  - (a) Operation searched program -> Memory: 100.PRG  
Collation and stop position set program -> HD: 100.PRG
  - (b) Operation searched program -> HD: 100.PRG  
Collation and stop position set program -> Memory: 100.PRG(The collation and stop is performed for the memory in the condition (a) and performed for the HD in the condition (b).)
- (21) Collation and stop position for sub part system I/II cannot be registered for M80 Series. If it is registered, the message "Search error" appears.
- (22) Collation and stop position for sub part system II cannot be registered for M800 Series. If it is registered, the message "Search error" appears.

## 10.6 Correcting the Machining Program



### 10.6.1 Program Editing

If you press the [Edit] main menu or set the edit/search signal ON, the program editing window appears to enable you to edit a program. However, if the target program is not found (displays "00") or programs are serially searched, the editing window does not appear. The program is opened on the unselected side for the 2-part system simultaneous display.

When the program is edited, the key input data is directly written into the program display area. All data is overwritten from the cursor position. "Editing" appears on the right side of the file name display once input is started.

When the [INPUT] key is pressed, the program is saved in the NC memory and the "Editing" message disappears.

A program to be edited can be switched to the other part system's program with  $\boxed{\$ \leftrightarrow \$}$  key when a parameter "#8952 Edit-win \$ switch" is set to "1".

For information on editing operations, refer to "3.2 Creating and Editing a Machining Program".

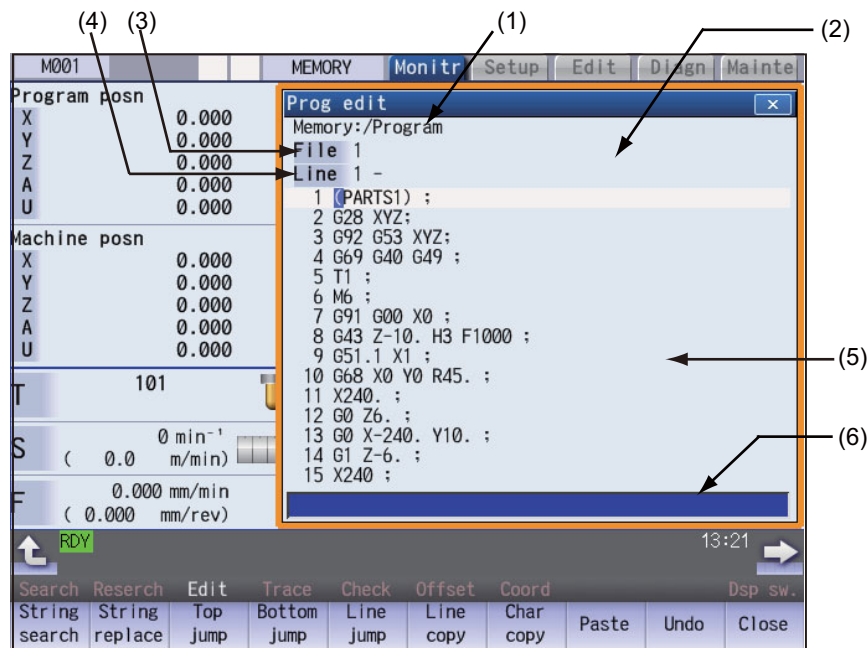

## Display items

| Display items                                                                            | Details                                                                                                                                                                                                                                                                                                                                                                                                                                                                                                                                                                                                                                                                                                                           |
|------------------------------------------------------------------------------------------|-----------------------------------------------------------------------------------------------------------------------------------------------------------------------------------------------------------------------------------------------------------------------------------------------------------------------------------------------------------------------------------------------------------------------------------------------------------------------------------------------------------------------------------------------------------------------------------------------------------------------------------------------------------------------------------------------------------------------------------|
| (1) Path display                                                                         | The path of the currently opened program file is displayed.<br>(If the path is too long, the portion exceeding single-byte 49 characters is not displayed.)<br>(Example) Memory: /Program, HD: /PRG/SUB                                                                                                                                                                                                                                                                                                                                                                                                                                                                                                                           |
| (2) Edit type display                                                                    | For mass-editing, "EX" appears. For regular editing, nothing appears.                                                                                                                                                                                                                                                                                                                                                                                                                                                                                                                                                                                                                                                             |
| Current edit display "Editing"                                                           | Displayed when the program is edited after it was displayed.                                                                                                                                                                                                                                                                                                                                                                                                                                                                                                                                                                                                                                                                      |
| Insert mode display                                                                      | The overwrite mode and insert mode are switched by pressing the [INSERT] key.<br>During insert mode: "INS" appears.<br>During overwrite mode: Nothing appears.                                                                                                                                                                                                                                                                                                                                                                                                                                                                                                                                                                    |
| (3) File name display                                                                    | This displays the file name of the program currently being edited.<br>"MDI" appears when the MDI program is edited.                                                                                                                                                                                                                                                                                                                                                                                                                                                                                                                                                                                                               |
| (4) Regular editing: top line of the displayed program<br>Mass-editing: display position | The top line of the program to be displayed is displayed.<br><br>During mass-editing, the position of the currently displayed page is displayed in percentage (rate) when the entire size of the program is assumed to be 100%.                                                                                                                                                                                                                                                                                                                                                                                                                                                                                                   |
| (5) Line number                                                                          | Each line of the program is numbered, and only the last three digits are displayed. If a line is wrapped because a line is too long, no number is assigned to the top of the next line.<br>For mass-editing, line number does not appear.                                                                                                                                                                                                                                                                                                                                                                                                                                                                                         |
| Program display                                                                          | This displays the contents of the program (machining program, MDI program) currently being edited.<br>The line that the cursor is on is highlighted. (During mass-editing, the line is not highlighted.)<br><br>If the value of the parameter "#8952 Edit-win \$ switch" is set to "1" and a part system is switched while the window is displayed, the display is changed to the program of the part system.<br>Machining program editing:<br>Switch the mode selection switch to other than "MDI mode" and press the [Edit] main menu.<br>However, to edit data, designate the machining program to execute a search.<br>MDI program editing:<br>Switch the mode selection switch to "MDI mode" and press the main menu [Edit]. |
| (6) Input section                                                                        | This displays details of the key input.                                                                                                                                                                                                                                                                                                                                                                                                                                                                                                                                                                                                                                                                                           |

A selection part system operation search can be carried out using the block with the cursor as the top.

There are 2 ways to search cursor position, "INPUT search" and "Edit/search signal search".

**INPUT search**

By pressing [INPUT] key when it is in the normal status (not being in status such as editing or character searching, etc.), operation search of the selected part system is carried out starting from the block that has the cursor.

This is enabled when "1" is set to the parameter "#11031 Cursor pos search".

- (1) Carry out the operation search to find the program to carry out the cursor position search.
- (2) Press the menu [Edit].
 

 The program edit window appears.  
 The program is displayed starting from the block currently searched.  
 (During automatic operation or checking, the program is displayed from its top.)
- (3) Move the cursor to the block to be carried out the cursor operation search.
- (4) Press the [INPUT] key.
 

 Operation search is carried out starting from the block that the cursor is positioned.  
 During the search "Searing" will display blinking.  
 When the search is completed, "Search completed" is displayed.

**Note**

- (1) When operating character string search, string replace, cursor on input unit, or editing it will not start cursor position search by pressing [INPUT] key.
- (2) A selection part system operation search can be carried out using the block with the cursor as the top.
- (3) Operating search program will be the program that was searched when program edit window was open.
- (4) Cursor position search is disabled during automatic operation, checking or restart search. However, it is enabled when the parameter "#11039 Cusr pos srch type" is 1 even if the operation is under single block stop. For details, refer to "Search during single block stop" in "10.6.1 Program Editing".
- (5) When MDI program is displayed, the block with the cursor will be set for MDI by pressing [INPUT] key.
- (6) If the [INPUT] key is pressed when the data protection is valid, the cursor position search will be executed without displaying the message "Data protect", and the message "Search completed" will appear upon completion.
- (7) If the INPUT key is pressed during automatic operation, check, or restart search while the program currently being displayed is not in a selected part system, message "Executing automatic operation", "Program checking" or "Program restarting" is not displayed. The cursor position search is carried out, and message "Search completed" is displayed.
- (8) If the N number of the block to be searched exceeds the maximum value or is set to "0", it causes a search error in all blocks that belong to the N number.
- (9) If characters other than digits follow "N" of the block to be searched, "N\*\*" of the program is handled as a normal block, not a sequence number. Therefore, if the target block is searched, it is handled as a block that belongs to the previously searched N number.

**Edit/search signal search**

This is enabled when "2" or "3" is set to the parameter "#11031 Cursor pos search".

- (1) Carry out the operation search to find the program to carry out the cursor position search.

- (2) Turn ON the edit/search signal.



The "Edit/Search" window is displayed.  
The program is displayed starting from the block currently searched.

(During automatic operation or foreground checking, the program is displayed from its top.)

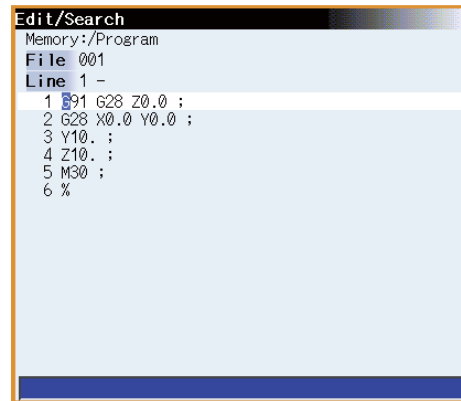

- (3) Move the cursor to the block to be carried out the cursor operation search.

- (4) Turn OFF the edit/search signal.



The "Edit/Search" window is closed, and the operation search is carried out starting from the block that has the cursor.

When the search is completed, "Search completed" is displayed.

(Also in the case where the screen is changed with a function key, etc. and the "Edit/Search" window is closed, the operation search is carried out.)

**Note**

- (1) If the "edit/search signal" is set to ON on a screen other than the monitor screen, the "Edit/Search" window is not displayed. To display the "Edit/Search" window, switch to the monitor screen. Switching to the monitor screen automatically displays the "Edit/Search" window.
- (2) If a window (operation search window, menu list, guidance, custom window, etc.) other than the program edit window is displayed while the monitor screen is being displayed, the "Edit/Search" window is not displayed even if the edit/search signal is set to ON. To display the "Edit/Search" window, close the currently displayed window. When the currently displayed window is closed, the "Edit/Search" window is displayed automatically.
- (3) If the edit/search signal is set ON during display of the program edit window on the monitor screen, the display changes to the "Edit/Search" window while the editing contents, cursor position, and menu etc. remain unchanged.
- (4) If the "Edit/Search" window is attempted to be closed during editing, a message to confirm whether to save the data will appear.  
When it appears, if save is carried out by pressing the [Y] or [INPUT] key, the operation search will be carried out starting from the block that has the cursor.  
If save is not carried out, the edited data will be aborted, and the operation search will not be carried out.
- (5) If the "Edit/Search" window is closed while the cursor is positioned in the input area during string searching or string replacement, the operation is canceled, and the cursor returns to the editing area. After this, an operation search is carried out with the block located by the cursor at the top. However, during editing, the cursor returns to the editing area, and the same operation as that described in (3) is performed.

- (6) If the "Edit/Search" window is displayed while the automatic operation, check, or restart search is in process in the selected part system, message "Executing automatic operation", "Program checking" or "Program restarting" is displayed. However, when "#11039 Cusr pos srch type" is set to "1", cursor position search is possible even in the single block stop state. For details, refer to "Search during single block stop" in "10.6.1 Program Editing".
- (7) If the "Edit/Search" window is closed during automatic operation, program check, or restart search in the selected part system, message "Executing automatic operation", "Program checking" or "Program restarting" is displayed, but an operation search is not carried out. However, when "#11039 Cusr pos srch type" is set to "1", cursor position search is possible even in the single block stop state. For details, refer to "Search during single block stop" in "10.6.1 Program Editing".
- (8) If the "Edit/Search" window is opened while the operation mode is set to the MDI mode, the MDI program is displayed in the "Edit/Search" window. In this state, if the "Edit/Search" window is closed, the MDI setting at the cursor position is executed.
- (9) The part system that is selected when the "Edit/Search" window is opened is to be searched when the "Edit/Search" window is closed.
- (10) The program that is searched when the "Edit/Search" window is opened is to be searched when the "Edit/Search" window is closed.
- (11) In the following cases, edit/search is not available with the "Edit/Search" window. After an error is displayed, a blank "Edit/Search" window is displayed.
  - Edit lock B, C is enabled
  - Operation search is not carried out
  - Edit file size exceeded
  - A serial program is being searched
- (12) If the edit/search signal is set ON at power ON, the "Edit/Search" window is displayed.
- (13) The "Edit/Search" window cannot be closed with the cancel key. To open another window of the monitor screen, either turn OFF the edit/search signal or use the direct screen selection in the menu list.
- (14) If you switch to the monitor screen to edit using the direct screen selection while the "Edit/Search" window is displayed, the "Edit/Search" window is closed once, a search is carried out, and then the "Edit/Search" window is displayed again.
- (15) If the N number of the block to be searched exceeds the maximum value or is set to "0", it causes a search error in all blocks that belong to the N number.
- (16) If characters other than digits follow "N" of the block to be searched, "N\*\*" of the program is handled as a normal block, not a sequence number. Therefore, if the target block is searched, it is handled as a block that belongs to the previously searched N number.

**Search during single block stop**

Cursor position search can be operated during single block stop when "1" is set to the parameter "#11039 Cusr pos srch type". By pressing menu [Edit] during single block stop, single block stop position becomes top of the program display.

(1) Pause automatic operation with single block stop.

(2) Press the menu [Edit].



The program edit window appears.

The block where the operation is stopped due to single block stop is displayed on the top.

However, for mass-editing, when the program that can be displayed within one page on the edit screen, or when the program has been in single block stop status at the block existing in the first or last page, the cursor is displayed at the stopped block. In these cases, the top or end of the program is displayed, not the stopped block at the head.

If the operation has been stopped in a subprogram, that subprogram is displayed.

(3) Move the cursor to the block to be carried out the cursor operation search.

(4) Press the [INPUT] key.



The search will operate by single block stop position with top.

During the search "Searing" will display blinking.

When the search is completed, "Search completed" is displayed.

**Note**

- (1) Blocks lower than the point of the single block stop only are eligible for cursor position search designation during single block stop. "Search error" will display and the search will fail when cursor position search is attempted at an already executed block.
- (2) The blocks between single block stop position and search position block will be ignored when cycle start is operated after cursor position search is operated during single block stop.
- (3) While the part system with a cursor position search to be performed is in block stop state in arbitrary reverse run mode (including a case in which the reverse run control mode signal is set ON), message "search error" is displayed, and a cursor position search cannot be carried out.
- (4) If the part system with a cursor position search to be performed is placed in block stop state due to a program error, message "During automatic operation" is displayed, and an operation search is not carried out.
- (5) If cursor position search is commanded at a block that causes a program error, the block of the single block stop, instead of the cursor position search target block, will appear on the top of program buffer display upon automatic start up.
- (6) If cursor position search is commanded at a block that comes later than a fixed cycle while stopped with single block stop in the midst of the fixed cycle, the cursor position search target block will appear on the top of the program buffer display. However, automatic operation will start from the top of the remaining of the fixed program, and after finishing the fixed cycle, will move on to executing the cursor search target program.
- (7) If a cursor position search is carried out for blocks after the MTB macro program while the MTB macro program is interrupted by a single block stop, a program buffer is displayed from a search block. However, when the system is started automatically, the MTB macro program is executed continuously, and the block detected by a cursor position search is processed after the MTB macro program has been completed.

10.6.2 Buffer Correction



During automatic operation (Memory, HD, DS, memory card or USB memory) or MDI operation, a block stop can be applied, and the next command can be corrected or changed.

When a program error occurs, the block in which the error occurred can be corrected without resetting the NC, and operation can be continued.

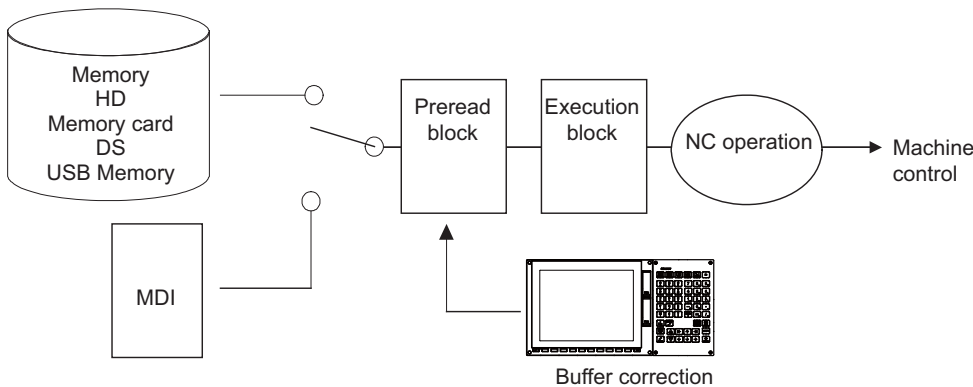
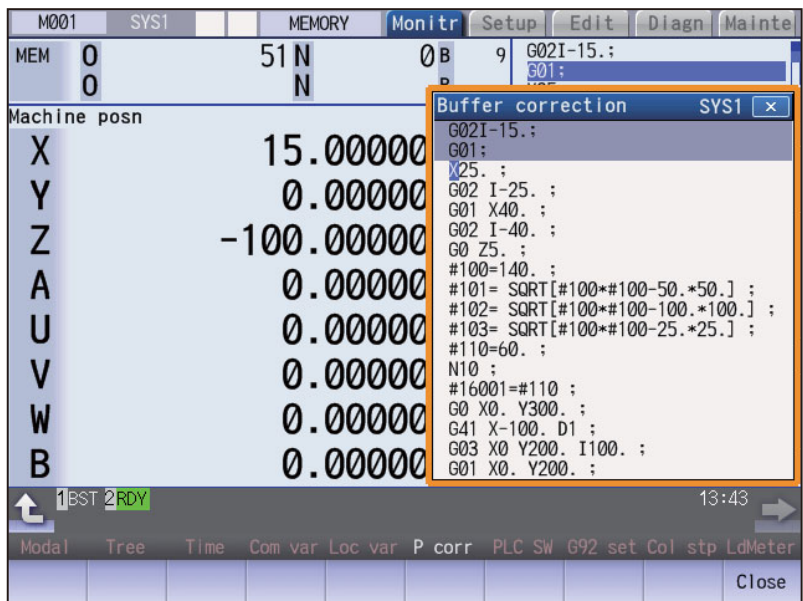

- (1) The next command can be corrected in the following two cases.
  - ◆When single block stop is applied, and there is a command block to be corrected in the next command.
  - ◆When there is an error (program error) in the next command and automatic operation is stopped.
- (2) Not only the displayed buffer data but also the contents in the device are corrected with the buffer corrections. (The corrected data is reflected.)
- (3) Several blocks following the next command can be corrected simultaneously.

| Menus |                                                        |
|-------|--------------------------------------------------------|
| Menus | Details                                                |
| Close | This closes the pop-up window and quits this function. |



**Operation method**

During a single block stop or when a program error stop occurs, the buffer can be corrected with the following operations, and operation can be continued.

The normally executed program appears in the buffer correction area.

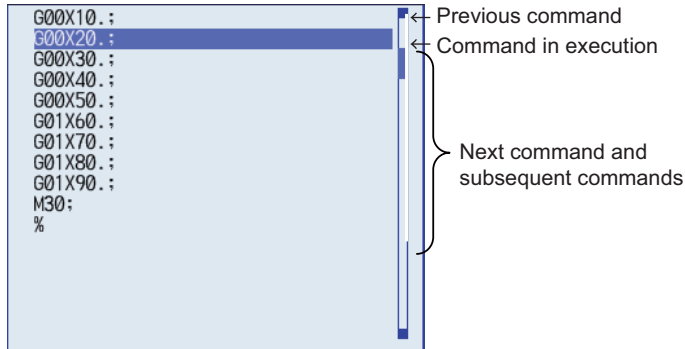

(1) Press the main menu [Prg correct].



The mode changes to the buffer correction mode.

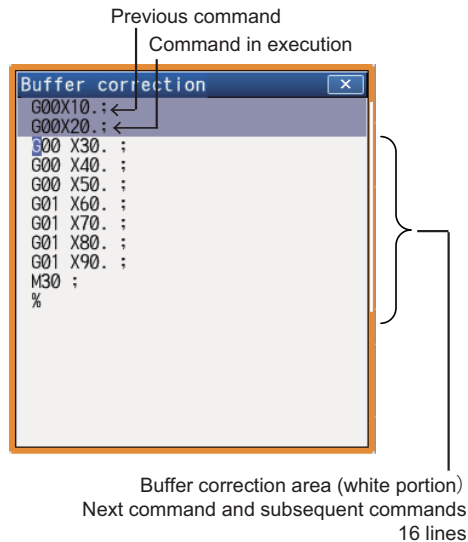

The display changes so that the next command is at the head of the area. The buffer correction area becomes the valid area, and the keys can be input or the cursor moved.

The cursor can be moved freely within the buffer correction area using the cursor keys.

(2) Correct the program with the same method as a normal program editing.

(3) Press the [INPUT] key.



The buffer correction mode ends, and the corrected data is written into program. If a program error has occurred, the error display is erased.

(4) Confirm that the corrected data is correct, and then restart.





The program execution resumes from the currently stopped position.

## Precautions

### ■ Buffer correction mode will not be applied in the following cases:

- (1) Machining program for buffer corrections is in edit lock or program display lock state.
- (2) When the data protection is valid.
- (3) Machining program for the device in write-protection state
- (4) Machining program in read-only state
- (5) During the compound type fixed cycle, the tool center point control or executing the MTB macro program

### ■ Starting and ending buffer corrections

- (1) If automatic operation is started or there is no next command data, the buffer correction mode is not entered even if the menu key is pressed.
- (2) To stop or to cancel the buffer corrections, press the menu [Close] again, or press the  or  key.
- (3) If another menu key, etc., is pressed before pressing the [INPUT] key, the corrected buffer contents return to the original data.
- (4) If changing to another screen or resetting the NC during buffer correction or changing system, the buffer correction is canceled. In this case, the corrected contents are not saved, and the buffer correction mode ends.

### ■ Display data during buffer correction

- (1) The key operations used for corrections in the buffer correction mode are the same as the operations when editing a program. Up to 16 blocks can be displayed. Even when a block is displayed over several lines, all 16 blocks can be displayed by scrolling the buffer correction area. For the 15-type/19-type display unit, 28 blocks are displayed.
- (2) Number of characters in one block is max. 256 (including ";" (EOB)). If exceeds 256 characters, the block will be split into two.
- (3) Up to 4096 characters can be edited with buffer corrections.

### ■ Operations during buffer correction

- (1) If there is no ";" (EOB) at the data in the last block corrected when the [INPUT] key is pressed, it is added automatically.
- (2) When the buffer correction mode is set, the last block displayed in the buffer correction area may not fit in if the block is long, etc.  
To correct this type of block, take care to the following points.
  - ◆ If a ";" (EOB) is added to the end of the displayed data, the section following the incomplete display becomes another block. If ";" (EOB) is not added, the following section stays the same, and is handled as the continuation of the displayed section.
  - ◆ If one block is deleted by pressing the [C.B] key, the block is deleted up to the section following the incomplete display (up to the ";").
- (3) Operation cannot be started during buffer correction. An alarm occurs.
- (4) If NC is reset during buffer correction, buffer correction mode will be canceled, although buffer correction window is left opened. At this time, editing operation is not possible. Close the correction window.
- (5) Buffer correction writing is not interrupted by NC reset.
- (6) The operation message "Can't write into file" appears at any attempt of the buffer mode correction to write into the program being operated or checked, which had stopped when the buffer correction mode started.

### ■ For multi-part system

- (1) When a machining program under buffer correction is called by another part system, a file input/output error occurs to the caller-side part system, and restart of the operation will be disabled.
- (2) Note that if the same program is executed in another part system after a buffer correction, there may be some changes in paths, etc.
- (3) The program which has searched for the sequence No. while operating in another part system cannot be buffer correction. The operation message "Buffer correct not possible" appears.

■ Previous command and command in execution

- (1) When the buffer is corrected following the operation mode change at single block stop, nothing will be displayed in previous command and command in execution.
- (2) When there is no block after sub program call or user macro call, a program error occurs at the last block of the destination program. If a buffer correction is made in this state, the destination program will be displayed in the buffer correction window, but the actual correction result will be reflected on the source program.
- (3) The buffer cannot be corrected when the block where the buffer is corrected is in the forward side from the block called at another nest level. The operation message "Buffer correct not possible" appears.  
The buffer can be corrected when the block where the buffer is corrected is in the rear side from the block called at another nest level.

- (a) : The buffer can be corrected.
- (b)(d) : The buffer can be corrected because the block is in the rear side from (a).
- (c) : The buffer cannot be corrected because the block is in the forward side from (b).

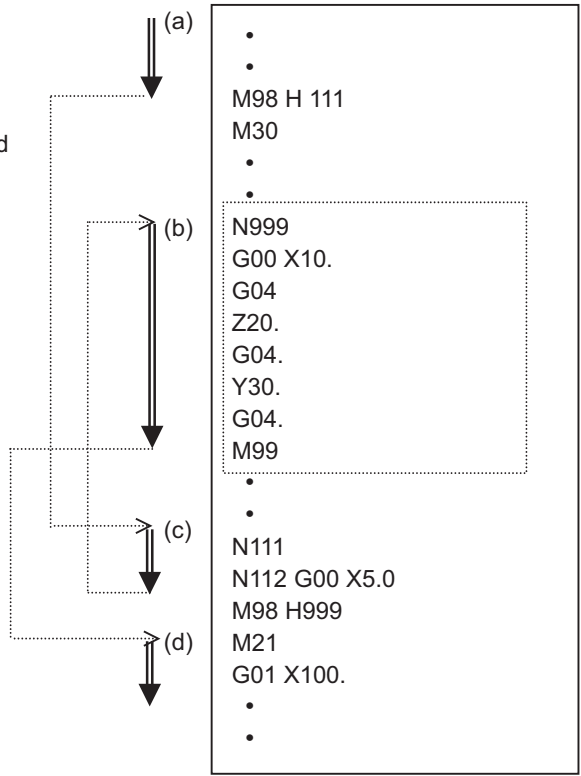

- (4) With buffer correction, as EOB (;) in the comment block is treated as a line feed code, when edited and saved with buffer correction, the program error occurs.

(Example)

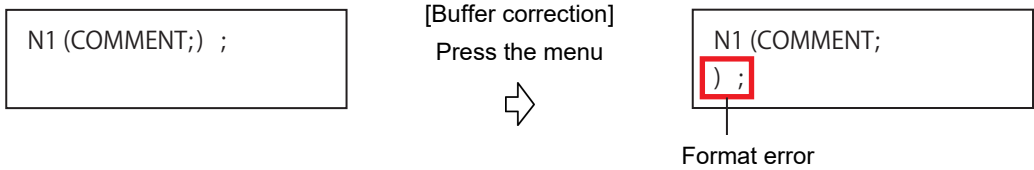

- (5) When the parameter "#19006 EOR Disable" is set to "1", the contents which follows "%" in the program cannot be corrected even though they are displayed.

## Troubleshooting

This chapter explains remedies when any alarm message is displayed, and how to check the NC status. The operations are mainly performed on the diagnosis (Diagn) or maintenance (Mainte) screen.

### 11.1 Confirming the NC Message (Alarm Screen)



A list of currently occurring alarms or messages can be displayed on this screen. The displayed messages include the NC alarms, stop codes, alarm messages, operator messages, etc. A history of alarm information can be displayed also.

#### ■ NC message

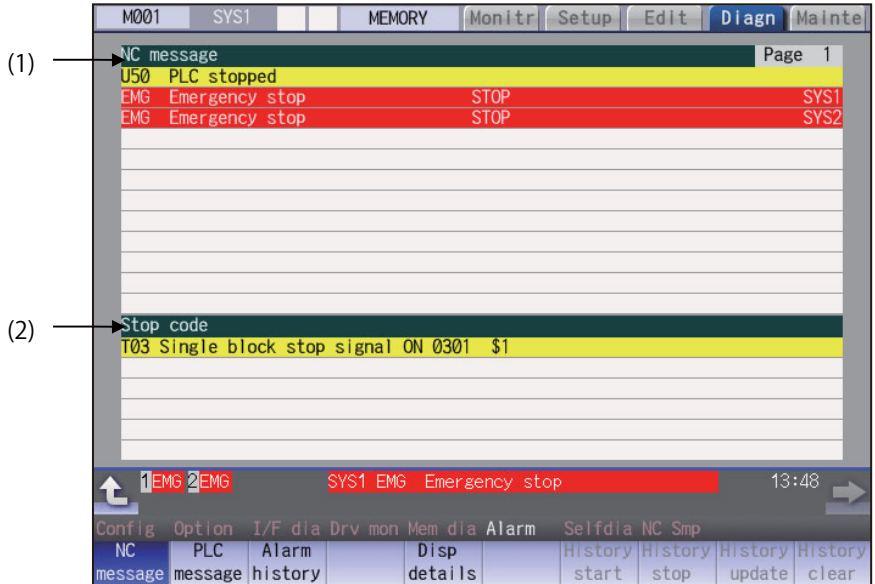

#### ■ PLC message

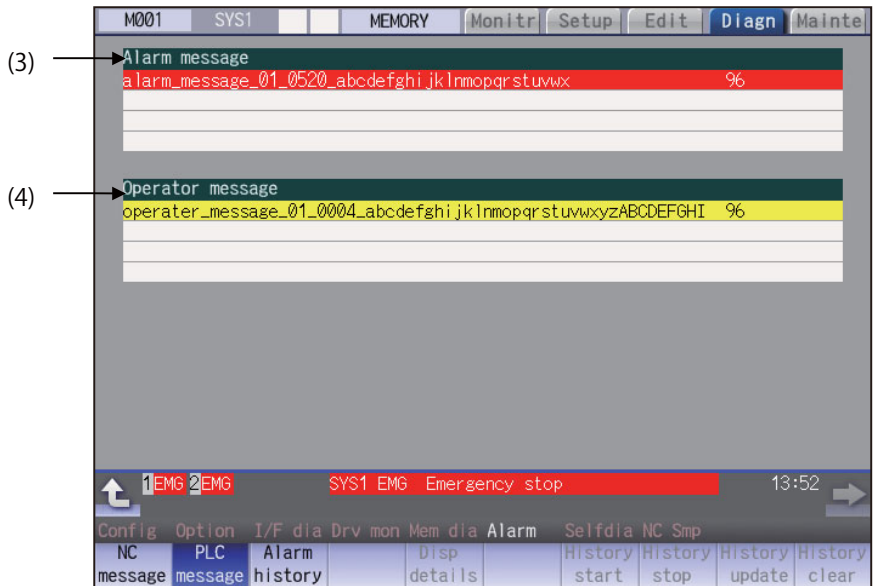

**Display items**

| Display items        | Details                                                                                                                                                                                                            |
|----------------------|--------------------------------------------------------------------------------------------------------------------------------------------------------------------------------------------------------------------|
| (1) NC message       | This displays the operation alarms, program errors, MCP alarms, servo alarms, system alarms, etc.<br>Up to 10 messages are displayed in order of priority.                                                         |
| (2) Stop code        | This displays the automatic operation status or stop status during automatic operation.<br>Up to 4 messages are displayed in order of priority.                                                                    |
| (3) Alarm message    | Using the PLC programs, this displays messages such as details of machine abnormalities. This varies depending on the MTB specifications.<br>Up to 4 messages are displayed.                                       |
| (4) Operator message | Using the PLC programs, this displays operator information messages. This varies depending on the MTB specifications.<br>Macro alarm messages are also displayed in this field.<br>Up to 4 messages are displayed. |

**Note**

(1) When the 2nd line of the operator message cannot be displayed, only the 1st line is displayed.

**Message display colors**

The messages are color-coded in the following manner:

| Message type                             | Character color | Background color |
|------------------------------------------|-----------------|------------------|
| NC message                               | Alarm           | White            |
|                                          | Warning         | Black            |
| Stop code                                | Black           | Yellow           |
| Alarm message                            | White           | Red              |
| Operator message                         | Black           | Yellow           |
| NC alarm message at the background check | White           | Orange           |

**Axis name display**

The axis name is displayed in messages for each axis. The axis name is displayed as shown below according to the axis type.

| Axis type      | Axis name display                               | Display example | Remarks                                                                                  |
|----------------|-------------------------------------------------|-----------------|------------------------------------------------------------------------------------------|
| NC axis        | Control axis name (Name of axis in part system) | XYZ             | If the same message occurs for each part system, several NC axes are displayed together. |
| Spindle        | 'S' + spindle No.                               | S1S2            | If the same message occurs, several spindles are displayed together.                     |
| PLC axis       | 'P' + PLC axis No.                              | P1P2            | If the same message occurs, several PLC axes are displayed together.                     |
| Auxiliary axis | 'A' + auxiliary axis No.                        | A1A2            | If the same message occurs, several auxiliary axes are displayed together.               |

If the same message occurs for different axis types, they will appear as separate messages.

**Part system display**

The part system name is also displayed if the message is output for each part system. The part system name set in "#1169 system name" is displayed. The part system name does not appear for the 1-part system.

## 11.1.1 Alarm History

| M001                       | SYS1    | MEMORY                     | Monitr  | Setup   | Edit  | Diagn   | Mainte  |
|----------------------------|---------|----------------------------|---------|---------|-------|---------|---------|
| Alarm history              |         |                            |         |         |       |         | Page 1  |
| 1012 09:43:11              | EMG     | Emergency stop             | STOP    |         |       | SYS1    |         |
| 1012 09:43:11              | EMG     | Emergency stop             | STOP    |         |       | SYS2    |         |
| 1012 09:43:11              | M01     | Rot axis parameter error   | 0127    |         |       | SYS1    |         |
| 1012 09:43:11              | M01     | No operation mode          | 0101    |         |       | SYS2    |         |
| 1012 09:43:11              | EMG     | Emergency stop             | SPIN    |         |       | SYS1    |         |
| 1012 09:43:11              | EMG     | Emergency stop             | SPIN    |         |       | SYS2    |         |
| 1012 09:43:09              | M01     | H/W stroke end axis exists | 0006    | XYZA    |       | SYS1    |         |
| 1012 09:43:09              | M01     | H/W stroke end axis exists | 0006    | UVWB    |       | SYS2    |         |
| 1012 09:42:30              | EMG     | Emergency stop             | STOP    |         |       | SYS1    |         |
| 1012 09:42:30              | EMG     | Emergency stop             | STOP    |         |       | SYS2    |         |
| 1012 09:42:30              | M01     | Rot axis parameter error   | 0127    |         |       | SYS1    |         |
| 1012 09:42:30              | M01     | No operation mode          | 0101    |         |       | SYS2    |         |
| 1012 09:42:30              | EMG     | Emergency stop             | SPIN    |         |       | SYS1    |         |
| 1012 09:42:30              | EMG     | Emergency stop             | SPIN    |         |       | SYS2    |         |
| 1012 09:42:28              | M01     | H/W stroke end axis exists | 0006    | XYZA    |       | SYS1    |         |
| 1012 09:42:28              | M01     | H/W stroke end axis exists | 0006    | UVWB    |       | SYS2    |         |
| 1 RDY 2 RDY                |         |                            |         |         |       |         | 09:54   |
| SYS2 M01 No operation mode |         |                            |         |         |       |         |         |
| Config                     | Option  | I/F dia                    | Drv mon | Mem dia | Alarm | Selfdia | NC Smp  |
| NC                         | PLC     | Alarm                      |         | Disp    |       | History | History |
| message                    | message | history                    |         | details |       | start   | stop    |
|                            |         |                            |         |         |       | History | History |
|                            |         |                            |         |         |       | update  | clear   |

When an alarm occurs, the alarm information is recorded. When the NC power is ON, an alarm is automatically recorded in alarm history. Alarm information is recorded from the latest alarm to 512.

Alarm information recorded in the history is NC message displayed on "NC message" screen and alarm messages displayed on "PLC message" screen.

The range etc. of record are shown as follows:

Record condition: When an alarm occurs (When two or more alarms occur at the same time, up to five alarms are recorded.)  
 With multi-part system, 1st part system is given priority and recorded. (Following 2nd part system, 3rd part system...)

Number of history: 512 alarms (Whole)



Range of record: NC alarm (alarm, warning), PLC alarm message

### Note

(1) The following alarms are not recorded on the alarm/warning screen.

- Operation alarm
  - External interlock axis exists (M01 0004)
  - Cutting override zero (M01 0102)
  - External feed rate zero (M01 0103)
  - Block start interlock (M01 0109)
  - Cutting block start interlock (M01 0110)
  - Interference check invalidated (M01 0200)
  - Rapid override zero (M01 0125)
  - Sp-Sp polygon (G51.2) cut interlock (M01 1033)
- "U50 PLC stopped" before the HMI screen starts up

## Menus

| Menus          | Details                                                                                                                                                                                                                                                                                                                                                                                                                                                                                                                                       |
|----------------|-----------------------------------------------------------------------------------------------------------------------------------------------------------------------------------------------------------------------------------------------------------------------------------------------------------------------------------------------------------------------------------------------------------------------------------------------------------------------------------------------------------------------------------------------|
| Alarm history  | This displays the first page of the alarm history.<br>The history sequentially displays 16 alarms per page from the latest alarm. If there are two or more NC alarms of same day and time, the alarms are sequentially displayed from the alarm and warning of the 1st part system. To display the old history, press the  key. To display the new history, press the  key. |
| History start  | The data collection of the alarm history is started (restarted).<br>The operation message "The collection begin?(Y/N)" appears. When the [Y] or [INPUT] key is pressed, the data collection is started after the operation message "The collection begin" appears. Press the [N] or other than [INPUT] key when the data collection will be not started/restarted.                                                                                                                                                                            |
| History stop   | The data collection of the alarm history is stopped.<br>The operation message "The collection stop?(Y/N)" appears. When the [Y] or [INPUT] key is pressed, the data collection is stopped after the operation message "The collection stop" appears. Press the [N] or other than [INPUT] key when the data collection will be not stopped.                                                                                                                                                                                                    |
| History update | The alarm information of history is updated.<br>When the history is updated, the page with latest alarm information (first page) is displayed. The history is updated even if changing to another screen, and returning to the alarm history screen.                                                                                                                                                                                                                                                                                          |
| History clear  | The alarm information of history is cleared.<br>The operation message "Execute the collection data clear?(Y/N)" appears. When the [Y] or [INPUT] key is pressed, the alarm information of history is cleared after the operation message "Data clear complete" appears. The first page is displayed when the history is cleared.                                                                                                                                                                                                              |

### Note

- (1) The menus [History start], [History stop], [History update] and [History clear] are valid when the alarm history function is valid and the menu [Alarm history] is selected.
- (2) When the alarm history function is used for the first time, clear the alarm history contents by pressing the menu [History clear]. Unnecessary data may be recorded in the alarm history.

### Precautions

- (1) If the recording of the alarms is stopped with the menu [History stop] in the alarm history screen, alarms are not recorded in the history even after the NC power is turned OFF and ON. In this case, the recording of the alarms must be started with the menu [History start] in the alarm history screen.
- (2) If the time and date are changed, the change is not reflected to the time and date of the history data recorded before the change. Therefore, if the time and date are changed, clear the history with the menu [History clear].
- (3) If an alarm occurs while the alarm history is displayed, the display is not updated. Update the history by switching the screen with the menu [History update].
- (4) Depending on the part system setting of "Sampling spec" in the maintenance diagnostic data collection setting, the part systems to be recorded in the alarm history vary. If "0" is set, alarms of all part systems are recorded.
- (5) The alarm history data collection start/stop operation is switched using the menu [Start] or [Stop] of data collection regardless of whether "Alarm history" is set to "0" or "1" in "Collecting data select" in the maintenance diagnostic data collection setting.



## 11.2 Checking Machine Status

### 11.2.1 System Configuration Screen



Select the menu [Config] on the diagnosis (Diagn) screen to display the hardware configuration (card name and sub-number), software configuration (software number and sub-number), and PLC program configuration (file name, file label, and execution type).

■ Software configuration

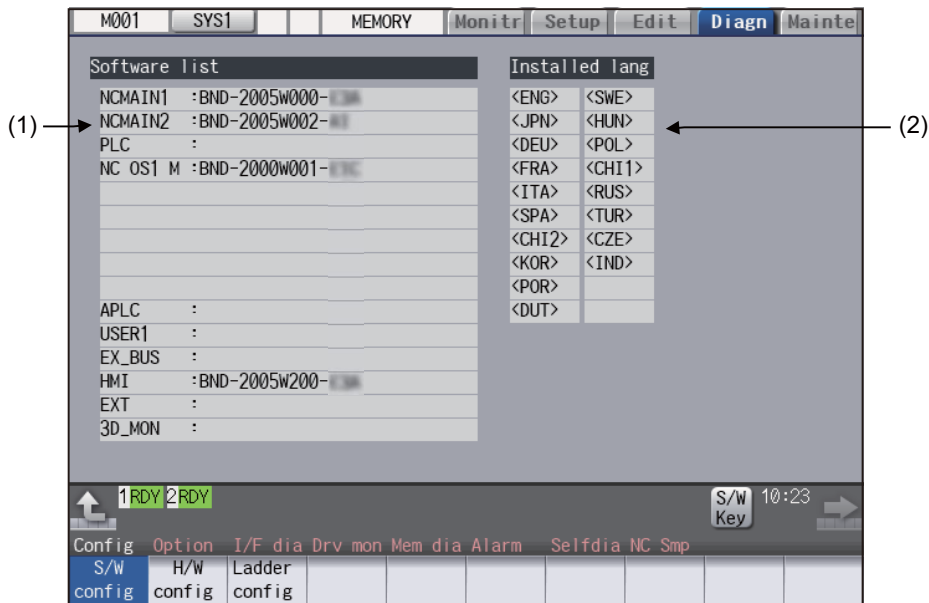

■ Hardware configuration

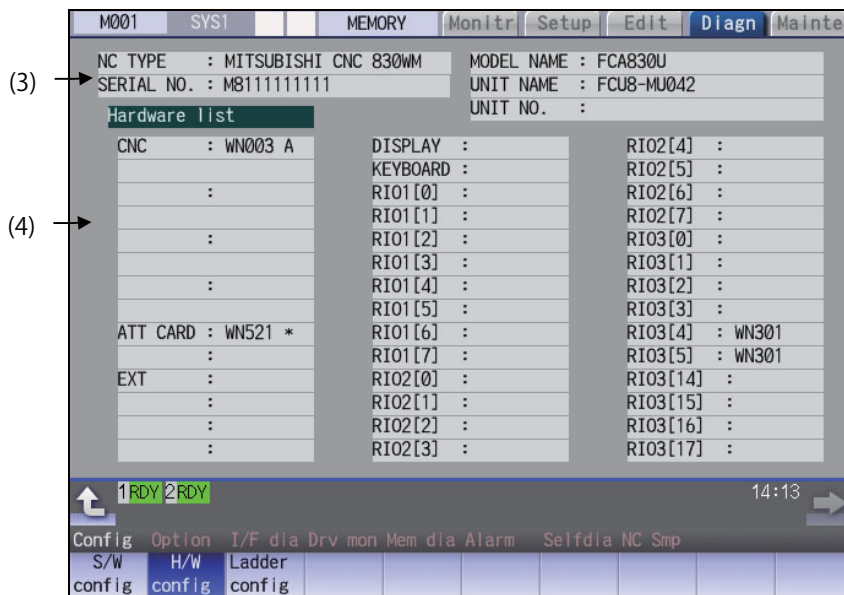



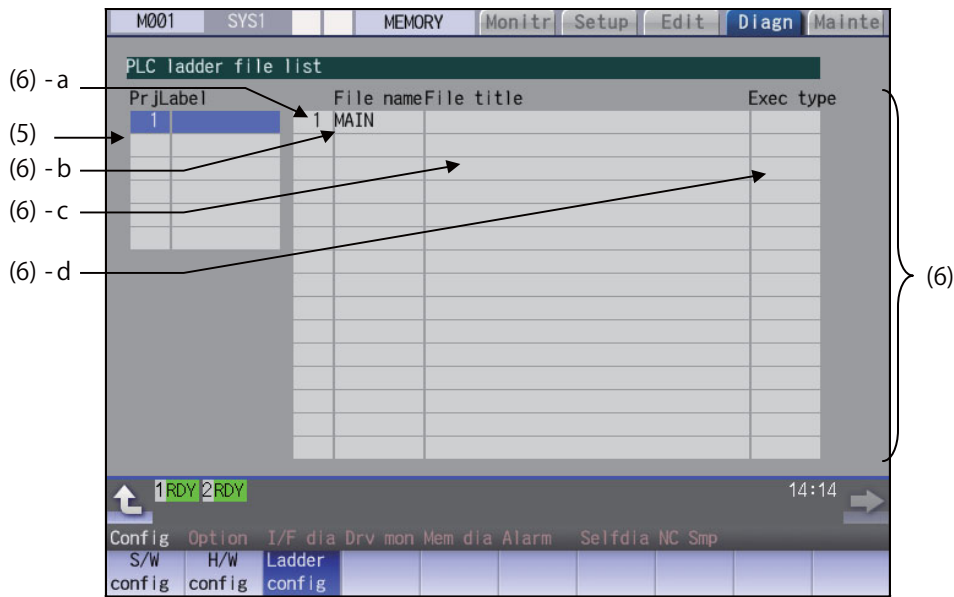

■ PLC program configuration



Display items

| Display items      | Details                                                                                                                                                                                                                                                                                                                                                                                                                                                                                                                                    | Remarks |
|--------------------|--------------------------------------------------------------------------------------------------------------------------------------------------------------------------------------------------------------------------------------------------------------------------------------------------------------------------------------------------------------------------------------------------------------------------------------------------------------------------------------------------------------------------------------------|---------|
| (1) Software list  | This displays a list of the software being used.<br>Use  /  keys to change the pages and refer it.                                                                                                                                                                                                                                                                                                                                                                                                                                         |         |
| (2) Installed lang | This displays a list of installed languages.<br><ENG>: English                      <SWE>: Swedish<br><JPN>: Japanese                      <HUN>: Hungarian<br><DEU>: German                      <POL>: Polish<br><FRA>: French                      <CHI1>: Simplified Chinese<br><ITA>: Italian                      <RUS>: Russian<br><SPA>: Spanish                      <TUR>: Turkish<br><CHI2>: Traditional Chinese      <CZE>: Czech<br><KOR>: Korean                      <IND>: Indonesian<br><POR>: Portuguese<br><DUT>: Dutch |         |
| (3) NC serial No.  | This displays the NC model name, serial No, system type, and unit type.                                                                                                                                                                                                                                                                                                                                                                                                                                                                    |         |
|                    | NC TYPE:                      NC type                                                                                                                                                                                                                                                                                                                                                                                                                                                                                                      |         |
|                    | MODEL NAME:                      System type name                                                                                                                                                                                                                                                                                                                                                                                                                                                                                          |         |
|                    | SERIAL NO.:                      Serial No.                                                                                                                                                                                                                                                                                                                                                                                                                                                                                                |         |
|                    | UNIT NAME:                      Unit type                                                                                                                                                                                                                                                                                                                                                                                                                                                                                                  |         |

| Display items     | Details                                                                                                                                                                                                                                                                                       |                                                                                                                                                                                                                                                                                                    | Remarks                                                                                                                      |
|-------------------|-----------------------------------------------------------------------------------------------------------------------------------------------------------------------------------------------------------------------------------------------------------------------------------------------|----------------------------------------------------------------------------------------------------------------------------------------------------------------------------------------------------------------------------------------------------------------------------------------------------|------------------------------------------------------------------------------------------------------------------------------|
| (4) Hardware list | The hardware names are displayed.<br>Use  /  keys to change the pages and refer it.<br>The following display is an example. |                                                                                                                                                                                                                                                                                                    |                                                                                                                              |
|                   | CNC :WN111<br>:WN891<br>:WN091                                                                                                                                                                                                                                                                | Main card<br>Back panel card<br>7SEG-RSW card<br>♦Existing cards are displayed from the top in the above order.                                                                                                                                                                                    | A single unit of CNC unit is formed with a maximum of 4 PCBs. All of these cards are connected by bus.                       |
|                   | ATT CARD :WN521<br>:                                                                                                                                                                                                                                                                          | Front-side SD IF card                                                                                                                                                                                                                                                                              |                                                                                                                              |
|                   | EXT :WN561<br>:WN563<br>:WN564<br>:WN511                                                                                                                                                                                                                                                      | CC-Link expansion unit<br>PROFIBUS-DP expansion unit<br>CC-Link IE Field unit or EtherNet/IP unit (WN564 and WN511 are one set.)<br><Note><br>For the expansion unit type, refer to the description of expansion unit.<br>♦Existing expansion units are displayed from the top in the above order. | The extension unit is a hardware additional specification.<br>The back panel and maximum of 5 cards are displayed.           |
|                   | DISPLAY :DU191                                                                                                                                                                                                                                                                                | Display unit                                                                                                                                                                                                                                                                                       | The unit type varies by model.                                                                                               |
|                   | KEYBOARD :KB046                                                                                                                                                                                                                                                                               | Keyboard unit                                                                                                                                                                                                                                                                                      | The unit type varies by the keyboard unit being connected.                                                                   |
|                   | ECOMON1 :EMU4-BD1<br>to :EMU4-HD1<br>ECOMON16                                                                                                                                                                                                                                                 | EcoMonitorLight unit                                                                                                                                                                                                                                                                               | The unit type varies depending on the connected EcoMonitor Light unit.<br>The status for up to 16 part systems is displayed. |
|                   | RIO1[n] :WN301<br>RIO2[n] :WN301<br>RIO3[n] :WN301                                                                                                                                                                                                                                            | Remote IO unit 1 (n = 1 to 64)<br>Remote IO unit 2 (n = 1 to 64)<br>Remote IO unit 3 (n = 1 to 64)                                                                                                                                                                                                 | The unit type varies by the remote I/O unit being connected. Maximum of 3 channels are displayed.                            |
| (5) Project       | The list of project Nos. is displayed.<br>If the selected project is switched with [↑] or [↓] key, the list of ladder files that belong to the project is displayed.                                                                                                                          |                                                                                                                                                                                                                                                                                                    | Maximum of 10 single-byte alphanumeric characters for the label                                                              |

| Display items            | Details                                                                                                                                                                                                                                                                                                  | Remarks                                                                                                                                      |
|--------------------------|----------------------------------------------------------------------------------------------------------------------------------------------------------------------------------------------------------------------------------------------------------------------------------------------------------|----------------------------------------------------------------------------------------------------------------------------------------------|
| (6) PLC ladder file list | This displays the file name, file label, execution type for each PLC ladder program.<br>Use  /  keys to change the pages and refer it. |                                                                                                                                              |
| (a) Registration No.     | This displays the registration No. of each PLC program file.                                                                                                                                                                                                                                             | The total number of registration size and target file to be executed for all projects is as follows:<br>M800W/M800S: 120<br>M80W/M80/E80: 60 |
| (b) File name            | This displays the file name of PLC program file.<br>(data of GX Developer/GX Woks2)                                                                                                                                                                                                                      | Max. 8 characters                                                                                                                            |
| (c) File label           | This displays this file label of PLC program file.<br>(data of GX Developer/GX Woks2)                                                                                                                                                                                                                    | Max. 32 characters                                                                                                                           |
| (d) Execution type       | This displays the execution type of PLC program.<br>HIGH: High-speed PLC program<br>MIDDLE: Middle-speed PLC program<br>INTIAL: Initial state of PLC program<br>WAIT: Standby PLC program<br>LOW: Low-speed PLC program<br>(blank): Not the target of the execution.                                     |                                                                                                                                              |

### Menus

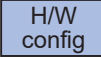
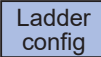
| Menus                                                                               | Details                                                                         |
|-------------------------------------------------------------------------------------|---------------------------------------------------------------------------------|
|  | This displays the software list.                                                |
|  | This displays the hardware list.                                                |
|  | This displays the PLC program list (file name, file label, and execution type). |

### 11.2.2 Option Display Screen



Select the menu [Option] on the diagnosis (Diagn) screen to display the contents of the additional specifications registered in the NC.

The additional specification items are displayed by name. If all of the additional specifications cannot be seen in one screen, the rest of items can be displayed by pressing the page up/down keys.

### Display items

| Display items    | Details                                                                                                                                                                                                                           |
|------------------|-----------------------------------------------------------------------------------------------------------------------------------------------------------------------------------------------------------------------------------|
| (1) Option items | The list of currently usable additional specifications is displayed.<br>As for the currently usable items, the background color is displayed in blue.<br>The items set when the power supply was turned ON can be currently used. |

11.2.3 Drive Monitor Screen (Servo Unit)



The various data related to the servo axis (NC axis, PLC axis) can be monitored by selecting the menus [Drv mon] -> [Servo unit] on the diagnosis (Diagn) screen.

Change the display item with or .

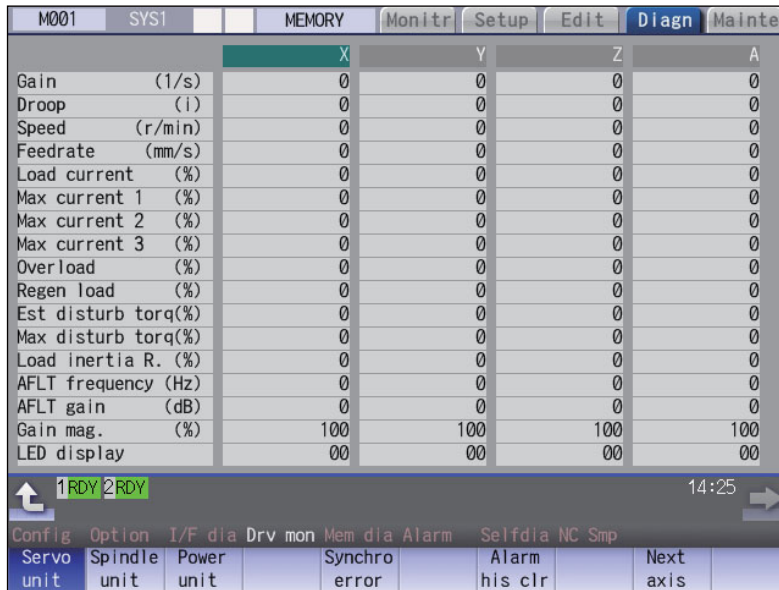

The axis name set in the base axis specification parameter "#1022 axname2" appears at the axis name.

**Display items**

| Display items     | Details                                                                                                                                                                                       |
|-------------------|-----------------------------------------------------------------------------------------------------------------------------------------------------------------------------------------------|
| Gain (1/s)        | This displays the position loop gain. The position loop gain is obtained by the following formula:<br>$\frac{\text{Feedrate (mm/s)}}{\text{Tracking delay error (mm)}}$                       |
| Droop (i)         | The error of the actual machine position to the command position is called droop. This error is proportional to command speed value. This follows the setting and display unit (#1003 iunit). |
| Speed (r/min)     | This displays the actual rotation speed of motor.                                                                                                                                             |
| Feedrate (mm/s)   | This displays the feedrate on the machine end.                                                                                                                                                |
| Load current (%)  | This displays the FB value of the motor current in terms of continuous current during stalling.                                                                                               |
| Max current 1 (%) | This displays the motor current command in terms of continuous current during stalling. An absolute value of the current command peak value sampled after the power ON is displayed.          |
| Max current 2 (%) | This displays the motor current command in terms of continuous current during stalling. An absolute value of the current command peak value sampled in most recent 2 seconds is displayed.    |

| Display items        | Details                                                                                                                                                                                                                                          |
|----------------------|--------------------------------------------------------------------------------------------------------------------------------------------------------------------------------------------------------------------------------------------------|
| Max current 3 (%)    | This displays the FB value of the motor current in terms of continuous current during stalling.<br>An absolute value of the current FB peak value sampled in most recent 2 seconds is displayed.                                                 |
| Overload(%)          | This is the data used to monitor the overload of motor and drive unit.                                                                                                                                                                           |
| Regen load (%)       | This is the data used to monitor the resistance overload state when the resistance regenerative power supply is connected.                                                                                                                       |
| Est disturb torq (%) | This displays the estimated disturbance torque in terms of stall rated torque when the disturbance observer is valid.                                                                                                                            |
| Max disturb torq (%) | This displays the estimated disturbance torque in terms of stall rated torque when the collision detection function is adjusted. An absolute value of the estimated disturbance torque peak value sampled in most recent 2 seconds is displayed. |
| Load inertia R. (%)  | This displays the estimated load inertia ratio when the collision detection function is adjusted.<br>The ratio is displayed according to the parameter settings of "#1251 set23/bit0" and "#2235 V035/bitF".                                     |
| AFLT frequency (Hz)  | This displays the current operation frequency of the adaptive filter.                                                                                                                                                                            |
| AFLT gain (dB)       | This displays the current filter depth of the adaptive filter.                                                                                                                                                                                   |
| Gain mag. (%)        | While Real-time tuning 1 is valid, the currently applied speed control gain is displayed with the magnification for the setting value of speed loop gain 1 (parameter "#2205 SP005 VGN1").                                                       |
| LED display          | This displays the 7-segment LED of the driver.                                                                                                                                                                                                   |
| Alarm                | This displays the alarms and warnings other than the LED display (displayed on drive unit side).                                                                                                                                                 |
| Cycle counter (p)    | This displays the position within one rotation of the encoder detector.<br>The position is displayed within one rotation in the range of "0" to "RNG (movement units) × 1000" using the grid point value as "0".                                 |
| Grid space           | This displays the grid space for the reference position return. (Command unit)                                                                                                                                                                   |
| Grid amnt            | This displays the distance from the dog-off point to the grid point when the dog-type reference position return is displayed. The grid mask amount is not included. (Command unit)                                                               |
| Machine position     | This displays the NC basic machine coordinate system position. (Command unit)                                                                                                                                                                    |
| Motor end FB         | This displays the feedback value of the speed detector. (Command unit)                                                                                                                                                                           |
| Machine end FB       | This displays the feedback position of the machine end position detector. (Command unit)                                                                                                                                                         |
| FB error (i)         | This displays the error of the motor end FB and machine end FB.<br>This follows the setting and display unit (#1003 iunit).                                                                                                                      |
| DFB compen amnt (i)  | This displays the compensation pulse amount during dual feedback control.<br>This follows the setting and display unit (#1003 iunit).                                                                                                            |
| Remain command       | The remaining movement distance of one block is displayed. (Command unit)                                                                                                                                                                        |
| Currnt posn (2)      | The value of the tool compensation amount subtracted from the current position is displayed. (Command unit)                                                                                                                                      |
| Man int amt          | The amount of interrupt movement in the manual absolute OFF state is displayed. (Command unit)                                                                                                                                                   |
| Abs pos command      | The absolute position that does not include the machine error compensation amount is displayed. (Command unit)                                                                                                                                   |
| Superimp syn er (mm) | This displays the current value of the synchronous error between the reference axis and the synchronized axis during control axis synchronization between part systems, control axis superimposition, or arbitrary axis superimposition.         |
| Superimp err +P (mm) | This displays the maximum value of the distance in which the synchronized axis advances beyond the reference axis during control axis synchronization between part systems, control axis superimposition, or arbitrary axis superimposition.     |
| Superimp err -P (mm) | This displays the maximum value of the distance in which the synchronized axis lags behind the reference axis during control axis synchronization between part systems, control axis superimposition, or arbitrary axis superimposition.         |

| Display items             | Details                                                                                                                                                                                                                                                              |
|---------------------------|----------------------------------------------------------------------------------------------------------------------------------------------------------------------------------------------------------------------------------------------------------------------|
| Superimp errP-P (mm)      | This displays the synchronous error width between the reference axis and the synchronized axis during control axis synchronization between part systems, control axis superimposition, or arbitrary axis superimposition.                                            |
| Motor temp. (°C)          | This displays the motor temperature.                                                                                                                                                                                                                                 |
| Power cycles (p)          | This displays the power cycle counter. (Number of times)                                                                                                                                                                                                             |
| Insul resist. (MOhm)      | The insulation degradation status is displayed.                                                                                                                                                                                                                      |
| FAN1 rot. state (%)       | The detected rotation speed of the unit cooling fan is displayed by converting it into percentage format (converted with the rated speed of the fan as 100%).                                                                                                        |
| FAN2 rot. state (%)       | The detected rotation speed of the unit cooling fan is displayed by converting it into percentage format (converted with the rated speed of the fan as 100%).                                                                                                        |
| Battery voltage (V)       | This displays the voltage of the connected battery.                                                                                                                                                                                                                  |
| AUX current sta No. (*1)  | This displays the current station No.                                                                                                                                                                                                                                |
| AUX current posn (*1)     | This displays the current coordinates position.                                                                                                                                                                                                                      |
| AUX inst station No. (*1) | This displays the command station No. of automatic operation or the nearest station No. to stop by manual operation etc.                                                                                                                                             |
| AUX inst posn (*1)        | This displays the coordinates position corresponding to target station No.                                                                                                                                                                                           |
| Mach err comp val         | This displays the machine error compensation amount. (Command unit)                                                                                                                                                                                                  |
| Rot/Spatial err comp      | This displays the amount of rotation center error compensation and spatial error compensation.                                                                                                                                                                       |
| Control input 1L          | This indicates the control signal input from NC to servo. (bit0 to bit7)<br>Bit0: READY ON command<br>Bit1: Servo ON command<br>Bit4: Position loop gain changeover command<br>Bit6: Excessive error detection width changeover command<br>Bit7: Alarm reset command |
| Control input 1H          | This indicates the control signal input from NC to servo. (bit8 to bitF)<br>Bit8: Current limit selection command                                                                                                                                                    |
| Control input 2L          | This indicates the control signal input from NC to servo. (bit0 to bit7)                                                                                                                                                                                             |
| Control input 2H          | This indicates the control signal input from NC to servo. (bit8 to bitF)<br>Bit9: Speed monitor command valid<br>BitA: In door closed (controller)<br>BitB: In door closed (all drive units)                                                                         |
| Control input 3L          | This indicates the control signal input from NC to servo. (bit0 to bit7)<br>Bit0: Control axis detachment command                                                                                                                                                    |
| Control input 3H          | This indicates the control signal input from NC to servo. (bit8 to bitF)                                                                                                                                                                                             |
| Control input 4L          | This indicates the control signal input from NC to servo. (bit0 to bit7)                                                                                                                                                                                             |
| Control input 4H          | This indicates the control signal input from NC to servo. (bit8 to bitF)                                                                                                                                                                                             |
| Control input 5L          | This indicates the control signal input from NC to servo. (bit0 to bit7)                                                                                                                                                                                             |
| Control input 5H          | This indicates the control signal input from NC to servo. (bit8 to bitF)                                                                                                                                                                                             |
| Control input 6L          | This indicates the control signal input from NC to servo. (bit0 to bit7)<br>Bit0: OMR-FF control request                                                                                                                                                             |
| Control input 6H          | This indicates the control signal input from NC to servo. (bit8 to bitF)<br>Bit8: Drivers communication control request                                                                                                                                              |
| Control output 1L         | This indicates the control signal output from servo to NC. (bit0 to bit7)<br>Bit0: In READY ON<br>Bit1: In Servo ON<br>Bit4: In position loop gain changeover<br>Bit6: In excessive error detection width changeover<br>Bit7: In alarm                               |
| Control output 1H         | This indicates the control signal output from servo to NC. (bit8 to bitF)<br>Bit8: In current limit selection<br>BitC: In-position<br>BitD: In current limit<br>BitE: In absolute position data loss<br>BitF: In warning                                             |

| Display items        | Details                                                                                                                                                                                                                                                                                           |
|----------------------|---------------------------------------------------------------------------------------------------------------------------------------------------------------------------------------------------------------------------------------------------------------------------------------------------|
| Control output 2L    | This indicates the control signal output from servo to NC. (bit0 to bit7)<br>Bit0: Z-phase passed<br>Bit3: In zero speed<br>Bit7: In external emergency stop                                                                                                                                      |
| Control output 2H    | This indicates the control signal output from servo to NC. (bit8 to bitF)<br>Bit9: In speed monitor<br>BitA: In door closed (controller)<br>BitB: In door closed (self drive unit)                                                                                                                |
| Control output 3L    | This indicates the control signal output from servo to NC. (bit0 to bit7)<br>Bit0: In control axis detachment                                                                                                                                                                                     |
| Control output 3H    | This indicates the control signal output from servo to NC. (bit8 to bitF)                                                                                                                                                                                                                         |
| Control output 4L    | This indicates the control signal output from servo to NC. (bit0 to bit7)                                                                                                                                                                                                                         |
| Control output 4H    | This indicates the control signal output from servo to NC. (bit8 to bitF)                                                                                                                                                                                                                         |
| Control output 5L    | This indicates the control signal output from servo to NC. (bit0 to bit7)                                                                                                                                                                                                                         |
| Control output 5H    | This indicates the control signal output from servo to NC. (bit8 to bitF)                                                                                                                                                                                                                         |
| Control output 6L    | This indicates the control signal output from servo to NC. (bit0 to bit7)<br>Bit0: In OMR-FF control                                                                                                                                                                                              |
| Control output 6H    | This indicates the control signal output from servo to NC. (bit8 to bitF)<br>Bit8: In drivers communication control                                                                                                                                                                               |
| Detection system     | This displays the detector type symbol of the absolute position detection system.<br>ES: Semi-closed encoder<br>EC: Ball screw end encoder<br>LS: Linear scale<br>MP: MP scale<br>ESS: Semi-closed high-speed serial encoder<br>ECS: Ball screw end high-speed serial encoder<br>INC: Incremental |
| Power OFF posn       | This displays the coordinate at NC power OFF in the basic machine coordinate system. (Command unit)                                                                                                                                                                                               |
| Power ON posn        | This displays the coordinate at NC power ON in the basic machine coordinate system. (Command unit)                                                                                                                                                                                                |
| Current posn         | This displays the current coordinate in the basic machine coordinate system. (Command unit)                                                                                                                                                                                                       |
| R0                   | This displays the multi-rotation counter value of the detector stored in the memory during basic point setting.                                                                                                                                                                                   |
| P0                   | This displays the position within one rotation of the detector stored in the memory during basic point setting.                                                                                                                                                                                   |
| E0                   | This displays the absolute position error stored in the memory during basic point setting.                                                                                                                                                                                                        |
| Rn                   | This displays the multi-rotation counter value of the current detector.                                                                                                                                                                                                                           |
| Pn                   | This displays the position within one rotation of the detector.                                                                                                                                                                                                                                   |
| En                   | This displays the absolute position error during NC power OFF.                                                                                                                                                                                                                                    |
| ABS0                 | This displays the absolute position reference counter.                                                                                                                                                                                                                                            |
| ABSn                 | This displays the current absolute position.                                                                                                                                                                                                                                                      |
| MPOS                 | This displays the offset amount of the MP scale when the power is turned ON.                                                                                                                                                                                                                      |
| Unit type            | This displays the servo driver type.                                                                                                                                                                                                                                                              |
| Unit serial No.      | This displays the servo driver serial No.                                                                                                                                                                                                                                                         |
| Software version     | This displays the servo side software version.                                                                                                                                                                                                                                                    |
| Control method       | SEMI: Semi-closed loop<br>CLOSED: Closed loop<br>DUAL: Dual feedback                                                                                                                                                                                                                              |
| Motor end detector   | This displays the motor end detector type.                                                                                                                                                                                                                                                        |
| Motor end detect No. | This displays the motor end detector serial No.                                                                                                                                                                                                                                                   |



| Display items                                                    | Details                                                                                                                                                                                |
|------------------------------------------------------------------|----------------------------------------------------------------------------------------------------------------------------------------------------------------------------------------|
| Machine end detector                                             | This displays the machine end detector type.<br>The type is displayed when the control method is CLOSED or DUAL. * is displayed when the method is SEMI.                               |
| Mach. end detect No                                              | This displays the machine end detector serial No.                                                                                                                                      |
| Motor                                                            | This displays the motor type.                                                                                                                                                          |
| Work time                                                        | This displays the READY ON work time. (Units: 1 hr)                                                                                                                                    |
| Alarm history<br>1: Time<br>1: Alarm<br>}<br>8: Time<br>8: Alarm | This displays servo alarms that occurred in latest order with the following formats.<br>Time: Work time when the alarm occurred<br>Alarm No.: Number of the servo alarms that occurred |
| Maint hist 1<br>}<br>Maint hist 4                                | This displays the maintenance dates.<br>Year: One digit<br>Month: 1 to 9, X (Oct.), Y (Nov.), Z (Dec.)                                                                                 |
| Maint status                                                     | This displays the maintenance status.                                                                                                                                                  |

(\*1) Data (station No./current position/command position) is displayed for axes of auxiliary axis state.

"-" is displayed for axes of non-auxiliary axis state (NC axis or during PLC axis control).

11.2.4 Drive Monitor Screen (Spindle Unit)

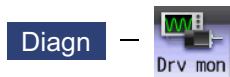

The various data related to the spindle can be monitored by selecting the menus [Drv mon] -> [Spindle unit] on the diagnosis (Diagn) screen.

Change the display item with or .

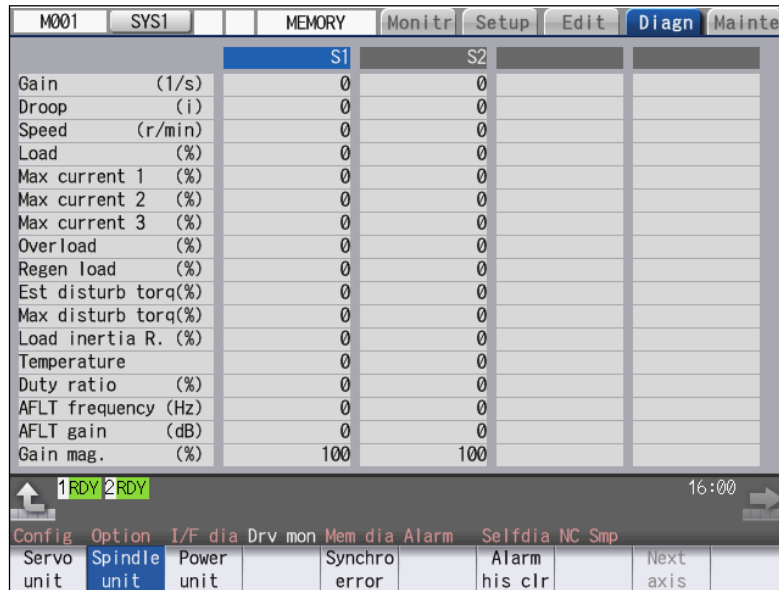

**Display items**

| Display items        | Details                                                                                                                                                                                       |
|----------------------|-----------------------------------------------------------------------------------------------------------------------------------------------------------------------------------------------|
| Gain (1/s)           | This displays the position loop gain. The position loop gain is obtained by the following formula:<br>$\frac{\text{Feedrate (mm/s)}}{\text{Tracking delay error (mm)}}$                       |
| Droop (i)            | The error of the actual machine position to the command position is called droop. This error is proportional to command speed value. (*1)                                                     |
| Speed (r/min)        | This displays the actual rotation speed of motor.                                                                                                                                             |
| Load (%)             | This displays the motor load.                                                                                                                                                                 |
| Max current 1 (%)    | This displays the motor current command in terms of continuous current during stalling. An absolute value of the current command peak value sampled after the power ON is displayed.          |
| Max current 2 (%)    | This displays the motor current command in terms of continuous current during stalling. An absolute value of the current command peak value sampled in most recent 2 seconds is displayed.    |
| Max current 3 (%)    | This displays the FB value of the motor current in terms of continuous current during stalling. An absolute value of the current FB peak value sampled in most recent 2 seconds is displayed. |
| Overload(%)          | This is the data used to monitor the overload of drive unit.                                                                                                                                  |
| Regen load (%)       | This is the data used to monitor the resistance overload state when the resistance regenerative power supply is connected.                                                                    |
| Est disturb torq (%) | This displays the estimated disturbance torque in terms of stall rated torque when the disturbance observer is valid.                                                                         |

| Display items            | Details                                                                                                                                                                                                                                          |
|--------------------------|--------------------------------------------------------------------------------------------------------------------------------------------------------------------------------------------------------------------------------------------------|
| Max disturb torq (%)     | This displays the estimated disturbance torque in terms of stall rated torque when the collision detection function is adjusted. An absolute value of the estimated disturbance torque peak value sampled in most recent 2 seconds is displayed. |
| Load inertia R. (%)      | This displays the estimated load inertia ratio when the collision detection function is adjusted.<br>The ratio is displayed according to the parameter setting of "#1251 set23/bit0".                                                            |
| Temperature (°C)         | This displays the thermistor temperature.<br>The temperature is displayed according to the parameter settings of "#1251 set23/bit0" and "#13225 SP225/bit2".                                                                                     |
| Duty ratio (%)           | This displays the equivalent load ratio of the spindle motor from cycle start of the program to the present.                                                                                                                                     |
| AFLT frequency (Hz)      | This displays the current operation frequency of the adaptive filter.                                                                                                                                                                            |
| AFLT gain (dB)           | This displays the current filter depth of the adaptive filter.                                                                                                                                                                                   |
| Gain mag. (%)            | While Real-time tuning 1 is valid, the currently applied speed control gain is displayed with the magnification for the setting value of speed loop gain 1 (parameter "#13005 SP005 VGN1").                                                      |
| LED display              | This displays the 7-segment LED of the driver.                                                                                                                                                                                                   |
| Alarm                    | This displays the alarms and warnings other than the LED display (displayed on drive unit side).                                                                                                                                                 |
| Cycle counter (p)        | This displays the position within one rotation of the encoder detector.<br>The position is displayed within one rotation in the range of "0" to "RNG (movement units) × 1000" using the grid point value as "0".                                 |
| Grid space               | This displays the grid space for the reference position return. (Command unit) (*1)                                                                                                                                                              |
| Grid amnt                | This displays the distance from the dog-off point to the grid point when the dog-type reference position return is displayed. The grid mask amount is not included. (Command unit) (*1)                                                          |
| Machine position         | This displays the NC basic machine coordinate system position. (Command unit) (*1)                                                                                                                                                               |
| Motor end FB             | This displays the feedback value of the speed detector. (Command unit) (*1)                                                                                                                                                                      |
| FB error (i)             | This displays the error of the motor end FB and machine end FB. (*1)                                                                                                                                                                             |
| DFB compen amnt (i)      | This displays the compensation pulse amount during dual feedback control. (*1)                                                                                                                                                                   |
| Tap error (mm) (*2)      | This displays the current value of the synchronous error between the tapping spindle and the drilling axis during synchronous tapping.<br>(When the parameter "#1041 Initial inch" is set to "1", "Tap error (inch)" is displayed.) (*1)         |
| Tap error +P (mm) (*2)   | This displays the maximum value of the distance in which the drilling axis advances beyond the tapping spindle during synchronous tapping.<br>(When the parameter "#1041 Initial inch" is set to "1", "Tap error +P (inch)" is displayed.) (*1)  |
| Tap error -P (mm) (*2)   | This displays the maximum value of the distance in which the drilling axis lags behind the tapping spindle during synchronous tapping.<br>(When the parameter "#1041 Initial inch" is set to "1", "Tap error -P (inch)" is displayed.) (*1)      |
| Tap error P-P (mm) (*2)  | This displays the synchronous error width between the spindle and the drilling axis during the synchronous tapping.<br>(When the parameter "#1041 Initial inch" is set to "1", "Tap error -P (inch)" is displayed.) (*1)                         |
| Tap error (deg) (*2)     | This displays the current value of the synchronous error angle between the tapping spindle and the drilling axis during synchronous tapping. (±99999.999 deg) (*1)                                                                               |
| Tap error +P (deg) (*2)  | This displays the maximum value of the angle at which the tapping spindle advances beyond the drilling axis during synchronous tapping. (±99999.999 deg) (*1)                                                                                    |
| Tap error -P (deg) (*2)  | This displays the maximum value of the angle at which the tapping spindle lags behind the drilling axis during synchronous tapping. (±99999.999 deg) (*1)                                                                                        |
| Tap error P-P (deg) (*2) | This displays the synchronous error angle between the spindle and the drilling axis during the synchronous tapping. (deg) (*1)                                                                                                                   |
| SP sync error (deg)      | This displays the current value of the synchronous error between the reference spindle and the synchronized spindle during spindle synchronization I, tool spindle synchronization IA/IB, or tool spindle synchronization II. (±99999.999 deg)   |

| Display items         | Details                                                                                                                                                                                                                                                                                                |
|-----------------------|--------------------------------------------------------------------------------------------------------------------------------------------------------------------------------------------------------------------------------------------------------------------------------------------------------|
| SP sync err +P (deg)  | This displays the maximum value of the angle at which the synchronized spindle advances beyond the reference spindle during spindle synchronization I, tool spindle synchronization IA/IB, or tool spindle synchronization II. ( $\pm 99999.999$ deg)                                                  |
| SP sync err -P (deg)  | This displays the maximum value of the angle at which the synchronized spindle lags behind the reference spindle during spindle synchronization I, tool spindle synchronization IA/IB, or tool spindle synchronization II. ( $\pm 99999.999$ deg)                                                      |
| SP syn err P-P (deg)  | This displays the synchronous error width between the reference spindle and the synchronized spindle during spindle synchronization I, tool spindle synchronization IA/IB, or tool spindle synchronization II. ( $\pm 99999.999$ deg)                                                                  |
| SP syn phas er (deg)  | This displays the phase difference stored in the memory by calculating the phase shift value. ( $\pm 99999.999$ deg)                                                                                                                                                                                   |
| SP sync ph1 FB (deg)  | This displays the current value of the feedback phase difference that includes the phase difference stored in the memory by calculating the phase shift value during spindle synchronization I, tool spindle synchronization IA/IB, or tool spindle synchronization II. ( $\pm 99999.999$ deg)         |
| SP sync ph2 FB (deg)  | This displays the current value of the feedback phase difference that does not include the phase difference stored in the memory by calculating the phase shift value during spindle synchronization I, tool spindle synchronization IA/IB, or tool spindle synchronization II. ( $\pm 99999.999$ deg) |
| SP syn er comp (deg)  | This displays the error compensation amount during spindle synchronization I, tool spindle synchronization IA/IB, or tool spindle synchronization II. ( $\pm 99999.999$ deg)                                                                                                                           |
| GB sync error (deg)   | This displays the current value of the synchronous error between the reference spindle and the guide bushing spindle during guide bushing spindle synchronization. ( $\pm 99999.999$ deg)                                                                                                              |
| GB sync err +P (deg)  | This displays the maximum value of the distance in which the guide bushing spindle advances beyond the reference spindle during guide bushing spindle synchronization. ( $\pm 99999.999$ deg)                                                                                                          |
| GB sync err -P (deg)  | This displays the maximum value of the distance in which the guide bushing spindle lags behind the reference spindle during guide bushing spindle synchronization. ( $\pm 99999.999$ deg)                                                                                                              |
| GB sync err P-P (deg) | This displays the synchronous error width between the reference spindle and the guide bushing spindle during guide bushing spindle synchronization. ( $\pm 99999.999$ deg)                                                                                                                             |
| Motor temp. (°C)      | This displays the motor temperature.                                                                                                                                                                                                                                                                   |
| Power cycles (p)      | This displays the power cycle counter. (Number of times)                                                                                                                                                                                                                                               |
| Insul resist. (MOhm)  | The insulation degradation status is displayed.                                                                                                                                                                                                                                                        |
| FAN1 rot. state (%)   | The detected rotation speed of the unit cooling fan is displayed by converting it into percentage format (converted with the rated speed of the fan as 100%).                                                                                                                                          |
| FAN2 rot. state (%)   | The detected rotation speed of the unit cooling fan is displayed by converting it into percentage format (converted with the rated speed of the fan as 100%).                                                                                                                                          |
| Battery voltage (V)   | This displays the battery voltage.                                                                                                                                                                                                                                                                     |
| Control input 1L      | This indicates the control signal input from NC to spindle. (bit0 to bit7)<br>Bit0: READY ON command<br>Bit1: Servo ON command<br>Bit7: Alarm reset command                                                                                                                                            |
| Control input 1H      | This indicates the control signal input from NC to spindle. (bit8 to bitF)<br>Bit8 to BitA: Torque limit selection command                                                                                                                                                                             |
| Control input 2L      | This indicates the control signal input from NC to spindle. (bit0 to bit7)                                                                                                                                                                                                                             |
| Control input 2H      | This indicates the control signal input from NC to spindle. (bit8 to bitF)<br>Bit9: Speed monitor command valid<br>BitA: In door closed (controller)<br>BitB: In door closed (all drive unit)                                                                                                          |
| Control input 3L      | This indicates the control signal input from NC to spindle. (bit0 to bit7)                                                                                                                                                                                                                             |
| Control input 3H      | This indicates the control signal input from NC to spindle. (bit8 to bitF)                                                                                                                                                                                                                             |
| Control input 4L      | This indicates the control signal input from NC to spindle. (bit0 to bit7)<br>Bit0 to Bit2: Spindle control mode selection command<br>Bit4: In gear changeover command<br>Bit5 to Bit6: Gear selection command                                                                                         |

| Display items     | Details                                                                                                                                                                                                                                                              |
|-------------------|----------------------------------------------------------------------------------------------------------------------------------------------------------------------------------------------------------------------------------------------------------------------|
| Control input 4H  | This indicates the control signal input from NC to spindle. (bit8 to bitF)<br>BitC: M coil selection command<br>BitD: L coil selection command<br>BitE: Sub-motor selection command                                                                                  |
| Control input 5L  | This indicates the control signal input from NC to spindle. (bit0 to bit7)                                                                                                                                                                                           |
| Control input 5H  | This indicates the control signal input from NC to spindle. (bit8 to bitF)<br>BitB: Minimum excitation 2 changeover request<br>BitC: Speed gain set 2 changeover request<br>BitD: Zero point re-detection request<br>BitE: Increase holding power of spindle         |
| Control input 6L  | This indicates the control signal input from NC to spindle. (bit0 to bit7)<br>Bit0: OMR-FF control request                                                                                                                                                           |
| Control input 6H  | This indicates the control signal input from NC to spindle. (bit8 to bitF)<br>Bit8: Drivers communication control request                                                                                                                                            |
| Control output 1L | This indicates the control signal input from spindle to NC. (bit0 to bit7)<br>Bit0: In READY ON<br>Bit1: In Servo ON<br>Bit7: In alarm                                                                                                                               |
| Control output 1H | This indicates the control signal input from spindle to NC. (bit8 to bitF)<br>Bit8 to BitA: In torque limit selection<br>BitC: In-position<br>BitD: In torque limit<br>BitF: In warning                                                                              |
| Control output 2L | This indicates the control signal input from spindle to NC. (bit0 to bit7)<br>Bit0: Z phase passed<br>Bit3: In zero speed<br>Bit7: In external emergency stop                                                                                                        |
| Control output 2H | This indicates the control signal input from spindle to NC. (bit8 to bitF)<br>Bit9: In speed monitor<br>BitA: In door closed (controller)<br>BitB: In door closed (self drive unit)                                                                                  |
| Control output 3L | This indicates the control signal input from spindle to NC. (bit0 to bit7)                                                                                                                                                                                           |
| Control output 3H | This indicates the control signal input from spindle to NC. (bit8 to bitF)                                                                                                                                                                                           |
| Control output 4L | This indicates the control signal input from spindle to NC. (bit0 to bit7)<br>Bit0 to Bit2: In spindle control mode selection<br>Bit4: In gear changeover command<br>Bit5 to Bit6: In gear selection<br>Bit7: Magnetic pole position not set                         |
| Control output 4H | This indicates the control signal input from spindle to NC. (bit8 to bitF)<br>BitD: In L coil selection                                                                                                                                                              |
| Control output 5L | This indicates the control signal input from spindle to NC. (bit0 to bit7)<br>Bit0: Current detection<br>Bit1: Speed detection<br>Bit6: In coil changeover                                                                                                           |
| Control output 5H | This indicates the control signal input from spindle to NC. (bit8 to bitF)<br>Bit9: 2nd speed detection<br>BitB: In minimum excitation rate 2 selection<br>BitC: In speed gain set 2 selection<br>BitD: Zero point re-detection complete<br>BitF: In 2nd in-position |
| Control output 6L | This indicates the control signal input from spindle to NC. (bit0 to bit7)<br>Bit0: In OMR-FF control                                                                                                                                                                |
| Control output 6H | This indicates the control signal input from spindle to NC. (bit8 to bitF)<br>Bit8: In drivers communication control                                                                                                                                                 |
| Unit type         | This displays the spindle type.                                                                                                                                                                                                                                      |
| Unit serial No.   | This displays the spindle serial No.                                                                                                                                                                                                                                 |
| Software version  | This displays the software No. and version on the spindle side.                                                                                                                                                                                                      |

| Display items                                                    | Details                                                                                                                                                                                |
|------------------------------------------------------------------|----------------------------------------------------------------------------------------------------------------------------------------------------------------------------------------|
| Motor end detect No                                              | This displays the motor end detector serial No.                                                                                                                                        |
| Mach. end detect No                                              | This displays the machine end detector serial No.                                                                                                                                      |
| Motor                                                            | It displays the motor type which is set for the spindle specification parameter "#3138 motor_type".<br>The maximum of 26 words are displayed with 2 lines and left aligned.            |
| Work time                                                        | This displays the READY ON work time. (Units: 1 hr)                                                                                                                                    |
| Alarm history<br>1: Time<br>1: Alarm<br>}<br>8: Time<br>8: Alarm | This displays servo alarms that occurred in latest order with the following formats.<br>Time: Work time when the alarm occurred<br>Alarm No.: Number of the servo alarms that occurred |
| Maint hist 1<br>}<br>4                                           | This displays the maintenance dates.<br>Year: One digit<br>Month: 1 to 9, X (Oct.), Y (Nov.), Z (Dec.)                                                                                 |
| Maint status                                                     | This displays the maintenance status.                                                                                                                                                  |

(\*1) These follow the setting and display unit (#1003 iunit) of the 1st part system.

(\*2) Synchronous tapping error

This displays the maximum values of the synchronous tapping error that occur during the synchronous tapping.

The synchronous tapping error means the motor tracking delay for the commanded positions of the spindle and the tapping axis.

The positive synchronous tapping error means that the tapping axis is delayed responding to the spindle, and the negative synchronous tapping error means that the spindle is delayed responding to the tapping axis.

| Data name                                   | Details                                                                                                                                                                                                                                                                                                                                                                                                           |
|---------------------------------------------|-------------------------------------------------------------------------------------------------------------------------------------------------------------------------------------------------------------------------------------------------------------------------------------------------------------------------------------------------------------------------------------------------------------------|
| Synchronous tapping error width (Max value) | <ul style="list-style-type: none"> <li>◆This outputs the data of which absolute value is the largest among the synchronous tapping error width (-99999.999 to 99999.999 mm) during the synchronous tapping modal.</li> <li>◆This data will be initialized to "0" when entering the synchronous tapping modal or restoring the power. Other than that, the data continues to display the maximum value.</li> </ul> |
| Synchronous tapping error angle (Max value) | <ul style="list-style-type: none"> <li>◆This outputs the data of which absolute value is the largest among the synchronous tapping error angle (-99999.999 to 99999.999°) during the synchronous tapping modal.</li> <li>◆This data will be initialized to "0" when entering the synchronous tapping modal or restoring the power. Other than that, the data continues to display the maximum value.</li> </ul>   |

## 11.2.5 Drive Monitor Screen (Power Supply Unit)



The various data related to the power supply can be monitored by selecting the menus [Drv mon] -> [Power unit] on the diagnosis (Diagn) screen.

Change the display item with or .

| M001                |  | SYS1 |  | MEMORY |   | Monitr |  | Setup |  | Edit |  | Diagn |  | Mainte |  |
|---------------------|--|------|--|--------|---|--------|--|-------|--|------|--|-------|--|--------|--|
| PW1                 |  |      |  |        |   |        |  |       |  |      |  |       |  |        |  |
| Unit type           |  |      |  |        |   |        |  |       |  |      |  |       |  |        |  |
| Unit serial No.     |  |      |  |        |   |        |  |       |  |      |  |       |  |        |  |
| Software version    |  |      |  |        |   |        |  |       |  |      |  |       |  |        |  |
| Connected drive     |  |      |  |        |   |        |  |       |  |      |  |       |  |        |  |
| Recovery energy(kW) |  |      |  |        | 0 |        |  |       |  |      |  |       |  |        |  |
| Pw. sply volt(Vrms) |  |      |  |        | 0 |        |  |       |  |      |  |       |  |        |  |
| PN bus voltage (V)  |  |      |  |        | 0 |        |  |       |  |      |  |       |  |        |  |
| Min PN bus volt (V) |  |      |  |        | 0 |        |  |       |  |      |  |       |  |        |  |
| Min PN current (%)  |  |      |  |        | 0 |        |  |       |  |      |  |       |  |        |  |
| Bus current (%)     |  |      |  |        | 0 |        |  |       |  |      |  |       |  |        |  |
| Max current1 (%)    |  |      |  |        | 0 |        |  |       |  |      |  |       |  |        |  |
| Max current2 (%)    |  |      |  |        | 0 |        |  |       |  |      |  |       |  |        |  |
| Max rgn current1(%) |  |      |  |        | 0 |        |  |       |  |      |  |       |  |        |  |
| Max rgn current2(%) |  |      |  |        | 0 |        |  |       |  |      |  |       |  |        |  |
| No. of instant stop |  |      |  |        | 0 |        |  |       |  |      |  |       |  |        |  |
| Work time           |  |      |  |        | 0 |        |  |       |  |      |  |       |  |        |  |

1 RDY 2 RDY 14:30

Config Option I/F dia Drv mon Mem dia Alarm Self dia NC Smp

Servo unit Spindle unit Power unit Synchro error Alarm his clr Next axis

## Display items

| Display items        | Details                                                                                                        |
|----------------------|----------------------------------------------------------------------------------------------------------------|
| Unit type            | This displays the power supply unit type.                                                                      |
| Unit serial No.      | This displays the serial No. of the power supply unit.                                                         |
| Software version     | This displays the software version.                                                                            |
| Connected drive      | This displays the I/F channel No. (mcp_no, smcp_no) of the drive unit connected to each power supply unit.     |
| Recovery energy (KW) | This displays the regenerative power every two seconds. (0 to 999 kW)                                          |
| Pw. sply volt (Vrms) | This displays the effective value of the power supply voltage. (0 to 999 Vrms)                                 |
| PN bus voltage (V)   | This displays PN bus voltage. (0 to 999V)                                                                      |
| Min PN bus volt (V)  | This displays the minimum PN bus voltage after the NC power ON. (0 to 999V)                                    |
| Min PN current (%)   | This displays the bus current when PN bus voltage is at minimum. (driving: +, regenerative: -) (0 to 999%)     |
| Bus current (%)      | This displays the bus current. (driving: +, regenerative: -) (0 to 999%)                                       |
| Max current1 (%)     | This displays the maximum driving current after the NC power ON. (0 to 999%)                                   |
| Max current2 (%)     | This displays the maximum driving current in most recent 2 seconds. (0 to 999%)                                |
| Max rgn current1 (%) | This displays the maximum regenerative current after the NC power ON. (0 to 999%)                              |
| Max rgn current2 (%) | This displays the maximum regenerative current in most recent 2 seconds. (0 to 999%)                           |
| No. of instant stop  | This displays the number of instantaneous power interruption exceeding 1 cycle of the power. (0 to 9999 times) |
| Work time            | This displays the READY ON work time. (Units: 1 hr)                                                            |
| Power-run pwr (kW)   | The power-run power is calculated and displayed. (0.01 kW)                                                     |
| Regenerate pwr (kW)  | The regenerated power is calculated and displayed. (0.01 kW)                                                   |

| Display items                                                    | Details                                                                                                                                                                                |
|------------------------------------------------------------------|----------------------------------------------------------------------------------------------------------------------------------------------------------------------------------------|
| Consumed power (kW)                                              | The power consumption is calculated and its integrated value is displayed. (0.01 kWh)                                                                                                  |
| Pwr. distortion (V)                                              | The amount of power distortion (harmonic voltage value) is calculated and displayed. (V)                                                                                               |
| Supplied power (kW)                                              | The supplied power is calculated and displayed. (kW)                                                                                                                                   |
| Accum. power (kWh)                                               | The accumulated power is calculated and displayed. (kWh)                                                                                                                               |
| Harmonic volt. (V)                                               | The power line harmonic voltage is displayed. (V)                                                                                                                                      |
| CV margin (%)                                                    | The CV margin is calculated and displayed. (%)                                                                                                                                         |
| FAN1 rot. state (%)                                              | The detected rotation speed of the unit cooling fan is displayed by converting it into percentage format (converted with the rated speed of the fan as 100%).                          |
| FAN2 rot. state (%)                                              | The detected rotation speed of the unit cooling fan is displayed by converting it into percentage format (converted with the rated speed of the fan as 100%).                          |
| Alarm history<br>1: Time<br>1: Alarm<br>}<br>8: Time<br>8: Alarm | This displays servo alarms that occurred in latest order with the following formats.<br>Time: Work time when the alarm occurred<br>Alarm No.: Number of the servo alarms that occurred |
| Maint hist 1<br>}<br>4                                           | This displays the maintenance dates.<br>Year: One digit<br>Month: 1 to 9, X (Oct.), Y (Nov.), Z (Dec.)                                                                                 |
| Maint status                                                     | This displays the maintenance status.                                                                                                                                                  |



11.2.6 Drive Monitor Screen (Synchronous Error)



The "Synchronous error" appears only when the synchronous control axis specification is valid.

The various data related to the synchronous error can be monitored by selecting the menus [Drv mon] -> [Synchro error] on the diagnosis (Diagn) screen.



Display items





| Display items    | Details                                                                                                                                                                                                                                                                                                                                                                                                                                                                                                                                                                 |
|------------------|-------------------------------------------------------------------------------------------------------------------------------------------------------------------------------------------------------------------------------------------------------------------------------------------------------------------------------------------------------------------------------------------------------------------------------------------------------------------------------------------------------------------------------------------------------------------------|
| Slave axis       | This displays the slave axis name which is controlled following the master axis. The axis name corresponding to the axis No. set in the axis specification parameter "#1068 slavno" (slave axis No.) is displayed. The name set in the base axis specification parameter "#1022 axname2" (2nd axis name) is displayed for the slave axis.                                                                                                                                                                                                                               |
| Command error    | This is the deviation of the slave axis machine position in respect to the master axis. The error of the commanded position to the servo control section before pitch error compensation, relative position compensation and backlash compensation is displayed. If this error occurs, the parameters that should be the same for the synchronous axes are different.<br>Command error = Command s - command m - Δ<br>Command s: Slave axis commanded position<br>Command m: Master axis commanded position<br>Δ: Command s - command m at start of synchronous control |
| FB error         | This is the deviation of the slave axis feedback position in respect to the feedback position from the master axis servomotor. The actual error of the machine position is displayed. The synchronous error check is carried out on this error.<br>FB error = FBs - FBm - Δ<br>FBs: Slave axis feedback position<br>FBm: Master axis feedback position<br>Δ: FBs - FBm at start of synchronous control                                                                                                                                                                  |
| FB error MAX1    | This displays the maximum FB error after the start of the synchronous control.                                                                                                                                                                                                                                                                                                                                                                                                                                                                                          |
| FB error MAX2    | This displays the maximum FB error approx. every 30 seconds after the start of the synchronous control.                                                                                                                                                                                                                                                                                                                                                                                                                                                                 |
| Machine position | This displays the commanded machine position for the master axis.                                                                                                                                                                                                                                                                                                                                                                                                                                                                                                       |

## 11.2.7 Clearing the Alarm History on Drive Monitor Screen



---

**Operation method**

- (1) Press the menu [Servo unit], [Spindle unit] or [Power unit].
- (2) Using the menu [Next axis], tab keys  and , select the axis (device) from which to clear the alarm history.
- (3) Press the menu [Alarm his clr].
  -  The menu is highlighted, and a message appears to confirm the erasing.  
The alarm history1: Time appears at the head.
- (4) Press the [Y] key.
  -  All alarm history data for the selected axis (device) are cleared to "0".

### 11.3 Diagnosis Screens

#### 11.3.1 Self Diagnosis Screen



The hardware state and NC operation state can be confirmed by selecting the menu [Selfdia] on the diagnosis (Diagn) screen.

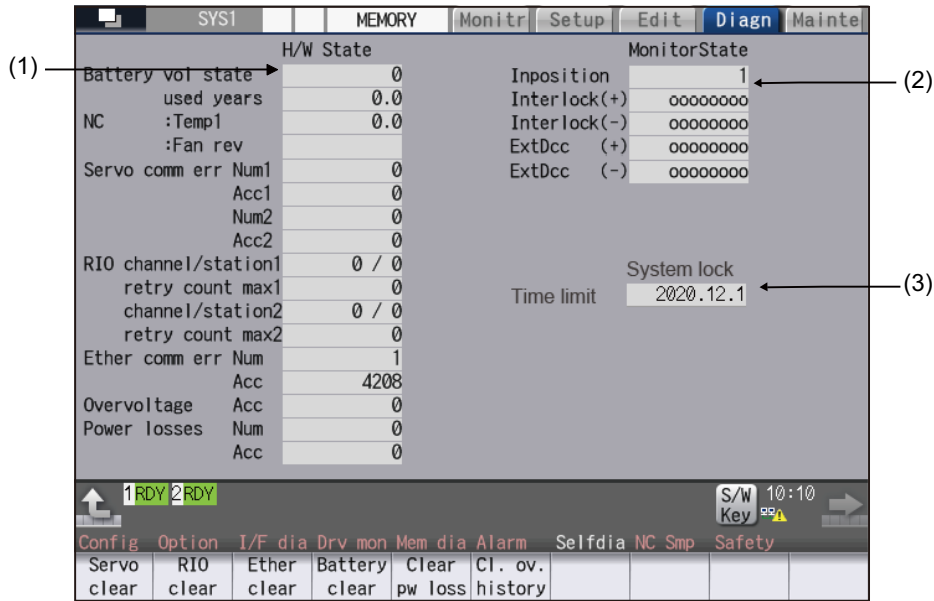

**Display items**

| Display items                                | Details                                                                                                                                                                                                                                                                                                                               |
|----------------------------------------------|---------------------------------------------------------------------------------------------------------------------------------------------------------------------------------------------------------------------------------------------------------------------------------------------------------------------------------------|
| (1) H/W state (common for part systems)      | This displays the hardware state of the NC unit and display unit. (*1)                                                                                                                                                                                                                                                                |
| (2) Operation state (Depends on part system) | This displays the state when the operation seems to be stopped in spite that the alarm does not occur. (*2)                                                                                                                                                                                                                           |
| (3) System lock                              | This displays the valid term by the system lock when the system lock is valid. This will not displayed when the system lock specification is invalid. Once the expiry date is passed, cycle start is disabled. You can set a new time limit or cancel the currently set time limit by entering the decryption code issued by the MTB. |

(\*1) As for the NC unit, the contents are as follows depending on the condition:

NC

| Item                        | Details                                                                       |                  |
|-----------------------------|-------------------------------------------------------------------------------|------------------|
| Battery vol state           | This displays the current state of the battery voltage as 0 or 1.             |                  |
|                             | Condition                                                                     | Class            |
|                             | 0 (normal state)                                                              | -                |
|                             | 1 (encoder error)<br>(no battery)                                             | Warning (yellow) |
| Battery used years          | This displays approximate time of the battery used from the last replacement. |                  |
|                             | Condition                                                                     | Class            |
|                             | Recommended battery use (5 years) <= Time for the battery used                | Warning (yellow) |
| NC : Temp. 1 (°C)           | This displays the current temperature of the control unit.                    |                  |
|                             | Condition (M800S: Main card/M80/E80)                                          | Class            |
|                             | 78.5°C < Control unit temp. <= 81°C                                           | Caution (gray)   |
|                             | 81°C < Control unit temp.                                                     | Warning (yellow) |
|                             | Condition (M800W: Main card)                                                  | Class            |
|                             | 79°C < Control unit temp. <= 84.5°C                                           | Caution (gray)   |
|                             | 84.5°C < Control unit temp.                                                   | Warning (yellow) |
|                             | Condition (M80W: Main card)                                                   | Class            |
|                             | 79°C < Control unit temp. <= 81.5°C                                           | Caution (gray)   |
| 81.5°C < Control unit temp. | Warning (yellow)                                                              |                  |
| Fan rev (r/min)             | This displays the current fan rotation speed of the control unit.             |                  |
|                             | Condition                                                                     | Class            |
|                             | Fan rot. speed <= 4000 r/min                                                  | Warning (yellow) |

Communication between NC unit and display unit

| Item                  | Details                                                                                                                                                             |
|-----------------------|---------------------------------------------------------------------------------------------------------------------------------------------------------------------|
| Servo comm err Num1   | This displays the count of occurrence for "Y51 SV commu er: Recv frame No. xx04" after the power ON.                                                                |
| Servo comm err Acc1   | This displays the cumulated count of occurrence for " Y51 SV commu er: Recv frame xx04".<br>Press the menu [Servo clear] to clear the cumulated count to "0".       |
| Servo comm err Num2   | This displays the count of occurrence for "Y51 SV commu er: Data ID error xx03" after the power ON.                                                                 |
| Servo comm err Acc2   | This displays the cumulated count of occurrence for "Y51 SV commu er: Data ID error xx03".<br>Press the menu [Servo clear] to clear the cumulated count to "0".     |
| RIO channel/station1  | This displays the Channel No./Station No. of occurrence for continuous error after the power ON.                                                                    |
| RIO retry count max 1 | This displays the maximum value of the continuous error after the power ON.                                                                                         |
| RIO channel/station 2 | This displays the Channel No./Station No. held even if the power OFF.<br>Press the menu [RIO clear] to clear the Channel No./Station No. to "0/0".                  |
| RIO retry count max 2 | This displays the count held even if the power OFF.<br>Press the menu [RIO clear] to clear the count to "0".                                                        |
| Ether comm err Num    | This displays the number of Ethernet communication error after PLC program is executed once.                                                                        |
| Ether comm err Acc    | This displays the cumulated count of occurrence for Ethernet communication error.<br>Press the menu [Ether clear] to clear the cumulated count to "0".              |
| Overvoltage Acc       | This displays the cumulated count of detection frequency of overvoltage after the power ON.<br>Press the menu [Cl. ov.history] to clear the cumulated count to "0". |
| Power losses Num      | This displays the count of detection frequency of instantaneous power interruption after the power ON.                                                              |

| Item             | Details                                                                                                                                                                                 |
|------------------|-----------------------------------------------------------------------------------------------------------------------------------------------------------------------------------------|
| Power losses Acc | This displays the cumulated count of detection frequency of instantaneous power interruption after the power ON.<br>Press the menu [Clear pw loss] to clear the cumulated count to "0". |

(\*2) The following state can be confirmed.



| State         | Details                                                                                                                                                                                                                                                                                                                                                                                                                                                                                                                                                                                                                                                        |
|---------------|----------------------------------------------------------------------------------------------------------------------------------------------------------------------------------------------------------------------------------------------------------------------------------------------------------------------------------------------------------------------------------------------------------------------------------------------------------------------------------------------------------------------------------------------------------------------------------------------------------------------------------------------------------------|
| In-position   | This displays "1" (in-position state) when the following conditions are satisfied for even one axis.<br><ul style="list-style-type: none"> <li>♦There is a control axis whose acceleration/deceleration is not zero.</li> <li>♦There is a control axis whose servo error exceeds the range designated with the parameter.</li> </ul>                                                                                                                                                                                                                                                                                                                           |
| Interlock (+) | When the auto interlock +n-th axis signal or the manual interlock +n-th axis signal is OFF, "1" appears for the n-th axis.<br>(Explanation of the display)<br><div style="text-align: center;">                         o o o o o 1 o<br/>                         ↑                    ↑<br/>                         8th axis    ...    1st axis                     </div><br>In the above case, the 2nd axis is interlocked. Even when the number of usable axes is less than 8 in 1 part system, this displays 8 axes fixed.                                                                                                                              |
| Interlock (-) | When the auto interlock -n-th axis signal or the manual interlock -n-th axis signal is OFF, "1" appears for the n-th axis.<br>The explanation of the display is same as for the "Interlock (+)".                                                                                                                                                                                                                                                                                                                                                                                                                                                               |
| ExtDcc (+)    | When the control axis is moving in (+) direction, "1" appears for the axis if the external deceleration speed is valid, and the feedrate is clamped, exceeding the set value of the external deceleration speed.<br>(Explanation of the display)<br><div style="text-align: center;">                         o o o o o 1 o 1<br/>                         ↑                    ↑<br/>                         8th axis    ...    1st axis                     </div><br>In the above case, the 1st axis and the 3rd axis are in external deceleration speed. Even when the number of usable axes is less than 8 in 1 part system, this displays 8 axes fixed. |
| ExtDcc (-)    | When the control axis is moving in (-) direction, "1" appears for the axis if the external deceleration speed is valid, and the feedrate is clamped, exceeding the set value of the external deceleration speed.<br>The explanation of the display is same as for the "ExtDcc(+)".                                                                                                                                                                                                                                                                                                                                                                             |

**Menus**

| Menus           | Details                                                                                        |
|-----------------|------------------------------------------------------------------------------------------------|
| Servo clear     | This clears the cumulated count of the servo communication error 1 and 2 to "0".               |
| RIO clear       | This clears the cumulated count of the RIO communication error to "0".                         |
| Ether clear     | This clears the cumulated count of the Ether communication error to "0".                       |
| Battery clear   | This clears the time the battery has been used to "0".                                         |
| Clear pw loss   | This clears the accumulated number of instantaneous power interruption detection times to "0". |
| Cl. ov. history | This clears the cumulated count of overvoltage to "0".                                         |

**Clearing the cumulated counter to zero**

(Example) Clearing the cumulated count of the servo communication error

- (1) Press the menu [Servo clear].  An operation message appears.
  
- (2) Press the [Y] or [INPUT] key.  The cumulated count of the servo communication error 1 and 2 will be cleared to "0".  
When other keys are pressed, it will not clear to "0".

This also applies to menus [RIO clear], [Ether clear], [Battery clear], [Clear pw loss] and [Cl. ov.history].

**Display of time limit warning and alarm**

When the expiration date approaches, the warning message "Z64 Valid term soon to be expired" appears at the bottom right of the screen. This warning message appears at every cycle start after the NC power ON until the expiration date comes.

When the expiration date has passed, the alarm message "Z65 Valid term has been expired" appears and cycle start cannot be performed. To cancel this alarm, enter the decryption code issued by MTB, and then turn OFF and ON the NC power.

Even when the expiration date has passed during the automatic operation, the NC continues to operate. However, after the NC once stops by cycle stop, single block stop or inputting a NC reset signal, cycle start cannot be performed.

For the display position of warning and alarm messages, refer to "2.3 Standard Screen".

While the warning is occurring, you can check the number of days remaining before the expiry date.

Open [Diagn] - [Alarm message] - [NC message] screen, then you can check the number of days. The remaining days will be "0" when the date reaches the expiration date.

If you open the [Alarm] screen while the alarm is occurring, "Valid term has been expired" appears. If you attempt a cycle start operation, the stop code "T01 Cycle st. prohibit (Term exp'd)" results, which disables cycle start operation.

**Renewing time limit**

For updating the time limit, users need to ask the MTB to issue a decryption code. The time limit is either updated or canceled when the decryption code is entered.

Decryption code is issued by MTB as decryption code file.

**[How to enter decryption code]**

- (1) Save the decryption code file on an SD card (or USB memory).
- (2) Insert the SD card into the control unit.
- (3) Open the [Mainte] screen and select [Input/Output].
- (4) In the [A:Dev] field, specify a memory card (or USB memory) in [Dev], a directory where the decryption code is stored in [Dir], and the created decryption code file name in [File].
- (5) Select "Memory" in [B:Dev] and press [Dir]. Then the menu key [Decrypt code] appears on the screen. Then the menu key [Decrypt code] appears on the screen. When [Decrypt code] is pressed, "Decryption Code" automatically appears in [Dir] and "PASSCODE.DATA" in [File].  
If you enter "/RLS" in [Dir], the screen will be displayed in the same way.
- (6) Press [Trnsfr A→B].
- (7) When a confirmation message appears, press either [Y] or [INPUT].  
If the decryption code has successfully been set, "Setting complete normally" appears.
  - If the warning message is on the screen, this message will be removed.
  - If the alarm message is on the screen, this message will be removed.
  - If the decryption code is wrong, the message "Can't write file for dev B" will appear. Check the decryption code file and contact the MTB.
  - The "Executing automatic operation" error occurs during program operation, and setting the code is disabled.
- (8) Turn OFF and ON the NC power.

**Precautions for expiry date**

- (1) If you turn OFF and ON the power after the time limit has expired, "EMG Emergency stop LINE" may appear at the same time.
- (2) The warning message "Z64 Valid term soon to be expired" can be erased with NC reset. Contact the MTB for details.

11.3.2 Servo Diagnosis Screen



You can confirm the following information on the servo diagnosis screen by pressing [MaInte] -> [Servo diagn] on the diagnosis (Diagn) screen:

- The number of alarms of servo/spindle drive unit
- DA output information
- PLG diagnosis (spindle)
- The maintenance diagnosis information of servo/spindle unit such as alarm cause counter

This operation is protected according to the operation level.

■ Servo unit

| M001  |                 | SYS1                                                                                                                                                        | MEMORY       | Monitr    | Setup       | Edit          | Diagn       | MaInte    |
|-------|-----------------|-------------------------------------------------------------------------------------------------------------------------------------------------------------|--------------|-----------|-------------|---------------|-------------|-----------|
|       |                 |                                                                                                                                                             | X            | Y         | Z           | C1            |             |           |
| (1) { | Alarm times     | 31                                                                                                                                                          |              |           |             |               |             |           |
|       | Alarm times     | 32                                                                                                                                                          |              |           |             |               |             |           |
| (2) { | 34 AL cause cnt | accu                                                                                                                                                        | 0            | 0         | 0           | 0             |             |           |
|       |                 | freq                                                                                                                                                        | 0            | 0         | 0           | 0             |             |           |
|       | 36 AL cause cnt | accu                                                                                                                                                        | 0            | 0         | 0           | 0             |             |           |
|       |                 | freq                                                                                                                                                        | 0            | 0         | 0           | 0             |             |           |
| (3) { | 38 AL cause cnt | accu                                                                                                                                                        | 0            | 0         | 0           | 0             |             |           |
|       |                 | freq                                                                                                                                                        | 0            | 0         | 0           | 0             |             |           |
|       | 39 AL cause cnt | accu                                                                                                                                                        | 0            | 0         | 0           | 0             |             |           |
|       |                 | freq                                                                                                                                                        | 0            | 0         | 0           | 0             |             |           |
|       |                 | DA Address                                                                                                                                                  | 1            |           |             |               |             |           |
|       |                 | DA output                                                                                                                                                   | 1            |           |             |               |             |           |
|       |                 | DA Address                                                                                                                                                  | 2            |           |             |               |             |           |
|       |                 | DA output                                                                                                                                                   | 2            |           |             |               |             |           |
|       |                 | <div style="display: flex; justify-content: space-between; align-items: center;"> <span>↑ 1RDY 2RDY</span> <span>S/W 18:48</span> <span>Key →</span> </div> |              |           |             |               |             |           |
|       |                 | Mainte                                                                                                                                                      | Param        | I/O       |             |               |             |           |
|       |                 | Servo unit                                                                                                                                                  | Spindle unit | PLG diagn | All num clr | Alarm num clr | All cnt clr | Next axis |

■ Spindle unit

(1) Display of the DA output data

| M001  |                 | SYS1                                                                                                                                                        | MEMORY       | Monitr    | Setup       | Edit          | Diagn       | MaInte    |
|-------|-----------------|-------------------------------------------------------------------------------------------------------------------------------------------------------------|--------------|-----------|-------------|---------------|-------------|-----------|
|       |                 |                                                                                                                                                             | S1           | S2        | S3          | S4            |             |           |
| (1) { | Alarm times     | 31                                                                                                                                                          |              |           |             |               |             |           |
|       | Alarm times     | 32                                                                                                                                                          |              |           |             |               |             |           |
| (2) { | 34 AL cause cnt | accu                                                                                                                                                        | 0            | 0         | 0           | 0             |             |           |
|       |                 | freq                                                                                                                                                        | 0            | 0         | 0           | 0             |             |           |
|       | 36 AL cause cnt | accu                                                                                                                                                        | 0            | 0         | 0           | 0             |             |           |
|       |                 | freq                                                                                                                                                        | 0            | 0         | 0           | 0             |             |           |
| (3) { | 38 AL cause cnt | accu                                                                                                                                                        | 0            | 0         | 0           | 0             |             |           |
|       |                 | freq                                                                                                                                                        | 0            | 0         | 0           | 0             |             |           |
|       | 39 AL cause cnt | accu                                                                                                                                                        | 0            | 0         | 0           | 0             |             |           |
|       |                 | freq                                                                                                                                                        | 0            | 0         | 0           | 0             |             |           |
|       |                 | DA Address                                                                                                                                                  | 1            |           |             |               |             |           |
|       |                 | DA output                                                                                                                                                   | 1            |           |             |               |             |           |
|       |                 | DA Address                                                                                                                                                  | 2            |           |             |               |             |           |
|       |                 | DA output                                                                                                                                                   | 2            |           |             |               |             |           |
|       |                 | <div style="display: flex; justify-content: space-between; align-items: center;"> <span>↑ 1RDY 2RDY</span> <span>S/W 18:49</span> <span>Key →</span> </div> |              |           |             |               |             |           |
|       |                 | Mainte                                                                                                                                                      | Param        | I/O       |             |               |             |           |
|       |                 | Servo unit                                                                                                                                                  | Spindle unit | PLG diagn | All num clr | Alarm num clr | All cnt clr | Next axis |



(2) Display of the spindle PLG diagnosis information

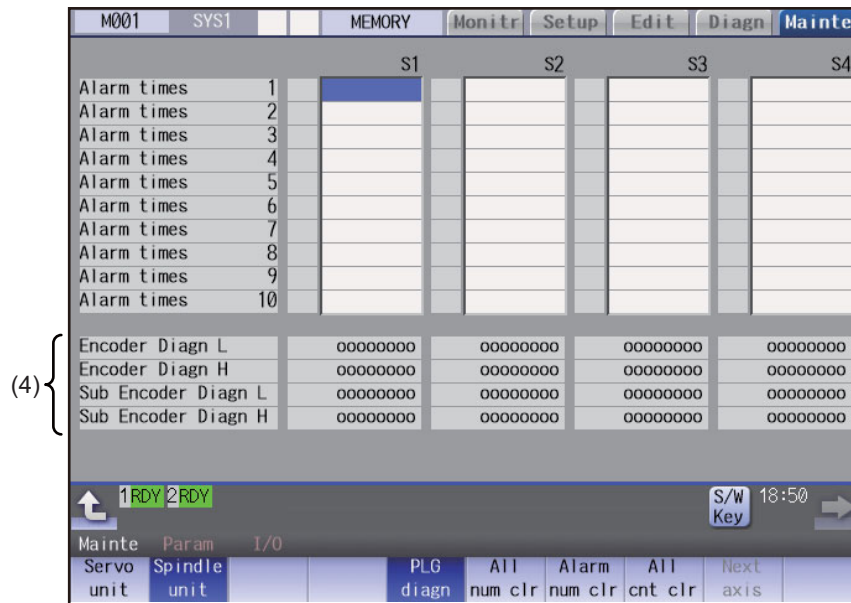

Display items

| Display items                                                   | Details                                                                                                                                                                                                                                                                                                                                                                                                                                                                                                                       |
|-----------------------------------------------------------------|-------------------------------------------------------------------------------------------------------------------------------------------------------------------------------------------------------------------------------------------------------------------------------------------------------------------------------------------------------------------------------------------------------------------------------------------------------------------------------------------------------------------------------|
| (1) Alarm times                                                 | <p>This displays the data for each axis or unit.<br/>There are Alarm times 1 to 32, and there are switched with the page up/down keys.<br/>The number of times can be cleared for each axis or each column.</p> <p>Alarm No: Servo alarm No. (unit: ASCII)<br/>No. of times: The number of times of meeting the servo alarm condition after the servo drive unit ON. (Units: Number of times)</p>                                                                                                                             |
| (2) Alarm cause counter                                         | <p>An alarm occurs when the specified number of conditions are met. This counter displays the number of times in which the alarm occurrence condition is met since the drive unit power was turned ON.<br/>The number of times can be cleared for each axis with [All cnt clr].</p> <p>accu: Displays the number of times in which the alarm occurrence condition was met since the drive unit power was turned ON.<br/>freq: Displays the peak hold value when the alarm occurrence condition is met per constant cycle.</p> |
| (3) DA output                                                   | <p>This displays the data for each axis or unit.</p> <p>DA Address 1: Servo parameter sv061 set value (address) (unit: ASCII)<br/>DA output 1: Servo parameter sv061 set address data (unit: pulse)<br/>DA Address 2: Servo parameter sv062 set value (address) (unit: ASCII)<br/>DA output 2: Servo parameter sv062 set address data (unit: pulse)</p>                                                                                                                                                                       |
| (4) Spindle PLG diagnosis information (Spindle drive unit only) | <p>Displays the data for each axis</p> <p>Encoder Diagn L: Displays the output signal (Low) of the motor end PLG<br/>Encoder Diagn H: Displays the output signal (High) of the motor end PLG<br/>Sub Encoder Diagn L: Displays the output signal (Low) of the machine end PLG<br/>Sub Encoder Diagn H: Displays the output signal (High) of the machine end PLG</p>                                                                                                                                                           |

Note

(1) PLG (pulse generator) detects the pulse signal and it is used to detect the rotation state of the motor.

## Menus

| Menus         | Details                                                                                                                                                                                                                                                                                                                                                                                                                                                         |
|---------------|-----------------------------------------------------------------------------------------------------------------------------------------------------------------------------------------------------------------------------------------------------------------------------------------------------------------------------------------------------------------------------------------------------------------------------------------------------------------|
| Servo unit    | Displays the servo unit diagnosis information in the data display area.                                                                                                                                                                                                                                                                                                                                                                                         |
| Spindle unit  | Displays the spindle unit diagnosis information in the data display area.<br><Note><br>•When the parameter "#1039 spinno" is set to "0", this menu is not displayed.                                                                                                                                                                                                                                                                                            |
| PLG diagn     | Switches the display between the DA output and the spindle PLG diagnosis information. Pressing this button again after this menu is highlighted, the display switches to the DA output.<br><Note><br>•When the parameter "#1039 spinno" is set to "0", this menu is not displayed.<br>•Even when the parameter "#1039 spinno" is set to other than "0", this menu will be grayed out and non-selectable. while displaying the servo unit diagnosis information. |
| All num clr   | This clears the number of alarms of the axis at the cursor position to "0".                                                                                                                                                                                                                                                                                                                                                                                     |
| Alarm num clr | This clears the number of alarms at the cursor position to "0".<br><Note><br>•When the cursor is on "AL cause cnt accu" or "freq", this menu is grayed out and non-selectable.                                                                                                                                                                                                                                                                                  |
| All cnt clr   | Clears the all values of "AL cause cnt accu" and "freq" of the axis where the cursor is placed to 0.                                                                                                                                                                                                                                                                                                                                                            |
| Next axis     | Displays the data of four axes from the next axis.<br>This menu is displayed only when there are five or more servo axes or spindle.                                                                                                                                                                                                                                                                                                                            |

11.3.3 Collecting the Data on the Diagnosis Data Collection Setting Screen



The NC automatically collects diagnosis data based on the "Sampling spec" and "Collecting data select" settings specified on the diagnosis data collection (Collect set) screen of the maintenance (Mainte) screen. This operation is protected according to the operation level.

**Note**

(1) Make sure to use this function under our instructions. It may cause misoperation if you use the function based on your own judgments.

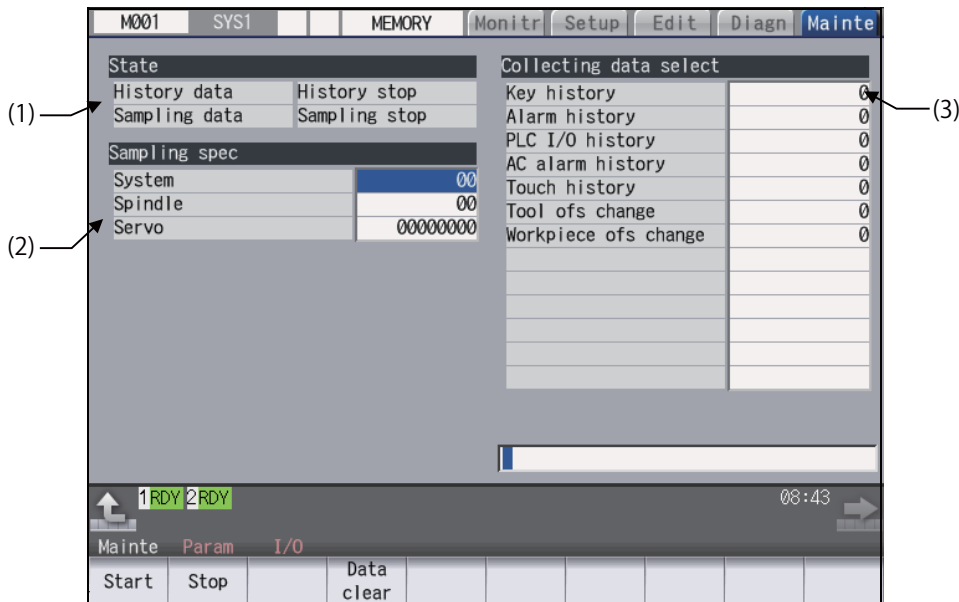



**Display items**

| Display items | Details                                                                                                                                                                                                              |
|---------------|----------------------------------------------------------------------------------------------------------------------------------------------------------------------------------------------------------------------|
| (1) State     | Display the history data and sampling data collection status.                                                                                                                                                        |
| History data  | Display the history data collection status.<br>History collecting: History data collection is in progress.<br>History stop: History data collection is stopped.                                                      |
| Sampling data | Display the sampling data collection status.<br>Sampling: Sampling data collection is in progress.<br>Sampling stop: Sampling data collection is stopped.<br>Sampling invalid: Sampling data collection is disabled. |

| Display items                      | Details                                                                                                                                                                                                                                                                       |
|------------------------------------|-------------------------------------------------------------------------------------------------------------------------------------------------------------------------------------------------------------------------------------------------------------------------------|
| (2) Sampling specifications        | Specify the part system, spindle, and servo axes where sampling data is to be collected.                                                                                                                                                                                      |
| System                             | Specify the part systems where sampling data is not to be collected.<br>Specify the part system in HEX.<br>When "0" is set, sampling is carried out for all part systems.<br>This setting is ignored if a non-existent part system is specified.                              |
| Spindle                            | Specify the spindle where sampling data is not to be collected.<br>Specify the part system in HEX.<br>When "0" is set, sampling is carried out for all spindles.<br>This setting is ignored if a non-existent spindle is specified.                                           |
| Servo                              | Specify the servo axes where sampling data is not to be collected.<br>Specify the part system in HEX.<br>This setting is not system-specific.<br>When "0" is set, sampling is carried out for all axes.<br>This setting is ignored if a non-existent servo axis is specified. |
| (3) Collecting data select         | This selects the diagnosis data to be collected.<br>0: Collected.<br>1: Not collected.                                                                                                                                                                                        |
| Key history                        | This selects whether or not key history data is collected.                                                                                                                                                                                                                    |
| Alarm history                      | This selects whether or not alarm history data is collected.                                                                                                                                                                                                                  |
| PLC I/O history                    | This selects whether or not PLC input/output signal history data is collected.                                                                                                                                                                                                |
| AC alarm history                   | This selects whether or not AC power ON/OFF history data is collected.                                                                                                                                                                                                        |
| Touch history                      | This selects whether or not touchscreen history data is collected.                                                                                                                                                                                                            |
| Tool ofs change                    | This selects whether or not tool offset change history data is collected.                                                                                                                                                                                                     |
| Workpiece ofs change               | This selects whether or not workpiece offset change history data is collected.                                                                                                                                                                                                |
| Alarm detailed information history | This selects whether or not detailed alarm history information when an alarm occurs.<br>Warnings are excluded.                                                                                                                                                                |

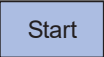
## Menus

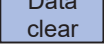
| Menus                                                                               | Details                                                                                                                                              |
|-------------------------------------------------------------------------------------|------------------------------------------------------------------------------------------------------------------------------------------------------|
|  | This begins collecting sampling data and history data.                                                                                               |
|  | This stops the sampling data and history data collection operation.                                                                                  |
|  | This stops the sampling data and history data collection operation, and clears the collected data.<br>This is not displayed when "#1263 bit1" is ON. |

## Note

- (1) The alarm history data collection start/stop operation is switched using the menu [Start] or [Stop] of data collection regardless of whether "Alarm history" is set to "0" or "1".

**Operation method (Start of data collection)**

- (1) Press the menu [Start].
- (2) Press the [Y] or [INPUT] key.

**Note**

- (1) Data collection starts even if "Alarm history" is set to "1" (not collected).

**Operation method (Stop of data collection)**

- (1) Press the menu [Stop].
- (2) Press the [Y] or [INPUT] key.

**Note**

- (1) Data collection stops even if "Alarm history" is set to "1" (not collected).

**Operation method (Clear of collected data)**

- (1) Press the menu [Data clear].
- (2) Press the [Y] or [INPUT] key.

## 11.4 Advanced Diagnosis

Be sure to perform the operations in this section under the MTB instructions.

### 11.4.1 Displaying and Setting the PLC Device Data (I/F Diagnosis Screen)



The various input/output signals for the PLC (Programmable Logic Controller) control can be displayed and set in this screen.

These signals can be used in confirmation of the machine sequence operation during PLC development, and in confirmation and forced output, etc., of the input/output data between the NC and PLC.

#### Note

- (1) Pay close attention to the sequence operation when using these functions during machine operation.



| Display items                                                             |                                                                                                                                                                                                                                                                                                                                                                                                                                                                                                                                                                                                     |
|---------------------------------------------------------------------------|-----------------------------------------------------------------------------------------------------------------------------------------------------------------------------------------------------------------------------------------------------------------------------------------------------------------------------------------------------------------------------------------------------------------------------------------------------------------------------------------------------------------------------------------------------------------------------------------------------|
| Display items                                                             | Details                                                                                                                                                                                                                                                                                                                                                                                                                                                                                                                                                                                             |
| (1) Project                                                               | This displays the currently displayed project.                                                                                                                                                                                                                                                                                                                                                                                                                                                                                                                                                      |
| (2) Device No. and input/output signal value (binary/hexadecimal display) | This displays the data from the device Nos. designated in the setting area in numerical order.<br>The data is displayed as binary (bit units) and hexadecimal values.<br>Individual device Nos. can be displayed separately in the left area and right area. Select the display area with the $\leftarrow$ and $\rightarrow$ key when operations such as display changeover and data setting are carried out.<br>Target device:<br>X, Y, M, L, F, SB, B, SM, V, SW, SD, TI, TO, TS, TA, STI, STO, STS, STA, CI, CO, CS, CA, D, R, ZR, W<br>The common devices for each project are X, Y, R, and ZR. |
| (3) Modal output                                                          | This displays the data and device to carry out modal output.<br>The details to be defined are set here when carrying out the modal type forced output of PLC interface signals.<br>For details, refer to "Carrying Out Modal Output".                                                                                                                                                                                                                                                                                                                                                               |

| Display items     | Details                                                                                                                                                                                                                                        |
|-------------------|------------------------------------------------------------------------------------------------------------------------------------------------------------------------------------------------------------------------------------------------|
| (4) 1-shot output | This displays the data and device to carry out one-shot output.<br>The details to be defined are set here when carrying out the one-shot type forced output of PLC interface signals.<br>For details, refer to "Carrying Out One-shot Output". |

**Menus**

| Menus         | Details                                                                                                                                         |
|---------------|-------------------------------------------------------------------------------------------------------------------------------------------------|
| Modal output  | This changes the setting area to an input standby status. The signal is forcibly output (modal).                                                |
| 1-shot output | This changes the setting area to an input standby status. The signal is forcibly output (one-shot).                                             |
| Modal all clr | A confirmation message appears, and the machine turns into standby status. The force OP (one-shot output) of all I/O signals are canceled. (*1) |
| Next Project  | The device and I/O signal of the next project are displayed. If the last project is displayed, the top project is displayed.                    |

(\*1) These menus are grayed out ordinarily, and cannot be operated.

**How to read the device No. and display data**

A device is an address for classifying a signal handled in the PLC. A device No. is a series of numbers attached to that device.

Device No. (bit-type)

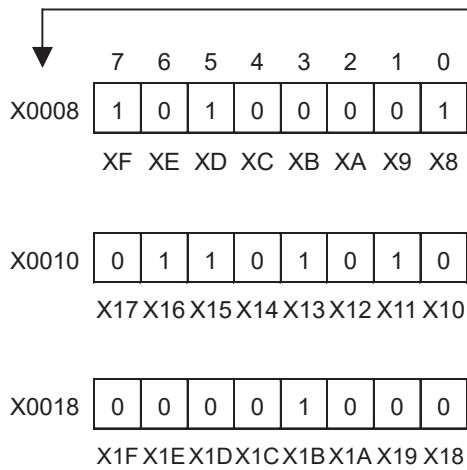

| DEV   | 76543210 | HEX | DEV   | 76543210 | HEX |
|-------|----------|-----|-------|----------|-----|
| X0000 | 00000000 | 00  | Y0000 | 00000000 | 00  |
| X0008 | 10100001 | A1  | Y0008 | 00000000 | 00  |
| X0010 | 01101010 | 6A  | Y0010 | 10100000 | A0  |
| X0018 | 00001000 | 08  | Y0018 | 00000001 | 01  |
| X0020 | 01111100 | 7C  | Y0020 | 00000000 | 00  |
| X0028 | 00001111 | 0F  | Y0028 | 00000000 | 00  |
| X0030 | 00000010 | 02  | Y0030 | 00000000 | 00  |

Signal status display corresponding to each device No. (I/O)

Device No. (word-type)

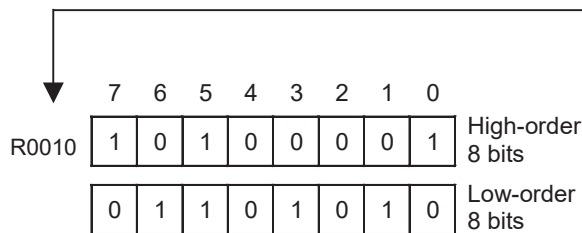

| DEV    | 76543210 | HEX |
|--------|----------|-----|
| R00010 | 10100001 | A1  |
|        | 01101010 | 6A  |
| R00011 | 00001001 | 09  |
|        | 00000101 | 05  |
| R00012 | 00010010 | 12  |
|        | 00000110 | 06  |
| R00013 | 00001010 | 0A  |
|        | 00010101 | 15  |

### 11.4.1.1 Displaying the PLC Device Data

The various status signals and register data used in the PLC can be monitored and displayed.

When this screen is first selected, the respective 16-byte amounts of input/output data are displayed from device "X0000" on the left display area, and from device "Y0000" on the right side.

This screen constantly monitors and displays the PLC signal statuses. Consequently, when signals are changed in the PLC, the display is changed according to the changes.

Note that because time differences occur between the PLC signal change and the signal display, there may be a delay in the display. The machine may also not be able to correspond to extremely brief signal changes.

#### Displaying the data of a arbitrary device No. "X0020"

- (1) Press the menu [Next Project].



The display is switched to the I/O signal of the next project. (Press the menu key to switch the project in order. Note that only projects are switched, but the device number currently displayed is not switched.)

|         |              |
|---------|--------------|
| Project | 6            |
| DEV     | 76543210 HEX |
| X0008   | 00000000 00  |
| X0010   | 00000000 00  |

The device number in the top is not switched.

- (2) Press the menu tab key / , and select the area to display the data.

- (3) Set the device No. (X0020), and press the [INPUT] key.



The device "X0020" appears at the head of the valid display area.

| DEV   | 76543210 | HEX | DEV   | 76543210 | HEX |
|-------|----------|-----|-------|----------|-----|
| X0020 | 11111111 | FF  | Y0000 | 00000000 | 00  |
| X0028 | 01000000 | 40  | Y0008 | 00000001 | 01  |
| X0030 | 00001110 | 0E  | Y0010 | 00000000 | 00  |
| X0038 | 00000000 | 00  | Y0018 | 00000000 | 00  |

#### Note

- (1) When setting the device No., an error will occur if a number exceeding the specifications or an illegal address is set.
- (2) The input/output signals of X, Y, R, and ZR are the same for all projects.

#### Changing the display with the page keys

The valid area device Nos. change in page units when / is pressed. Changing of the pages stops within the range of device numbers of which the device has.

- (1) Press the key.



The data is displayed from the next number currently displayed.

| DEV   | 76543210 | HEX | DEV   | 76543210 | HEX |
|-------|----------|-----|-------|----------|-----|
| X0000 | 10000001 | 81  | Y0000 | 00000000 | 00  |
| X0008 | 00000010 | 02  | Y0008 | 00000001 | 01  |
| X0010 | 00001111 | 0F  | Y0010 | 00000000 | 00  |
| X0018 | 10011111 | 9F  | Y0018 | 00000000 | 00  |



| DEV   | 76543210 | HEX | DEV   | 76543210 | HEX |
|-------|----------|-----|-------|----------|-----|
| X0080 | 11111111 | FF  | Y0000 | 00000000 | 00  |
| X0088 | 01000000 | 40  | Y0008 | 00000001 | 01  |
| X0090 | 00001111 | 0F  | Y0010 | 00000000 | 00  |
| X0098 | 00000000 | 00  | Y0018 | 00000000 | 00  |







### 11.4.1.2 Carrying Out Modal Output

Modal type forced output of PLC interface signals is carried out. Once set, this data is held until cancelled, the power is turned ON/OFF, or other data is overwritten. There are four sets of devices that modally output. If this number is exceeded, the previously existing data is overwritten.

#### Menus used in modal output

| Menus       | Details                                                                                                                                    |
|-------------|--------------------------------------------------------------------------------------------------------------------------------------------|
| Modal clear | This releases the modal output for the device at the cursor position in the modal output area. The released data is erased from this area. |





#### Modally outputting data "1" to device "X0048"

- (1) Press the menu [Modal output].  The mode changes to the modal output mode, and the cursor appears at the modal output area.
- (2) Using the [↑] and [↓] keys, move the cursor to the setting position.
- (3) Set the device and data, and press the [INPUT] key.  Modal output is executed, and the cursor disappears. The data that was in the cursor position is overwritten by the input data, and is invalidated. The modal output mode is canceled by pressing the  key or the  key.

#### Note

- (1) The data of the modally output device is displayed in order in the selected area. This modal output is held until the output is canceled or the power is turned OFF.
- (2) When no data is set (Example: "X0048/", "X0048"), the operation message "Setting Data not found" is displayed.
- (3) The X, Y, R, and ZR devices are modally output for all projects.
- (4) The devices other than X, Y, R, and ZR are modally output for the currently displayed project.

#### Releasing the modal output

- (1) Press the menu [Modal output].  The mode changes to the modal output mode, and the cursor appears at the modal output area.
- (2) Using the [↑] and [↓] keys, move the cursor to the data to be released.
- (3) Press the menu [Modal clear].  The data that was in the cursor position is released from modal output. The "DEV" and "Data" columns become blank. The modal output mode is canceled by pressing the  key or the  key.

#### CAUTION

Pay close attention to the sequence operation when carrying out forced data setting (forced output) in the I/F diagnosis screen during machine operation.

## 11.4.1.3 Carrying Out One-shot Output

The one-shot type PLC interface signal forced output is forcibly output only once during the screen operations. Thus, it may not be possible to confirm the PLC interface signals updated with the PLC on the screen.

**One-shot outputting data "1" to device "X0042"**

- (1) Press the menu [Next Project].



The display is switched to the I/O signal of the next project.  
(Press the menu key to switch the project in order.)

|         |          |     |
|---------|----------|-----|
| Project | 6        |     |
| DEV     | 76543210 | HEX |
| X0008   | 00000000 | 00  |
| X0010   | 00000000 | 00  |

- (2) Press the menu [1-shot output].

- (3) Set the device and data, and press the [INPUT] key.  
X0042/1 [INPUT]



The input data is overwritten in the one-shot output area, and is one-shot output.  
The cursor in the one-shot output area disappears.  
The data of the one-shot output device is displayed in order in the selected area.  
The one-shot output mode is canceled by pressing the key or the key.

**Note**

- (1) Because the input signal (X, etc.) to the PLC is updated at the head of each PLC cycle, the machine immediately returns to the normal state, even if one-shot type forced output is carried out.
- (2) When no data is set (Example: "X0048/", "X0048"), the operation message "Setting Data not found" is displayed.
- (3) The X, Y, R, and ZR devices are one-shot output for all projects.
- (4) The devices other than X, Y, R, and ZR are one-shot output for the currently displayed project.

**CAUTION**

Pay close attention to the sequence operation when carrying out forced data setting (forced output) in the I/F diagnosis screen during machine operation.

11.4.2 Writing and Reading the Data Using the NC Data Designation (NC Memory Diagnosis Screen)



The NC internal data can be displayed and rewritten on the NC memory diagnosis (Mem dia) screen of the diagnosis (Diagn) screen. The custom API library's NC data read/write interface is used to display and rewrite the NC's internal data. The contents of the NC data can be displayed by designating the part system No., section No., sub-section No. and axis No. on this screen.

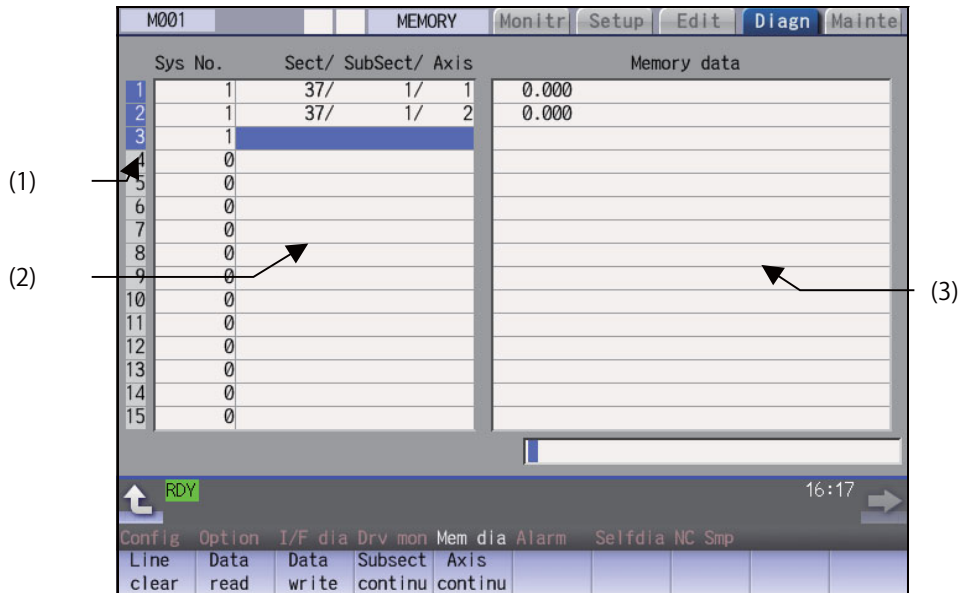

Display items

| Display items     | Details                                                                                                                                                                                                                                                                                                                                                                                                                                                              |
|-------------------|----------------------------------------------------------------------------------------------------------------------------------------------------------------------------------------------------------------------------------------------------------------------------------------------------------------------------------------------------------------------------------------------------------------------------------------------------------------------|
| (1) Index No.     | This displays the registration No. of the NC memory data. When one of the "2. Data contents" is set, the number is highlighted indicating that the normal display of the data contents has stopped.                                                                                                                                                                                                                                                                  |
| (2) Data contents | Part system No.<br>Designate the part system No. (1: 1st part system). Designate "0" to designate the data common for the part systems.<br>Section/sub-section/axis:<br>Designate the section No., sub-section No. and axis No. of the data to be set and displayed. The setting format is, section No./sub-section No./axis No.<br><Note><br>♦The axis No. "1" is handled as the first axis. Designate "0" for the data which does not require an axis designation. |
| (3) Memory data   | This displays the contents of the data.                                                                                                                                                                                                                                                                                                                                                                                                                              |

## Menus

| Menus           | Details                                                                                                                                                                                                                                                                                          |
|-----------------|--------------------------------------------------------------------------------------------------------------------------------------------------------------------------------------------------------------------------------------------------------------------------------------------------|
| Line clear      | This erases the information in the line where the cursor is. (One entire line becomes blank.) The cursor does not move at this time.                                                                                                                                                             |
| Data read       | The contents of the set address data (Part system No, Section/sub-section/axis) for all the lines are constantly displayed.<br>The Index No. highlight (indicating data is being set) is released.<br>The cursor appears in "Part system No" of that line.                                       |
| Data write      | This writes the data in the setting area to the NC memory indicated by address data at the cursor position. (*1)<br>The Data No. highlight (indicating data is being set) is released, and constant display is started.<br>After writing, the cursor moves to "Part system No" of the next line. |
| Subsect continu | Based on the data of the address data where the cursor is, this displays the continuous data to which the sub-section No. has been added to the address data from the line where the cursor is.<br>The cursor moves to "Part system No " of that line.                                           |
| Axis continu    | Based on the data of the address data where the cursor is, this displays the continuous data to which the axis No. has been added to the address data from the line where the cursor is.<br>The cursor moves to "Part system No " of that line.                                                  |

(\*1) Decimal, hexadecimal, floating point data and character string data writing is possible. Note that hexadecimal, floating point data and character strings may not be settable depending on the data.

Decimal: Integers without decimal points (Example) -1234

Hexadecimal: An "H" is necessary at the end (Example) 1234H

Floating point data: Data with a decimal point (Example) -12.3

Character string data: Character string (Example) X

## 11.4.3 Collecting the NC Data (Data Sampling Screen)



Sampling start/stop, sampling state display, setting the sampling parameters necessary for sampling are performed in the data sampling screen. The NC internal data (speed output from NC to the drive unit, or feedback data from the drive unit, etc.) can be sampled.

Also, the sampling data can be output externally on the I/O screen on the maintenance (Mainte) screen.

Sampling specifications

|                              |                                                                                      |
|------------------------------|--------------------------------------------------------------------------------------|
| Sampling cycle               | 1.776 ms x Setting value                                                             |
| Number of sampled axes       | NC axis: Maximum number of usable axes<br>Spindle: Maximum number of usable spindles |
| Number of sampled channels   | 1 to 16 points                                                                       |
| Number of sampled data items | Max. 2,620,416 points (M800W/M800S)<br>Max. 655,360 points (M80W/M80/E80)            |

### Note

- (1) The maximum number of sampled data items is the total number of data. When the number of sampled channels is increased, the number of data per channel will decrease.

## 11.5 Safety Observation



The configuration, signal status, drive status and version in use of the smart safety observation function are displayed on the safety observation screen.

### 11.5.1 Safety Observation Screen (Configuration Diagnosis)

The available/unavailable states of the smart safety observation function are displayed on the configuration diagnosis screen.

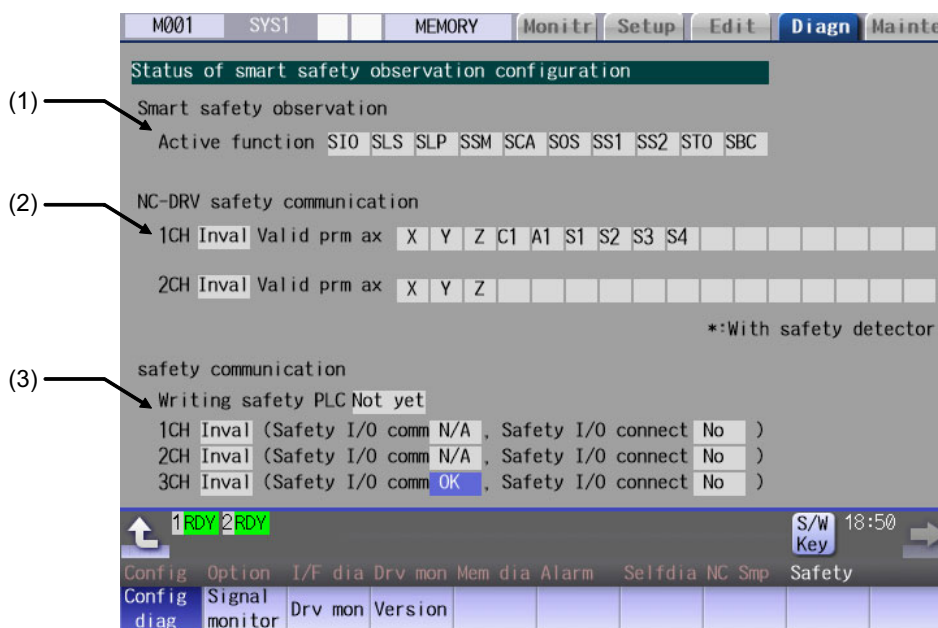

#### Display items

| Display items                   | Details                                                                                                                                                                                                                                                                                                                                                                                                                                                                                                                                                                           |
|---------------------------------|-----------------------------------------------------------------------------------------------------------------------------------------------------------------------------------------------------------------------------------------------------------------------------------------------------------------------------------------------------------------------------------------------------------------------------------------------------------------------------------------------------------------------------------------------------------------------------------|
| (1) Active function             | The drive safety functions which are enabled with the parameters are highlighted.<br>SIO: Safety-related I/O observation, emergency stop observation<br>SLS: Safety-limited speed observation<br>SLP: Safety-limited position observation<br>SSM: Safe speed monitor<br>SCA: Safe cam<br>SOS: Safe operating stop observation<br>SS1: Safe stop 1<br>SS2: Safe stop 2<br>STO: Safe torque OFF<br>SBC: Safe brake control                                                                                                                                                          |
| (2) NC-DRV safety communication | This displays the safety communication status of the drive unit.<br>To perform the safety drive communication, the smart safety observation target axis needs to be set by the parameter, and the connected channel with the drive unit needs to be optical communication and configured only with drive units MDS-E Series.<br>Valid prm ax:<br>Out of the axes connected to each channel, the axes that the parameter "#51101 SF_Disable" (Disable smart safety observation) is OFF are highlighted. For the axis with safety encoder, "*" appears at the top of the axis name. |

| Display items                   | Details                                                                                                                                                                                                                                                                                                                                                                                                                                                                                                                                                                                                                                                                                     |
|---------------------------------|---------------------------------------------------------------------------------------------------------------------------------------------------------------------------------------------------------------------------------------------------------------------------------------------------------------------------------------------------------------------------------------------------------------------------------------------------------------------------------------------------------------------------------------------------------------------------------------------------------------------------------------------------------------------------------------------|
| (3) NC-I/O safety communication | <p>This displays the communication status of the safety I/O communication. To perform the safety I/O communication, at least one of remote I/O channels needs to be configured with the safety I/O devices (safety remote I/O unit, operation panel equipped with safety I/Os) and RIO2.0 unit alone.</p> <p>Writing safety PLC:<br/>This displays the status (Done/Not yet) whether the PLC ladder for safety is written.</p> <p>Safety I/O comm:<br/>"OK" is displayed when the channel is configured only with RIO2.0 units.</p> <p>Safety I/O connect:<br/>"Yes" is displayed when connected to the safety I/O devices (safety RIO unit, operation panel equipped with safety I/O).</p> |

### Menus

| Menus          | Details                                                                                                                                                                                      |
|----------------|----------------------------------------------------------------------------------------------------------------------------------------------------------------------------------------------|
| Config diag    | This switches the screen to the configuration diagnosis display of the smart safety observation.                                                                                             |
| Signal monitor | This switches the screen to the signal monitor display of the smart safety observation.                                                                                                      |
| Drive monitor  | This switches the screen to the drive monitor display of the smart safety observation.                                                                                                       |
| Version        | This switches the screen to the version display of the smart safety observation.                                                                                                             |
| Servo unit     | This switches the drive monitor diagnosis information to the servo unit information. Only when the drive monitor is displayed, the menu appears, and the operation can be performed.         |
| Spindle unit   | This switches the drive monitor diagnosis information to the spindle unit information. Only when the drive monitor is displayed, the menu appears, and the operation can be performed.       |
| Next axis      | This switches the axis to be displayed on the drive monitor. Only when the number of axes is five or more on the drive monitor screen, the menu appears, and the operation can be performed. |

11.5.2 Safety Observation Screen (Signal Monitor)

The signal monitor screen displays the safety PLC signal status. The safety PLC signal displays both of the duplex PLC signals to identify the incongruous state. With the initial display, the input/output signal status from the device "X0000" is displayed on the left side and the input/output signals from the device "Y0000" is displayed on the right side.

Note that because time differences occur between the PLC signal change and the signal display, there may be a delay in the display. The machine may also not be able to correspond to extremely brief signal changes.

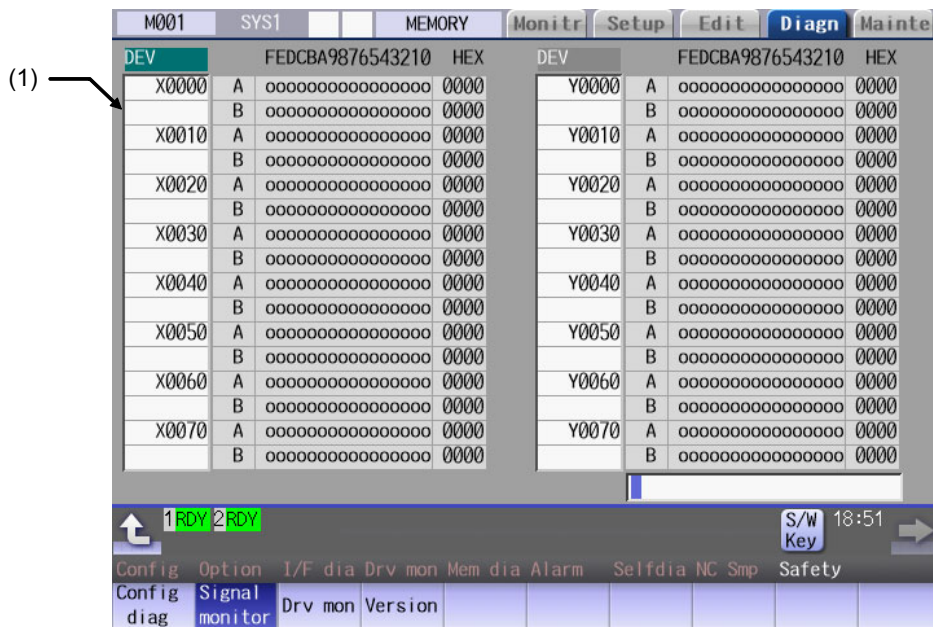

Display items

| Display items                                                             | Details                                                                                                                                                                                                                                                                                                                                                                                                                                                                                                                                                                                                       |
|---------------------------------------------------------------------------|---------------------------------------------------------------------------------------------------------------------------------------------------------------------------------------------------------------------------------------------------------------------------------------------------------------------------------------------------------------------------------------------------------------------------------------------------------------------------------------------------------------------------------------------------------------------------------------------------------------|
| (1) Device No. and input/output signal value (binary/hexadecimal display) | <p>This displays the duplex safety PLC signals (A, B) from the designated device No. in order.</p> <p>The input/output signal is displayed in binary and hexadecimal (bitwise).</p> <p>The device to be displayed can be switched individually for the left area and right area. The operation target (right or left) can be switched with the  and  keys.</p> <p>The head device and the operation target area are held until the power OFF.</p> <p>The displayable devices are X, Y, and ZR.</p> <p>If there is a comparison error with duplex safety PLC signals, the background color becomes yellow.</p> |

List of displayable PLC devices



| Devices | Device No.    | No. of points | Units  | Details                                       |
|---------|---------------|---------------|--------|-----------------------------------------------|
| X       | X0 to X1FF    | 512           | 1-bit  | Input signals to PLC, machine input, etc.     |
| Y       | Y0 to Y1FF    | 512           | 1-bit  | Output signals from PLC, machine output, etc. |
| ZR      | ZR0 to ZR3071 | 3072          | 16-bit | File register, CNC word I/F                   |



**Displaying the PLC device input/output signal**

To refer the arbitrary input/output signal status, enter the target device No. to the input area, and the display will be switched.

(Example) For displaying the input/output signal of the arbitrary device No. "X0020"

- (1) Press the tab key  or  to select the area where the data is displayed.
- (2) Set the device No. (X0020), and then press the [INPUT] key.

**Note**

- (1) Setting a device No. which exceeds the specification or setting an illegal address causes a setting error.

**Changing the display with the page keys**

The operation target device Nos. change in page unit when  /  is pressed. Changing of the pages stops within the range of device numbers of which the device has.

11.5.3 Safety Observation Screen (Drive Monitor)

The safety communication state with servo drive (NC axis, PLC axis) and spindle drive can be monitored. Only the safety drive communication parameter enabled axes are displayed on this screen.

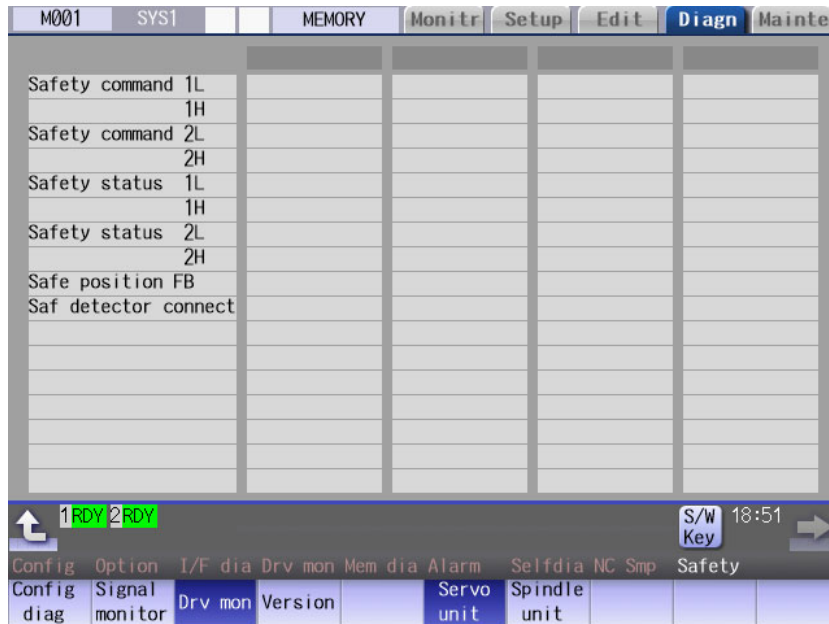

Display items

| Display items     | Details                                                                                                                                                                                                                                                                                                                                                                                                                                                                                                                                                                                                                                                                                                                                                                 |     |                                              |         |    |   |                                              |   |  |   |  |   |  |   |  |   |  |   |  |    |   |  |   |  |   |  |   |  |   |  |   |  |   |  |   |  |   |  |
|-------------------|-------------------------------------------------------------------------------------------------------------------------------------------------------------------------------------------------------------------------------------------------------------------------------------------------------------------------------------------------------------------------------------------------------------------------------------------------------------------------------------------------------------------------------------------------------------------------------------------------------------------------------------------------------------------------------------------------------------------------------------------------------------------------|-----|----------------------------------------------|---------|----|---|----------------------------------------------|---|--|---|--|---|--|---|--|---|--|---|--|----|---|--|---|--|---|--|---|--|---|--|---|--|---|--|---|--|---|--|
| Safety command 1L | This displays the data sent to the drive. <table border="1" style="margin-left: 20px;"> <thead> <tr> <th></th> <th>Bit</th> <th>Details</th> </tr> </thead> <tbody> <tr> <td rowspan="7">1L</td> <td>0</td> <td>STO command (0: No command, 1: With command)</td> </tr> <tr><td>1</td><td></td></tr> <tr><td>2</td><td></td></tr> <tr><td>3</td><td></td></tr> <tr><td>4</td><td></td></tr> <tr><td>5</td><td></td></tr> <tr><td>6</td><td></td></tr> <tr> <td rowspan="9">1H</td> <td>7</td> <td></td> </tr> <tr><td>8</td><td></td></tr> <tr><td>9</td><td></td></tr> <tr><td>A</td><td></td></tr> <tr><td>B</td><td></td></tr> <tr><td>C</td><td></td></tr> <tr><td>D</td><td></td></tr> <tr><td>E</td><td></td></tr> <tr><td>F</td><td></td></tr> </tbody> </table> |     | Bit                                          | Details | 1L | 0 | STO command (0: No command, 1: With command) | 1 |  | 2 |  | 3 |  | 4 |  | 5 |  | 6 |  | 1H | 7 |  | 8 |  | 9 |  | A |  | B |  | C |  | D |  | E |  | F |  |
|                   |                                                                                                                                                                                                                                                                                                                                                                                                                                                                                                                                                                                                                                                                                                                                                                         | Bit | Details                                      |         |    |   |                                              |   |  |   |  |   |  |   |  |   |  |   |  |    |   |  |   |  |   |  |   |  |   |  |   |  |   |  |   |  |   |  |
| 1L                |                                                                                                                                                                                                                                                                                                                                                                                                                                                                                                                                                                                                                                                                                                                                                                         | 0   | STO command (0: No command, 1: With command) |         |    |   |                                              |   |  |   |  |   |  |   |  |   |  |   |  |    |   |  |   |  |   |  |   |  |   |  |   |  |   |  |   |  |   |  |
|                   |                                                                                                                                                                                                                                                                                                                                                                                                                                                                                                                                                                                                                                                                                                                                                                         | 1   |                                              |         |    |   |                                              |   |  |   |  |   |  |   |  |   |  |   |  |    |   |  |   |  |   |  |   |  |   |  |   |  |   |  |   |  |   |  |
|                   |                                                                                                                                                                                                                                                                                                                                                                                                                                                                                                                                                                                                                                                                                                                                                                         | 2   |                                              |         |    |   |                                              |   |  |   |  |   |  |   |  |   |  |   |  |    |   |  |   |  |   |  |   |  |   |  |   |  |   |  |   |  |   |  |
|                   |                                                                                                                                                                                                                                                                                                                                                                                                                                                                                                                                                                                                                                                                                                                                                                         | 3   |                                              |         |    |   |                                              |   |  |   |  |   |  |   |  |   |  |   |  |    |   |  |   |  |   |  |   |  |   |  |   |  |   |  |   |  |   |  |
|                   |                                                                                                                                                                                                                                                                                                                                                                                                                                                                                                                                                                                                                                                                                                                                                                         | 4   |                                              |         |    |   |                                              |   |  |   |  |   |  |   |  |   |  |   |  |    |   |  |   |  |   |  |   |  |   |  |   |  |   |  |   |  |   |  |
|                   |                                                                                                                                                                                                                                                                                                                                                                                                                                                                                                                                                                                                                                                                                                                                                                         | 5   |                                              |         |    |   |                                              |   |  |   |  |   |  |   |  |   |  |   |  |    |   |  |   |  |   |  |   |  |   |  |   |  |   |  |   |  |   |  |
|                   |                                                                                                                                                                                                                                                                                                                                                                                                                                                                                                                                                                                                                                                                                                                                                                         | 6   |                                              |         |    |   |                                              |   |  |   |  |   |  |   |  |   |  |   |  |    |   |  |   |  |   |  |   |  |   |  |   |  |   |  |   |  |   |  |
| 1H                |                                                                                                                                                                                                                                                                                                                                                                                                                                                                                                                                                                                                                                                                                                                                                                         | 7   |                                              |         |    |   |                                              |   |  |   |  |   |  |   |  |   |  |   |  |    |   |  |   |  |   |  |   |  |   |  |   |  |   |  |   |  |   |  |
|                   |                                                                                                                                                                                                                                                                                                                                                                                                                                                                                                                                                                                                                                                                                                                                                                         | 8   |                                              |         |    |   |                                              |   |  |   |  |   |  |   |  |   |  |   |  |    |   |  |   |  |   |  |   |  |   |  |   |  |   |  |   |  |   |  |
|                   |                                                                                                                                                                                                                                                                                                                                                                                                                                                                                                                                                                                                                                                                                                                                                                         | 9   |                                              |         |    |   |                                              |   |  |   |  |   |  |   |  |   |  |   |  |    |   |  |   |  |   |  |   |  |   |  |   |  |   |  |   |  |   |  |
|                   |                                                                                                                                                                                                                                                                                                                                                                                                                                                                                                                                                                                                                                                                                                                                                                         | A   |                                              |         |    |   |                                              |   |  |   |  |   |  |   |  |   |  |   |  |    |   |  |   |  |   |  |   |  |   |  |   |  |   |  |   |  |   |  |
|                   |                                                                                                                                                                                                                                                                                                                                                                                                                                                                                                                                                                                                                                                                                                                                                                         | B   |                                              |         |    |   |                                              |   |  |   |  |   |  |   |  |   |  |   |  |    |   |  |   |  |   |  |   |  |   |  |   |  |   |  |   |  |   |  |
|                   |                                                                                                                                                                                                                                                                                                                                                                                                                                                                                                                                                                                                                                                                                                                                                                         | C   |                                              |         |    |   |                                              |   |  |   |  |   |  |   |  |   |  |   |  |    |   |  |   |  |   |  |   |  |   |  |   |  |   |  |   |  |   |  |
|                   |                                                                                                                                                                                                                                                                                                                                                                                                                                                                                                                                                                                                                                                                                                                                                                         | D   |                                              |         |    |   |                                              |   |  |   |  |   |  |   |  |   |  |   |  |    |   |  |   |  |   |  |   |  |   |  |   |  |   |  |   |  |   |  |
|                   | E                                                                                                                                                                                                                                                                                                                                                                                                                                                                                                                                                                                                                                                                                                                                                                       |     |                                              |         |    |   |                                              |   |  |   |  |   |  |   |  |   |  |   |  |    |   |  |   |  |   |  |   |  |   |  |   |  |   |  |   |  |   |  |
|                   | F                                                                                                                                                                                                                                                                                                                                                                                                                                                                                                                                                                                                                                                                                                                                                                       |     |                                              |         |    |   |                                              |   |  |   |  |   |  |   |  |   |  |   |  |    |   |  |   |  |   |  |   |  |   |  |   |  |   |  |   |  |   |  |
| Safety command 1H |                                                                                                                                                                                                                                                                                                                                                                                                                                                                                                                                                                                                                                                                                                                                                                         |     |                                              |         |    |   |                                              |   |  |   |  |   |  |   |  |   |  |   |  |    |   |  |   |  |   |  |   |  |   |  |   |  |   |  |   |  |   |  |

| Display items     | Details                                                                                                                                                                                                                                                                                                                                                                                                                                                                                                                                                                                                                                                                                                                                                                                                                                                                                                                                                                                |                                                                 |         |         |    |   |                                               |   |  |   |                                              |   |                                                                 |   |                                                                 |   |   |   |  |   |   |  |    |   |    |   |  |   |  |   |  |   |  |   |  |   |  |   |  |   |  |
|-------------------|----------------------------------------------------------------------------------------------------------------------------------------------------------------------------------------------------------------------------------------------------------------------------------------------------------------------------------------------------------------------------------------------------------------------------------------------------------------------------------------------------------------------------------------------------------------------------------------------------------------------------------------------------------------------------------------------------------------------------------------------------------------------------------------------------------------------------------------------------------------------------------------------------------------------------------------------------------------------------------------|-----------------------------------------------------------------|---------|---------|----|---|-----------------------------------------------|---|--|---|----------------------------------------------|---|-----------------------------------------------------------------|---|-----------------------------------------------------------------|---|---|---|--|---|---|--|----|---|----|---|--|---|--|---|--|---|--|---|--|---|--|---|--|---|--|
| Safety command 2L | <p>This displays the data sent to the drive.</p> <table border="1" data-bbox="513 277 1359 967"> <thead> <tr> <th></th> <th>Bit</th> <th>Details</th> </tr> </thead> <tbody> <tr> <td rowspan="5">2L</td> <td>0</td> <td></td> </tr> <tr> <td>1</td> <td></td> </tr> <tr> <td>2</td> <td>SBC command (0: No command, 1: With command)</td> </tr> <tr> <td>3</td> <td>SBC command for SBT (1CH side) (0: No command, 1: With command)</td> </tr> <tr> <td>4</td> <td>SBC command for SBT (2CH side) (0: No command, 1: With command)</td> </tr> <tr> <td></td> <td>5</td> <td></td> </tr> <tr> <td></td> <td>6</td> <td></td> </tr> <tr> <td></td> <td>7</td> <td></td> </tr> <tr> <td rowspan="8">2H</td> <td>8</td> <td></td> </tr> <tr> <td>9</td> <td></td> </tr> <tr> <td>A</td> <td></td> </tr> <tr> <td>B</td> <td></td> </tr> <tr> <td>C</td> <td></td> </tr> <tr> <td>D</td> <td></td> </tr> <tr> <td>E</td> <td></td> </tr> <tr> <td>F</td> <td></td> </tr> </tbody> </table> |                                                                 | Bit     | Details | 2L | 0 |                                               | 1 |  | 2 | SBC command (0: No command, 1: With command) | 3 | SBC command for SBT (1CH side) (0: No command, 1: With command) | 4 | SBC command for SBT (2CH side) (0: No command, 1: With command) |   | 5 |   |  | 6 |   |  | 7  |   | 2H | 8 |  | 9 |  | A |  | B |  | C |  | D |  | E |  | F |  |
|                   |                                                                                                                                                                                                                                                                                                                                                                                                                                                                                                                                                                                                                                                                                                                                                                                                                                                                                                                                                                                        | Bit                                                             | Details |         |    |   |                                               |   |  |   |                                              |   |                                                                 |   |                                                                 |   |   |   |  |   |   |  |    |   |    |   |  |   |  |   |  |   |  |   |  |   |  |   |  |   |  |
| 2L                | 0                                                                                                                                                                                                                                                                                                                                                                                                                                                                                                                                                                                                                                                                                                                                                                                                                                                                                                                                                                                      |                                                                 |         |         |    |   |                                               |   |  |   |                                              |   |                                                                 |   |                                                                 |   |   |   |  |   |   |  |    |   |    |   |  |   |  |   |  |   |  |   |  |   |  |   |  |   |  |
|                   | 1                                                                                                                                                                                                                                                                                                                                                                                                                                                                                                                                                                                                                                                                                                                                                                                                                                                                                                                                                                                      |                                                                 |         |         |    |   |                                               |   |  |   |                                              |   |                                                                 |   |                                                                 |   |   |   |  |   |   |  |    |   |    |   |  |   |  |   |  |   |  |   |  |   |  |   |  |   |  |
|                   | 2                                                                                                                                                                                                                                                                                                                                                                                                                                                                                                                                                                                                                                                                                                                                                                                                                                                                                                                                                                                      | SBC command (0: No command, 1: With command)                    |         |         |    |   |                                               |   |  |   |                                              |   |                                                                 |   |                                                                 |   |   |   |  |   |   |  |    |   |    |   |  |   |  |   |  |   |  |   |  |   |  |   |  |   |  |
|                   | 3                                                                                                                                                                                                                                                                                                                                                                                                                                                                                                                                                                                                                                                                                                                                                                                                                                                                                                                                                                                      | SBC command for SBT (1CH side) (0: No command, 1: With command) |         |         |    |   |                                               |   |  |   |                                              |   |                                                                 |   |                                                                 |   |   |   |  |   |   |  |    |   |    |   |  |   |  |   |  |   |  |   |  |   |  |   |  |   |  |
|                   | 4                                                                                                                                                                                                                                                                                                                                                                                                                                                                                                                                                                                                                                                                                                                                                                                                                                                                                                                                                                                      | SBC command for SBT (2CH side) (0: No command, 1: With command) |         |         |    |   |                                               |   |  |   |                                              |   |                                                                 |   |                                                                 |   |   |   |  |   |   |  |    |   |    |   |  |   |  |   |  |   |  |   |  |   |  |   |  |   |  |
|                   | 5                                                                                                                                                                                                                                                                                                                                                                                                                                                                                                                                                                                                                                                                                                                                                                                                                                                                                                                                                                                      |                                                                 |         |         |    |   |                                               |   |  |   |                                              |   |                                                                 |   |                                                                 |   |   |   |  |   |   |  |    |   |    |   |  |   |  |   |  |   |  |   |  |   |  |   |  |   |  |
|                   | 6                                                                                                                                                                                                                                                                                                                                                                                                                                                                                                                                                                                                                                                                                                                                                                                                                                                                                                                                                                                      |                                                                 |         |         |    |   |                                               |   |  |   |                                              |   |                                                                 |   |                                                                 |   |   |   |  |   |   |  |    |   |    |   |  |   |  |   |  |   |  |   |  |   |  |   |  |   |  |
|                   | 7                                                                                                                                                                                                                                                                                                                                                                                                                                                                                                                                                                                                                                                                                                                                                                                                                                                                                                                                                                                      |                                                                 |         |         |    |   |                                               |   |  |   |                                              |   |                                                                 |   |                                                                 |   |   |   |  |   |   |  |    |   |    |   |  |   |  |   |  |   |  |   |  |   |  |   |  |   |  |
| 2H                | 8                                                                                                                                                                                                                                                                                                                                                                                                                                                                                                                                                                                                                                                                                                                                                                                                                                                                                                                                                                                      |                                                                 |         |         |    |   |                                               |   |  |   |                                              |   |                                                                 |   |                                                                 |   |   |   |  |   |   |  |    |   |    |   |  |   |  |   |  |   |  |   |  |   |  |   |  |   |  |
|                   | 9                                                                                                                                                                                                                                                                                                                                                                                                                                                                                                                                                                                                                                                                                                                                                                                                                                                                                                                                                                                      |                                                                 |         |         |    |   |                                               |   |  |   |                                              |   |                                                                 |   |                                                                 |   |   |   |  |   |   |  |    |   |    |   |  |   |  |   |  |   |  |   |  |   |  |   |  |   |  |
|                   | A                                                                                                                                                                                                                                                                                                                                                                                                                                                                                                                                                                                                                                                                                                                                                                                                                                                                                                                                                                                      |                                                                 |         |         |    |   |                                               |   |  |   |                                              |   |                                                                 |   |                                                                 |   |   |   |  |   |   |  |    |   |    |   |  |   |  |   |  |   |  |   |  |   |  |   |  |   |  |
|                   | B                                                                                                                                                                                                                                                                                                                                                                                                                                                                                                                                                                                                                                                                                                                                                                                                                                                                                                                                                                                      |                                                                 |         |         |    |   |                                               |   |  |   |                                              |   |                                                                 |   |                                                                 |   |   |   |  |   |   |  |    |   |    |   |  |   |  |   |  |   |  |   |  |   |  |   |  |   |  |
|                   | C                                                                                                                                                                                                                                                                                                                                                                                                                                                                                                                                                                                                                                                                                                                                                                                                                                                                                                                                                                                      |                                                                 |         |         |    |   |                                               |   |  |   |                                              |   |                                                                 |   |                                                                 |   |   |   |  |   |   |  |    |   |    |   |  |   |  |   |  |   |  |   |  |   |  |   |  |   |  |
|                   | D                                                                                                                                                                                                                                                                                                                                                                                                                                                                                                                                                                                                                                                                                                                                                                                                                                                                                                                                                                                      |                                                                 |         |         |    |   |                                               |   |  |   |                                              |   |                                                                 |   |                                                                 |   |   |   |  |   |   |  |    |   |    |   |  |   |  |   |  |   |  |   |  |   |  |   |  |   |  |
|                   | E                                                                                                                                                                                                                                                                                                                                                                                                                                                                                                                                                                                                                                                                                                                                                                                                                                                                                                                                                                                      |                                                                 |         |         |    |   |                                               |   |  |   |                                              |   |                                                                 |   |                                                                 |   |   |   |  |   |   |  |    |   |    |   |  |   |  |   |  |   |  |   |  |   |  |   |  |   |  |
|                   | F                                                                                                                                                                                                                                                                                                                                                                                                                                                                                                                                                                                                                                                                                                                                                                                                                                                                                                                                                                                      |                                                                 |         |         |    |   |                                               |   |  |   |                                              |   |                                                                 |   |                                                                 |   |   |   |  |   |   |  |    |   |    |   |  |   |  |   |  |   |  |   |  |   |  |   |  |   |  |
| Safety command 2H |                                                                                                                                                                                                                                                                                                                                                                                                                                                                                                                                                                                                                                                                                                                                                                                                                                                                                                                                                                                        |                                                                 |         |         |    |   |                                               |   |  |   |                                              |   |                                                                 |   |                                                                 |   |   |   |  |   |   |  |    |   |    |   |  |   |  |   |  |   |  |   |  |   |  |   |  |   |  |
| Safety status 1L  | <p>This displays the data received from the drive.</p> <table border="1" data-bbox="513 1043 1359 1680"> <thead> <tr> <th></th> <th>Bit</th> <th>Details</th> </tr> </thead> <tbody> <tr> <td rowspan="7">1L</td> <td>0</td> <td>STO status (0: No operation, 1: In operation)</td> </tr> <tr> <td>1</td> <td></td> </tr> <tr> <td>2</td> <td></td> </tr> <tr> <td>3</td> <td></td> </tr> <tr> <td>4</td> <td></td> </tr> <tr> <td>5</td> <td></td> </tr> <tr> <td>6</td> <td></td> </tr> <tr> <td></td> <td>7</td> <td></td> </tr> <tr> <td rowspan="7">1H</td> <td>8</td> <td></td> </tr> <tr> <td>9</td> <td></td> </tr> <tr> <td>A</td> <td></td> </tr> <tr> <td>B</td> <td></td> </tr> <tr> <td>C</td> <td></td> </tr> <tr> <td>D</td> <td></td> </tr> <tr> <td>E</td> <td></td> </tr> <tr> <td>F</td> <td></td> </tr> </tbody> </table>                                                                                                                                          |                                                                 | Bit     | Details | 1L | 0 | STO status (0: No operation, 1: In operation) | 1 |  | 2 |                                              | 3 |                                                                 | 4 |                                                                 | 5 |   | 6 |  |   | 7 |  | 1H | 8 |    | 9 |  | A |  | B |  | C |  | D |  | E |  | F |  |   |  |
|                   |                                                                                                                                                                                                                                                                                                                                                                                                                                                                                                                                                                                                                                                                                                                                                                                                                                                                                                                                                                                        | Bit                                                             | Details |         |    |   |                                               |   |  |   |                                              |   |                                                                 |   |                                                                 |   |   |   |  |   |   |  |    |   |    |   |  |   |  |   |  |   |  |   |  |   |  |   |  |   |  |
| 1L                | 0                                                                                                                                                                                                                                                                                                                                                                                                                                                                                                                                                                                                                                                                                                                                                                                                                                                                                                                                                                                      | STO status (0: No operation, 1: In operation)                   |         |         |    |   |                                               |   |  |   |                                              |   |                                                                 |   |                                                                 |   |   |   |  |   |   |  |    |   |    |   |  |   |  |   |  |   |  |   |  |   |  |   |  |   |  |
|                   | 1                                                                                                                                                                                                                                                                                                                                                                                                                                                                                                                                                                                                                                                                                                                                                                                                                                                                                                                                                                                      |                                                                 |         |         |    |   |                                               |   |  |   |                                              |   |                                                                 |   |                                                                 |   |   |   |  |   |   |  |    |   |    |   |  |   |  |   |  |   |  |   |  |   |  |   |  |   |  |
|                   | 2                                                                                                                                                                                                                                                                                                                                                                                                                                                                                                                                                                                                                                                                                                                                                                                                                                                                                                                                                                                      |                                                                 |         |         |    |   |                                               |   |  |   |                                              |   |                                                                 |   |                                                                 |   |   |   |  |   |   |  |    |   |    |   |  |   |  |   |  |   |  |   |  |   |  |   |  |   |  |
|                   | 3                                                                                                                                                                                                                                                                                                                                                                                                                                                                                                                                                                                                                                                                                                                                                                                                                                                                                                                                                                                      |                                                                 |         |         |    |   |                                               |   |  |   |                                              |   |                                                                 |   |                                                                 |   |   |   |  |   |   |  |    |   |    |   |  |   |  |   |  |   |  |   |  |   |  |   |  |   |  |
|                   | 4                                                                                                                                                                                                                                                                                                                                                                                                                                                                                                                                                                                                                                                                                                                                                                                                                                                                                                                                                                                      |                                                                 |         |         |    |   |                                               |   |  |   |                                              |   |                                                                 |   |                                                                 |   |   |   |  |   |   |  |    |   |    |   |  |   |  |   |  |   |  |   |  |   |  |   |  |   |  |
|                   | 5                                                                                                                                                                                                                                                                                                                                                                                                                                                                                                                                                                                                                                                                                                                                                                                                                                                                                                                                                                                      |                                                                 |         |         |    |   |                                               |   |  |   |                                              |   |                                                                 |   |                                                                 |   |   |   |  |   |   |  |    |   |    |   |  |   |  |   |  |   |  |   |  |   |  |   |  |   |  |
|                   | 6                                                                                                                                                                                                                                                                                                                                                                                                                                                                                                                                                                                                                                                                                                                                                                                                                                                                                                                                                                                      |                                                                 |         |         |    |   |                                               |   |  |   |                                              |   |                                                                 |   |                                                                 |   |   |   |  |   |   |  |    |   |    |   |  |   |  |   |  |   |  |   |  |   |  |   |  |   |  |
|                   | 7                                                                                                                                                                                                                                                                                                                                                                                                                                                                                                                                                                                                                                                                                                                                                                                                                                                                                                                                                                                      |                                                                 |         |         |    |   |                                               |   |  |   |                                              |   |                                                                 |   |                                                                 |   |   |   |  |   |   |  |    |   |    |   |  |   |  |   |  |   |  |   |  |   |  |   |  |   |  |
| 1H                | 8                                                                                                                                                                                                                                                                                                                                                                                                                                                                                                                                                                                                                                                                                                                                                                                                                                                                                                                                                                                      |                                                                 |         |         |    |   |                                               |   |  |   |                                              |   |                                                                 |   |                                                                 |   |   |   |  |   |   |  |    |   |    |   |  |   |  |   |  |   |  |   |  |   |  |   |  |   |  |
|                   | 9                                                                                                                                                                                                                                                                                                                                                                                                                                                                                                                                                                                                                                                                                                                                                                                                                                                                                                                                                                                      |                                                                 |         |         |    |   |                                               |   |  |   |                                              |   |                                                                 |   |                                                                 |   |   |   |  |   |   |  |    |   |    |   |  |   |  |   |  |   |  |   |  |   |  |   |  |   |  |
|                   | A                                                                                                                                                                                                                                                                                                                                                                                                                                                                                                                                                                                                                                                                                                                                                                                                                                                                                                                                                                                      |                                                                 |         |         |    |   |                                               |   |  |   |                                              |   |                                                                 |   |                                                                 |   |   |   |  |   |   |  |    |   |    |   |  |   |  |   |  |   |  |   |  |   |  |   |  |   |  |
|                   | B                                                                                                                                                                                                                                                                                                                                                                                                                                                                                                                                                                                                                                                                                                                                                                                                                                                                                                                                                                                      |                                                                 |         |         |    |   |                                               |   |  |   |                                              |   |                                                                 |   |                                                                 |   |   |   |  |   |   |  |    |   |    |   |  |   |  |   |  |   |  |   |  |   |  |   |  |   |  |
|                   | C                                                                                                                                                                                                                                                                                                                                                                                                                                                                                                                                                                                                                                                                                                                                                                                                                                                                                                                                                                                      |                                                                 |         |         |    |   |                                               |   |  |   |                                              |   |                                                                 |   |                                                                 |   |   |   |  |   |   |  |    |   |    |   |  |   |  |   |  |   |  |   |  |   |  |   |  |   |  |
|                   | D                                                                                                                                                                                                                                                                                                                                                                                                                                                                                                                                                                                                                                                                                                                                                                                                                                                                                                                                                                                      |                                                                 |         |         |    |   |                                               |   |  |   |                                              |   |                                                                 |   |                                                                 |   |   |   |  |   |   |  |    |   |    |   |  |   |  |   |  |   |  |   |  |   |  |   |  |   |  |
|                   | E                                                                                                                                                                                                                                                                                                                                                                                                                                                                                                                                                                                                                                                                                                                                                                                                                                                                                                                                                                                      |                                                                 |         |         |    |   |                                               |   |  |   |                                              |   |                                                                 |   |                                                                 |   |   |   |  |   |   |  |    |   |    |   |  |   |  |   |  |   |  |   |  |   |  |   |  |   |  |
| F                 |                                                                                                                                                                                                                                                                                                                                                                                                                                                                                                                                                                                                                                                                                                                                                                                                                                                                                                                                                                                        |                                                                 |         |         |    |   |                                               |   |  |   |                                              |   |                                                                 |   |                                                                 |   |   |   |  |   |   |  |    |   |    |   |  |   |  |   |  |   |  |   |  |   |  |   |  |   |  |
| Safety status 1H  |                                                                                                                                                                                                                                                                                                                                                                                                                                                                                                                                                                                                                                                                                                                                                                                                                                                                                                                                                                                        |                                                                 |         |         |    |   |                                               |   |  |   |                                              |   |                                                                 |   |                                                                 |   |   |   |  |   |   |  |    |   |    |   |  |   |  |   |  |   |  |   |  |   |  |   |  |   |  |



| Display items        | Details                                                                                                                                                                                                                                                                                                                                                                                                                                                                                                                                                                                                                                                                                                                                                                                                                                                                                                                                                    |                                                                  |     |         |    |   |  |   |  |   |                                               |   |                                                                  |   |                                                                  |   |  |   |  |    |   |  |   |  |   |  |   |  |   |  |   |  |   |  |   |  |   |  |
|----------------------|------------------------------------------------------------------------------------------------------------------------------------------------------------------------------------------------------------------------------------------------------------------------------------------------------------------------------------------------------------------------------------------------------------------------------------------------------------------------------------------------------------------------------------------------------------------------------------------------------------------------------------------------------------------------------------------------------------------------------------------------------------------------------------------------------------------------------------------------------------------------------------------------------------------------------------------------------------|------------------------------------------------------------------|-----|---------|----|---|--|---|--|---|-----------------------------------------------|---|------------------------------------------------------------------|---|------------------------------------------------------------------|---|--|---|--|----|---|--|---|--|---|--|---|--|---|--|---|--|---|--|---|--|---|--|
| Safety status 2L     | This displays the data received from the drive. <table border="1" data-bbox="552 277 1398 967"> <thead> <tr> <th></th> <th>Bit</th> <th>Details</th> </tr> </thead> <tbody> <tr> <td rowspan="7">2L</td> <td>0</td> <td></td> </tr> <tr> <td>1</td> <td></td> </tr> <tr> <td>2</td> <td>SBC status (0: No operation, 1: In operation)</td> </tr> <tr> <td>3</td> <td>SBC status for SBT (1CH side) (0: No operation, 1: In operation)</td> </tr> <tr> <td>4</td> <td>SBC status for SBT (2CH side) (0: No operation, 1: In operation)</td> </tr> <tr> <td>5</td> <td></td> </tr> <tr> <td>6</td> <td></td> </tr> <tr> <td rowspan="7">2H</td> <td>7</td> <td></td> </tr> <tr> <td>8</td> <td></td> </tr> <tr> <td>9</td> <td></td> </tr> <tr> <td>A</td> <td></td> </tr> <tr> <td>B</td> <td></td> </tr> <tr> <td>C</td> <td></td> </tr> <tr> <td>D</td> <td></td> </tr> <tr> <td>E</td> <td></td> </tr> <tr> <td>F</td> <td></td> </tr> </tbody> </table> |                                                                  | Bit | Details | 2L | 0 |  | 1 |  | 2 | SBC status (0: No operation, 1: In operation) | 3 | SBC status for SBT (1CH side) (0: No operation, 1: In operation) | 4 | SBC status for SBT (2CH side) (0: No operation, 1: In operation) | 5 |  | 6 |  | 2H | 7 |  | 8 |  | 9 |  | A |  | B |  | C |  | D |  | E |  | F |  |
|                      | Bit                                                                                                                                                                                                                                                                                                                                                                                                                                                                                                                                                                                                                                                                                                                                                                                                                                                                                                                                                        | Details                                                          |     |         |    |   |  |   |  |   |                                               |   |                                                                  |   |                                                                  |   |  |   |  |    |   |  |   |  |   |  |   |  |   |  |   |  |   |  |   |  |   |  |
| 2L                   | 0                                                                                                                                                                                                                                                                                                                                                                                                                                                                                                                                                                                                                                                                                                                                                                                                                                                                                                                                                          |                                                                  |     |         |    |   |  |   |  |   |                                               |   |                                                                  |   |                                                                  |   |  |   |  |    |   |  |   |  |   |  |   |  |   |  |   |  |   |  |   |  |   |  |
|                      | 1                                                                                                                                                                                                                                                                                                                                                                                                                                                                                                                                                                                                                                                                                                                                                                                                                                                                                                                                                          |                                                                  |     |         |    |   |  |   |  |   |                                               |   |                                                                  |   |                                                                  |   |  |   |  |    |   |  |   |  |   |  |   |  |   |  |   |  |   |  |   |  |   |  |
|                      | 2                                                                                                                                                                                                                                                                                                                                                                                                                                                                                                                                                                                                                                                                                                                                                                                                                                                                                                                                                          | SBC status (0: No operation, 1: In operation)                    |     |         |    |   |  |   |  |   |                                               |   |                                                                  |   |                                                                  |   |  |   |  |    |   |  |   |  |   |  |   |  |   |  |   |  |   |  |   |  |   |  |
|                      | 3                                                                                                                                                                                                                                                                                                                                                                                                                                                                                                                                                                                                                                                                                                                                                                                                                                                                                                                                                          | SBC status for SBT (1CH side) (0: No operation, 1: In operation) |     |         |    |   |  |   |  |   |                                               |   |                                                                  |   |                                                                  |   |  |   |  |    |   |  |   |  |   |  |   |  |   |  |   |  |   |  |   |  |   |  |
|                      | 4                                                                                                                                                                                                                                                                                                                                                                                                                                                                                                                                                                                                                                                                                                                                                                                                                                                                                                                                                          | SBC status for SBT (2CH side) (0: No operation, 1: In operation) |     |         |    |   |  |   |  |   |                                               |   |                                                                  |   |                                                                  |   |  |   |  |    |   |  |   |  |   |  |   |  |   |  |   |  |   |  |   |  |   |  |
|                      | 5                                                                                                                                                                                                                                                                                                                                                                                                                                                                                                                                                                                                                                                                                                                                                                                                                                                                                                                                                          |                                                                  |     |         |    |   |  |   |  |   |                                               |   |                                                                  |   |                                                                  |   |  |   |  |    |   |  |   |  |   |  |   |  |   |  |   |  |   |  |   |  |   |  |
|                      | 6                                                                                                                                                                                                                                                                                                                                                                                                                                                                                                                                                                                                                                                                                                                                                                                                                                                                                                                                                          |                                                                  |     |         |    |   |  |   |  |   |                                               |   |                                                                  |   |                                                                  |   |  |   |  |    |   |  |   |  |   |  |   |  |   |  |   |  |   |  |   |  |   |  |
| 2H                   | 7                                                                                                                                                                                                                                                                                                                                                                                                                                                                                                                                                                                                                                                                                                                                                                                                                                                                                                                                                          |                                                                  |     |         |    |   |  |   |  |   |                                               |   |                                                                  |   |                                                                  |   |  |   |  |    |   |  |   |  |   |  |   |  |   |  |   |  |   |  |   |  |   |  |
|                      | 8                                                                                                                                                                                                                                                                                                                                                                                                                                                                                                                                                                                                                                                                                                                                                                                                                                                                                                                                                          |                                                                  |     |         |    |   |  |   |  |   |                                               |   |                                                                  |   |                                                                  |   |  |   |  |    |   |  |   |  |   |  |   |  |   |  |   |  |   |  |   |  |   |  |
|                      | 9                                                                                                                                                                                                                                                                                                                                                                                                                                                                                                                                                                                                                                                                                                                                                                                                                                                                                                                                                          |                                                                  |     |         |    |   |  |   |  |   |                                               |   |                                                                  |   |                                                                  |   |  |   |  |    |   |  |   |  |   |  |   |  |   |  |   |  |   |  |   |  |   |  |
|                      | A                                                                                                                                                                                                                                                                                                                                                                                                                                                                                                                                                                                                                                                                                                                                                                                                                                                                                                                                                          |                                                                  |     |         |    |   |  |   |  |   |                                               |   |                                                                  |   |                                                                  |   |  |   |  |    |   |  |   |  |   |  |   |  |   |  |   |  |   |  |   |  |   |  |
|                      | B                                                                                                                                                                                                                                                                                                                                                                                                                                                                                                                                                                                                                                                                                                                                                                                                                                                                                                                                                          |                                                                  |     |         |    |   |  |   |  |   |                                               |   |                                                                  |   |                                                                  |   |  |   |  |    |   |  |   |  |   |  |   |  |   |  |   |  |   |  |   |  |   |  |
|                      | C                                                                                                                                                                                                                                                                                                                                                                                                                                                                                                                                                                                                                                                                                                                                                                                                                                                                                                                                                          |                                                                  |     |         |    |   |  |   |  |   |                                               |   |                                                                  |   |                                                                  |   |  |   |  |    |   |  |   |  |   |  |   |  |   |  |   |  |   |  |   |  |   |  |
|                      | D                                                                                                                                                                                                                                                                                                                                                                                                                                                                                                                                                                                                                                                                                                                                                                                                                                                                                                                                                          |                                                                  |     |         |    |   |  |   |  |   |                                               |   |                                                                  |   |                                                                  |   |  |   |  |    |   |  |   |  |   |  |   |  |   |  |   |  |   |  |   |  |   |  |
| E                    |                                                                                                                                                                                                                                                                                                                                                                                                                                                                                                                                                                                                                                                                                                                                                                                                                                                                                                                                                            |                                                                  |     |         |    |   |  |   |  |   |                                               |   |                                                                  |   |                                                                  |   |  |   |  |    |   |  |   |  |   |  |   |  |   |  |   |  |   |  |   |  |   |  |
| F                    |                                                                                                                                                                                                                                                                                                                                                                                                                                                                                                                                                                                                                                                                                                                                                                                                                                                                                                                                                            |                                                                  |     |         |    |   |  |   |  |   |                                               |   |                                                                  |   |                                                                  |   |  |   |  |    |   |  |   |  |   |  |   |  |   |  |   |  |   |  |   |  |   |  |
| Safety status 2H     |                                                                                                                                                                                                                                                                                                                                                                                                                                                                                                                                                                                                                                                                                                                                                                                                                                                                                                                                                            |                                                                  |     |         |    |   |  |   |  |   |                                               |   |                                                                  |   |                                                                  |   |  |   |  |    |   |  |   |  |   |  |   |  |   |  |   |  |   |  |   |  |   |  |
| Safe position FB     | This displays the encoder position information from the drive to NC.                                                                                                                                                                                                                                                                                                                                                                                                                                                                                                                                                                                                                                                                                                                                                                                                                                                                                       |                                                                  |     |         |    |   |  |   |  |   |                                               |   |                                                                  |   |                                                                  |   |  |   |  |    |   |  |   |  |   |  |   |  |   |  |   |  |   |  |   |  |   |  |
| Saf detector connect | This displays the safety encoder connection status.<br>0: No connection<br>1: With connection                                                                                                                                                                                                                                                                                                                                                                                                                                                                                                                                                                                                                                                                                                                                                                                                                                                              |                                                                  |     |         |    |   |  |   |  |   |                                               |   |                                                                  |   |                                                                  |   |  |   |  |    |   |  |   |  |   |  |   |  |   |  |   |  |   |  |   |  |   |  |
| Safety status 2L     | This displays the data received from the drive.                                                                                                                                                                                                                                                                                                                                                                                                                                                                                                                                                                                                                                                                                                                                                                                                                                                                                                            |                                                                  |     |         |    |   |  |   |  |   |                                               |   |                                                                  |   |                                                                  |   |  |   |  |    |   |  |   |  |   |  |   |  |   |  |   |  |   |  |   |  |   |  |

### 11.5.4 Safety Observation Screen (Version Display)

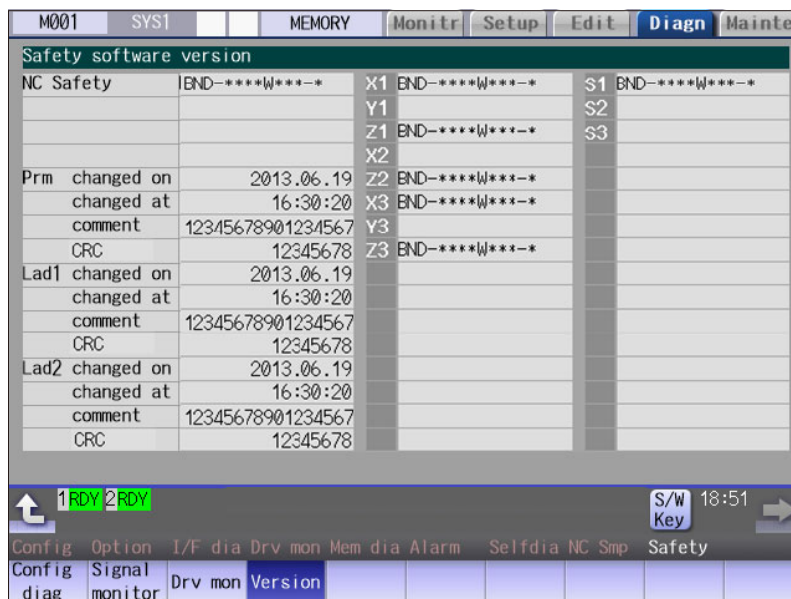
Software version about smart safety observation is displayed on the version display screen.



#### Display items

| Display items              | Details                                                                                                                                                                                                                                                                                                                                   |
|----------------------------|-------------------------------------------------------------------------------------------------------------------------------------------------------------------------------------------------------------------------------------------------------------------------------------------------------------------------------------------|
| NC Safety                  | This displays the smart safety observation software version of the NC system.                                                                                                                                                                                                                                                             |
| Parameters                 | This displays the safety parameter changed date and time, comment and CRC.                                                                                                                                                                                                                                                                |
| Lad 1, 2                   | This displays the safety PLC ladder 1, 2 changed date and time, comment and CRC.                                                                                                                                                                                                                                                          |
| Servo axis (up to 32 axes) | This displays the safety software version of servo axis.<br>The version only for axis of the safety servo unit is displayed.<br>Change the display item with  or  . |
| Spindle (up to 8 spindles) | This displays the safety software version of spindle.<br>The version only for spindle of the safety spindle unit is displayed.                                                                                                                                                                                                            |

## Performing a Backup Operation



The Input/Output screen of the maintenance (Mainte) screen is used to carry out NC data input/output between the NC internal memory and the external input/output devices. Here, the hard disk built into the NC device is also treated as external devices.

When the multi-part system program management is valid (#1285 ext21/bit0 =1) and the selected device is the NC memory, a program input and output will be executed across all part systems in batch if a parameter "#1285 ext21/bit2" (Multi-part system program management) is set to "0". When it is set to "1", the program input and output will be executed for the program of displayed part system.

However, when the machining program is transferred from the NC memory to the device other than the NC memory, the transfer will be executed across all part systems in batch if "#1286 ext22/bit5" (Selection of multi-part system program input/output method) is set to "0". If it is set to "1", only displayed part system's program will be transferred.

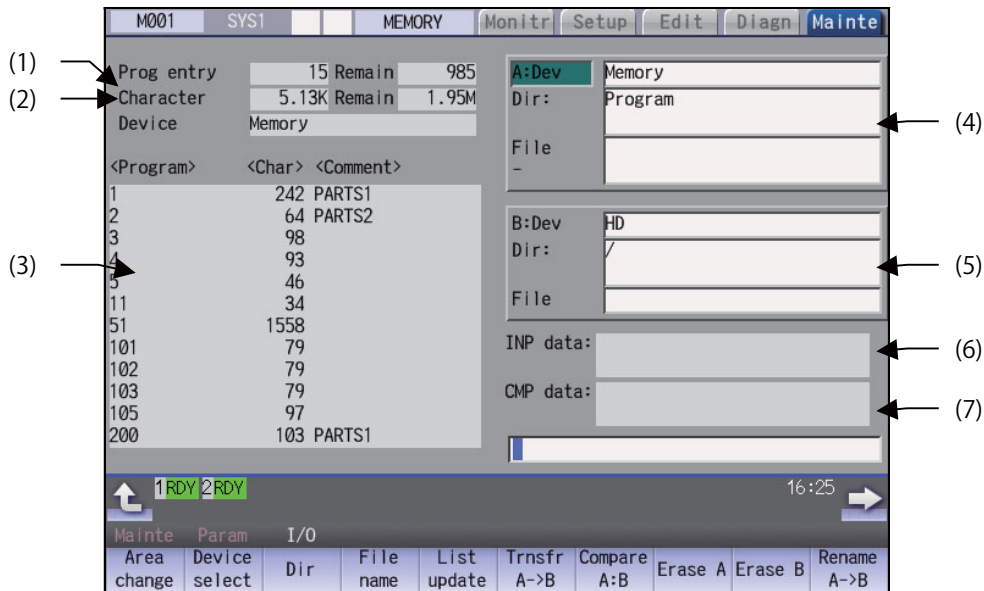

**Display items**

| Display items                                        | Details                                                                                                                                                                                                                                                                                                                                                                                                                                                                          |
|------------------------------------------------------|----------------------------------------------------------------------------------------------------------------------------------------------------------------------------------------------------------------------------------------------------------------------------------------------------------------------------------------------------------------------------------------------------------------------------------------------------------------------------------|
| (1) Number of programs registered and remainder (*1) | This displays the registration information of machining program of the selected device.<br>Number of programs registered : This displays the number of programs previously registered as user machining programs.<br>Remain: This displays the remaining number of programs that can be registered.<br>When memory is selected as the device, the total of the number of programs registered and the remainder is the maximum number of registrations set in the specifications. |
| (2) Number of memory characters and remainder (*1)   | This displays the number of characters of the machining program of the selected device.<br>Number of memory characters: This displays the number of characters previously registered as user machining programs.<br>Remain: This displays the remaining number of characters that can be registered.<br>The total of the number of memory characters and the remainder is the maximum number of memory characters set in the specifications.                                     |

| Display items             | Details                                                                                                                                                                                                                                                                                                                                                                                                                                                                                                                                                                                                                                                                                                                                                                                                                                                                                                                                                                                                                                                                                                                                                                                                                                                                                                                                                                                                                                                                                                                                                                                                                                                                                                    |
|---------------------------|------------------------------------------------------------------------------------------------------------------------------------------------------------------------------------------------------------------------------------------------------------------------------------------------------------------------------------------------------------------------------------------------------------------------------------------------------------------------------------------------------------------------------------------------------------------------------------------------------------------------------------------------------------------------------------------------------------------------------------------------------------------------------------------------------------------------------------------------------------------------------------------------------------------------------------------------------------------------------------------------------------------------------------------------------------------------------------------------------------------------------------------------------------------------------------------------------------------------------------------------------------------------------------------------------------------------------------------------------------------------------------------------------------------------------------------------------------------------------------------------------------------------------------------------------------------------------------------------------------------------------------------------------------------------------------------------------------|
| (3) List (*2)             | <p>This displays a contents list (directory and file name) of the directory in the setting column (file setting column A or B) where the cursor is currently located.</p> <p>&lt;Program&gt;</p> <p>When [Memory] is selected for the device, this displays the file name (program No.) of the machining programs already registered. The file names are displayed in order from the smallest number, from 1 to 99999999.</p> <p>When a device other than [Memory] is selected, this displays the file name and directory to be included in the directory that is set in the current setting column.</p> <p>When the number of characters exceeds the maximum (12 characters with the comment column, 29 characters without the comment column), the excess is indicated as "***".</p> <p>&lt;Char&gt;</p> <p>This displays the size of each file. When [Memory] is selected for the device, this displays the number of characters of the machining program.</p> <p>When directory is selected, this displays "DIR".</p> <p>&lt;Comment&gt;</p> <p>This displays the comment (up to 17 alphanumeric characters and symbols) of each file. The date which the file is updated is displayed for the HD, memory card, DS, USB memory or Ethernet.</p> <p>The display can be switched as follows depending on the parameter "#8981 NCmemory date disp" setting: (*3)</p> <p>When #8981 is set to "0", the machining program comment is displayed.</p> <p>When #8981 is set to "1", the file update date/time is displayed.</p> <p>When the comment of the NC memory exceeds the number of display characters (17 characters), the exceeded part is not displayed. The excess is not abbreviated to "***".</p> |
| (4) File setting column A | This sets the device, directory, and file name for which the transmission, compare, and erase functions are used.                                                                                                                                                                                                                                                                                                                                                                                                                                                                                                                                                                                                                                                                                                                                                                                                                                                                                                                                                                                                                                                                                                                                                                                                                                                                                                                                                                                                                                                                                                                                                                                          |
| (5) File setting column B | <p>When transferring, the file name of the transfer origin file is set. When renaming, the file name before renaming is set. When erasing, the erasing range is set.</p> <p>When the number of characters exceeds 28, the excess is not displayed.</p> <p>As for the device and directory, the setting values are retained even when the power is turned OFF. (*4)</p>                                                                                                                                                                                                                                                                                                                                                                                                                                                                                                                                                                                                                                                                                                                                                                                                                                                                                                                                                                                                                                                                                                                                                                                                                                                                                                                                     |
| (6) Input data            | This displays the data being transferred.                                                                                                                                                                                                                                                                                                                                                                                                                                                                                                                                                                                                                                                                                                                                                                                                                                                                                                                                                                                                                                                                                                                                                                                                                                                                                                                                                                                                                                                                                                                                                                                                                                                                  |
| (7) Comparison data       | This displays the data being compared. If an error occurs while comparing data, the block for which the error occurred is displayed.                                                                                                                                                                                                                                                                                                                                                                                                                                                                                                                                                                                                                                                                                                                                                                                                                                                                                                                                                                                                                                                                                                                                                                                                                                                                                                                                                                                                                                                                                                                                                                       |

(\*1) Some items may not be displayed depending on the device.

○ : Displayed    × : Not displayed

| Display item/Device           | Memory | HD | Serial | Memory card | DS/USB memory | Ethernet |
|-------------------------------|--------|----|--------|-------------|---------------|----------|
| Number of programs registered | ○      | ○  | ×      | ○           | ○             | ○        |
| Remain                        | ○      | ×  | ×      | ×           | ×             | ×        |
| Number of memory characters   | ○      | ○  | ×      | ○           | ○             | ○*       |
| Remain                        | ○      | ○  | ×      | ○           | ○             | ×        |
| List                          | ○      | ○  | ×      | ○           | ○             | ○        |

\* When the parameter "#97\*1 Host n no total siz" is set to "1", the number of host memory characters will not appear.

(\*2) When the device is serial, an empty list is displayed.

(\*3) For the program list view of the NC memory, the program comment is displayed when the multi-part system program management is valid (#1285 ext21/bit0 = 1), regardless of the parameter setting of "8981 NCmemory date disp".

(\*4) When the number of characters in the directory path (full path) from the root directory exceeds 100, the directory path is not retained, but a previously set directory path containing 100 characters or less retained. Maximum 37 characters can be entered as a file name.

When the device is "Memory", the initial directory display is "Program" except when selecting directory from the menu. When the device is "Ethernet", the initial directory display is "/" (root).



## Menus

| Menus           | Details                                                                                                                                                                                                                                                                               |
|-----------------|---------------------------------------------------------------------------------------------------------------------------------------------------------------------------------------------------------------------------------------------------------------------------------------|
| Area change     | This changes the setting area to file setting column A (transfer origin) or file setting column B (transfer destination).<br>The display of the valid area (A or B) is highlighted.                                                                                                   |
| Device select   | This displays the sub-menu of the machining program storage area.<br>When the sub-menu is selected, the device is confirmed, and if a directory exists it is set in the root.<br>The memory is selected as the default.                                                               |
| Dir             | This menu sets the directory that carries out input/ output operations, and is on standby for input. Note that when memory is selected for the device, the directory can be selected from the sub-menu.                                                                               |
| File name       | This menu sets the file name that carries out input/ output operations, and is on standby for input.<br>When memory is selected for the device, setting is not necessary if the directory is not the program.                                                                         |
| List update     | This updates the list. The list of the directly selected in the currently valid file setting column (A/B) is updated.                                                                                                                                                                 |
| Trnsfr A->B     | This copies the file in file setting column A (transfer origin) to the file setting column B (transfer destination). (The transfer origin file is not changed.) A message appears during transfer and when the transfer is completed.                                                 |
| Compare A:B     | This compares the files in file setting column A (transfer origin) and file setting column B (transfer destination).                                                                                                                                                                  |
| Erase A         | This erases the file in file setting column A.<br><Note><br>♦The NC memory (excluding programs), serial and Ethernet (host file) cannot be erased.                                                                                                                                    |
| Erase B         | This erases the file in file setting column B.<br><Note><br>♦The NC memory (excluding programs), serial and Ethernet (host file) cannot be erased.                                                                                                                                    |
| Rename A□ B     | This changes the name of the file in file setting column A (transfer origin) to the name of the file in file setting column B (transfer destination).<br><Note><br>♦The same device must be selected for A and B.<br>The NC memory (excluding programs) and serial cannot be renamed. |
| Comment nondisp | This changes whether to show or hide the comment field.                                                                                                                                                                                                                               |
| Dir create      | This creates a new directory in the directory of the currently valid file setting column (A/B).<br>The directory can be created when HD, memory card or USB memory is selected for the device.                                                                                        |
| Merge B□ A      | This adds the contents of the file in file setting column B to that of in file setting column A. (The file in file setting column B is not changed.)<br><Note><br>♦The NC memory (excluding programs), serial and Ethernet (host file) cannot be merged.                              |
| MemCrd format   | Format the memory card (front-side SD card).                                                                                                                                                                                                                                          |
| DS format       | Format the memory card DS (built-in SD card).                                                                                                                                                                                                                                         |
| USB Mem format  | Format the USB memory.                                                                                                                                                                                                                                                                |
| Stop            | This interrupts the process (transfer, compare, etc.) during its execution.                                                                                                                                                                                                           |

12 Performing a Backup Operation

When setting the file setting field A or B device, directory and file name on this screen, the area containing these must be valid.

The display area can be changed by pressing the menu key ([Area change]) or the cursor key [↑] and [↓].

After changing, the data setting operation is valid in that area.

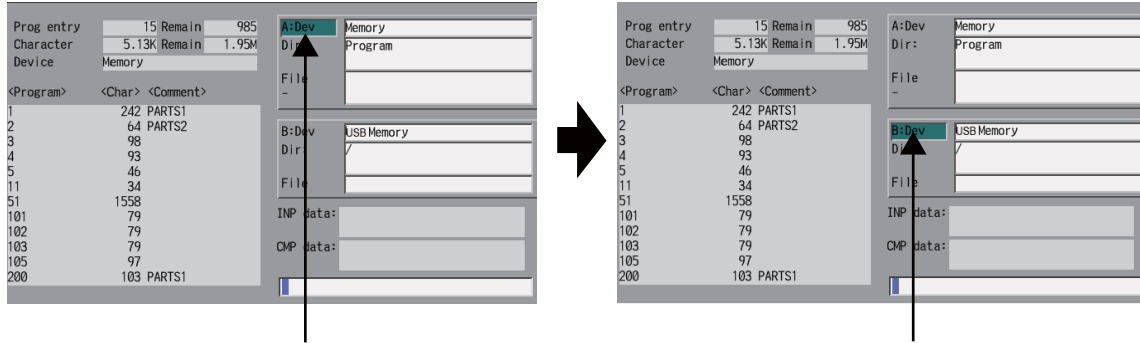

File setting column A is valid.

File setting column B is valid.

**Changing the valid file setting field**

When file setting column A (top) is valid

- (1) Press the menu [Area change].



The file setting column B (bottom) is validated.

This can also be changed with the cursor key [↓].

## 12.1 Selecting a Device, Directory and File



### File selection sequence

Designate the device where the target file is located. → Select from the sub menu.



Designate the directory with a full path. → Input the full path or select from the list.



Designate the file name. → Input the file name or select from the list.

### Menus

Sub-menus of [Device select]

| Menus       | Details                                                                                                                                                |
|-------------|--------------------------------------------------------------------------------------------------------------------------------------------------------|
| Memory      | This selects the NC memory (program, parameter, PLC program, NC data).                                                                                 |
| HD          | This selects the hard disk.<br>This is not displayed on M800S Series, M80 Series, E80 Series, and non-Windows-based display unit of M800W/M80W Series. |
| Serial      | This selects the RS-232C device (PC, tape, etc.).                                                                                                      |
| Memory card | This selects the front-side SD card.                                                                                                                   |
| DS          | [M800W/M80W]<br>This selects the SD card in the control unit.<br>[M800S/M80/E80]<br>This selects the back-side SD card of the display unit.            |
| Ethnet      | This selects the Ethernet-connected host computer.                                                                                                     |
| USB Memory  | This selects USB memory.                                                                                                                               |

Sub-menus of [Dir] (other than memory) and [File name]

| Menus          | Details                                                                                                                                                                                                                                                                                                                                                                            |
|----------------|------------------------------------------------------------------------------------------------------------------------------------------------------------------------------------------------------------------------------------------------------------------------------------------------------------------------------------------------------------------------------------|
| From list      | The cursor appears in the list display. The list contents can be selected with the [INPUT] key.<br>When a directory is selected, the contents of the selected directory are displayed in the list. Continued selection is possible.<br>When a file name is selected, the file name is temporarily displayed in the input area. When the [INPUT] key is pressed again, it is fixed. |
| File name in   | This copies the file name of the selected device to input area.                                                                                                                                                                                                                                                                                                                    |
| Clear filename | This deletes the file name of the selected device.                                                                                                                                                                                                                                                                                                                                 |
| Top jump       | [In normal mode]<br>The contents of the first page in the list are displayed.<br>[When importing data from the list]<br>The contents of the first page in the list are displayed, and the cursor moves to the top row.                                                                                                                                                             |
| Bottom jump    | [In normal mode]<br>The contents of the last page in the list are displayed.<br>[When importing data from the list]<br>The contents of the last page in the list are displayed, and the cursor moves to the bottom row.                                                                                                                                                            |

## Sub-menus of [Dir] (memory)

| Menus           | Details                                                                                                          |
|-----------------|------------------------------------------------------------------------------------------------------------------|
| Program         | "Program" appears in the directory.<br>The "File" column is blank.                                               |
| Program all     | "Program all" is displayed in the "Dir" column.<br>The "File" column is blank.                                   |
| Tool offset     | "Tool offset" is displayed in the "Dir" column.<br>"TOOL.OFS" is displayed in the "File" column.                 |
| Variabl         | "Variable" is displayed in the Dir column.<br>"COMMON.VAR" is displayed in the "File" column.                    |
| Coord offset    | "Workpiece offset" is displayed in the "Dir" column.<br>"WORK.OFS" is displayed in the "File" column.            |
| All T data      | "All tool data" is displayed in the "Dir" column.<br>"TOOLALL.DAT" is displayed in the "File" column.            |
| Param           | "Parameter" is displayed in the "Dir" column.<br>"ALL.PRM" is displayed in the "File" column.                    |
| System config   | "System config" is displayed in the "Dir" column.<br>"ASSEMBLY.INF" is displayed in the "File" column.           |
| Safety param    | "Safety parameter" is displayed in the "Dir" column.<br>"SAFE PARA.BIN" is displayed in the "File" column.       |
| Smp data        | "Smp data" is displayed in the "Dir" column.<br>"NCSAMP.CSV" is displayed in the "File" column.                  |
| Open SRAM       | "Open SRAM" is displayed in the "Dir" column.<br>"SRAMOPEN.DAT" is displayed in the "File" column.               |
| Open device     | "Open device" is displayed in the "Dir" column.<br>"DEVOPEN.DAT" is displayed in the "File" column.              |
| WorkSet ErrComp | "WorkSetErrComp" is displayed in the "Dir" column.<br>"WKPOS.OFS" is displayed in the "File" column.             |
| Device Net      | "DeviceNet" is displayed in the "Dir" column.<br>"DEVICENT.PRM" is displayed in the "File" column.               |
| Surface Data    | "Surface Data" is displayed in the "Dir" column.<br>"RNAVI.DAT" is displayed in the "File" column.               |
| Interfr data    | "Interference data" is displayed in the "Dir" column.<br>"OBSTACL.DAT" is displayed in the "File" column.        |
| System param    | "System parameter" is displayed in the "Dir" column.<br>"SYSTEM.PRM" is displayed in the "File" column.          |
| Option          | "Option" is displayed in the "Dir" column.<br>"OPTION" is displayed in the "File" column.                        |
| Ladder          | "Ladder" is displayed in the "Dir" column.<br>"USERPLC.LAD" is displayed in the "File" column.                   |
| Email address   | "Email transmission address" displayed in the "Dir" column.<br>"MAILADDR.DAT" is displayed in the "File" column. |
| Teach data      | "Teach data" displayed in the "Dir" column.<br>"TEACHPOS.DAT" is displayed in the "File" column.                 |

### Selecting methods for device, directory, and file name



| Device                   | Designation target file                                                                                         | Designation method       |                                                                                      |                                                                                  |
|--------------------------|-----------------------------------------------------------------------------------------------------------------|--------------------------|--------------------------------------------------------------------------------------|----------------------------------------------------------------------------------|
|                          |                                                                                                                 | Device                   | Directory                                                                            | File name                                                                        |
| NC memory                | <ul style="list-style-type: none"> <li>•Machining program</li> <li>•User macro</li> <li>•Fixed cycle</li> </ul> | Select from the sub-menu | -<br>(Default)                                                                       | Key input in the input area, then press the [INPUT] key.<br>Select from the list |
|                          | Other than the machining program                                                                                | Select from the sub-menu | Key input in the input area, then press the [INPUT] key.<br>Select from the sub-menu | -<br>(Fixed)                                                                     |
| Other than the NC memory | All                                                                                                             | Select from the sub-menu | Key input in the input area, then press the [INPUT] key.                             | Key input in the input area, then press the [INPUT] key.                         |
|                          |                                                                                                                 |                          | Select from the list                                                                 | Select from the list                                                             |

The device can be selected from the sub-menu. (The devices that can be used will differ depending on the specifications.) One of the following methods can be used to designate the directory (for devices other than the NC memory) and file name.

- Designate the directory path (full path) or file name in the input area and press the [INPUT] key.
- Press sub-menu [From list] of the menu [Dir] or [File name]. Move the cursor to the target directory or file name, and press the [INPUT] key.

A wildcard (\*) can be used when selecting a file name.

### Notes when selecting a file

- (1) During directory and file name setting, the designated directory, path or file name will be set, even if it does not actually exist. This will not cause an error. Note that the previously set directory is overwritten.
- (2) When a file in the NC memory other than a machining program is designated, it is not necessary to set the file name. (The file name is fixed.)
- (3) When a file name is selected from the menu, it first is displayed in the input area. However, at this time the file name has not yet been fixed. Press the [INPUT] key again to fix the file name.
- (4) If you press the  key or the  key when setting a file name, the file name in the input area is erased.
- (5) When selecting a fixed cycle program, it is necessary to set the basic common parameter "#1166 fixpro". Furthermore, select "Memory" for the device, and "Program" for the directory.

### Initial directory when the Ethernet is selected

An initial directory is specified at turning the power ON by the following parameter.

- #9706 Host No.
- #9714 Host1 directory
- #9734 Host2 directory
- #9754 Host3 directory
- #9774 Host4 directory

**Selecting a NC memory program**

- (1) Press the menu [Device select].
- (2) Press the menu [Memory].
- (3) Press the menu [File name].

- (4) Input the file name.  
 <When inputting the file name from the input area>  
 Input the file name.  
 10013 [INPUT]



The selected file name appears.

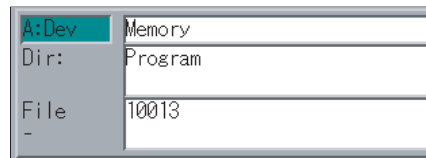

- <When selecting the file name from the list>  
 Press the menu [From list].



The cursor appears in the list.

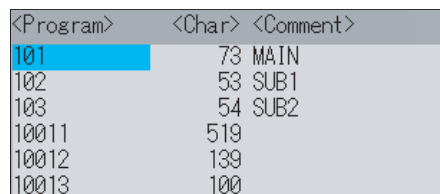

- (5) Move the cursor to the file name to be selected, and set.  
 [↑], [↓] [INPUT]



Selected file name is displayed in the input area.



- (6) Press the [INPUT] key.



The selected file name appears.

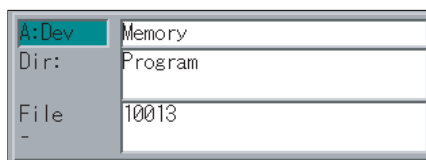

**Designating multiple files**

<Designating multiple serial files>

Multiple serial files can be transferred, compared and erased in the file setting column A. Set as follows in this case.

File name:  
 (Upper row) First file name  
 (Lower row) Last file name



|       |         |
|-------|---------|
| A:Dev | Memory  |
| Dir:  | Program |
| File  | 10013   |
| -     | 10050   |

<Using a wildcard>

A wildcard (\*) can be used for the file name.

**Note**

(1) When serial or Anshin-net server is used, multiple files cannot be compared.

File: \*  
 -



All files will be selected.

|       |         |
|-------|---------|
| A:Dev | Memory  |
| Dir:  | Program |
| File  | *       |
| -     |         |

**Selecting a file other than a program in NC memory**

- (1) Press the menu [Device select].
- (2) Press the menu [Memory].
- (3) Select the menu [Dir].
- (4) Press the menu [Tool offset].



The directory and file name appear.

|       |             |
|-------|-------------|
| A:Dev | Memory      |
| Dir:  | Tool offset |
| File  | TOOL.OFS    |
| -     |             |

**Note**

- (1) The file name for each directory is fixed. For the file name, refer to "12.8.2 List of File Names".
- (2) When the menu [Program] or [Program all] is selected, the setting of "File name" column is cleared.



Selecting a device file other than the NC memory (When separately selecting the directory and file name.)

- (1) Press the menu [Device select].
- (2) Select the device.
- (3) Select the menu [Dir].
- (4) Select a file.  
 <When inputting the directory from the input area>  
 Input the directory path as a full path.  
 /PRG/PRECU T [INPUT]

<When selecting the directory from the list>  
 Press the menu [From list].





The cursor appears in the list.

| <Program> | <Char> | <Comment> |
|-----------|--------|-----------|
| .         | DIR    |           |
| ..        | DIR    |           |
| NCDATA    | DIR    |           |
| PRG       | DIR    |           |

- (5) Move the cursor to the directory to be selected and set.  
 [↑], [↓] [INPUT]

Repeat this operation until the cursor arrives at the target directory.

When the target directory is reached, press the  key or the  key and quit the mode for inputting the directory.



The selected directory appears in the data setting column.  
 The contents of the selected directory appear in the list.

|       |              |
|-------|--------------|
| A:Dev | USB Memory   |
| Dir:  | /PRG/PRECU T |
| File  | -            |

**Note**

- (1) Refer to next section "Selecting a device file other than the NC memory (When simultaneously selecting the directory and file name.)" procedure (3) or later for method of file designation.

**Selecting a device file other than the NC memory (When simultaneously selecting the directory and file name.)**

(1) Press the menu [Device select].

(2) Select the device.

(3) Press the menu [File name].

(4) Select a file.

<When inputting the file name from the input area>

Input the file name.

10013 [INPUT]



The selected file name appears.

|       |            |
|-------|------------|
| A:Dev | USB Memory |
| Dir:  | /PRG/PRECU |
| File  | 10013.PRG  |
| -     |            |

<When selecting the file name from the list>

Press the menu [From list].



The cursor appears in the list.

| <Program> | <Char>                | <Comment> |
|-----------|-----------------------|-----------|
| .         | DIR                   |           |
| ..        | DIR                   |           |
| 10011.PRG | 240 Jun 08 13:13 2015 |           |
| 10012.PRG | 67 Mar 02 10:45 2012  |           |
| 10013.PRG | 100 Jun 08 16:12 2015 |           |
| 10014.PRG | 96 Jun 21 18:35 2012  |           |
| 10015.PRG | 48 Apr 02 11:11 2015  |           |

(5) Move the cursor to directory and file name to be selected, and set.

[↑], [↓] [INPUT]

This operation is repeated until the cursor reaches the file. When only the directory is selected and key is pressed, select the file name separately.

(6) Press the [INPUT] key.



The selected file name appears.

|       |            |
|-------|------------|
| A:Dev | USB Memory |
| Dir:  | /PRG/PRECU |
| File  | 10013.PRG  |
| -     |            |

**Canceling the input mode**

(1) Press the [Device Select], [Dir] or [File name].

(2) Press the  key or the  key.

**Changing or clearing the predefined file name**

Using the menu [File name in] or [Clear filename] enables you to rename or clear the file name easily, which has already been set in "A:Dev." or "B:Dev".

**■ Changing a part of the predefined file name**

(1) Select the device to rename the file, and press the menu [File name].

(2) Press the menu [File name in].



The file name of the selected device is imported to the input area.

(3) Change the file name by using [→], [←], or [DELETE] key.

(4) Press the [INPUT] key.

**■ Clearing the predefined file name**

(1) Select the device to clear the file name, and press the menu [File name].

(2) Press the menu [Clear filename].



The file name is deleted.

## 12.2 Transferring a File



### Operation method

- (1) Press the menu [Area change] to select file setting column A.
- (2) Designate the transfer source device, directory and file name.
 



The designated file appears.  
Multiple files can be designated in the file setting column A. Designate the first and last file name of the target range. A wildcard "\*" can be designated for the file name.
- (3) Press the menu [Area change] to select file setting column B.
- (4) Designate the transfer destination device, directory and file name.
- (5) Press the menu [Trnsfr A→B].
- (6) Press the [Y] or [INPUT] key.



### CAUTION



" ; ", "EOB", "%", and "EOR" are symbols used for explanation. The actual codes for ISO are "CR, LF" ("LF") and "%". "%" and "EOR" are represented by "%" in ISO. The programs created on the edit screen are stored in the NC memory in a "CR, LF" format, however, the programs created with external devices may be stored in an "LF" format. The actual codes for EIA are "EOB (End of Block)" and "EOR (End of Record)".



To prevent influence from data omission and data transformation in the communication circuit, always verify the data after inputting and outputting machining programs.

## Precautions

### ■Notes related to transferring in general

- (1) Depending on the type of file, some data cannot be transferred during automatic operation. Do not transfer during automatic operation.
- (2) When the capacity of the transfer destination is reached during file transfer, only the data transferred up to that point is registered as a file, and an error will occur.
- (3) During input to the NC memory or comparison, if the file format size on the NC memory side differs from the other side file format size (when the maximum number of registrations differs between the NC memory and the other side), processing is carried out matched to the smaller size.  
(Example 1) If a format size of 200 files is input for a format size of 1000 NC files, 200 files are registered.  
(Example 2) If 1000 files are input to the NC that formatted for 200 files, the files up to the 200th file can be registered and an error message appears. (The remaining files are not registered.)
- (4) Do not perform any file operation on the transfer source and destination files during the file transfer. The file may be damaged with the file operation.

### ■Notes when transferring machining program files

- (1) For the serial, always set both ends of the "EOR" code at the head and end to feed (Null). If "EOB" etc., is directly after "EOR", the operation may not execute normally due to the input buffer influence during the next input operation.
- (2) The transfer speed is slower if there are many registrations.
- (3) The size of one block of the machining program should be 250 characters or less.
- (4) The characters that can be used for the file name and directory path are 1-byte number, 1-byte capital alphabetical letters, and 1-byte symbols recognized by the system.  
Note that the following characters cannot be used.  
|, /, :, ", " (comma), \*, ?, ", <, >, a to z (small letters), space  
Up to 32 characters are allowed for the file name to create in or transfer to NC memory.
- (5) If the file whose name includes lower case alphabet is transferred to NC memory, the lower case letter will be converted into the capital letter.
- (6) When using tape, carry out parity V adjustment to improve the reliability of the tape format. Then use with the parameter "Parity V" validated.
- (7) When the MTB macro and fixed cycle program are input to NC memory, change the program type with the parameter "#1166 fixpro". Also, set in the Input/Output screen as follows:  
Device: Memory, Directory: Program
- (8) Transferring or verifying the multiple files between the external device connected serially and that other than the serial connection.
- (9) With machining program created before the MELDAS500 Series, "EOB" is registered as "LF". However, "EOB" will be converted to "CR LF", and the number of characters will increase in this Series. Thus, when all of the machining programs output from an MELDAS500 Series or earlier NC, having the same specifications as the maximum memory capacity, are stored in this Series, the memory capacity may be exceeded.
- (10) When the file to be transferred (input) is running or in "program restarting" mode, "program checking", the operation message "Executing automatic operation" or "Program restarting" or "Program checking" is displayed and file will not be transferred (input).
- (11) If the file to be transferred (input) is being edited on the custom screen, the operation message "Can't write into being edited file" appears and may not be transferred (input).
- (12) When the parameter "#8936 Delete leading 0" is set to "1", the file consisting only of numerical figures will be transferred with the "0" at the head deleted. For details, refer to "5.8.6 Leading Zero".
- (13) When the multi-part system program management is valid (#1285 ext21/bit0 =1) and "#1285 ext21/bit2" (Multi-part system program generation and operation) is set to "0", a machining program's transfer to the NC memory from the device other than the NC memory is executed across all part systems in batch. When it is set to "1", only displayed part system's machining program will be transferred.
- (14) When the multi-part system program management is valid (#1285 ext21/bit0 =1) and "#1286 ext22/bit5" (Selection of multi-part system program input/output method) is set to "0", the machining program's transfer from the NC memory to the device other than the NC memory will be executed across all part systems in batch. When it is set to "1", only displayed part system's machining program will be transferred.

- (15) The transfer range from the external device other than serial to NC memory will change depending on the value set in the parameter "#19006 EOR Disable".
- <When the parameter "#19006 EOR disable" is set to "0">  
The head line will not be transferred.  
Up to "%" in the second line onward will be transferred, and data after "%" will not be transferred.  
If there is no "%", all data will be transferred.
- <When the parameter "#19006 EOR disable" is set to "1">  
All file contents will be transferred.
- (16) If the file to be transferred (input) is targeted for edit lock (edit lock B: 8000 to 9999 or edit lock C: 9000 to 9999), the message "Edit lock B" or "Edit lock C" is displayed, causing a transfer failure.  
If the program name is input with only numbers when the parameter "#8936 Delete leading 0" is set to "1", the program is checked with the leading zero deleted. (Example: If the file name to be transferred (input) is designated by "008000" while edit lock B is enabled, the message "Edit lock B" is displayed, causing a transfer failure.)
- (17) Multiple successive files or wildcard (\*), if designated, is transferred, excluding the programs to be edit-locked, to suit the status of edit lock B or C.
- (18) If the device shown below and the directory are designated for the destination to transfer a file, the following operation is performed depending on conditions.
- When an existing file is designated: The file is transferred with a temporary file name, and changed to the designated file name after transfer processing has been completed.
  - When a new file is designated: A new file is transferred with a temporary file name, and changed to the designated file name after transfer processing has been completed.
- (1) [B:Dev]: Memory  
Directory: Machining program
- (2) [B:Dev]: DS, memory card, USB memory (\*1)
- A temporary file is designated by the file name that consists of 11 digits, beginning with the symbol "~".
- After transfer is terminated properly, the temporary file is changed to the designated file name.  
A temporary file remains in the cases below, but can be deleted in the same way as for a normal file.
- When the transfer has terminated abnormally, for example, because the destination's capacity became full.
  - When the transfer has been interrupted.
- (\*1) Memory card and USB memory support the following models:
- M800S
  - M80
  - E80
  - Non-Windows-based display unit of M800W
  - Non-Windows-based display unit of M80W

#### ■Notes when transferring tool offset data files

- (1) If an error occurs during offset data transfer, an error message appears on the screen, and the transfer operation is interrupted.
- (2) Tool offset data file cannot be transferred from the serial to the memory.

#### ■Notes when transferring parameter files

- (1) In the same manner as when setting in the Parameter screen, there are parameters validated immediately after input, and parameters validated after a restart. Restart when a parameter file has been transferred to the NC memory.
- (2) When a parameter file is transferred to the NC memory, the setting value of the input/output parameters is also changed. Before transferring next time, set the parameters again.
- (3) When a protected parameter file (user parameter, machine parameter or pitch error compensation amount is protected) is transferred to NC memory, the message "Transfer skipping protected data?(Y/N)" appears. Pressing the [Y] key enables you to input the parameters except for protected data. If all parameters are protected, the message "Data protect" appears, no parameter can be input.
- (4) When a protected parameter file (user parameter, machine parameter or pitch error compensation amount is protected) is transferred to an external device from NC memory, the message "Data protect" appears and the parameter cannot be output.

**■Notes when transferring common variable data files**

- (1) If the variable value is 100000 or more or less than 0.0001 when transferring common variable data, it is expressed with an exponential expression.
- (2) When the common variable protection is set with the parameter #12111 to #12114, the message "Transfer skipping protected data?(Y/N)" appears. Pressing [Y] skips the protected variables, so they are not written to NC memory.
- (3) When common variable protection is set with the parameter #12111 to #12114, the protected variables are not written to NC memory, even if the part system-based common variables included in the common variable data file are handled as the variables common to part systems by the NC.

**■Notes when transferring all tool data files**

- (1) When tool life data is output from the NC memory, the tool information data, tool compensation data, and custom data allocation information are output per section.  
Tool information data section: [TOOLINF\_L1] (Tool life management I), [TOOLINF\_L2] (Tool life management II), [TOOLINF\_M] (Tool life management M system)  
Tool compensation data section: [TOOLOFS]  
Custom data allocation section: [CUSTOM]
- (2) When all tool data is transferred to NC memory with either tool data or workpiece shift data protected, the message "Transfer skipping protected data?(Y/N)" appears. Pressing the [Y] key allows you to transfer the data with the protected data skipped. If both data are protected, the message "Data protect" appears and no data can be input.
- (3) When all tool data is transferred to an external device from NC memory with either tool data or workpiece shift data protected, the message "Data protect" appears and the data cannot be output.

**■Notes when transferring sampling data file**

- (1) When the output form is set as 8-digit hexadecimal number and the parameter "#1004 ctrlunit" is set to "E (1nm)", accurate data can be output just within 1 m. When the output data length exceeds 1 m, lower 32 bits of the sampling data will be output.
- (2) Sampling data file can be transferred from NC memory to an external device (output) but cannot be transferred from an external device to NC memory (input).

**■Notes when transferring workpiece offset data files**

- (1) Tool offset data file cannot be transferred from the serial to the memory.

**■Notes when transferring machining surface data file**

- (1) If you attempt to transfer (input) the data while a machining surface is selected in the machining surface selection screen, the error message "Can't write file for dev B" appears. In that case, cancel the selection of the machining surface.

**■Notes when transferring spatial error data file (POSTURE.DAT)**

- (1) The spatial error data can be transferred from an external device to NC memory (input) but cannot be transferred from NC memory to an external device (output).

**■Notes when transferring email transmission log file**

- (1) Log file can be transferred from NC memory to an external device (output) but cannot be transferred from an external device to NC memory (input).

**■Notes when transferring teach data file**

- (1) When the teach data file is protected, the message "Data protect" appears and the data cannot be input or output.

## 12.3 Comparing Files (Compare)



### Operation method

- (1) Press the menu [Area change] to select file setting column A.
- (2) Designate the device, directory and file name to be compared.
- (3) Press the menu [Area change] to select file setting column B.
- (4) Designate the other device, directory and file name to be compared.
- (5) Press the menu [Compare A:B].

➔ The file comparison starts.  
 The verifying data is displayed.  
 A message appears when the comparison is completed.  
 If a comparison error occurs, the block with the error is displayed in the comparison data display column on the screen.

```
INP data: (MAIN);G28XYZ;G00X10.;N1X20.
 ;X30.;X40.;N2X50.;M98P102H1;
CMP data: (MAIN);G28XYZ;G00X10.;N1X20.
 ;X30.;X40.;N2X50.;M98P103H1;
```

### Note

- (1) Files that can be compared are text files only. Correct outcome will not be obtained through binary file comparison.
- (2) Designating "\*" for the compared file name causes "Setting error" when the comparison is executed with serial. Designate no file name or designate a target file name.
- (3) "0" at the head of the file name will not be deleted when checking the individual file which consists of one program in one file even the parameter "#8936 Delete leading 0" is set to "1". Designating the file name is required. However, in the case of serial/batch file, comparison is carried out with a leading zero in the program name deleted.
- (4) When multiple successive files or wildcard (\*) are/is designated as the transfer source, the comparison is executed excluding the programs which are subject to the edit lock according to the status of Edit lock B and C.
- (5) If you attempt the file comparison during the tool data sorting, the operation message "Can't open file for dev A (or B)" appears, which disables the comparison.



## 12.4 Erasing a File



### Operation method (Erasing a file in file setting column A)

- (1) Press the menu [Area change] to select file setting column A.
- (2) Designate the device, directory and file name to be erased.
- (3) Press the menu [Erase A].
- (4) Press the [Y] or [INPUT] key.

➡ The file is erased.  
 A message appears when the erasing is completed.  
 The number of programs registered, number of memory characters and remainder reappear.  
 Press the menu [List update] to update the list.

### Note

- (1) If the file to be erased is running or in "program restarting" mode, the operation message "Executing automatic operation" or "Program restarting" is displayed, and the file will not be erased.
- (2) If the file to be erased is being edited on the custom screen, the operation message "Can't erase designated file" appears and may not be erased.
- (3) When a wildcard "\*" is designated for the file to be erased, the erasing is executed excluding the programs which are subject to the edit lock according to the status of Edit lock B and C.

### Operation method (Erasing a file in file setting column B)

The operations are the same as method "Erasing a file [Erase A]" above. Designate the target device, directory and file name in the file setting column B, and press the menu [Erase B].

## 12.5 Changing a File Name (Rename)



### Operation method

- (1) Press the menu [Area change] to select file setting column A.
- (2) Designate the original device, directory and file name.
- (3) Press the menu [Area change] to select file setting column B.
- (4) Designate the new device, directory and file name.
- (5) Press the menu [Rename A→B].
- (6) Press the [Y] or [INPUT] key.

### Note

- (1) Make sure the original and new devices are the same.
- (2) If the file to be renamed is running or in "program restarting" mode, the operation message "Executing automatic operation" or "Program restarting" is displayed, and the name will not be changed.
- (3) If the file to be renamed is being edited on the custom screen, the operation message "Can't rename designated file" appears and may not be changed.
- (4) If a file that does not exist is designated for the original file, or if an existing file name is designated for the new file selection, an error occurs, and the name is not changed.
- (5) The directory where the file in operation search/check search is stored cannot be renamed. The operation message "Can't rename designated file" appears.

## 12.6 Creating a Directory



### Operation method

- (1) Press the menu [Area change] to select the file setting column A.
- (2) Designate the device.
- (3) Designate the directory where the new directory is to be created.
- (4) Set the new directory in the file setting column A.
- (5) Press the menu [Dir create].



The designated details appear.

The devices that can create a directory are HD, memory card, DS, and USB memory.

The directory can also be created in file setting column B.

## 12.7 Restrictions

- (1) For Ethernet input-output, you can insert only one LAN card into the PC side. If multiple LAN cards are inserted simultaneously, no operations are assured.
- (2) When multiple files are transferred to NC memory, a file in edit lock mode is not transferred, and other files are transferred.

### 12.7.1 Device Definition

- (1) Removable disks in drive E and after are used as memory card devices. (Drive name advanced by the value of "#1390 BackUSBUseNum" from drive E. (Example: When #1390: 2, drive G is set as the drive name.)(\*1)
- (2) Removable disks in drive F and after are used as USB memory devices. (Drive name advanced by the value of "#1390(BackUSBUseNum)" from drive F. (Example: When #1390 :2, drive H is set as the drive name.)(\*1)
- (3) If a USB memory device formatted over FAT32 is used, it may cause a file reading and writing failure. Use a USB memory device that is formatted with FAT32.
- (4) If a USB memory device is removed or inserted while data is being transferred to it, data integrity cannot be guaranteed. While message "Now, transferring data" or "Now, formatting data" is being displayed, do not remove or insert the USB memory device. After message "Transfer completed" or "Formatting completed" has been displayed, remove or insert the USB memory device.

(\*1) Targeted only for the M800W/M80W Series.

### 12.7.2 List Display

- (1) If the number of full path characters exceeds 128 when the directory is being moved, it results in a movement failure.
- (2) In the NC memory, you cannot use the cursor movement key or [INPUT] key to move the directory.
- (3) The file name and directory name must be designated using less than 64 characters. If the file name or directory name is designated using 64 or more characters, it may not be recognized as the file name or directory name.
- (4) If a directory that contains a double-byte code file name such as a Japanese file name is displayed in list view, such a double-byte code file name is not displayed correctly. In addition, the number of file characters, comments, and number of stored characters is not displayed correctly.

### 12.7.3 Program Name

The following restrictions are applied to the file name that can be created and transferred in NC memory.

- (1) The file name must be designated using up to 32 characters, including an extension.
- (2) Single-byte digits, single-byte uppercase alphabet characters, and Windows-recognizable single-byte symbols are available for the file name or directory name. Therefore, a double-byte code file name such as a Japanese file name cannot be used.
- (3) Edit lock B, edit lock C, and program display lock are available only for files that have the file name designated only by single-byte digits in the NC memory.

Example: When edit lock B (8000 to 9999) is enabled:

| File name | Feature                                     | Change   |
|-----------|---------------------------------------------|----------|
| 8000      | Single-byte digits only                     | Disabled |
| 8000.PRG  | With extension                              | Enabled  |
| 08000     | Single-byte digits only, beginning with "0" | Enabled  |
| 8000A     | With characters other than digits           | Enabled  |

- (4) The following names cannot be used as file names.
  - ♦File name with extension "\$\$\$", "\$\$0", "\$\$1", "\$\$2", "\$\$3", "\$\$4", "\$\$5", "\$\$6", "\$\$7", "\$\$8", or "\$\$9"
  - ♦"0" (File named "single-byte zero")

#### 12.7.4 ALL.PRM Input

- (1) ALL.PRM data is assumed as a comment by adding a semicolon (;) at the head of the data, and it can be excluded from being input. However, the message "Compare error" appears when it is compared.
- (2) When ALL.PRM data which has header information (output date, CNC name, unit name, serial number and NC system information) is input to the older version device, the operation message "Can't write file for dev B" appears.
- (3) Output format can be changed with the parameter "1218 aux02/bit3" (Parameter input/output format), but the format of header information is unchanged.
- (4) When the parameter files (ALL.PRM) output from NC memory to the device (HD, DS or USB memory etc.) are compared, the message "Compare error" appears because of the discrepancy of the header information.

## 12.8 Other Functions

### 12.8.1 Merging a File



#### Operation method

- (1) Press the menu [Area change] to select file setting column A.
- (2) Designate the merge destination device, directory, and file name.
- (3) Press the menu [Area change] to select file setting column B.
- (4) Designate the merge source device, directory, and file name.
- (5) Press the menu [Merg B→A].
- (6) Press the [Y] or [INPUT] key.

➔ A message appears when the merge is completed. The details of the file in file setting column A will be as follows when the merge is completed.

|                                                                                                           |                                                                                                                                 |
|-----------------------------------------------------------------------------------------------------------|---------------------------------------------------------------------------------------------------------------------------------|
| <pre>(FILE A) G28 XYZ G90 F800 G00 X100. Y100.; (FILE B) G91 G28 XYZ F1000; G01 X200. Y200.; M02; %</pre> | <p>} Details of file in file setting column A before merge.</p> <p>} Details of file in file setting column B before merge.</p> |
|-----------------------------------------------------------------------------------------------------------|---------------------------------------------------------------------------------------------------------------------------------|

The details of the file in file setting column B do not change.

#### Note

- (1) If the merge destination file (file in file setting column A) is running or in "program restarting" mode, the operation message "Executing automatic operation" or "Program restarting" is displayed, and the files will not be merged.
- (2) If the merge destination file (file in file setting column A) is being edited on the custom screen, the operation message "Can't write into being edited file" appears and may not be merged.
- (3) When the parameter "#19006 EOR Disable" is set to "1", a file is merged as it is. But the terminal character of the merge destination file (file in file setting column A) is "%", a line feed code is added and then merged.
- (4) The devices that can be merged are the memory, HD, memory card, DS and USB memory.
- (5) Do not perform the file operation on the merge source and destination files during the merge. The file may be damaged with the file operation.

## 12.8.2 List of File Names

There is a directory for each type of data in the device [Memory].

Each directory and file name (fixed) in the device is shown below.

Do not change the extensions (.XXX) when storing in a device other than [Memory].

| Data type                                                                                                                                                                                                                                                                                                                                                                                                                                                                                                | NC memory directory path | Fixed file name                                                                                                                                                                                                                                          |
|----------------------------------------------------------------------------------------------------------------------------------------------------------------------------------------------------------------------------------------------------------------------------------------------------------------------------------------------------------------------------------------------------------------------------------------------------------------------------------------------------------|--------------------------|----------------------------------------------------------------------------------------------------------------------------------------------------------------------------------------------------------------------------------------------------------|
| Machining program                                                                                                                                                                                                                                                                                                                                                                                                                                                                                        | /PRG/USER                | (Program No.)                                                                                                                                                                                                                                            |
| Fixed cycle program                                                                                                                                                                                                                                                                                                                                                                                                                                                                                      | /PRG/FIX                 | (Program No.)                                                                                                                                                                                                                                            |
| MTB macro                                                                                                                                                                                                                                                                                                                                                                                                                                                                                                | /PRG/MMACRO              | (Program No.)                                                                                                                                                                                                                                            |
| User macro                                                                                                                                                                                                                                                                                                                                                                                                                                                                                               | /PRG/UMACRO              | (Program No.)                                                                                                                                                                                                                                            |
| Parameters<br>Parameters [User, machine] (Text format)<br>DeviceNet<br>Safety parameter file                                                                                                                                                                                                                                                                                                                                                                                                             | /PRM                     | ALL.PRM<br>DEVICENT.PRM<br>SAFEPARA.BIN                                                                                                                                                                                                                  |
| PLC program<br>PLC program file for each project<br><br>Own station safety PLC program file<br>Other station safety PLC program file                                                                                                                                                                                                                                                                                                                                                                     | /LAD                     | PROJECTxx.LAD<br>(xx: 01 to Usable project No.)<br>SAFEPLC1.LAD<br>SAFEPLC2.LAD                                                                                                                                                                          |
| NC data<br>Tool compensation amount data<br>All tool data<br>Common variable data<br>SRAM data<br>SRAM data (non-Windows-based display unit) (*1)<br>Workpiece offset data<br>Option file<br>Workpiece installation error compensation data<br>SRAM open data<br>Device open data<br>Machining surface data<br>Spatial error data file (text format)<br>Spatial error data file (binary format)<br>Interference data<br>Email transmission setting file<br>Email transmission address file<br>Teach data | /DAT                     | TOOL.OFS<br>TOOLALL.DAT<br>COMMON.VAR<br>SRAM.BIN<br>SRAMSCRN.BIN<br><br>WORK.OFS<br>OPTION-ADD.OPT<br>WKPOS.OFS<br>SRAMOPEN.DAT<br>DEVOPEN.DAT<br>RNAVI.DAT<br>POSTURE.DAT<br>POSTURE.BIN<br>OBSTACL.DAT<br>MAILSET.DAT<br>MAILADDR.DAT<br>TEACHPOS.DAT |
| System configuration data                                                                                                                                                                                                                                                                                                                                                                                                                                                                                | /DGN                     | ASSEMBLY.INF                                                                                                                                                                                                                                             |
| Decryption code                                                                                                                                                                                                                                                                                                                                                                                                                                                                                          | /RLS                     | PASSCODE.DAT                                                                                                                                                                                                                                             |
| Sampling data (binary)<br>Email transmission log file<br>History data<br>All history<br>Key history<br>Alarm history<br>Touch history                                                                                                                                                                                                                                                                                                                                                                    | /LOG                     | NCSAMP.CSV<br>MAILSENDxx.LOGN (xx :1 to 10)<br>NCSAMP.BIN<br>ALLLOG.LOG<br>KEYLOG.LOG<br>ALMLOG.LOG<br>TOUCHLOG.LOG                                                                                                                                      |

(\*1) Supported with non-Windows-based display unit of M800W/M80W Series

## 12.8.3 Edit Lock B and C

This function prohibits editing, erasing, etc., of the machining programs B and C, and protects the machining programs in the device [Memory].

| Machining program                            | Edit Lock B        | Edit Lock C        |
|----------------------------------------------|--------------------|--------------------|
| A<br>1 to 7999<br>10000 to 99999999          | ---                | ---                |
| B<br>(user standard program)<br>8000 to 8999 | Editing prohibited | ---                |
| C<br>(MTB custom)<br>9000 to 9999            | Editing prohibited | Editing prohibited |

The operations below in the Edit MDI and the Input/Output screens are influenced by the edit lock setting.

An error will occur if operations that are not possible are attempted.

When the edit lock is valid, processing is executed (except the edit lock target program) by the input/output function.

○: Operation possible      ×: Operation not possible

| Screen       | Operation         | Edit Lock B       |   |   | Edit Lock C       |   |   |
|--------------|-------------------|-------------------|---|---|-------------------|---|---|
|              |                   | Machining program |   |   | Machining program |   |   |
|              |                   | A                 | B | C | A                 | B | C |
| Edit         | Search            | ○                 | ○ | × | ○                 | ○ | × |
|              | Edit              | ○                 | × | × | ○                 | ○ | × |
|              | MDI registration  | ○                 | × | × | ○                 | ○ | × |
| Input/Output | Transfer          | ○                 | × | × | ○                 | ○ | × |
|              | Compare           | ○                 | × | × | ○                 | ○ | × |
|              | Copy              | ○                 | × | × | ○                 | ○ | × |
|              | Merge             | ○                 | × | × | ○                 | ○ | × |
|              | Rename            | ○                 | × | × | ○                 | ○ | × |
|              | Erase             | ○                 | × | × | ○                 | ○ | × |
| Monitor      | Buffer correction | ○                 | × | × | ○                 | ○ | × |

### Note

- (1) When the multiple part system specification is valid, the machining programs of all the part systems are protected by edit lock B and C.
- (2) When multiple serial files or a wildcard (\*) is designated for input/output function, programs except subject to edit lock will be processed.
- (3) When a multiple programs are input to the memory without designating the file name like serial input or program batch input, the message "Edit lock B" or "Edit lock C" appears and the input is interrupted if the program which is subject to edit lock is detected.
- (4) A machining program in the USB memory is assumed as machining program A whatever its file name is, it is not subject to the protection of Edit Lock B or C.



### 12.8.4 Data Protection Keys

Data protection key prevents various data from being set or erased.  
 The key name differs according to the MTB. Refer to the instruction manual issued by the MTB for details.

The following data can be protected with the data protection key:

- All tool data and the coordinate system preset data using the origin set
- User parameters and common variables
- Machining programs
- Files in the memory card
- Files in the DS

The data protection key is enabled to prohibit the setting, erasing, etc. while the PLC signal is OFF (B contact).  
 Data protection key has higher protection level than that of Data protection by user's level.

### 12.8.5 The Batch Input/Output the Machining Program of NC Memory



One file which consists of two or more machining program can be transferred to NC memory by dividing the file. The machining programs united with one file can be transferred to the external device.

The targets are the machining programs of the user.

#### Batch input and verify to NC memory

Example of "the external device -> NC memory" of machining program batch transfer

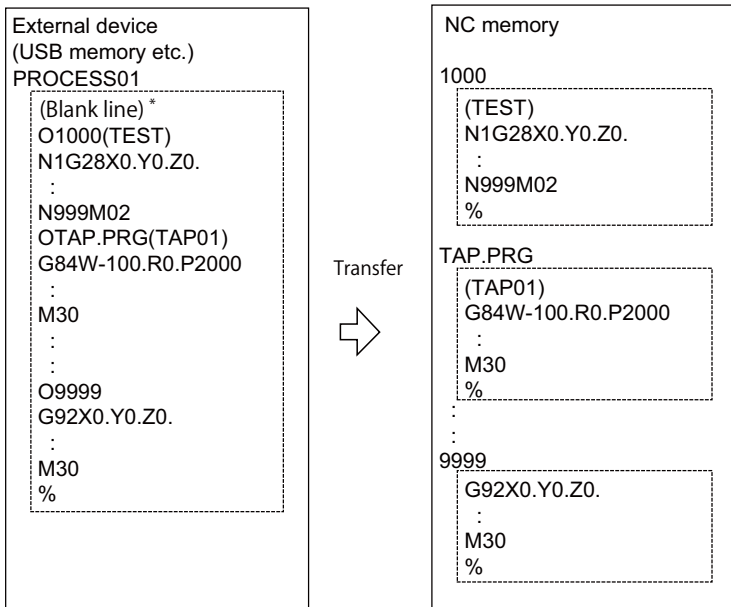

When the external device is serial, the top line is %.

When the transfer direction file name is designated, the top program name of transfer source can be omitted. ("O1000" can be omitted in above example.)

- (1) Press the menu [Area change] to select file setting column A.
- (2) Designate the transfer source device and directory.
- (3) Designate the file which consists of two or more machining programs.
- (4) Press the menu [Area change] to select file setting column B.
- (5) Designate the transfer direction device (memory).
- (6) Press the menu [Dir] - [Program all].  
When the file name is designated, only the top program of transfer source is stored in the designated file.  
For example of "Example of "the external device -> NC memory" of machining program batch transfer", when "TEST-CUT" is designated as the transfer direction file name, the top program is transferred as not "1000" but "TESTCUT".
- (7) Press the menu [Trnsfr A→B].
- (8) Press the [Y] or [INPUT] key.  
When the same machining program already exists in transfer direction device, the operation message "Overwrite this file?(Y/N)" appears.  
The transferring the following program is continued by selecting [Y] or [N] key.
- (9) Press the menu [Compare A:B].

### Note

- (1) When programs are input in a batch to NC memory, always specify "Program batch" to NC memory directory as transfer direction. If "Program batch" is not specified, one file is transferred (No batch).
- (2) When the program which is subject to edit lock exists in transfer source, the message "Edit lock B" or "Edit lock C" appears, and transfer is interrupted. When the program which is not subject to edit lock is transferred, delete the program which is subject to edit lock in transfer source. (Refer to "12.8.3 Edit Lock B and C".)
- (3) When the protection of the machining program is valid, the program cannot be transferred/verified. (Refer to "12.8.4 Data Protection Keys".)
- (4) The program during automatic operation, program restart or program checking cannot be overwritten. The operation message "Executing automatic operation", "Program restarting" or "Program checking" appears, and transfer is interrupted.
- (5) If the transfer destination includes the file being edited on the custom screen, the operation message "Can't write into being edited file" appears and the transfer may be interrupted.
- (6) The first line of the transfer source file is ignored.
- (7) When the transfer source is serial, the program is similarly transferred even if direction of following case 1 and case 2 is set.

|             | Case 1                     | Case 2                     |
|-------------|----------------------------|----------------------------|
| Device name | Memory                     | Memory                     |
| Directory   | Program batch              | Program                    |
| File name   | (Null or file designation) | (Null or file designation) |

## Batch output and verify from NC memory

Example of "NC memory -> the external device" of machining program batch transfer

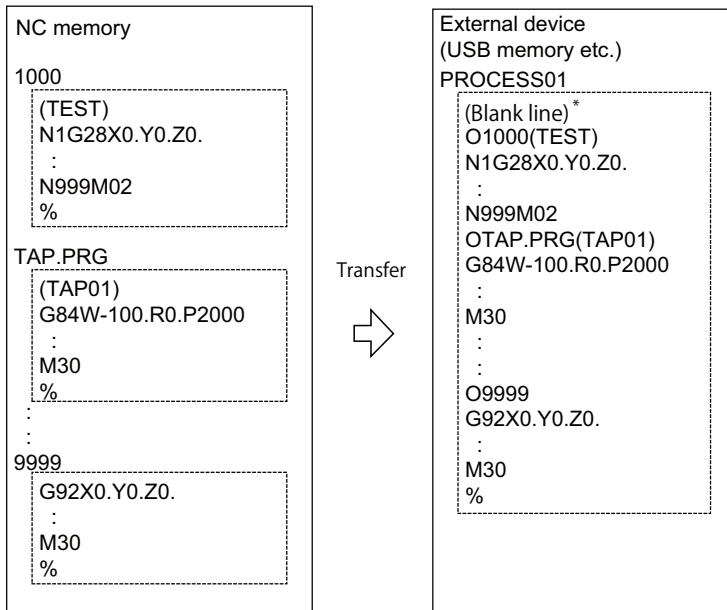

When the external device is serial, the top line is %.

- (1) Press the menu [Area change] to select file setting column A.
- (2) Designate the transfer source device (memory).
- (3) Press the menu [Dir] - [Program all].  
Do not specify the file name. If the name is specified, an error will occur.
- (4) Press the menu [Area change] to select file setting column B.
- (5) Designate the transfer direction device and directory.
- (6) Designate the transfer direction file to input multiple machining programs.  
When the file name is not designated, output to the file "ALL.PRG" of the designated directory.
- (7) Press the menu [Trnsfr A→B].
- (8) Press the [Y] or [INPUT] key.  
When the same machining program already exists in transfer direction device, the operation message "Overwrite this file?(Y/N)" appears.  
The transferring the following program is continued by selecting [Y] or [N] key.
- (9) Press the menu [Compare A:B].

**Note**

- (1) When programs are output in a batch from NC memory, always specify "Program batch" to NC memory directory as transfer source. If "Program batch" is not specified, the program is transferred by one program per one file.
- (2) When the programs which are subject to edit lock exists in NC memory, those file is not transferred. (The files are transferred excluding those files.) The verification is executed excluding the programs which are subject to edit lock. (Refer to "12.8.3 Edit Lock B and C".)
- (3) When the protection of the machining program is valid, the program cannot be transferred/verified. (Refer to "12.8.4 Data Protection Keys".)
- (4) When the transfer direction is serial, the program is similarly transferred even if source of following case 1 and case 2 is set.

|             | Case 1        | Case 2       |
|-------------|---------------|--------------|
| Device name | Memory        | Memory       |
| Directory   | Program batch | Program      |
| File name   | (Null)        | * (Wildcard) |



**Precautions**

- (1) When the machining program batch input/output function of NC memory is used, "(" cannot be used for the machining program name. It is recognized that the inside of "(" is a comment.
- (2) The file name of file which consists of two or more machining program can have up to 32 characters, including the extension as well as the machining program.
- (3) When the "Program batch" is designated to NC memory directory, it is not possible to delete, rename and merge files. When the files are deleted in a batch, use "Program" for directory, and a wildcard (\*) for file name.
- (4) For other precautions, refer to "12.2 Transferring a File".

## 12.8.6 Format Memory Card/DS/USB Memory

This section explains how to format the memory card (front-side SD card), DS (built-in SD card) and USB memory.

(Example) Formatting memory card

- (1) Press the menu [MemCrd format].  The message confirming the format "OK?(Y/N)" appears.
- (2) Press the [Y] or [INPUT] key.  The memory card is formatted. During format, the message "Executing format" appears and the message "Format complete" appears when the format is completed.

When formatting DS or USB memory, press the menu [DS format] or [USB Memformat] in the procedure (1).

**Note**

- (1) When the memory card, DS and USB card are less than 2GB, the format is executed with FAT16, and when they are 2GB to 32GB, format is executed with FAT32.  
When formatting the memory card, DS or USB memory which exceeds 32GB, the message "Format error" appears and the format cannot be executed.
- (2) The format cannot be executed during automatic operation.

## 12.9 Performing Batch Backups of NC Memory Data



The all backup screen of the maintenance (Mainte) screen is used to perform batch backups of the NC memory data to an external device. Also, the data can be restored from the external device to the NC memory in a batch.

Data backed up by the automatic backup function can also be restored.

Data which has been automatically backed up can be selected only when the device set by the "#8919 Auto backup device" parameter setting is selected.

This operation is protected according to the operation level.

The following devices are available in all backup and restoration:

|             |                                                                                                                                     |
|-------------|-------------------------------------------------------------------------------------------------------------------------------------|
| HD          | Hard disk (This is not displayed on M800S Series, M80 Series, E80 Series, and non-Windows-based display unit of M800W/M80W Series.) |
| Memory card | Front-side SD card                                                                                                                  |
| DS          | [M800S/M80/E80] Back-side SD card of the display unit<br>[M800W/M80W] Control unit-side SD card                                     |
| USB memory  | -                                                                                                                                   |

The master data backup and restoration are used for backing up and restoring the initial state data set by MTB. The built-in memory is used for the master data backup and restoration regardless of the selected device.

Files to be backed up/restored are as follows:

| Screen display    | File name            | Data type                                                               |
|-------------------|----------------------|-------------------------------------------------------------------------|
| System data       | SRAM.BIN             | SRAM data (binary files)<br>Programs, parameters, R registers and so on |
|                   | ALL.PRM (*1)         | Parameters                                                              |
|                   | ASSEMBLY.INF (*1)    | System configuration                                                    |
| Ladder            | USERPLC.LAD          | User PLC program                                                        |
|                   | EIPCONFDATA.BIN      | EtherNet/IP configuration file                                          |
|                   | PLCMMSG_XXX.TXT (*2) | PLC message file for MTB                                                |
|                   | PLCUMSG_XXX.TXT (*2) | PLC message file for users                                              |
|                   | MCRMMSG_XXX.TXT (*2) | Macro alarm message file                                                |
| Safety parameters | SAFEPARA.BIN         | Safety parameter (binary file)                                          |
| Safety ladder 1   | SAFEPLC1.LAD         | Safety PLC program 1                                                    |
| Safety ladder 2   | SAFEPLC2.LAD         | Safety PLC program 2                                                    |
| APLC data         | APLC.BIN             | C language module created by user                                       |
| Custom data       | -                    | Custom screen data                                                      |

(\*1) These data can be backed up only, cannot be restored.

(\*2) "XXX" indicates the abbreviation for each language.

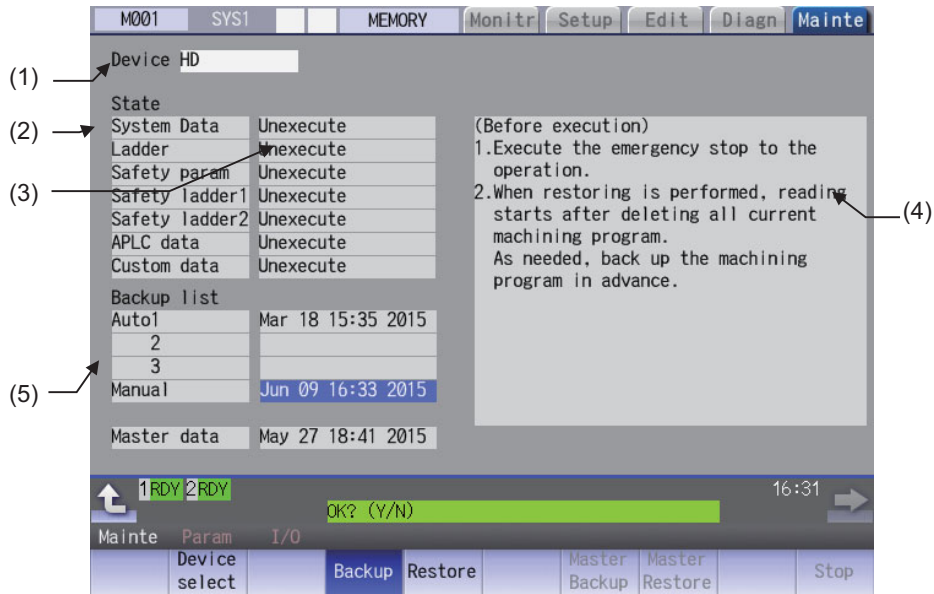

**Display items**

| Display items                 | Details                                                                                                                                                                                                                                                                                                                                                                                                                                                                                                                                                                                                                                                                                                                                                                                                                                                              |               |         |               |        |                                                                                                                                        |      |        |        |        |                                         |        |                               |                                                                                          |        |
|-------------------------------|----------------------------------------------------------------------------------------------------------------------------------------------------------------------------------------------------------------------------------------------------------------------------------------------------------------------------------------------------------------------------------------------------------------------------------------------------------------------------------------------------------------------------------------------------------------------------------------------------------------------------------------------------------------------------------------------------------------------------------------------------------------------------------------------------------------------------------------------------------------------|---------------|---------|---------------|--------|----------------------------------------------------------------------------------------------------------------------------------------|------|--------|--------|--------|-----------------------------------------|--------|-------------------------------|------------------------------------------------------------------------------------------|--------|
| (1) Device name               | This displays the selected device name.                                                                                                                                                                                                                                                                                                                                                                                                                                                                                                                                                                                                                                                                                                                                                                                                                              |               |         |               |        |                                                                                                                                        |      |        |        |        |                                         |        |                               |                                                                                          |        |
| (2) File name                 | This displays the file name being backed up/restored.<br>The following items are displayed starting from the top.<br>"System Data", "Ladder", "Safety param", "Safety ladder1", "Safety ladder2", "APLC data", "Custom data"                                                                                                                                                                                                                                                                                                                                                                                                                                                                                                                                                                                                                                         |               |         |               |        |                                                                                                                                        |      |        |        |        |                                         |        |                               |                                                                                          |        |
| (3) Execution status          | This displays the status being executed.<br>Processing is executed in the "System Data", "Ladder", "Safety param", "Safety ladder1", "Safety ladder2", and "APLC data" order. (*1)                                                                                                                                                                                                                                                                                                                                                                                                                                                                                                                                                                                                                                                                                   |               |         |               |        |                                                                                                                                        |      |        |        |        |                                         |        |                               |                                                                                          |        |
| (4) Warning message           | This displays messages at the start and end of backup/restore processing.                                                                                                                                                                                                                                                                                                                                                                                                                                                                                                                                                                                                                                                                                                                                                                                            |               |         |               |        |                                                                                                                                        |      |        |        |        |                                         |        |                               |                                                                                          |        |
| (5) Backup list               | This displays the backup date list.<br>This date is the time stamp of system data . <table border="1" style="width: 100%; margin-top: 10px;"> <thead> <tr> <th>Backup list</th> <th>Details</th> <th>Backup format</th> </tr> </thead> <tbody> <tr> <td>Auto 1</td> <td rowspan="3">Data that was automatically backed up.<br/>Display in the backup date descending order. The latest 3 generations of data are displayed.</td> <td rowspan="3">Auto</td> </tr> <tr> <td>Auto 2</td> </tr> <tr> <td>Auto 3</td> </tr> <tr> <td>Manual</td> <td>Data that was backed up on this screen.</td> <td>Manual</td> </tr> <tr> <td>Master data (internal memory)</td> <td>Data that was backed up on this screen.<br/>Generally, this is the factory settings data.</td> <td>Manual</td> </tr> </tbody> </table> The above data can be selected at restore processing. (*2) | Backup list   | Details | Backup format | Auto 1 | Data that was automatically backed up.<br>Display in the backup date descending order. The latest 3 generations of data are displayed. | Auto | Auto 2 | Auto 3 | Manual | Data that was backed up on this screen. | Manual | Master data (internal memory) | Data that was backed up on this screen.<br>Generally, this is the factory settings data. | Manual |
| Backup list                   | Details                                                                                                                                                                                                                                                                                                                                                                                                                                                                                                                                                                                                                                                                                                                                                                                                                                                              | Backup format |         |               |        |                                                                                                                                        |      |        |        |        |                                         |        |                               |                                                                                          |        |
| Auto 1                        | Data that was automatically backed up.<br>Display in the backup date descending order. The latest 3 generations of data are displayed.                                                                                                                                                                                                                                                                                                                                                                                                                                                                                                                                                                                                                                                                                                                               | Auto          |         |               |        |                                                                                                                                        |      |        |        |        |                                         |        |                               |                                                                                          |        |
| Auto 2                        |                                                                                                                                                                                                                                                                                                                                                                                                                                                                                                                                                                                                                                                                                                                                                                                                                                                                      |               |         |               |        |                                                                                                                                        |      |        |        |        |                                         |        |                               |                                                                                          |        |
| Auto 3                        |                                                                                                                                                                                                                                                                                                                                                                                                                                                                                                                                                                                                                                                                                                                                                                                                                                                                      |               |         |               |        |                                                                                                                                        |      |        |        |        |                                         |        |                               |                                                                                          |        |
| Manual                        | Data that was backed up on this screen.                                                                                                                                                                                                                                                                                                                                                                                                                                                                                                                                                                                                                                                                                                                                                                                                                              | Manual        |         |               |        |                                                                                                                                        |      |        |        |        |                                         |        |                               |                                                                                          |        |
| Master data (internal memory) | Data that was backed up on this screen.<br>Generally, this is the factory settings data.                                                                                                                                                                                                                                                                                                                                                                                                                                                                                                                                                                                                                                                                                                                                                                             | Manual        |         |               |        |                                                                                                                                        |      |        |        |        |                                         |        |                               |                                                                                          |        |

(\*1) APLC data cannot be backed up/restored if the APLC release specification is invalid.

(\*2) The "Auto 1" to "Auto 3" data is displayed when the device set by the parameter "#8919 Auto backup device" is selected.

**Menus**

| <b>Menus</b>   | <b>Details</b>                                     |
|----------------|----------------------------------------------------|
| Device select  | This displays the sub-menu for "Device" selection. |
| Backup         | This executes backup processing.                   |
| Restore        | This executes restore processing.                  |
| Master Backup  | This backs up NC data to the built-in memory.      |
| Master Restore | This restores NC data to the built-in memory.      |
| Stop           | This stops processing.                             |

## 12.9.1 All Backup

This section explains the procedures to back up NC data in a memory card in a batch.

**Note**

(1) APLC data can be backed up only when the APLC release specification is valid.

**Operation method**

(1) Press the menu [Backup].



The all backup screen is displayed.

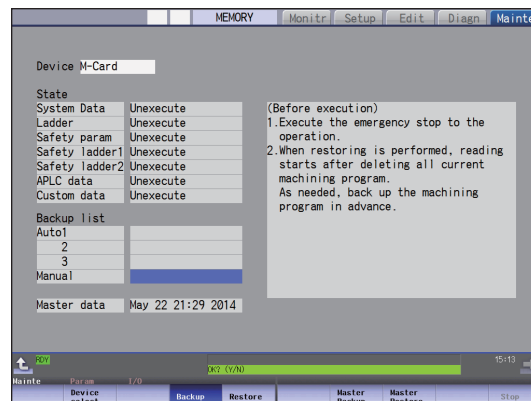

<Note>

◆ Press the  to cancel this process.

(2) Press the [Y], [y] or [INPUT] key.



The backup starts.

"Executing" and "\*" are displayed for the state of file under processing.

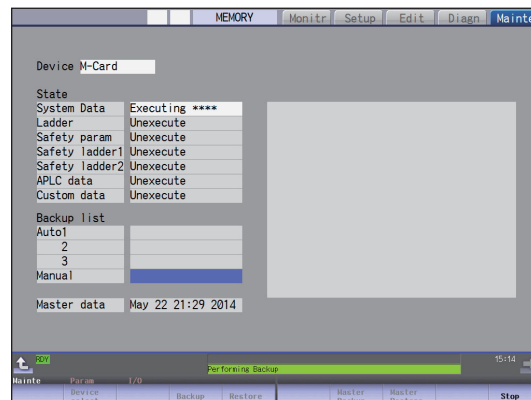

<Note>

- ◆ If any NC data file exists in the backup folder, the confirmation message "Overwrite this file?(Y/N)" appears. In this case, press the [Y], [y] or [INPUT] key to start backup.
- ◆ If the tool data is being sorted, the operation message "File access error" is displayed and the backup cannot be executed.
- ◆ For the custom data, the backup cannot be canceled during its execution.



(3) The backup is completed without error.



The states of backup-complete files turn to "Complete", the date displayed in "Backup list" will be updated.

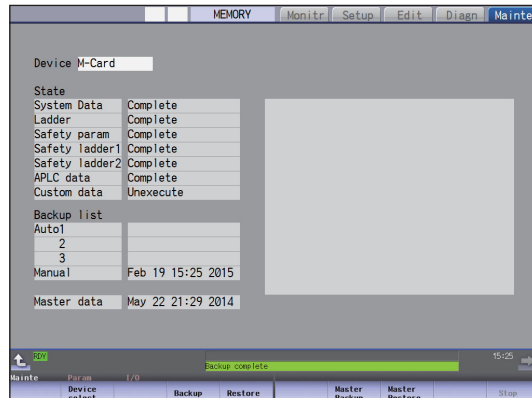

<Note>

- ◆ If the APLC release specification is invalid, the APLC data cannot be backed up and "Unexecute" is displayed.

## Note

- If an error occurs during the backup execution, the display is as follows:
  - Operation message: "File access error"
  - Execution state: "Error" for the file on which an error has occurred
  - Selected area: Clear
- Even when the data protection key (for memory card or SD) is valid, the data can be backed up in the memory card or DS.
- On the Windows-based display unit, if the size (the size in the actual memory) of custom data exceeds 48MB, the operation message "Skipped custom data due to over capacity" appears and the custom data cannot be backed up. Note that the size in the actual memory and the size on Windows may differ.

## 12.9.2 All Restoration

The following explains the procedure to restore the various NC data backed up to memory card in a batch.

The files which has been automatically backed up can be restored only when the device set by the parameter "#8919 Auto backup device" is selected.

### Note

- (1) The presence/absence of each file (system data, ladder, APLC data and custom data (for M80/E80 Series only)) for the transfer destination is not checked when the restoration is executed.
- (2) Each file for the system data, ladder, APLC data and custom data are rewritten when the restoration is executed.
- (3) In the following cases, an error message appears and the restoration is not executed.
  - ◆During the automatic operation
  - ◆One of the data protection key 1, 2 and 3 is valid.
  - ◆The NC serial number does not match the manufacturing number of the backup data.
  - ◆The "System data" file does not exist in the transfer source.
  - ◆The ladder larger than 256 KB is stored and all backup is executed when the large-capacity PLC specification is valid, and then the specification is switched to invalid.
- (4) APLC data can be restored only when the APLC release specification is valid.
- (5) When smart safety observation is valid, entering the safety password is required. If the safety password is not entered, the safety parameters and the safety ladders are cannot be restored. Operate from the procedure (3) when the smart safety observation is invalid.

### Operation method

- (1) Press the menu [Psswd input] on the maintenance (Mainte) screen.
- (2) Enter the safety password.
- (3) Set the device to memory card on the all backup screen. ➔ Memory card is selected as the restoration source device.
- (4) Press the menu [Restore]. ➔ The all restoration screen is displayed.

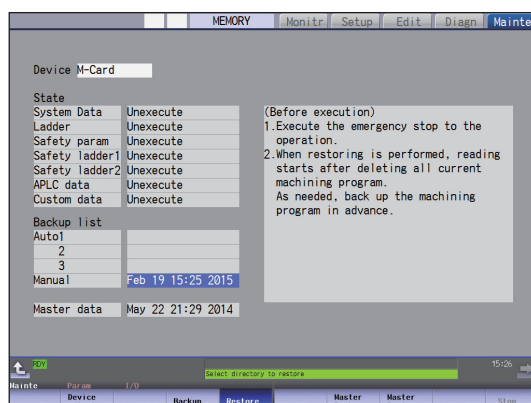

### <Note>

- ◆Press the  to cancel this process.
- ◆If the target device set for auto backup does not match the currently selected device, "Manual" is highlighted as the initial display position of the cursor.

- (5) Move the cursor to select the file. Press the [INPUT] key.

The cursor moves as follows:  
 [↓] key: Auto1 -> Auto2 -> Auto3 -> Manual -> Auto1  
 ...  
 [↑] key: Auto1 -> Manual -> Auto3 -> Auto2 -> Auto1  
 -> ...

The operation message "OK?(Y/N)" appears.

<Note>

- If there are no files at the position where the cursor moved to, the operation message "Select directory to restore" appears. Select the file again and then press the [INPUT] key.

- (6) Press the [Y], [y] or [INPUT] key.

The restoration starts.

"Executing" and "\*" are displayed for the state of file under processing.

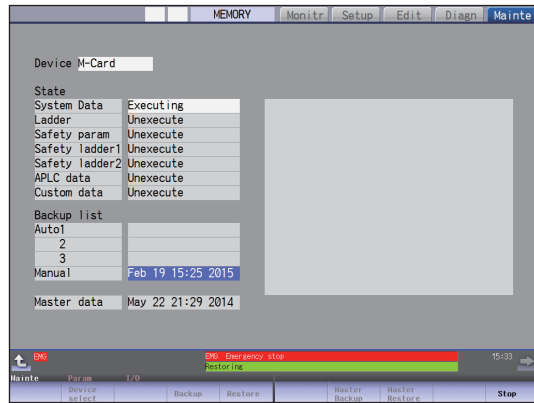

<Note>

- If PLC is in operation, the message "PLC running. Does it stop?(Y/N)" appears. Press the [Y], [y] or [INPUT] key to continue the restoration.
- If the tool data is being sorted, the operation message "File access error" is displayed and the restoration cannot be executed.
- For the custom data, the restoration cannot be canceled during its execution.

- (7) The restoration is completed without error.

The states of restoration-complete files turn to "Complete", the operation message "Restore complete" appears.

"Unexecute" is displayed for the file which could not be restored, for instance, due to the nonexistence of the file.

**Note**

- (1) When the restoration fails, perform the restoration again otherwise it may cause an abnormal operation.
- (2) Restored data writes over the previous absolute position data. Carry out the absolute position detection again after restoration.
- (3) If you attempt to restore custom data while custom data has already been installed, the Windows-based display unit shows the operation message "File access error", which may disable restoration. Use the integrated installer to delete the data from the NC before restoring custom data.

## Daily Maintenance

Some parts will not function in a hardware manner when the life is reached, so these should be replaced before the life is reached.

For details of the inspection and maintenance of the drive section, refer to the instruction manuals for each drive unit.

| Class                | Name                                                | Life                                           | Inspection/replacement                                                         |
|----------------------|-----------------------------------------------------|------------------------------------------------|--------------------------------------------------------------------------------|
| Daily Maintenance    | Touchscreen                                         |                                                | When needed<br>(when poor sensitive or dirty)                                  |
|                      | Escutcheon<br>(display unit area,<br>keyboard etc.) |                                                | Once/two months<br>(Accordingly when dirty)                                    |
| Periodic Maintenance | Battery<br>(lithium battery)                        | Cumulative data holding<br>time:<br>45,000 hrs | When battery voltage drop caution alarm occurs<br>(Guideline: approx. 5 years) |

### Note

- (1) Replace the battery within one month after the alarm "Z52 Battery fault 0001" appears on the NC screen.
- (2) The internal data may have been damaged if the alarm "Z52 Battery fault 0003" appears.

### Touchscreen



### CAUTION

**Always keep the touchscreen surface clean. When it gets dirty, remove the dirt immediately. Do not perform any operation on the dirty touchscreen.**

#### (1) Cleaning the touchscreen

- When metal powder or sand dust is on the touchscreen, remove it to prevent the scratches.
- Wipe the screen gently with a soft and clean cloth.

#### (2) Precautions for use

- The touchscreen may become poor sensitive, or even may not react when it gets dirty.
- Operate the touchscreen with fingers. The touchscreen does not react with nails.
- The use of gloves, work gloves, etc. will have effects such as the deterioration of the operation feeling depending on the material and thickness of the gloves.
- The polarizing plate (display surface) of the touchscreen surface can be easily scratched, so be careful during handling.
- Glass is used in the touchscreen. Be careful not to drop the touchscreen or allow it to hit hard objects, as the glass may chip or break.
- The polarizing plate may be stained or discolored if drops of water, etc., adhere to it for long periods, so be sure to wipe off any moisture immediately.
- Wipe off any dirt, dust, etc., on the polarizing plate using absorbent cotton or other soft cloth.
- Electronic parts are used in the touchscreen, so be careful of static electricity when handling.
- Never disassemble the Touchscreen. Doing so will damage the panel.

#### (3) Precautions for storage

- Do not store the card in locations having a high temperature or humidity. (Store within the storage temperature range.)
- When storing the touchscreen as an individual unit, be sure that other objects do not touch or hit the polarizing plate (display surface).
- When storing the touchscreen for long periods, be sure to store in a dark place away from exposure to direct sunlight or fluorescent light.

---

**Cleaning the escutcheon**

---

- (1) Prepare the rear side of the escutcheon to clean.
- (2) Wipe the escutcheon with a soft, clean, dry cloth. If cleaning is still required, put some neutral detergent on a cloth and wipe. Do not use alcohol, thinner, etc.



## Appendix 1: VNC Server Function



VNC server function enables status confirmation and remote operation by displaying the NC screen display on the external computer/tablet type computer.

In order to use this function, the unit needs to have an additional specification "VNC server function" and the parameter "#19701 Restrain VNCserver" needs to be set to "1" or "2".

## 14.1 Environment Establishment (Preparation)

The parameter needs to be set in order to connect to VNC client.

### Setting Ethernet parameters

Use the parameters #1953 to #1955. Set the same group IP address to "#1953 Intra IP address" as the external computer/tablet type computer in which VNC client is operated.

#### Note

- (1) For M80 Series, set the same values to the parameters "#1926 Global IP address" to "#1928 Global Gateway".
- (2) For M800S Series, you need to set the parameters "#1926 Global IP address" and "#1953 Intra IP address" to the IP address used in the same group. Set the same value to #1954 and #1955 as #1927 and #1928. When the different value is set, the connection cannot be made.

### Setting operation parameters

Set a password to #19702 VNC password.

Set a port No. to #19703 VNC server port.

Set "5901" as recommended value.

## 14.2 Displaying the NC Screen with VNC Client

Use "UltraVNC Viewer" as NC client.

### 14.2.1 Connecting VNC Client

- (1) Click "UltraVNC" - "UltraVNC Viewer" from the start menu to start VNC client.
- (2) Input the IP address of VNC server set in the parameter "#1953 Intra IP address" and the port No. set in "#19703 VNC server port" by connecting with ":", and click [Connect].

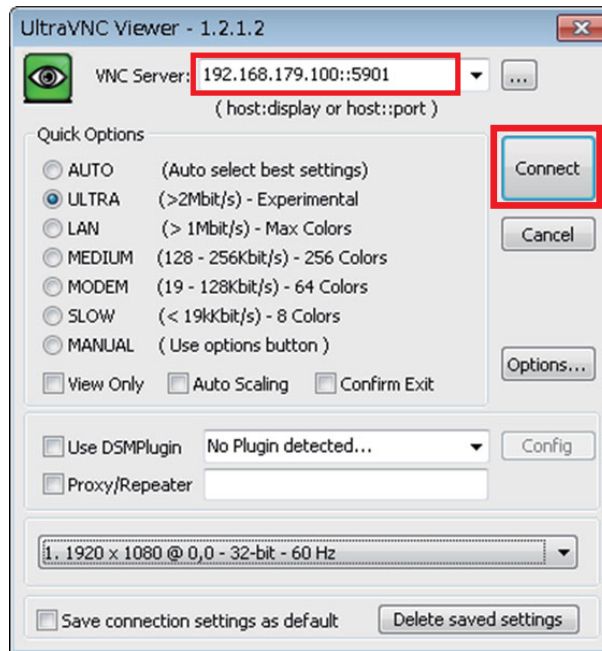

- (3) When the password input screen is displayed, input the password set in the parameter "#19702 VNC password" and then click [Log On].
- (4) VNC server is connected and NC screen is displayed.

The settings of "UltraVNC Viewer" are as follows.

| Display items                       |        | Details                                                                                                                                                                           |
|-------------------------------------|--------|-----------------------------------------------------------------------------------------------------------------------------------------------------------------------------------|
| Color depth setting                 | AUTO   | Set ULTRA to SLOW.                                                                                                                                                                |
|                                     | ULTRA  | Connect according to the setting of the parameter "#19704 VNC color depth". (recommended setting)                                                                                 |
|                                     | LAN    |                                                                                                                                                                                   |
|                                     | MEDIUM | Connect in 8bit color. Display in the different color shade from NC screen.                                                                                                       |
|                                     | MODEM  | Connect in 6bit color. Display in the different color shade from NC screen.                                                                                                       |
|                                     | SLOW   | Connect in 3bit color. Display in the particularly different color shade from NC screen.                                                                                          |
|                                     | MANUAL | Click [Options...] to set.                                                                                                                                                        |
| View Only                           |        | The operation from VNC client cannot be performed. Do not check this box.                                                                                                         |
| Auto Scaling                        |        | Expand the VNC client screen according to the screen of external computer. Set this as necessary.                                                                                 |
| Confirm Exit                        |        | Display the confirmation message when VNC client is ended. Set this as necessary.                                                                                                 |
| Use DSMPlugin                       |        | Setting for communication encryption. Do not check this box as VNC server function does not support encryption.                                                                   |
| Proxy/Repeater                      |        | Setting to connect VNC client to the NC of a factory network from the external network. Do not check this box as VNC server function does not support the connection using Proxy. |
| Save connection settings as default |        | Save the settings as default. Set this as necessary.                                                                                                                              |















### Note

- (1) When operating VNC client and actual NC unit simultaneously, the operation may not performed as expected.
- (2) Even when the NC is turned OFF while connecting to VNC client, VNC client keeps communicating with NC while displaying the screen at the time of power OFF in order to update the display. In that case, close VNC client once and then turn ON the NC again before connecting to VNC client again.
- (3) While connecting to VNC client, if you attempt to connect to "UltraVNC Viewer", "Connecting..." keeps displaying and the connection cannot be made.
- (4) When VNC client is operated on the computer using wireless network, if the state that the operation is not performed for a certain period of time with VNC client, the screen update may be stopped. By operating VNC client, the screen update may be recovered.

### 14.2.2 Operating the NC Using the Keyboard

The key operation on the NC screen can be performed from the PC keyboard of VNC client.

The following table shows the correspondence between NC keyboard and PC keyboard.

| NC keyboard                                                                                 | PC keyboard | Supplement                                                                           | NC keyboard                                                                       | PC keyboard             | Supplement                           |
|---------------------------------------------------------------------------------------------|-------------|--------------------------------------------------------------------------------------|-----------------------------------------------------------------------------------|-------------------------|--------------------------------------|
|  (MONITOR) | Shift + F1  | Monitor screen (Monitr)                                                              | MENU8                                                                             | F8                      |                                      |
|  (SETUP)   | Shift + F2  | Setup screen (Setup)                                                                 | MENU9                                                                             | F9                      |                                      |
|  (EDIT)    | Shift + F3  | Edit screen                                                                          | MENU10                                                                            | F10                     |                                      |
|  (DIAGN)   | Shift + F4  | Diagnose screen (Diagn)                                                              |  | F11                     | Return (menu)                        |
|  (MAINTE)  | Shift + F5  | Maintenance screen (Mainte)                                                          |  | F12                     | Next menu                            |
|            | Ctrl + F1   | System switching                                                                     | DELETE                                                                            | Delete                  | DELETE                               |
|            | Ctrl + F2   | Display/non-display of the operation guidance, parameter guidance and alarm guidance | INSERT                                                                            | Insert                  | INSERT                               |
|                                                                                             |             |                                                                                      | C.B.                                                                              | Shift + Home            | Clear the input area                 |
|            | Ctrl + F6   | Select the previous screen<br>Valid on the diagnosis or maintenance screen           | CAN                                                                               | Esc                     |                                      |
|                                                                                             |             |                                                                                      | ENTER                                                                             | Enter                   |                                      |
|           | Ctrl + F8   | Display/non-display of menu List                                                     | ↑                                                                                 | ↑                       |                                      |
|          | Ctrl + F9   | Switch to the previous tab                                                           | ↓                                                                                 | ↓                       |                                      |
|          | Ctrl + F10  | Switch to the next tab                                                               | ←                                                                                 | ←                       |                                      |
|          | PageUp      | Display the previous page                                                            | →                                                                                 | →                       |                                      |
|          | PageDown    | Display the next page                                                                | Left tab ( ←)                                                                     | Shift + Tab             | Move the cursor of input target data |
| MENU1                                                                                       | F1          |                                                                                      | Right tab (→ )                                                                    | Tab                     | Move the cursor of input target data |
| MENU2                                                                                       | F2          |                                                                                      | A to Z                                                                            | A to Z                  | Alphabet                             |
| MENU3                                                                                       | F3          |                                                                                      | 0 to 9                                                                            | 0 to 9                  | Numbers                              |
| MENU4                                                                                       | F4          |                                                                                      | + - / * @ , . ! ; : ( )                                                           | + - / * @ , . ! ; : ( ) | Function symbol                      |
| MENU5                                                                                       | F5          |                                                                                      | [ ] # \$ =                                                                        | [ ] # \$ =              |                                      |
| MENU6                                                                                       | F6          |                                                                                      |                                                                                   |                         |                                      |
| MENU7                                                                                       | F7          |                                                                                      |                                                                                   |                         |                                      |

Uppercase/lowercase letters at the time of alphabet input can be switched with CapsLock key or Shift key on the external computer in which VNC client is operated.

#### Note

(1) Even if the parameter "#19701 Restrain VNCserver" is set to "2", the operations other than Enter key from the computer and [INPUT] key on the software keyboard cannot be restrained.

### 14.2.3 Imposing Restrictions to VNC Client Operations

When the parameter "#19701 Restrain VNCserver" is set to "2", the operations of Enter key from the computer and [INPUT] key on the software keyboard are invalid.

## 14.3 Troubleshooting

The following shows the countermeasures for general troubles related to VNC client connection.

| Symptom                                                                   | Possible cause                                                                                                                                                                                                         | Countermeasure                                                                                                                                                                                                                                                        |
|---------------------------------------------------------------------------|------------------------------------------------------------------------------------------------------------------------------------------------------------------------------------------------------------------------|-----------------------------------------------------------------------------------------------------------------------------------------------------------------------------------------------------------------------------------------------------------------------|
| Cannot connect to VNC client.                                             | LAN cable is not connected.                                                                                                                                                                                            | Connect LAN cable to LAN1 terminal of the NC or non-Windows-based display unit in which VNC server is operated.                                                                                                                                                       |
|                                                                           | The parameters "#1953 Intra IP address", "#1954 Intra Subnet mask" and "#1955 Intra Gateway" are not set properly.                                                                                                     | Set the same group IP address to parameters #1953, #1954 and #1955 as the external computer/tablet type computer in which VNC client is operated.                                                                                                                     |
|                                                                           | Password is not set in the parameter "#19702 VNC password".                                                                                                                                                            | Set the password to the parameter "#19702".                                                                                                                                                                                                                           |
|                                                                           | The port No. set in the parameter "#19703 VNC server port" is already used elsewhere in the network.                                                                                                                   | Set the recommended value "5901" in the parameter "#19703 VNC server port".                                                                                                                                                                                           |
|                                                                           | Another VNC client is already connected.                                                                                                                                                                               | While already connecting to another VNC client, if you attempt to connect a new VNC client, "Connecting..." keeps displaying and the connection cannot be made. When there is already VNC client connected, disconnect it first before connecting another VNC client. |
|                                                                           | VNC client which does not support RFB protocol 3.3, 3.7 and 3.8 is used.                                                                                                                                               | Use VNC client which supports RFB protocol 3.3, 3.7 and 3.8.                                                                                                                                                                                                          |
|                                                                           | VNC client which does not support the security type "VNC Authentication" is used.                                                                                                                                      | Use VNC client which supports the security type "VNC Authentication".                                                                                                                                                                                                 |
|                                                                           | VNC client application terminated illegally.                                                                                                                                                                           | If a new connection cannot be made after VNC client application is terminated in the external computer, it may be re-connected by restarting the computer.                                                                                                            |
|                                                                           | [For M80]<br>The parameters "#1926 Global IP address", "#1927 Subnet mask" and "#1928 Global Gateway" are not set to the same values as "#1953 Intra IP address", "#1954 Intra Subnet mask" and "#1955 Intra Gateway". | Connection cannot be made unless #1926 to #1928 are set to the same values as #1953 to #1955.                                                                                                                                                                         |
|                                                                           | [For M800S]<br>The parameters "#1926 Global IP address" and "#1953 Intra IP address" are not set to the IP address used in the same group.                                                                             | #1926 and #1953 need to be set to the IP address used in the same group.<br>Set #1954 and #1955 to the same values as #1927 and #1928. When the different value is set, the connection cannot be made.                                                                |
| The screen displayed with VNC client is different from the actual colors. | The parameter "#19704 VNC color depth" is set to "1".                                                                                                                                                                  | When #19704 is set to "1", the displayed color is reduced to 8bit color.<br>In order to display as same as the NC screen color, set #19704 to "0" and select "ULTRA" in the "UltraVNC Viewer" connection setting.                                                     |
|                                                                           | "MEDIUM", "MODEM" or "SLOW" is selected in the "UltraVNC Viewer" connection setting.                                                                                                                                   | When "MEDIUM", "MODEM" or "SLOW" is selected, the displayed color is reduced to 8bit or less color.<br>In order to display as same as the NC screen color, select "ULTRA" and set the parameter "#19704 VNC color depth" to "0".                                      |

| Symptom                                            | Possible cause                                                      | Countermeasure                                                                                                                                                                                                                                                                                                                                                          |
|----------------------------------------------------|---------------------------------------------------------------------|-------------------------------------------------------------------------------------------------------------------------------------------------------------------------------------------------------------------------------------------------------------------------------------------------------------------------------------------------------------------------|
| The operation from VNC client cannot be performed. | [View Only] is checked in the "UltraVNC Viewer" connection setting. | As the operation from VNC client cannot be performed at all with [View Only] checked, remove the check.                                                                                                                                                                                                                                                                 |
|                                                    | The parameter "#19701 Restrain VNCserver" is set to "2".            | When the parameter #19701 is set to "2", the operations of Enter key on the computer and [INPUT] key on the software keyboard are invalid. In order to enable the operations, set #19701 to "1".                                                                                                                                                                        |
|                                                    | -                                                                   | Gesture operations using two fingers (enlarging or reducing of 3D check shape, drag operations such as rotation, etc.) or the operations by holding down (long tapping) (displaying the parameter guidance, etc.) cannot be performed regardless of the parameter settings.                                                                                             |
| The update of VNC client display is slow.          | -                                                                   | By changing the setting of the parameter "#19705 VNC transmit cycle" to "1" or "2", the update may get faster.<br>However, if the setting of #19705 is changed to other than "0", the screen update on NC unit may be slow.                                                                                                                                             |
|                                                    | -                                                                   | By changing the parameter "#19704 VNC color depth" to "1" and select "ULTRA" in the "UltraVNC Viewer" connection setting, the update may get faster.<br>However, if the setting of #19704 is changed to "1" and "ULTRA" is selected in the "UltraVNC Viewer" connection setting, the displayed color is reduced on VNC client, which is different from NC screen color. |



## Appendix 2: IP Filter Setting Function



This function prevents unauthorized access from external devices by filtering the IP address of the access source when the NC is being connected to Ethernet. By setting the IP addresses to be passed or rejected, access from external devices can be restricted.

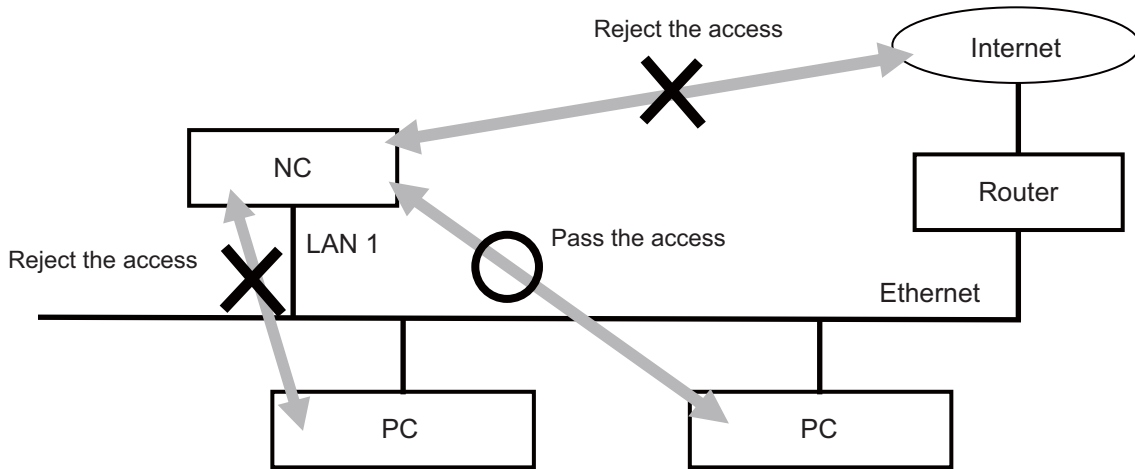

### 15.1 Setting the IP Address Filter

To enable the IP filter setting function, set the relevant parameters and then turn the power ON again. You can set IP addresses for each LAN communication port of an NC whether to permit or restrict the access.

The restriction for the access is set by the parameter #8910 or #9830.

| Setting value | Restriction | Details                                                                                                                                                                                         |
|---------------|-------------|-------------------------------------------------------------------------------------------------------------------------------------------------------------------------------------------------|
| 0             | Disabled    | Disable the IP filter setting function.                                                                                                                                                         |
| 1             | Pass        | When the range of IP addresses from which access to the NC should be allowed is set, access from an IP address within the range is permitted. Access from the other IP addresses is restricted. |
| 2             | Reject      | When the range of IP addresses to block is set, access from an IP address within the range is blocked. Access from the other IP addresses is permitted.                                         |

Set the range of IP addresses (starting and ending IP addresses) to the following parameters. Up to 8 ranges of IP addresses can be set.

LAN port and setting range of the parameters for the respective model

| Connector name |               | Parameter No.              | Details                                                              |
|----------------|---------------|----------------------------|----------------------------------------------------------------------|
| M800W/M80W     | M800S/M80/E80 |                            |                                                                      |
| LAN            | LAN1          | #9810                      | IP filter setting for LAN1<br>0: Invalid      1: Pass      2: Reject |
|                |               | #9811/#9812 to #9825/#9826 | Starting/ending IP filter setting<br>LAN1-1 to LAN1-8                |
| GDI            | LAN2          | #9830                      | IP filter setting for LAN2<br>0: Invalid      1: Pass      2: Reject |
|                |               | #9831/#9832 to #9845/#9846 | Starting/ending IP filter setting<br>LAN2-1 to LAN2-8                |

## 15.2 Examples for Using IP Address Filter

### ■ To permit (pass) the access from only one device

Set the same value to the starting and ending IP addresses.

<Parameter settings>

```
#9810 IP Filter for LAN1: 1
#9811 StartFiltIP LAN1-1: 10.20.30.3
#9812 EndFilterIP LAN1-2: 10.20.30.3
```

<Operation>

Access to the NC from "10.20.30.3" is permitted, and access from the other IP addresses is restricted.

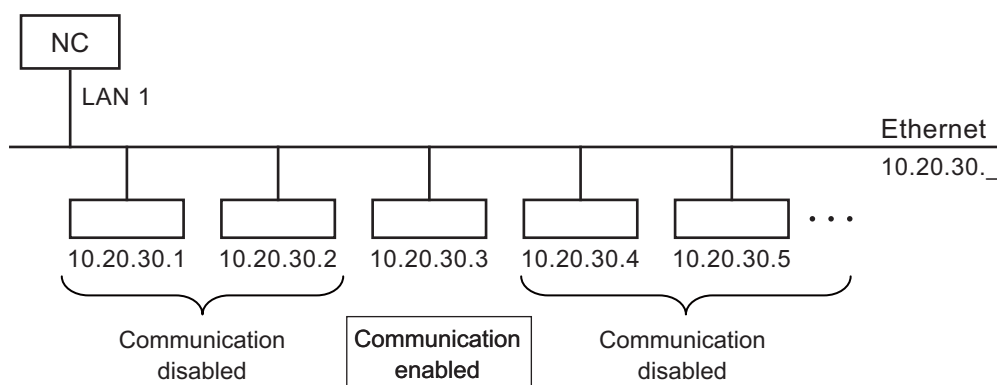

### ■ To restrict (reject) the access from multiple ranges of IP addresses, and to permit the access from the other IP addresses

<Parameter settings>

```
#9810 IP Filter for LAN1: 2
#9811 StartFiltIP LAN1-1: 10.20.30.2
#9812 EndFilterIP LAN1-1: 10.20.30.2
#9813 StartFiltIP LAN1-2: 10.20.30.4
#9814 EndFilterIP LAN1-2: 10.20.30.5
```

<Operation>

Access to the NC from "10.20.30.2", and from the range of "10.20.30.4" to "10.20.30.5" is restricted, and access from the other IP addresses is permitted.

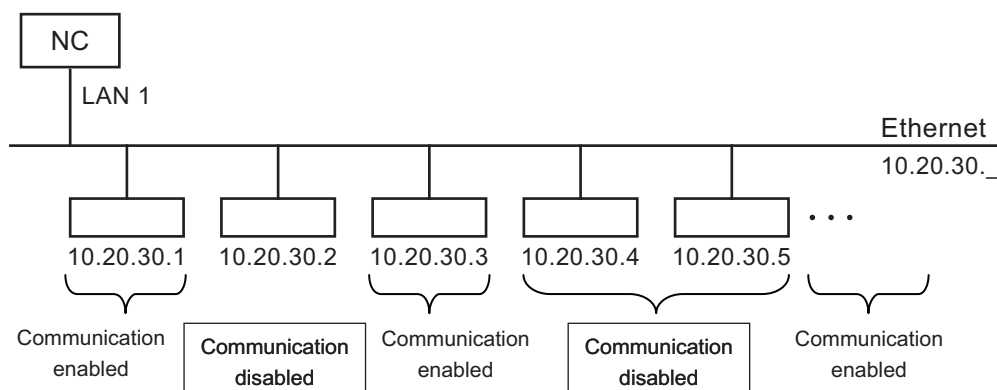

■ To permit (pass) the access from multiple ranges of IP addresses, and to restrict the access from the other IP addresses

<Parameter settings>

#9810 IP Filter for LAN1: 1

#9811 StartFilterIP LAN1-1: 10.20.30.3

#9812 EndFilterIP LAN1-1: 10.20.31.4

<Operation>

Access to the NC from the range of "10.20.30.3" to "10.20.30.254" and "10.20.31.1" to "10.20.31.4" is permitted, and access from the other IP addresses is restricted.

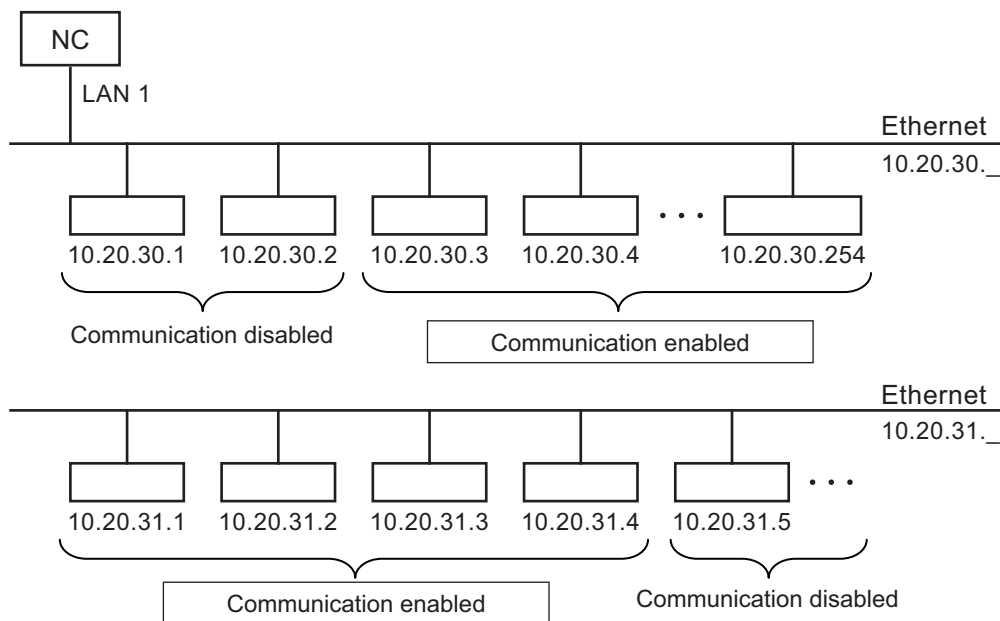

**Precautions**

- (1) Do not restrict the access from the IP address of the separate type display unit. This causes that the NC cannot communicate with the display unit. If the setting is already made, perform the steps (a) to (e) below to solve the problem.
  - (a) While the NC power is being OFF, set the rotary switch of the control unit to "B", and then turn the NC power ON.
  - (b) After the display of 7-segment LEDs changes "0y", turn the NC power OFF.
  - (c) Turn the rotary switch to "0" again.
  - (d) Turn the NC power ON.
  - (e) By performing the steps (a) to (d), the NC restarts with the IP filter setting function temporarily disabled. Reset the parameter setting for IP filter to an appropriate value.

If you turn the NC power OFF without changing the parameter setting in the step (e), the remedy should be performed from step (a) again.
- (2) For the setting of IP addresses, it need not be in ascending order. Even though the value of the starting IP address is larger than that of the ending IP address, the addresses in the setting range are targets for the IP filter setting function.
- (3) When there is the range which includes either the starting or ending IP address set to "0.0.0.0", "Y05 Initial parameter error" is displayed.
- (4) When the IP filter setting function is enabled ("Pass" or "Reject" is selected) with no valid IP address range, "Y05 Initial parameter error" is displayed and IP filter setting function is disabled.
- (5) "0.0.0.0" cannot be used for the valid IP address because this address has special meaning. Broadcasting IP address (end of the address is "255") cannot be used for the valid IP address either.
- (6) Even if the range which includes the IP address of an NC is set to prohibit the access, communication with the NC can be made properly.

---

## Appendix 3: List of Function Codes

| Function code            | Control unit recognition | PARITY V    | Screen display | Setting and display unit              | In memory  | Punch-output                     | Internal NC system function                                                |
|--------------------------|--------------------------|-------------|----------------|---------------------------------------|------------|----------------------------------|----------------------------------------------------------------------------|
| ISO                      |                          | V count     |                | Key-in                                | Store      | ISO                              |                                                                            |
| 0 to 9                   | Yes                      | Counted     | Displayed      | Key-in                                | Stored     | 0 to 9                           | Numerical data                                                             |
| A to Z                   | Yes                      | Counted     | Displayed      | Key-in                                | Stored     | A to Z                           | Addresses                                                                  |
| +                        | Yes                      | Counted     | Displayed      | Key-in                                | Stored     | +                                | Sign, variable operator (+)                                                |
| -                        | Yes                      | Counted     | Displayed      | Key-in                                | Stored     | -                                | Sign, variable operator (-)                                                |
| .                        | Yes                      | Counted     | Displayed      | Key-in                                | Stored     | .                                | Decimal point                                                              |
| ,                        | Yes                      | Counted     | Displayed      | Key-in                                | Stored     | ,                                |                                                                            |
| /                        | Yes                      | Counted     | Displayed      | Key-in                                | Stored     | /                                | Block delete (optional block skip)<br>Variable operator (÷)                |
| %                        | Yes                      | Counted     | Displayed (%)  | No Key-in<br>(automatically inserted) | Stored     | %                                | End of record (tape storage end)<br>Rewind start & stop during tape search |
| LF/NL                    | Yes                      | Counted     | Displayed (;)  | Key-in<br>;/EOB                       | Stored     | LF                               | End of block                                                               |
| (                        | Yes                      | Counted     | Displayed      | Key-in<br>;/EOB                       | Stored     | (                                | Control out (comment start)                                                |
| )                        | Yes                      | Counted     | Displayed      | Key-in<br>;/EOB                       | Stored     | )                                | Control in (comment end)                                                   |
| :                        | Yes                      | Counted     | Displayed      | No Key-in                             | Stored     | :                                | Program number address (instead of O.)                                     |
| #                        | Yes                      | Counted     | Displayed      | Key-in                                | Stored     | #                                | Variable number                                                            |
| *                        | Yes                      | Counted     | Displayed      | Key-in                                | Stored     | *                                | Variable operator (X)                                                      |
| =                        | Yes                      | Counted     | Displayed      | Key-in                                | Stored     | =                                | Variable definition                                                        |
| [                        | Yes                      | Counted     | Displayed      | Key-in                                | Stored     | [                                | Variable operator                                                          |
| ]                        | Yes                      | Counted     | Displayed      | Key-in                                | Stored     | ]                                | Variable operator                                                          |
| BS                       | No                       |             | Not displayed  | No Key-in                             | Stored     |                                  |                                                                            |
| HT                       | No                       |             | Not displayed  | No Key-in                             | Stored     |                                  |                                                                            |
| SP                       | No                       |             | Not displayed  | Key-in                                | Stored     | SP<br>(T-V) Automatic adjustment |                                                                            |
| CR                       | No                       |             | Not displayed  | No Key-in                             | Stored     |                                  |                                                                            |
| DEL                      | No                       | Not Counted | Not displayed  | No Key-in                             | Not Stored |                                  |                                                                            |
| NULL                     | No                       | Not Counted | Not displayed  | No Key-in                             | Not Stored |                                  |                                                                            |
| Any other than the above | No                       | Counted     | (*1)           | No Key-in                             | Stored     |                                  |                                                                            |

(\*1) This denotes characters (including blanks) which are stored inside and which correspond to the command codes. "@" is not displayed.

### Note

(1) Codes not listed in the above table are stored on tape, but an error will result during operation if they are not comments.

## **Appendix 4: RS-232C I/O Device Parameter Setting Examples**

| Parameter setting examples | Cable connection<br>Parameter setting examples                         |                                                                          |                                                                      |                                                                                 |                                                                                 | Follows communication protocol.<br>(NC side)<br>2:SD<br>3:RD<br>4:RS<br>5:CS<br>6:DR<br>20:ER<br>7:GND |
|----------------------------|------------------------------------------------------------------------|--------------------------------------------------------------------------|----------------------------------------------------------------------|---------------------------------------------------------------------------------|---------------------------------------------------------------------------------|--------------------------------------------------------------------------------------------------------|
|                            | NC I/O                                                                 | NC I/O                                                                   | NC I/O                                                               | NC I/O                                                                          | NC I/O                                                                          |                                                                                                        |
|                            | 1 — 1<br>2 × 2<br>3 × 3<br>4 × 4<br>5 × 5<br>6 × 6<br>20 × 20<br>7 — 7 | 1 — 1<br>2 × 2<br>3 × 3<br>14 × 14<br>5 × 5<br>6 × 6<br>20 × 20<br>7 — 7 | 1 — 1<br>2 × 2<br>3 × 3<br>4 4<br>5 8<br>6 ]<br>20 ]<br>8 ]<br>7 — 7 | 1 — 1<br>2 × 2<br>3 × 3<br>4 ] 4<br>5 ] 5<br>6 ] 6<br>20 ] 20<br>8 ] 8<br>7 — 7 | 1 — 1<br>2 × 2<br>3 × 3<br>4 × 4<br>5 × 5<br>6 ] 6<br>20 ] 20<br>8 ] 8<br>7 — 7 |                                                                                                        |
| Device name                |                                                                        |                                                                          |                                                                      |                                                                                 |                                                                                 | Follows communication software.                                                                        |
| BAUD RATE                  | 2                                                                      | 2                                                                        | 2                                                                    | 2                                                                               | 2                                                                               |                                                                                                        |
| STOP BIT                   | 3                                                                      | 3                                                                        | 3                                                                    | 3                                                                               | 3                                                                               |                                                                                                        |
| PARITY EFFECTIVE           | 0                                                                      | 0                                                                        | 0                                                                    | 0                                                                               | 0                                                                               |                                                                                                        |
| EVEN PARITY                | 0                                                                      | 0                                                                        | 0                                                                    | 0                                                                               | 0                                                                               |                                                                                                        |
| CHR. LENGTH                | 3                                                                      | 3                                                                        | 3                                                                    | 3                                                                               | 3                                                                               |                                                                                                        |
| HAND SHAKE                 | 3                                                                      | 2                                                                        | 3                                                                    | 3                                                                               | 3                                                                               |                                                                                                        |
| DC CODE PARITY             | 1                                                                      | 0                                                                        | 1                                                                    | 1                                                                               | 1                                                                               |                                                                                                        |
| DC2/DC4 OUTPUT             | 0                                                                      | 0                                                                        | 1                                                                    | 0                                                                               | 1                                                                               |                                                                                                        |
| CR OUTPUT                  | 0                                                                      | 0/1                                                                      | 0                                                                    | 0                                                                               | 0                                                                               |                                                                                                        |
| FEED CHR.                  | 0                                                                      | 0                                                                        | 0                                                                    | 0                                                                               | 0                                                                               |                                                                                                        |
| PARITY V                   | 0                                                                      | 0                                                                        | 0                                                                    | 0/1                                                                             | 0/1                                                                             |                                                                                                        |
| TIME-OUT SET               | 100                                                                    | 100                                                                      | 100                                                                  | 100                                                                             | 100                                                                             |                                                                                                        |

## Appendix 5: Other Functions for Reference



## 18.1 F1-digit Feed

The feedrate registered by parameter can be assigned by designating a single digit following address F.

There are six F codes: F0 and F1 to F5. The rapid traverse rate is applied when F0 is issued which is the same as the G00 command.

When one of the codes from F1 to F5 is issued, the cutting feedrate set to support the code serves as the valid rate command.

If F6 or larger value is command, the value is regarded as the cutting feedrate which has been directly commanded with numerical values.

When "F1-digit speed change valid" signal is valid when F1-digit feed is issued, a feedrate which is set by a parameter can be increased or decreased by operating the manual handle.

Refer to "Programming Manual" for more details on F1-digit feed.

### Validate the F1-digit feedrate

To validate the F1-digit feed, the parameter "#1079 f1digit" or "#8145 Validate F1 digit" must be ON.

When the F1-digit feed is valid, the feedrate of each command is as follows:

F0: Rapid traverse rate

F1 to F5: The feedrate configured by the corresponding parameter "#1185 spd\_F1" to "#1185 spd\_F5"(F1 digit feedrate F1 to F5)

### Enabling conditions of the speed change with the handle

When the F1-digit command is valid, the feedrate can be increased/decreased by operating the first manual handle. (The feedrate cannot be changed by the 2nd and 3rd handles.)

Changing the feedrate by the handle is available satisfying the following conditions:

- (1) The operation must be in automatic start.
- (2) The operation must be in cutting feed, and F1-digit feedrate command must be issued.
- (3) The F1-digit feed parameter must be ON.
- (4) The F1-digit feed switch must be ON.
- (5) The operation must not be in handle mode.
- (6) The operation must not be in dry run.
- (7) Upper limit of F1-digit feedrate ("#1506 F1\_FM") and F1-digit feedrate change constant("#1507 F1\_K F1") are not zero.

### Conversion of the F1-digit feedrate changing with handle operation

Once the F1-digit feedrate is changed with manual handle, the changed feedrate is valid until parameter is changed or the power is turned OFF. Changed feedrate can be checked only during the operation. Note that if the parameter "#1246 set18(bit16)" (switch over of the F1-digit feedrate changing method) is set to "1", even after the power is turned OFF, operation is kept at the changed feedrate because the parameter of F1-digit feedrate has been changed. In this case, if the screen is not switched, the changed parameter values are not reflected to the display.

The increase/decrease amount per handle gradient is expressed with the following equation.

$$\Delta F = \Delta P \times \frac{FM}{K}$$

$\Delta P$ : Handle pulse ( $\pm$ )  
 $FM$ : Upper limit of F1-digit feedrate (#1506 F1\_FM)  
 $K$ : F1-digit feedrate change constant (#1507 F1\_K)

(Example) When the handle scale unit is to be made  $\pm 10$ mm/min.

If FM is made 3600mm/min, feedrate change constant (K) must be set to "360" according to the following formula.

$$\Delta F = 10 = 1 \times \frac{3600}{K}$$

### Note

- (1) If F1-digit feedrate changing valid signal is turned ON when F1-digit feed is commanded and changing feedrate with the manual handle is valid, it is clamped at the upper limit of F1-digit feedrate if the F1-digit feedrate is greater than the upper limit of F1-digit feedrate.
- (2) When the F1-digit feedrate is 0 with the handle operation during the F1-digit feedrate command, the alarm "M01 F1-digit feedrate zero 0104" will occur. This alarm can be eliminated when the F1-digit feedrate is set in larger value than 0 with the handle operation.
- (3) When K is 0, the speed is not changed.

### Precautions

- (1) The number of manual handle pulses is 1 pulse per scale unit regardless of the scaling factor.
- (2) During a F1-digit feed command, the F1-digit feed number and F1-digit feed command signal are output as the PLC signals.
- (3) When F1. to F5. (with decimal point) are assigned, the 1mm/min to 5mm/min (direct numerical value command) are established instead of the F1-digit feed command.
- (4) When the commands are used with inch command, one-tenth of the feedrate set correspond to F1 to F5 serves at the assigned speed inch/min.
- (5) When the commands are used with the millimeter or degree units, the feedrate set to correspond to F1 to F5 serves as the assigned speed mm ( $^{\circ}$ )/mm.
- (6) When both the F1-digit feedrate changing and the manual speed command are present, the manual speed command will have the priority.
- (7) In the synchronous tapping command, the speed cannot be changed with the handle.



## Revision History

| Date of revision | Manual No.      | Revision details                                                                                                                                                                                                                                                                                                                                                                                                                                                                                                                                                                                                                                                                                                                                                                                                                                                                                                                                                                                                                                                                                                                                                                                                                                                                                                                                                                                                                                                                                                                                                                                                                                                                                                                                                                                                                                                                                                                                                                                                                                                                                                                 |
|------------------|-----------------|----------------------------------------------------------------------------------------------------------------------------------------------------------------------------------------------------------------------------------------------------------------------------------------------------------------------------------------------------------------------------------------------------------------------------------------------------------------------------------------------------------------------------------------------------------------------------------------------------------------------------------------------------------------------------------------------------------------------------------------------------------------------------------------------------------------------------------------------------------------------------------------------------------------------------------------------------------------------------------------------------------------------------------------------------------------------------------------------------------------------------------------------------------------------------------------------------------------------------------------------------------------------------------------------------------------------------------------------------------------------------------------------------------------------------------------------------------------------------------------------------------------------------------------------------------------------------------------------------------------------------------------------------------------------------------------------------------------------------------------------------------------------------------------------------------------------------------------------------------------------------------------------------------------------------------------------------------------------------------------------------------------------------------------------------------------------------------------------------------------------------------|
| May. 2015        | IB(NA)1501274-A | First edition created.                                                                                                                                                                                                                                                                                                                                                                                                                                                                                                                                                                                                                                                                                                                                                                                                                                                                                                                                                                                                                                                                                                                                                                                                                                                                                                                                                                                                                                                                                                                                                                                                                                                                                                                                                                                                                                                                                                                                                                                                                                                                                                           |
| Nov. 2015        | IB(NA)1501274-B | <p>Added or modified the following contents to the A4 version of the system software.</p> <p>Added the following chapters:</p> <ul style="list-style-type: none"> <li>- 2.4.8 Changing the Screen Theme Color</li> <li>- 2.8 Changing the Operation Level (Protect Setting Screen)</li> <li>- 2.10.3 Operating the Screen by Touch Gestures</li> <li>- 2.12 Assigning Arbitrary Character String to User-defined Key</li> <li>- 3.8 Editing a Multi-part System Program</li> <li>- 9.2.1.6 Switching the Coordinate System Direction of a Workpiece Graphic</li> <li>- 9.9 Thread Recutting Function</li> </ul> <p>Moved the following chapters:</p> <ul style="list-style-type: none"> <li>- 3.8.2 Special Program Editing Display for Synchronization between Part Systems</li> <li>- 6.9 Setting Workpiece Coordinate System Shift</li> </ul> <p>Added description to the following chapters:</p> <ul style="list-style-type: none"> <li>- 1 Outline of Menu Items</li> <li>- 2.1 Display Unit and Keyboard Unit</li> <li>- 2.4.7 Menus</li> <li>- 5.3 Transferring a File</li> <li>- 6.9 Setting Workpiece Coordinate System Shift</li> <li>- 7.2 Selecting High-accuracy Control Parameters (Machining Cond I Screen)</li> <li>- 9.2.1 Selecting where to register a Machining Surface (Machining Surface List Screen)</li> <li>- 10.4 Restart Search</li> <li>- 11.1.1 Alarm History</li> <li>- 11.2.1 System Configuration Screen</li> <li>- 11.2.3 Display Items for the Servo Axis Unit (Drive Monitor Screen)</li> <li>- 11.2.4 Display Items for the Spindle Unit (Drive Monitor Screen)</li> <li>- 11.2.5 Display Items for the Power Supply Unit (Drive Monitor Screen)</li> <li>- 11.3.3 Collecting the Data on the Diagnosis Data Collection Setting Screen</li> </ul> <p>Deleted the following chapters:</p> <ul style="list-style-type: none"> <li>- 3.4.3 Standard Fixed Cycle Subprogram (For L system)</li> <li>- 3.4.4 Standard Fixed Cycle Subprogram (For M system)</li> </ul> <p>Refer to the "Programming Manual" for details on the fixed cycle program.</p> <p>Also, corrected wrong indications.</p> |
| Mar. 2016        | IB(NA)1501274-C | <p>Added or modified the following contents to the B2 version of the system software.</p> <p>Added the following chapters:</p> <ul style="list-style-type: none"> <li>- 2.4 Home Screen</li> <li>- 3.8 Inserting Cycle Interactively</li> <li>- 4.3.9 Checking a Machining Program between Part Systems</li> <li>- 12.7.4 ALL PRM Input</li> </ul> <p>Moved the following chapters:</p> <ul style="list-style-type: none"> <li>- 2.3 Standard Screen</li> <li>- 2.5 19-type Vertical Display Unit and Home Applications</li> </ul> <p>Also, corrected wrong indications.</p>                                                                                                                                                                                                                                                                                                                                                                                                                                                                                                                                                                                                                                                                                                                                                                                                                                                                                                                                                                                                                                                                                                                                                                                                                                                                                                                                                                                                                                                                                                                                                     |

| Date of revision | Manual No.      | Revision details                                                                                                                                                                                                                                                                                                                                                                                                                                                                                                                                                                                                                                                                                                                                                                                                                                                                                                                                                                                                                                                                                                                                                                                                                                        |
|------------------|-----------------|---------------------------------------------------------------------------------------------------------------------------------------------------------------------------------------------------------------------------------------------------------------------------------------------------------------------------------------------------------------------------------------------------------------------------------------------------------------------------------------------------------------------------------------------------------------------------------------------------------------------------------------------------------------------------------------------------------------------------------------------------------------------------------------------------------------------------------------------------------------------------------------------------------------------------------------------------------------------------------------------------------------------------------------------------------------------------------------------------------------------------------------------------------------------------------------------------------------------------------------------------------|
| Oct. 2016        | IB(NA)1501274-D | <p>Added or modified the following contents in response to the C1 version of the system software.</p> <p>Added the following chapters:<br/> - 2.4.4 Operating Applications<br/> - 7.1.4 Undoing the Parameter Change</p> <p>Deleted the following chapters:<br/> - 13.2 Periodic Maintenance</p> <p>Also, corrected wrong indications.</p>                                                                                                                                                                                                                                                                                                                                                                                                                                                                                                                                                                                                                                                                                                                                                                                                                                                                                                              |
| Feb. 2017        | IB(NA)1501274-E | <p>Added or modified the following contents to the C3 version of the system software.</p> <p>Added the following contents:<br/> - 2.4.5 Displaying the Manuals<br/> - 3.7.6 Displaying the Finished Shape<br/> - 4.4.1 Searching T List<br/> - 6.4.5 Undoing Change of Tool Compensation Data<br/> - 9.10 Email Notification Function to Operator</p> <p>Changed the following contents:<br/> - 4.2.8 Setting the Tool Shape<br/> - 4.3.8 Setting the Tool Shape<br/> - 6.5 Setting the Tool Management Data (Tool Management Screen)<br/> - 12.9 Performing Batch Backups of NC Memory Data</p> <p>Moved the following contents:<br/> - 2.11 Changing the Operation Level (Protect Setting Screen)<br/> - 16.1 F1-digit Feed</p> <p>Deleted the following contents:<br/> - 10.7 Other Functions<br/> - 11.4 System Lock (When an Expiry Date is Displayed)<br/> - 11.6 IP Address Resetting Procedure at Disabled Network Communication [M800W/M80W Series Only]<br/> - 12.7.4 M2 Macro Converter<br/> - 12.8.6 Application Error Detection<br/> - 18.1 Computer Link B<br/> - 18.2 Manual Synchronous Tapping<br/> - Appx.2: Table of Command Value Ranges<br/> - Appx.3: Circular Cutting Radius Error</p> <p>Also, corrected wrong indications.</p> |
| Dec. 2017        | IB(NA)1501274-F | <p>The descriptions were revised corresponding to S/W version C7 of Mitsubishi CNC M800/M80 series.</p> <p>Added the following contents:<br/> - 3.9.6 Highlighting the Cycle Program<br/> - 4.1.16 Setting the Drawing Speed of Program Check<br/> - 4.2.1 Switching Check Method<br/> - 4.2.4 Checking Multiple Part Systems Simultaneously<br/> - 4.2.5 Canceling the Program Check<br/> - 4.2.12 Setting the Drawing Speed of Program Check<br/> - 4.2.13 Drawing Travel Command of the Rotary Axis (Check Method II)<br/> - 4.3.1 Switching Check Method<br/> - 4.3.4 Checking Multiple Part Systems Simultaneously<br/> - 4.3.5 Canceling the Program Check<br/> - 4.3.13 Setting the Drawing Speed of Program Check<br/> - 5.10 Formatting Memory Card/DS/USB Memory<br/> - 6.10 Measuring the Workpiece Installation Error Data<br/> - 7.1.8 Setting VNC Server Connection Password<br/> - 12.8.6 Formatting Memory Card/DS/USB Memory<br/> - Appx.1: VNC Server Function</p>                                                                                                                                                                                                                                                                    |

(Continue to the next page)

| Date of revision | Manual No. | Revision details                                                                                                                                                                                                                                                                                                                                                                                                                                                                                                                                                                                                                                                                                                                                                                                                                                                                                                                                                                                                                                                                                                                                                                                                                                                                                                                                                                                                                                                                                                                                                                                                                                                                                                                                                                                                                                                                                                                                                                                                                                                                                                                                                                                                                      |
|------------------|------------|---------------------------------------------------------------------------------------------------------------------------------------------------------------------------------------------------------------------------------------------------------------------------------------------------------------------------------------------------------------------------------------------------------------------------------------------------------------------------------------------------------------------------------------------------------------------------------------------------------------------------------------------------------------------------------------------------------------------------------------------------------------------------------------------------------------------------------------------------------------------------------------------------------------------------------------------------------------------------------------------------------------------------------------------------------------------------------------------------------------------------------------------------------------------------------------------------------------------------------------------------------------------------------------------------------------------------------------------------------------------------------------------------------------------------------------------------------------------------------------------------------------------------------------------------------------------------------------------------------------------------------------------------------------------------------------------------------------------------------------------------------------------------------------------------------------------------------------------------------------------------------------------------------------------------------------------------------------------------------------------------------------------------------------------------------------------------------------------------------------------------------------------------------------------------------------------------------------------------------------|
|                  |            | <p style="text-align: right;">(Continued from the previous page)</p> <p>Changed the following contents:</p> <ul style="list-style-type: none"> <li>- 1. Outline of Menu Items</li> <li>- 2.3 Standard Screen</li> <li>- 2.3.2 NC Status</li> <li>- 2.3.9 Screen Transition Diagram</li> <li>- 2.9.3 Operating the Screen by Touch Gestures</li> <li>- 3.2 Creating and Editing a Machining Program</li> <li>- 3.6.9 Copying and Pasting Data</li> <li>- 3.7.6 Displaying the Finished Shape</li> <li>- 3.9.1 Types of Cycle</li> <li>- 3.9.3 Screen Configuration</li> <li>- 3.9.4 Operation Descriptions</li> <li>- 4.1 Graphic Check (2D)</li> <li>- 4.1.11 Setting Auto Graphic</li> <li>- 4.2 Graphic Check (3D) (M System)</li> <li>- 4.2.2 Checking Continuously</li> <li>- 4.2.16 Notes for Graphic Check (3D)</li> <li>- 4.3 Graphic Check (3D) (L System)</li> <li>- 4.3.2 Checking Continuously</li> <li>- 4.3.9 Performing an Interference Check</li> <li>- 4.3.10 Setting the Workpiece Shape</li> <li>- 4.3.12 Checking a Machining Program between Part Systems</li> <li>- 4.3.16 Notes for Graphic Check (3D)</li> <li>- 5.1 Inputting and Outputting a Program</li> <li>- 5.2 Selecting a Device, Directory and File</li> <li>- 5.7 Creating a Directory</li> <li>- 6.5 Setting the Tool Management Data (Tool Management Screen)</li> <li>- 6.5.1 List of Display Items</li> <li>- 6.5.4 Registering New Tool Management Data</li> <li>- 6.7.1 Workpiece Measurement (M System)</li> <li>- 7.2 Selecting High-accuracy Control Parameters (Machining Cond I Screen)</li> <li>- 10.2.1 Screen Layout</li> <li>- 10.2.3 Switching the Counter Types</li> <li>- 10.2.6 Counter All-axis Display</li> <li>- 10.4 Restart Search</li> <li>- 10.5 Collation and Stop</li> <li>- 10.6.2 Buffer Correction</li> <li>- 11.3.1 Self Diagnosis Screen</li> <li>- 11.4.4.2 Signal Monitor Screen</li> <li>- 11.4.4.4 Version Display Screen</li> <li>- 12. Performing a Backup Operation</li> <li>- 12.7.2 List Display</li> </ul> <p>Deleted the following contents:</p> <ul style="list-style-type: none"> <li>- 6.8.5 Compensating the Workpiece Installation Error Data</li> </ul> <p>Also, corrected wrong indications.</p> |

| Date of revision | Manual No.      | Revision details                                                                                                                                                                                                                                                                                                                                                                                                                                                                                                                                                                                                                                                                                                                                                                                                                                                                                                                                                                                                                                                                                                                                                                                                                                                                                                                                                                                                                                                                                                                                                                                                                                                                                                                                                                                                                                                                                                                                                                                                                                                               |
|------------------|-----------------|--------------------------------------------------------------------------------------------------------------------------------------------------------------------------------------------------------------------------------------------------------------------------------------------------------------------------------------------------------------------------------------------------------------------------------------------------------------------------------------------------------------------------------------------------------------------------------------------------------------------------------------------------------------------------------------------------------------------------------------------------------------------------------------------------------------------------------------------------------------------------------------------------------------------------------------------------------------------------------------------------------------------------------------------------------------------------------------------------------------------------------------------------------------------------------------------------------------------------------------------------------------------------------------------------------------------------------------------------------------------------------------------------------------------------------------------------------------------------------------------------------------------------------------------------------------------------------------------------------------------------------------------------------------------------------------------------------------------------------------------------------------------------------------------------------------------------------------------------------------------------------------------------------------------------------------------------------------------------------------------------------------------------------------------------------------------------------|
| Mar. 2018        | IB(NA)1501274-G | <p>The descriptions were revised corresponding to MITSUBISHI CNC E80 Series.<br/>The descriptions were revised corresponding to S/W version D1 of MITSUBISHI CNC M800 Series/M80 Series.</p> <p>Changed the following contents:</p> <ul style="list-style-type: none"> <li>- Introduction</li> <li>- Precautions for Safety</li> <li>- 3.2 Creating and Editing a Machining Program</li> <li>- 3.6.7 Searching for Character Strings</li> <li>- 3.7.6 Displaying the Finished Shape</li> <li>- 4.1 Graphic Check (2D)</li> <li>- 4.1.17 Notes for Graphic Check (2D)</li> <li>- 4.2 Graphic Check (3D) (M System)</li> <li>- 4.2.14 Availability of Check Mode with Other Functions</li> <li>- 4.2.15 Handling of Variable Commands, Programmable Parameter Input, and Programmable Compensation Data Input</li> <li>- 4.3 Graphic Check (3D) (L System)</li> <li>- 4.3.14 Availability of Check Mode with Other Functions</li> <li>- 4.4.1 Searching T List</li> <li>- 5.3 Transferring a File</li> <li>- 6.3.2 Tool Measurement (L System)</li> <li>- 6.4 Setting Tool Compensation Amount (Tool Offset Screen)</li> <li>- 6.4.6 Disabling the Setting of Tool Compensation Amount</li> <li>- 6.4.7 Measuring Tool Compensation Amount</li> <li>- 6.6.2 Displaying the Life Management Data in Group Units (M system)</li> <li>- 9.2.4 Surface Selection</li> <li>- 9.2.4.1 Selecting a Machining Target Surface</li> <li>- 10.1 Operation Search</li> <li>- 10.1.3 Changing the Sorting Method</li> <li>- 10.2 Checking the Movement under Machining (Monitor Screen)</li> <li>- 10.2.2 Switching the Display Format</li> <li>- 10.2.3 Switching the Counter Types</li> <li>- 10.2.4 Switching the Spindle No. to be Displayed on Counter</li> <li>- 11.2.1 System Configuration Screen</li> <li>- 11.3.1 Self Diagnosis Screen</li> <li>- 12.1 Selecting a Device, Directory and File</li> <li>- 12.2 Transferring a File</li> <li>- 12.9 Performing Batch Backups of NC Memory Data</li> <li>- 12.9.2 All Restoration</li> </ul> <p>Also, corrected wrong indications</p> |

| Date of revision | Manual No.      | Revision details                                                                                                                                                                                                                                                                                                                                                                                                                                                                                                                                                                                                                                                                                                                                                                                                                                                                                                                                                                                                                                                                                                                                                                                                                                                                                                                                                                                                                                                                                                                                                                                                                                                                                                                                                                                                                                                                                                                                                                                                                                                                                                                                                                                                                                                                                                                                                                                                                                                                                                                                                                                                                                                                                                    |
|------------------|-----------------|---------------------------------------------------------------------------------------------------------------------------------------------------------------------------------------------------------------------------------------------------------------------------------------------------------------------------------------------------------------------------------------------------------------------------------------------------------------------------------------------------------------------------------------------------------------------------------------------------------------------------------------------------------------------------------------------------------------------------------------------------------------------------------------------------------------------------------------------------------------------------------------------------------------------------------------------------------------------------------------------------------------------------------------------------------------------------------------------------------------------------------------------------------------------------------------------------------------------------------------------------------------------------------------------------------------------------------------------------------------------------------------------------------------------------------------------------------------------------------------------------------------------------------------------------------------------------------------------------------------------------------------------------------------------------------------------------------------------------------------------------------------------------------------------------------------------------------------------------------------------------------------------------------------------------------------------------------------------------------------------------------------------------------------------------------------------------------------------------------------------------------------------------------------------------------------------------------------------------------------------------------------------------------------------------------------------------------------------------------------------------------------------------------------------------------------------------------------------------------------------------------------------------------------------------------------------------------------------------------------------------------------------------------------------------------------------------------------------|
| May 2019         | IB(NA)1501274-H | <p>The descriptions were revised corresponding to S/W version E0 of MITSUBISHI CNC M800 Series/M80 Series/E80 Series.</p> <p>Added the following contents:</p> <ul style="list-style-type: none"> <li>- 2.13 Outputting the Screen Information (Screenshot Capture Function) (Only for Non-Windows-Based Display Unit)</li> <li>- 3.6.11 Searching T codes</li> <li>- 6.8.5 Changing the Input Menus to Display</li> <li>- 6.8.6 Compensating the Workpiece Installation Error Data</li> <li>- 6.8.7 Compensating the Workpiece Position for Rotary Axis</li> <li>- Appendix 2: IP Filter Setting Function</li> </ul> <p>Thoroughly revised the following contents:</p> <ul style="list-style-type: none"> <li>- 6.6 Tool Life Management</li> </ul> <p>Changed the following contents:</p> <ul style="list-style-type: none"> <li>- 2.3.9 Screen Transition Diagram</li> <li>- 2.7.1 Parameter Guidance</li> <li>- 2.7.2 Alarm Guidance</li> <li>- 2.9.3 Operating the Screen by Touch Gestures</li> <li>- 3.2 Creating and Editing a Machining Program</li> <li>- 3.4 Registering and Editing the Fixed Cycle Program</li> <li>- 3.8.2 Special Program Editing Display for Synchronization between Part Systems</li> <li>- 3.9.1 Types of Cycle</li> <li>- 4.1.6 Changing the Display Mode</li> <li>- 4.1.12 Availability of Check Mode with Other Functions</li> <li>- 4.1.17 Notes for Graphic Check (2D)</li> <li>- 4.2 Graphic Check (3D) (M System)</li> <li>- 4.2.4 Checking Multiple Part Systems Simultaneously</li> <li>- 4.2.10 Setting the Workpiece Shape</li> <li>- 4.2.14 Availability of Check Mode with Other Functions</li> <li>- 4.2.16 Notes for Graphic Check (3D)</li> <li>- 4.3 Graphic Check (3D) (L System)</li> <li>- 4.3.4 Checking Multiple Part Systems Simultaneously</li> <li>- 4.3.10 Setting the Workpiece Shape</li> <li>- 4.3.16 Notes for Graphic Check (3D)</li> <li>- 5.1 Inputting and Outputting a Program</li> <li>- 5.2 Selecting a Device, Directory and File</li> <li>- 5.3 Transferring a File</li> <li>- 5.4 Comparing Files (Compare)</li> <li>- 5.5 Erasing a File</li> <li>- 6.8 Setting Workpiece Coordinate System Offset</li> <li>- 6.10 Measuring the Workpiece Installation Error Data</li> <li>- 7.1.6 Echoback</li> <li>- 9.7 MDI Program Editing</li> <li>- 10.2.1 Screen Layout</li> <li>- 10.2.4 Switching the Spindle No. to be Displayed on Counter</li> <li>- 10.2.10 Load Meter Display</li> <li>- 10.4 Restart Search</li> <li>- 10.6.2 Buffer Correction</li> <li>- 11.2.1 System Configuration Screen</li> <li>- 11.3.3 Collecting the Data on the Diagnosis Data Collection Setting Screen</li> </ul> <p>Also, corrected wrong indications.</p> |



| Date of revision | Manual No.      | Revision details                                                                                                                                                                                                                                                                                                                                                                                                                                                                                                                                                                                                                                                                                                                                                                                                                                                                                                                                                                                                                                                                                                                                                                                        |
|------------------|-----------------|---------------------------------------------------------------------------------------------------------------------------------------------------------------------------------------------------------------------------------------------------------------------------------------------------------------------------------------------------------------------------------------------------------------------------------------------------------------------------------------------------------------------------------------------------------------------------------------------------------------------------------------------------------------------------------------------------------------------------------------------------------------------------------------------------------------------------------------------------------------------------------------------------------------------------------------------------------------------------------------------------------------------------------------------------------------------------------------------------------------------------------------------------------------------------------------------------------|
| Aug. 2019        | IB(NA)1501274-J | <p>The descriptions were revised corresponding to S/W version E1 of MITSUBISHI CNC M800 Series/M80 Series/E80 Series.</p> <p>Changed the following contents:</p> <ul style="list-style-type: none"> <li>- 2.3.9 Screen Transition Diagram</li> <li>- 2.4.4 Operating the Application</li> <li>- 2.4.5 Displaying the Manuals (M800W Windows-based Display Unit/M80W Windows-based Display Unit)</li> <li>- 3.6.11 Searching T codes</li> <li>- 6.3.2 Tool Measurement (L System)</li> <li>- 6.4 Setting Tool Compensation Amount (Tool Offset Screen)</li> <li>- 6.4.1 Setting the Tool Compensation Data</li> <li>- 6.5.1 List of Display Items</li> <li>- 6.5.2 Data Setting Range</li> <li>- 6.5.10 Copying and Pasting the Tool Management Data</li> <li>- 9.6 Manual Numerical Value Command</li> <li>- 11.2.1 System Configuration Screen</li> <li>- 11.3.1 Self Diagnosis Screen</li> <li>- 11.4.3 Collecting the NC Data (Data Sampling Screen)</li> <li>- 12.1 Selecting a Device, Directory and File</li> <li>- 12.2 Transferring a File</li> <li>- 12.8.2 List of File Names</li> <li>- 12.9 Performing Batch Backups of NC Memory Data</li> </ul> <p>Also, corrected wrong indications.</p> |
|                  |                 |                                                                                                                                                                                                                                                                                                                                                                                                                                                                                                                                                                                                                                                                                                                                                                                                                                                                                                                                                                                                                                                                                                                                                                                                         |



# Global Service Network

## AMERICA

### **MITSUBISHI ELECTRIC AUTOMATION INC. (AMERICA FA CENTER)**

**Central Region Service Center (Chicago)**  
500 CORPORATE WOODS PARKWAY, VERNON HILLS, ILLINOIS 60061, U.S.A.  
TEL: +1-847-478-2500 / FAX: +1-847-478-2650  
**Minneapolis, MN Service Satellite**  
**Detroit, MI Service Satellite**  
**Grand Rapids, MI Service Satellite**  
**Lima, OH Service Satellite**  
**Cleveland, OH Service Satellite**  
**Indianapolis, IN Service Satellite**  
**St. Louis, MO Service Satellite**

**South/East Region Service Center (Georgia)**  
1645 SATELLITE BOULEVARD STE. 450, DULUTH, GEORGIA 30097, U.S.A.  
TEL: +1-678-258-4529 / FAX: +1-678-258-4519  
**Charleston, SC Service Satellite**  
**Charlotte, NC Service Satellite**  
**Raleigh, NC Service Satellite**  
**Dallas, TX Service Satellite**  
**Houston, TX Service Satellite**  
**Hartford, CT Service Satellite**  
**Knoxville, TN Service Satellite**  
**Nashville, TN Service Satellite**  
**Baltimore, MD Service Satellite**  
**Pittsburg, PA Service Satellite**  
**Newark, NJ Service Satellite**  
**Syracuse, NY Service Satellite**  
**Ft. Lauderdale, FL Service Satellite**  
**Lafayette, LA Service Satellite**

**Western Region Service Center (California)**  
5900-B KATELLA AVE. - 5900-A KATELLA AVE. CYPRESS, CALIFORNIA 90630, U.S.A.  
TEL: +1-714-699-2625 / FAX: +1-847-478-2650  
**San Francisco, CA Service Satellite**  
**Seattle, WA Service Satellite**  
**Denver, CO Service Satellite**

**Canada Region Service Center (Toronto)**  
4299 14TH AVENUE MARKHAM, ONTARIO L3R 0J2, CANADA  
TEL: +1-905-754-3805 / FAX: +1-905-475-7935  
**Edmonton, AB Service Satellite**  
**Montreal, QC Service Satellite**

**Mexico Region Service Center (Querétaro)**  
Parque Tecnológico Innovación Querétaro, Lateral Carretera Estatal 431, Km 2+200, Lote 91 Modulos 1 y 2  
Hacienda la Machorra, CP 76246, El Marqués, Querétaro, Mexico  
TEL: +52-442-153 4250  
**Monterrey, NL Service Satellite**  
**Mexico City, DF Service Satellite**  
**Aguascalientes, AGS, Service Satellite**

## BRAZIL

### **MITSUBISHI ELECTRIC DO BRASIL COMÉRCIO E SERVIÇOS LTDA.**

**Votorantim Office**  
AV. GISELE CONSTANTINO, 1578. PARQUE BELA VISTA, VOTORANTIM-SP, BRAZIL. CEP: 18.110-650  
TEL: +55-15-3023-9000  
**Blumenau Santa Catarina office**  
**MAQSERVICE – Canoas, RS Service Satellite**

## EUROPE

### **MITSUBISHI ELECTRIC EUROPE B.V.**

**European Service Headquarters (Dusseldorf, GERMANY)**  
Mitsubishi-Electric-Platz 1 40882 RATINGEN, GERMANY  
TEL: +49-2102-486-5000 / FAX: +49-2102-486-5910

**South Germany Service Center (Stuttgart)**  
SCHELMENWASENSTRASSE 16-20, 70567 STUTTGART, GERMANY  
TEL: +49-711-770598-123 / FAX: +49-711-770598-141

**France Service Center (Paris)**  
25, BOULEVARD DES BOUVETS, 92741 NANTERRE CEDEX FRANCE  
TEL: +33-1-41-02-83-13 / FAX: +33-1-49-01-07-25

**France Service Satellite (Lyon)**  
120, ALLEE JACQUES MONOD 69800 SAINT PRIEST FRANCE  
TEL: +33-1-41-02-83-13 / FAX: +33-1-49-01-07-25

**Italy Service Center (Milan)**  
PALAZZO SIRIO INGRESSO 1, VIA COLLEONI, 7, 20864 AGRATE BRIANZA(MI), ITALY  
TEL: +39-039-6053-342 / FAX: +39-039-6053-206

**Italy Service Satellite (Padova)**  
VIA G. SAVELLI, 24 - 35129 PADOVA, ITALY  
TEL: +39-039-6053-342 / FAX: +39-039-6053-206

**U.K. Service Center**  
TRAVELLERS LANE, HATFIELD, HERTFORDSHIRE, AL10 8XB, U.K.  
TEL: +49-2102-486-5000 / FAX: +49-2102-486-5910

**Spain Service Center**  
CTRA. RUBI, 76-80 8174 SAINT CUGAT DEL VALLES, BARCELONA SPAIN  
TEL: +34-935-65-2236 / FAX: +34-935-89-1579

**Poland Service Center**  
UL.KRAKOWSKA 50, 32-083 BALICE, POLAND  
TEL: +48-12-347-6500 / FAX: +48-12-630-4701

**Hungary Service Center**  
MADARASZ IRODAPARK, MADARASZ VIKTOR UT 47-49, 1138 BUDAPEST, HUNGARY  
TEL: +48-12-347-6500 / FAX: +48-12-630-4701

**Turkey Service Center**  
**MITSUBISHI ELECTRIC TURKEY A.S**  
SERIFALI MAHALLESİ NUTUK SOKAK. NO.41 34775  
UMRANIYE, ISTANBUL, TURKEY  
TEL: +90-216-969-2500 / FAX: +90-216-526-3995

**Czech Republic Service Center**  
**AutoCont Control Systems s.r.o (Service Partner)**  
KAFKOVA 1853/3, 702 00 OSTRAVA 2, CZECH REPUBLIC  
TEL: +420-59-5691-185 / FAX: +420-59-5691-199

**Russia Service Center**  
**MITSUBISHI ELECTRIC RUSSIA LLC**  
LETNIKOVSKAYA STREET 2, BLD.1, 5TH 115114 MOSCOW, RUSSIA  
TEL: +7-495-721-2070 / FAX: +7-495-721-2071

**Sweden Service Center**  
HAMMARBACKEN 14, P.O.BOX 750 SE-19127, SOLLENTUNA, SWEDEN  
TEL: +46-8-6251000 / FAX: +46-8-966877

**Bulgaria Service Center**  
**AKHNATON Ltd. (Service Partner)**  
4 ANDREJ LJAPCHEV BLVD. POB 21, BG-1756 SOFIA, BULGARIA  
TEL: +359-2-8176009 / FAX: +359-2-9744061

**Ukraine Service Center (Kiev)**  
**CSC Automation Ltd. (Service Partner)**  
4 B. YEVHENA SVERSTYUKA STR., 02002 KIEV, UKRAINE  
TEL: +380-44-494-3344 / FAX: +380-44-494-3366

**Belarus Service Center**  
**TECHNIKON Ltd. (Service Partner)**  
NEZAVISIMOSTI PR.177, 220125 MINSK, BELARUS  
TEL: +375-17-393-1177 / FAX: +375-17-393-0081

**South Africa Service Center**  
**MOTIONTRONIX (Service Partner)**  
P.O. BOX 9234, EDLEEN, KEMPTON PARK GAUTENG, 1625, SOUTH AFRICA  
TEL: +27-11-394-8512 / FAX: +27-11-394-8513

**ASEAN****MITSUBISHI ELECTRIC ASIA PTE. LTD. (ASEAN FA CENTER)**

**Singapore Service Center**  
307 ALEXANDRA ROAD #05-01/02 MITSUBISHI ELECTRIC BUILDING SINGAPORE 159943  
TEL: +65-6473-2308 / FAX: +65-6476-7439

**Philippines Service Center**  
Flexible Automation system corporation (Service Partner)  
UNIT NO.411, ALABAMG CORPORATE CENTER KM 25. WEST SERVICE ROAD  
SOUTH SUPERHIGHWAY, ALABAMG MUNTINLUPA METRO MANILA, PHILIPPINES 1771  
TEL: +63-2-807-2416 / FAX: +63-2-807-2417

**VIETNAM****MITSUBISHI ELECTRIC VIETNAM CO.,LTD.**

**Vietnam Ho Chi Minh Service Center**  
UNIT 01-04, 10TH FLOOR, VINCOM CENTER 72 LE THANH TON STREET, DISTRICT1,  
HO CHI MINH CITY, VIETNAM  
TEL: +84-28-3910 5945 / FAX: +84-28-3910 5947

**Vietnam Hanoi Service Center**  
24TH FLOOR, HANDICO TOWER, PHAM HUNG ROAD, ME TRI HA, ME TRI WARD,  
NAM TU LIEM DISTRICT, HA NOI CITY, VIETNAM  
TEL: +84-24-3937-8075 / FAX: +84-24-3937-8076

**INDONESIA****PT. MITSUBISHI ELECTRIC INDONESIA**

**Indonesia Service Center (Cikarang)**  
JL. KENARI RAYA BLOK G2-07A, DELTA SILICON 5, LIPPO CIKARANG - BEKASI 17550, INDONESIA  
TEL: +62-21-2961-7797 / FAX: +62-21-2961-7794

**MALAYSIA****MITSUBISHI ELECTRIC SALES MALAYSIA SDN. BHD.**

**Malaysia Service Center (Kuala Lumpur Service Center)**  
LOT 11, JALAN 219, P. O BOX 1036, 46960 PETALING JAYA, SELANGOR DARUL EHSAN. MALAYSIA  
TEL: +60-3-7960-2628 / FAX: +60-3-7960-2629  
**Johor Bahru Service Satellite**

**THAILAND****MITSUBISHI ELECTRIC FACTORY AUTOMATION (THAILAND) CO.,LTD.**

**Thailand Service Center (Bangkok)**  
12TH FLOOR, SV.CITY BUILDING, OFFICE TOWER 1, NO. 896/19 AND 20 RAMA 3 ROAD,  
KWAENG BANGPONGPANG, KHET YANNAWA, BANGKOK 10120,THAILAND  
TEL: +66-2-682-6522 / FAX: +66-2-682-6020  
**Bowin Service Center (Chonburi)**  
**Korat Service Center**

**INDIA****MITSUBISHI ELECTRIC INDIA PVT., LTD.**

**CNC Technical Center (Bangalore)**  
PLOT NO. 56, 4TH MAIN ROAD, PEENYA PHASE 3,  
PEENYA INDUSTRIAL AREA, BANGALORE 560058, KARNATAKA, INDIA  
TEL : +91-80-4655-2121 / FAX : +91-80-4655-2147

**Chennai Service Satellite**  
**Coimbatore Service Satellite**  
**Hyderabad Service Satellite**

**North India Service Center (Gurgaon)**  
2ND FLOOR, TOWER A&B, DLF CYBER GREENS, DLF CYBER CITY,  
DLF PHASE-III, GURGAON- 122 002, HARYANA, INDIA  
TEL : +91-124-4630 300 / FAX : +91-124-4630 399

**Ludhiana Service Satellite**  
**Panthenagar Service Satellite**  
**Delhi Service Satellite**  
**Jamshedpur Service Satellite**  
**Manesar Service Satellite**

**West India Service Center (Pune)**  
ICC-Devi GAURAV TECHNOLOGY PARK, UNIT NO.402, FOURTH FLOOR, NORTH WING,  
SURVEY NUMBER 191-192 (P), NEXT TO INDIAN CARD CLOTHING COMPANY Ltd,  
OPP. VALLABH NAGAR, PIMPRI, PUNE- 411 018, MAHARASHTRA, INDIA  
TEL : +91-20-6819 2274 / FAX : +91-20-4624 2100

**Kolhapur Service Satellite**  
**Aurangabad Service Satellite**  
**Mumbai Service Satellite**

**West India Service Center (Ahmedabad)**  
204-209, 2ND FLOOR, 31FIVE, CORPORATE ROAD PRAHLADNAGAR,  
AHMEDABAD -380015, GUJARAT, INDIA  
TEL : + 91-79-6777 7888  
**Rajkot Service Satellite**

**CHINA****MITSUBISHI ELECTRIC AUTOMATION (CHINA) LTD. (CHINA FA CENTER)**

**China Shanghai Service Center**  
1-3,5-10,18-23/F, NO.1386 HONG QIAO ROAD, CHANG NING QU,  
SHANGHAI 200336, CHINA  
TEL: +86-21-2322-3030 / FAX: +86-21-2322-3000\*8422

**China Qingdao Service Center**  
**China Suzhou Service Center**  
**China Wuhan Service Center**  
**China Ningbo Service Center**  
**China Ningbo Service Partner**  
**China Jinan Service Partner**  
**China Hangzhou Service Partner**  
**China Suzhou Service Partner**

**China Beijing Service Center**  
5/F, ONE INDIGO, 20 JIUXIANQIAO ROAD CHAOYANG DISTRICT,  
BEIJING 100005, CHINA  
TEL: +86-10-6518-8830 / FAX: +86-10-6518-2938  
**China Beijing Service Partner**

**China Tianjin Service Center**  
UNIT 2003, TIANJIN CITY TOWER, NO 35 YOUYI ROAD, HEXI DISTRICT,  
TIANJIN 300061, CHINA  
TEL: +86-22-2813-1015 / FAX: +86-22-2813-1017

**China Xian Service Center**  
**China Changchun Service Partner**

**China Chengdu Service Center**  
1501-1503, 15F, GUANG-HUA CENTRE BUILDING-C, NO.98 NORTH GUANG HUA 3th RD,  
CHENGDU, 610000, CHINA  
TEL: +86-28-8446-8030 / FAX: +86-28-8446-8630

**China Shenzhen Service Center**  
LEVEL8, GALAXY WORLD TOWER B, 1 YABAO ROAD, LONGGANG DISTRICT,  
SHENZHEN 518129, CHINA  
TEL: +86-755-2399-8272 / FAX: +86-755-8229-3686

**China Dongguan Service Center**  
**China Dongguan Service Partner**  
**China Xiamen Service Partner**

**China Dalian Service Center**  
DONGBEI 3-5, DALIAN ECONOMIC & TECHNICAL DEVELOPMENTZONE, LIAONING PROVINCE,  
116600, CHINA  
TEL: +86-411-8765-5951 / FAX: +86-411-8765-5952

**KOREA****MITSUBISHI ELECTRIC AUTOMATION KOREA CO., LTD. (KOREA FA CENTER)**

**Korea Service Center**  
8F GANGSEO HANGANG XI-TOWER A, 401 YANGCHEON-RO, GANGSEO-GU,  
SEOUL 07528 KOREA  
TEL: +82-2-3660-9609 / FAX: +82-2-3664-8668  
**Korea Daegu Service Satellite**

**TAIWAN****MITSUBISHI ELECTRIC TAIWAN CO., LTD. (TAIWAN FA CENTER)**

**Taiwan Taichung Service Center**  
NO.8-1, INDUSTRIAL 16TH RD., TAICHUNG INDUSTRIAL PARK, SITUN DIST.,  
TAICHUNG CITY 40768, TAIWAN  
TEL: +886-4-2359-0688 / FAX: +886-4-2359-0689

**Taiwan Taipei Service Center**  
10F, NO.88, SEC.6, CHUNG-SHAN N. RD., SHI LIN DIST., TAIPEI CITY 11155, TAIWAN  
TEL: +886-2-2833-5430 / FAX: +886-2-2833-5433

**Taiwan Tainan Service Center**  
11F-1., NO.30, ZHONGZHENG S. ROAD, YONGKANG DISTRICT, TAINAN CITY 71067, TAIWAN  
TEL: +886-6-252-5030 / FAX: +886-6-252-5031

**OCEANIA****MITSUBISHI ELECTRIC AUSTRALIA PTY. LTD.**

**Oceania Service Center**  
348 VICTORIA ROAD, RYDALMERE, N.S.W. 2116 AUSTRALIA  
TEL: +61-2-9684-7269/ FAX: +61-2-9684-7245

**Notice**

Every effort has been made to keep up with software and hardware revisions in the contents described in this manual. However, please understand that in some unavoidable cases simultaneous revision is not possible.

Please contact your Mitsubishi Electric dealer with any questions or comments regarding the use of this product.

**Duplication Prohibited**

This manual may not be reproduced in any form, in part or in whole, without written permission from Mitsubishi Electric Corporation.

COPYRIGHT 2015-2019 MITSUBISHI ELECTRIC CORPORATION  
ALL RIGHTS RESERVED

mitsubishi cnc

**MITSUBISHI ELECTRIC CORPORATION**

HEAD OFFICE : TOKYO BLDG.,2-7-3 MARUNOUCHI,CHIYODA-KU,TOKYO 100-8310,JAPAN

|            |                     |
|------------|---------------------|
| MODEL      | M800/M80/E80 Series |
| MODEL CODE | 100-439             |
| Manual No. | IB-1501274          |